

High Sensitivity Omni-Polar Hall Effect Switch

TO-92S



Pin Definition:

1. V_{CC}
2. GND
3. Output

SOT-23



Pin Definition:

1. V_{CC}
2. Output
3. GND

Description

TSH253 Hall-effect sensor is a temperature stable, stress-resistant switch. Superior high-temperature performance is made possible through a dynamic offset cancellation that utilizes chopper-stabilization. This method reduces the offset voltage normally caused by device over molding, temperature dependencies, and thermal stress. TSH253 includes the following on a single silicon chip: voltage regulator, Hall voltage generator, small-signal amplifier, chopper stabilization, Schmitt trigger, open-drain output. Advanced CMOS wafer fabrication processing is used to take advantage of low-voltage requirements, component matching, very low input-offset errors, and small component geometries.

Features

- CMOS Hall IC Technology
- Solid-State Reliability much better than reed switch
- Omni polar output switches with absolute value of North or South pole from magnet
- Operation down to 1.8 V and Max at 6V.
- High Sensitivity for reed switch replacement
- ESD HBM ±4KV Min

Ordering Information

Part No.	Package	Packing
TSH253CT B0G	TO-92S	1Kpcs / Bulk Bag
TSH253CX RFG	SOT-23	3Kpcs / 7" Reel

Note: "G" denote for Halogen Free Product

Application

- Solid state switch, Revolution counter
- Lid close sensor for power supply devices
- Magnet proximity sensor for reed switch replacement in high duty cycle applications.
- Safety Key on sporting equipment
- Speed sensor, Position Sensor, Rotation Sensor

Absolute Maximum Rating (T_a = 25°C unless otherwise noted)

Characteristics	Limit	Value	Unit
Supply voltage	V _{CC}	6	V
Output Voltage	V _{OUT}	6	V
Reverse voltage	V _{CC/OUT}	-0.3	V
Magnetic flux density		Unlimited	Gauss
Output current	I _{OUT}	1	mA
Operating Temperature Range	T _{OPR}	-40 to +85	°C
Storage temperature range	T _{STG}	-55 to +150	°C
Maximum Junction Temp	T _J	150	°C
Thermal Resistance - Junction to Ambient	TO-92S	206	°C/W
	SOT-23	543	
Thermal Resistance - Junction to Case	TO-92S	148	°C/W
	SOT-23	410	
Package Power Dissipation	TO-92S	606	mW
	SOT-23	230	

Note: Exceeding the absolute maximum ratings may cause permanent damage. Exposure to absolute maximum-rated conditions for extended periods may affect device reliability.

High Sensitivity Omni-Polar Hall Effect Switch

Block Diagram

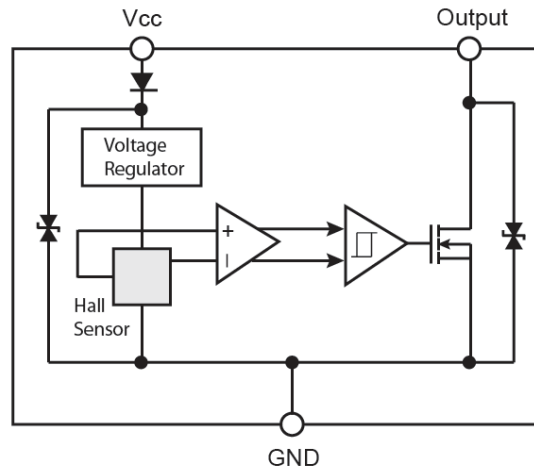

Note: Static sensitive device; please observe ESD precautions. Reverse VDD protection is not included. For reverse voltage protection, a 100Ω resistor in series with VDD is recommended.

Typical Application Circuit

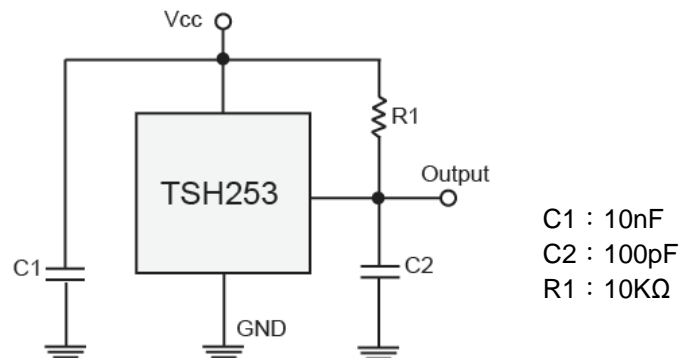

Electrical Specifications (DC Operating Parameters : $T_A=+25^{\circ}\text{C}$, $V_{CC}=5\text{V}$)

Parameters	Test Conditions	Min	Typ	Max	Units
Supply Voltage	Operating	1.8	--	6	V
Supply Current	Average	--	2.6	6.0	mA
Output Low Voltage	$I_{OUT}=0.5\text{mA}$	--	--	200	mV
Output Leakage Current	$I_{OFF} \quad B < B_{RP}, \quad V_{OUT} = 3\text{V}$	--	--	10	uA
Output Rise Time	$R_L=10\text{k}\Omega, \quad C_L=20\text{pF}$	--	--	0.45	uS
Output Fall Time	$R_L=10\text{k}\Omega; \quad C_L=20\text{pF}$	--	--	0.45	uS
Electro-Static Discharge	HBM	4	--	--	KV

Magnetic Specifications (TSH253CT)

Parameter	Symbol	Test Conditions	Min.	Typ.	Max.	Units
Operating Point	B _{OPS}	S pole to branded side, B > B _{OP} , Vout On		30	60	Gauss
	B _{OPN}	N pole to branded side, B > B _{OP} , Vout On	-60	-30		Gauss
Release Point	B _{RPS}	S pole to branded side, B < B _{RP} , Vout Off	5	25		Gauss
	B _{RPN}	N pole to branded side, B < B _{RP} , Vout Off		-25	-5	Gauss
Hysteresis	B _{HYS}	BOPx - BRPx		5		Gauss

Note: 1G (Gauss) = 0.1mT (millitesta)

Magnetic Specifications (TSH253CX)

Parameter	Symbol	Test Conditions	Min.	Typ.	Max.	Units
Operating Point	B _{OPS}	N pole to branded side, B > B _{OP} , Vout On	--	30	60	Gauss
	B _{OPN}	S pole to branded side, B > B _{OP} , Vout On	-60	-30	--	Gauss
Release Point	B _{RPS}	N pole to branded side, B < B _{RP} , Vout Off	5	25	--	Gauss
	B _{RPN}	S pole to branded side, B < B _{RP} , Vout Off	--	-25	-5	Gauss
Hysteresis	B _{HYS}	BOPx - BRPx	--	5	--	Gauss

Note: 1G (Gauss) = 0.1mT (millitesta)

Output Behavior versus Magnetic Pole

DC Operating Parameters: T_A = -40 to 125°C, V_{CC} = 1.8V ~ 6V

Parameter	Test condition	OUT
South pole	B < Bop[(-60)~(-5)]	Low
Null or weak magnetic field	B=0 or B < BRP	Open(Pull-up Voltage)
North pole	B > Bop(60~5)	Low

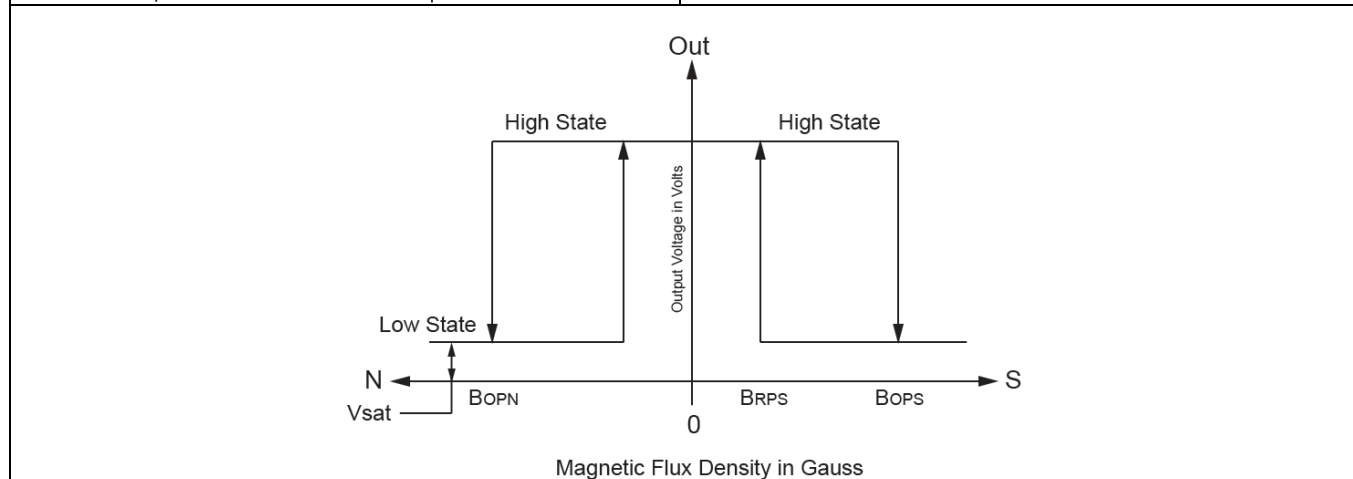
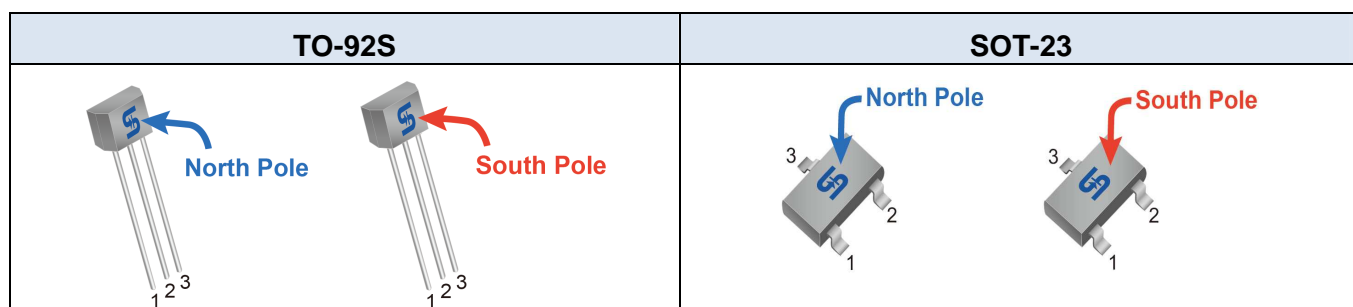

Characteristic Performance

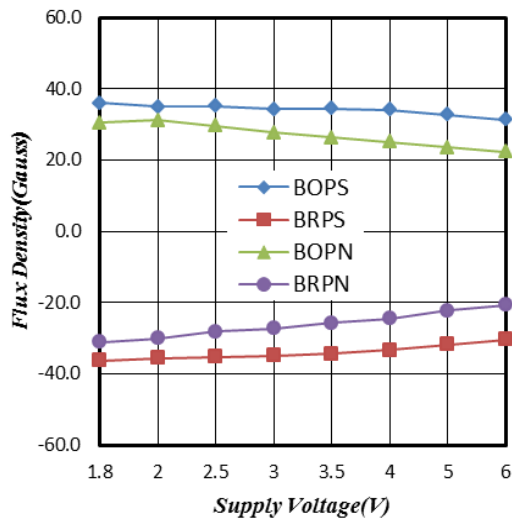

Figure 1. Supply Voltage vs. Flux Density

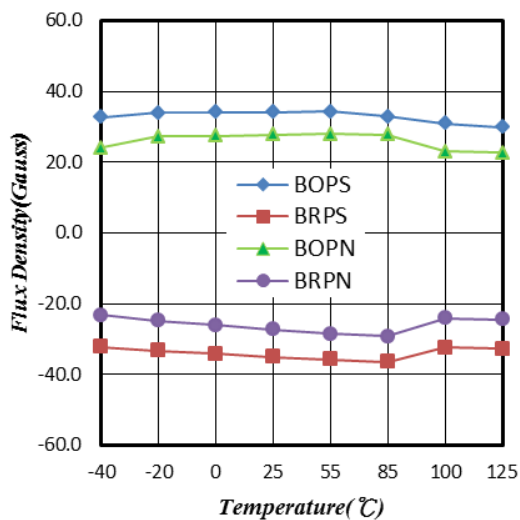

Figure 2. Temperature vs. Flux Density

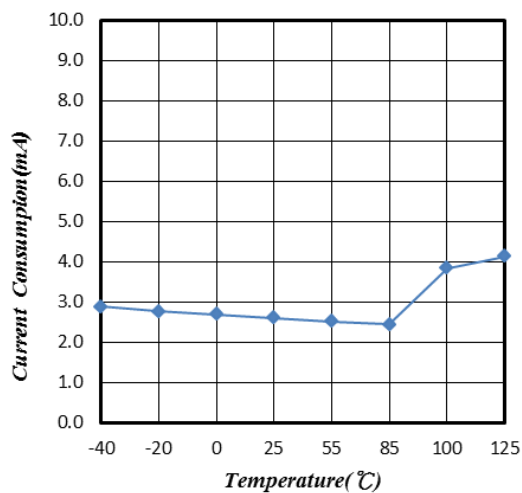

Figure 3. Supply Current vs. Temperature

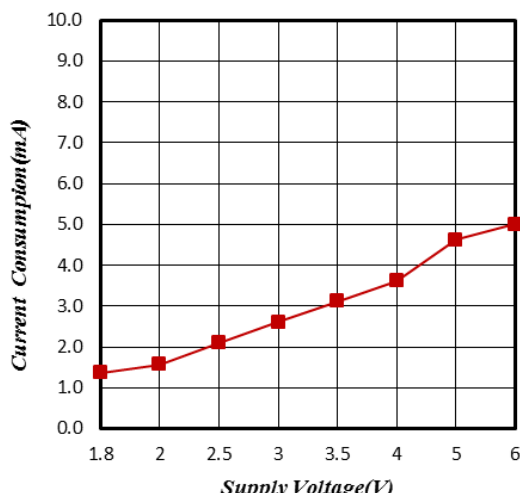

Figure 4. Supply Current vs. Supply Voltage

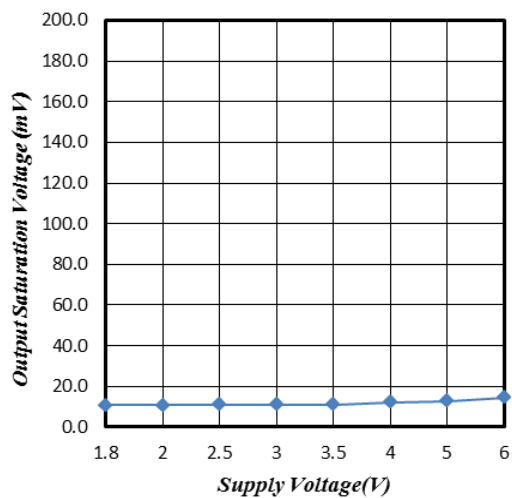

Figure 5. Output Saturation Voltage vs. Supply Voltage

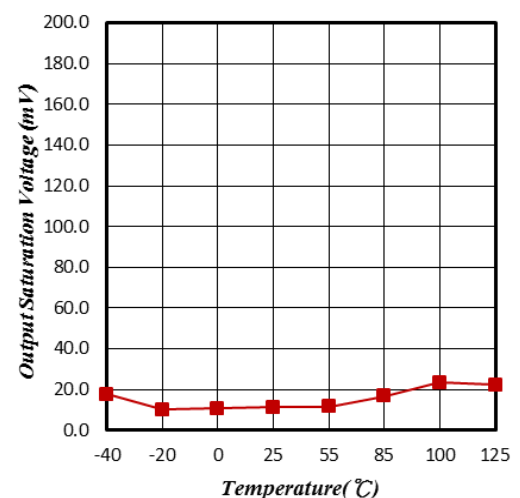

Figure 6. Output Saturation Voltage vs. Temperature

Characteristic Performance

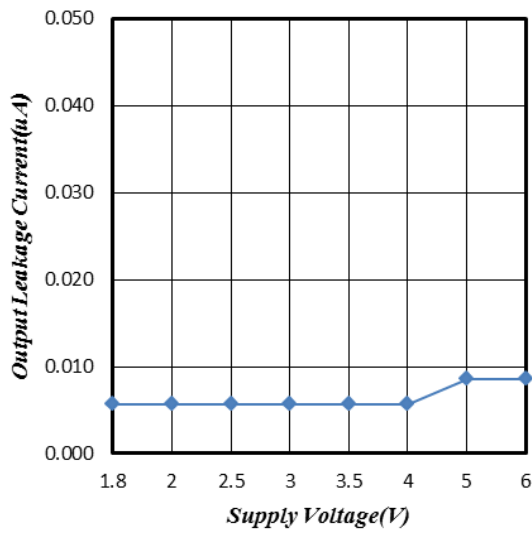

Figure 7. Output Leakage Current vs. Supply Voltage

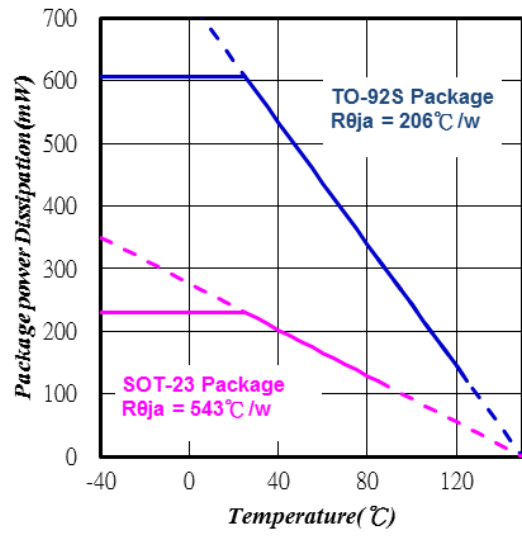
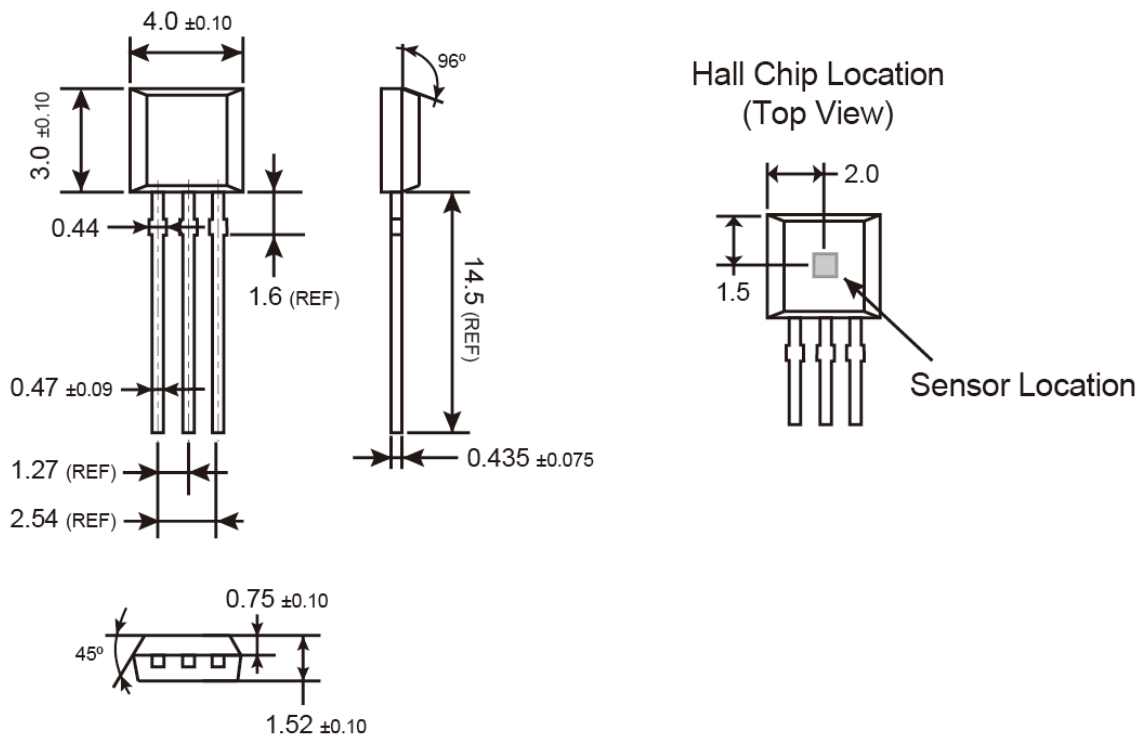

Figure 8. Power Dissipation vs. Temperature

TO-92S Mechanical Drawing



Unit: Millimeters

Marking Diagram

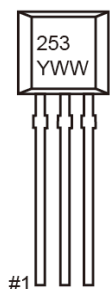

253 = Device Code
Y = Year Code (3=2013, 4=2014....)
WW = Week Code (01~52)

SOT-23 Mechanical Drawing

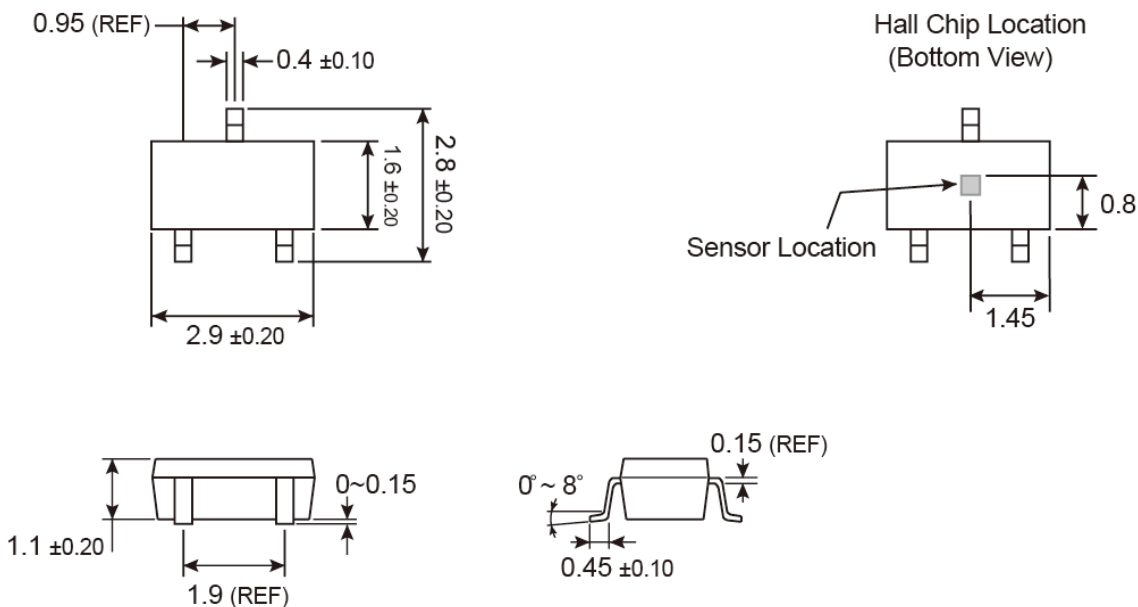

Unit: Millimeters

Marking Diagram

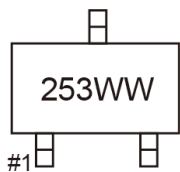

253 = Device Code
WW = Week Code Table

week	1	2	3	4	5	6	7	8	9	10	11	12	13
code	OA	OB	OC	OD	OE	OF	OG	OH	OI	OJ	OK	OL	OM
week	14	15	16	17	18	19	20	21	22	23	24	25	26
code	ON	OO	OP	OQ	OR	OS	OT	OU	OV	OW	OX	OY	OZ
week	27	28	29	30	31	32	33	34	35	36	37	38	39
code	PA	PB	PC	PD	PE	PF	PG	PH	PI	PJ	PK	PL	PM
week	40	41	42	43	44	45	46	47	48	49	50	51	52
code	PN	PO	PP	PQ	PR	PS	PT	PU	PV	PW	PX	PY	PZ

Notice

Specifications of the products displayed herein are subject to change without notice. TSC or anyone on its behalf, assumes no responsibility or liability for any errors or inaccuracies.

Information contained herein is intended to provide a product description only. No license, express or implied, to any intellectual property rights is granted by this document. Except as provided in TSC's terms and conditions of sale for such products, TSC assumes no liability whatsoever, and disclaims any express or implied warranty, relating to sale and/or use of TSC products including liability or warranties relating to fitness for a particular purpose, merchantability, or infringement of any patent, copyright, or other intellectual property right.

The products shown herein are not designed for use in medical, life-saving, or life-sustaining applications. Customers using or selling these products for use in such applications do so at their own risk and agree to fully indemnify TSC for any damages resulting from such improper use or sale.