

Specification

EWT801-S

CUSTOMER

Checked by	Approved by

SUPPLIER

Drawn by	Approved by

EWT801-S

1. Description
2. Absolute Maximum Ratings
3. Electro-Optical Characteristics
4. Characteristic Diagram
5. Reliability Test Item and Condition
6. Rank of EWT801-S
7. Package Dimension
8. Material
9. Packing
10. Soldering
11. Precaution for use
12. Handling of Silicone Resin LEDs
13. Revision History

EWT801-S

1. Description

This surface-mount LED comes in PLCC standard package dimension. It has a substrate made up of a molded plastic reflector sitting on top of a bent lead frame. The die is attached within the reflector cavity and the cavity is encapsulated by silicon.

The package design coupled with careful selection of component materials allow these products to perform with high reliability in a larger temperature range -40°C to 110°C. The high reliability feature is crucial to Automotive interior and Indoor ESS.



Features

- Package :
White PLCC2
White Color
- View Angle : 120°
- Technology : InGaN/GaN
- MSL : 2a
- Reflow : Pb-free Reflow
- ESD : min 2kV
- RoHS : Compliant

Applications

- Interior automotive
- Electronic Signs and Signals
- Office Automation, Electrical Appliances, Industrial Equipment

2. Absolute Maximum Ratings

Parameter	Symbol	Value	Unit
Power Dissipation ($T_a=25^\circ\text{C}$)	P_d	127	mW
Forward Current ($T_a=25^\circ\text{C}$)	I_F	30	mA
Peak Forward Current ($t \leq 10\mu\text{sec}, D \leq 5/1000, T_a=25^\circ\text{C}$)	I_{FM}	300	mA
Reverse Voltage ($I_r=10\mu\text{A}, T_a=25^\circ\text{C}$)	V_R	5	V
Operating Temperature	T_{opr}	-40 ~ +110	$^\circ\text{C}$
Storage Temperature	T_{stg}	-40 ~ +110	$^\circ\text{C}$
Junction Temperature	T_j	125	$^\circ\text{C}$
Soldering Temperature	T_{sld}	Reflow Soldering : 260°C for 10sec. Hand Soldering : 315°C for 4sec.	
ESD ($R=1.5\text{k}\Omega, C=100\text{pF}$)		Min 2	kV

3. Electro-Optical characteristics

Parameter	Symbol	Condition	Min	Typ	Max	Unit
Forward Voltage *1*2	V_F	$I_F=20$ mA	2.7	3.4	4.0	V
Luminous Intensity *3	I_V	$I_F=20$ mA	1120	1680	2240	mcd
Luminous Flux	ϕ_V	$I_F=20$ mA	-	5040	-	lm
Color Coordinate *4	X	$I_F=20$ mA		0.31		-
	Y	$I_F=20$ mA		0.30		-
Viewing Angle *5	$2\theta_{1/2}$	$I_F=20$ mA	-	120	-	deg.
Optical Efficiency	η_{op}	$I_F=20$ mA	-	74.1	-	lm/W
Thermal resistance *6	$R_{th JA}$	$I_F=20$ mA	-	360	-	°C / W
	$R_{th JS}$	$I_F=20$ mA	-	180	-	°C / W
Temperature coefficient of V_F -10°C ≤ T ≤ 100 °C	TC_V	$I_F = 20$ mA	-	-2.64	-	mV/°C
Temperature coefficient of X -10°C ≤ T ≤ 100 °C	TC_x	$I_F = 20$ mA	-	-0.20	-	10 ⁻³ /°C
Temperature coefficient of Y -10°C ≤ T ≤ 100 °C	TC_y	$I_F = 20$ mA	-	-0.22	-	10 ⁻³ /°C
Luminous Intensity Phi V / IV	∂_{ϕ}	$I_F = 20$ mA	3.0		3.1	lm/cd

*1. A tolerance of ±0.05V on forward voltage measurements

*2. 99% yield of forward voltage is 2.8 ~ 3.8V

*3. The luminous intensity IV was measured at the peak of the spatial pattern which may not be aligned with the mechanical axis of the LED package. Luminous Intensity Measurement allowance is ±10%

*4. Color difference between luminous flux and luminous intensity is Color difference : ± 0.01

*5. $2\theta_{1/2}$ is the off-axis where the luminous intensity is 1/2 of the peak intensity.

*6. Thermal resistance = $R_{th JA}$: Junction/ambient , $R_{th JS}$: Junction/solder point

Pad design for improved heat dissipation : Cu-area > Cu 16mm² per pad, FR4, t=1.6mm

4. Characteristic Diagram

Forward Current vs. Forward Voltage

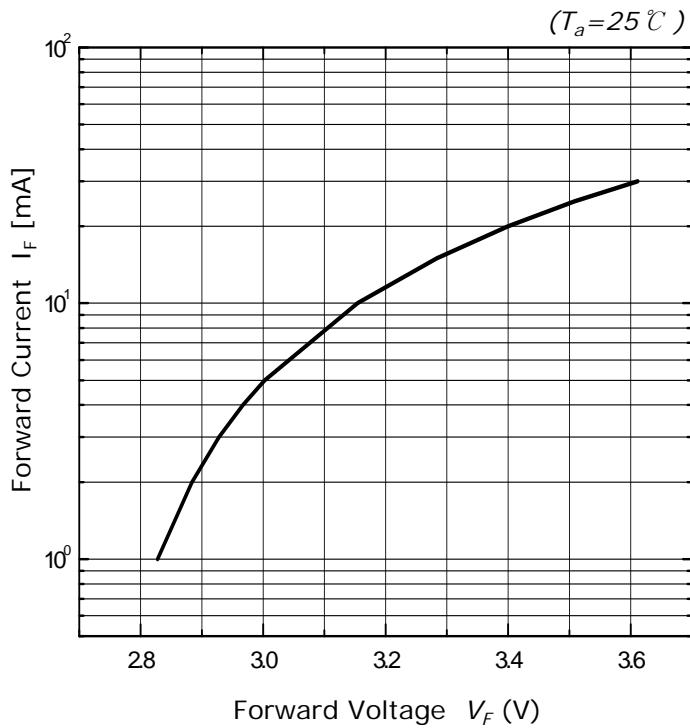

Relative Luminous Intensity vs. Forward Current

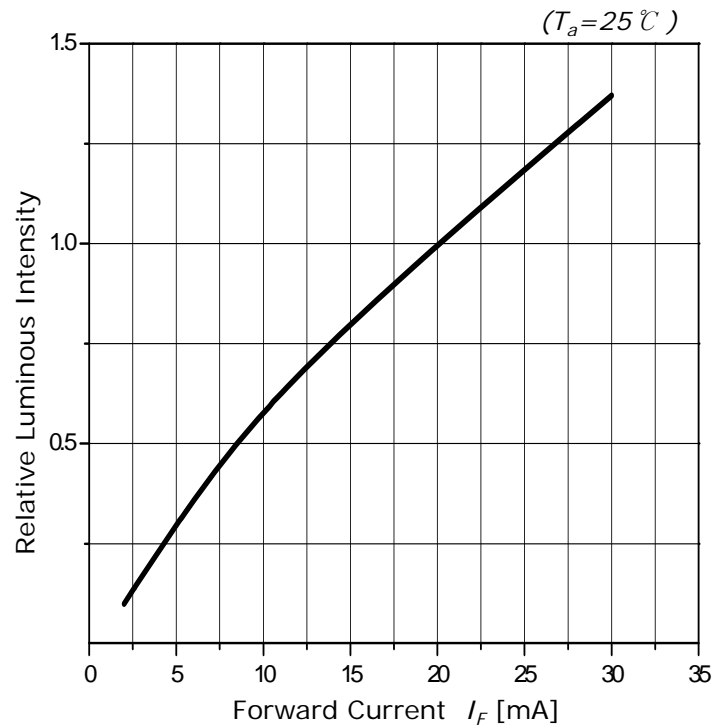

Forward Current vs. Temperature

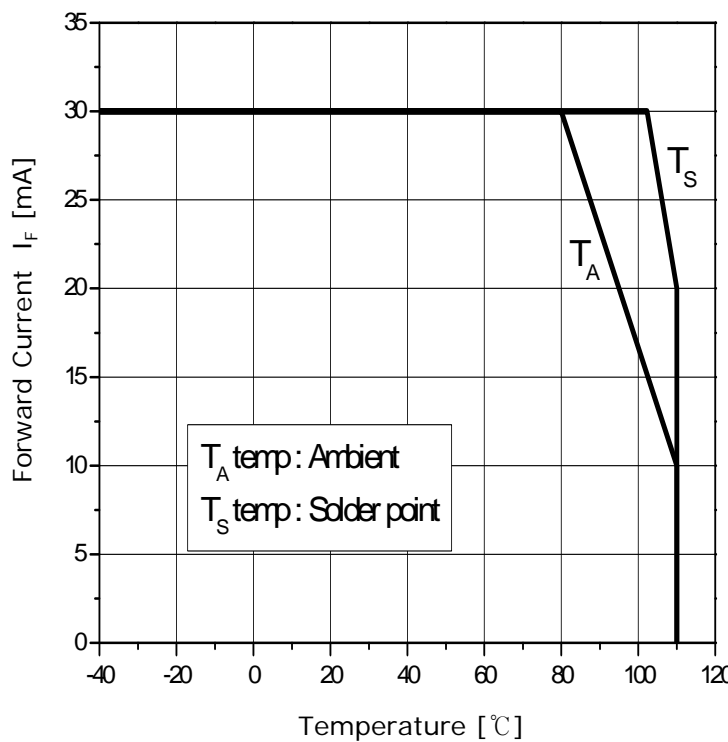

Spectral distribution

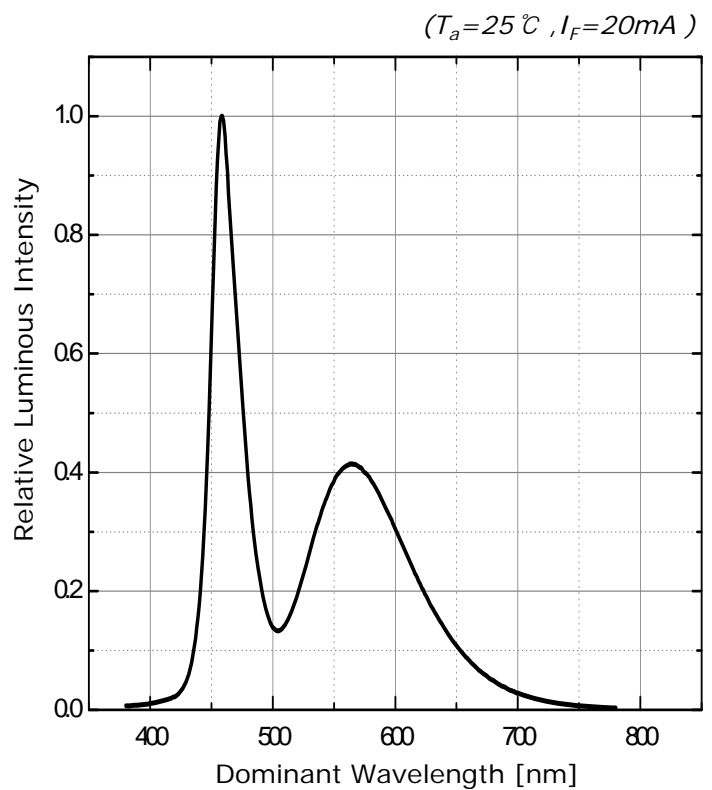

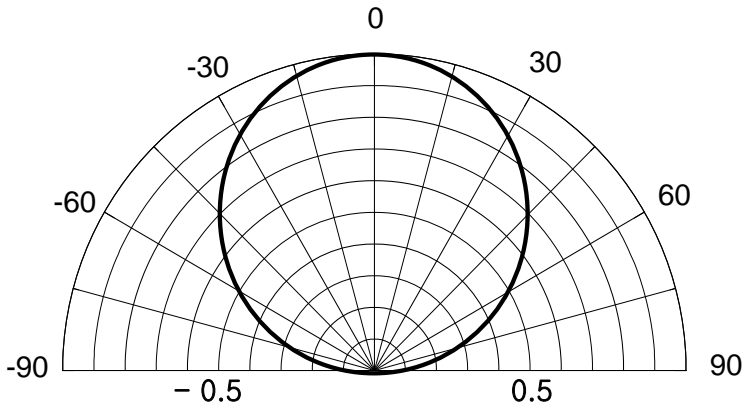
Radiation Diagram
 $(T_a = 25\text{ }^\circ\text{C}, I_F = 20\text{mA})$

Life time

Condition	Life time	Unit
$I_F = 20\text{mA}$ $T_A = 25\text{ }^\circ\text{C}$	30,000	Operating hours
$I_F = 30\text{mA}$ $T_A = 85\text{ }^\circ\text{C}$	7,000	Operating hours

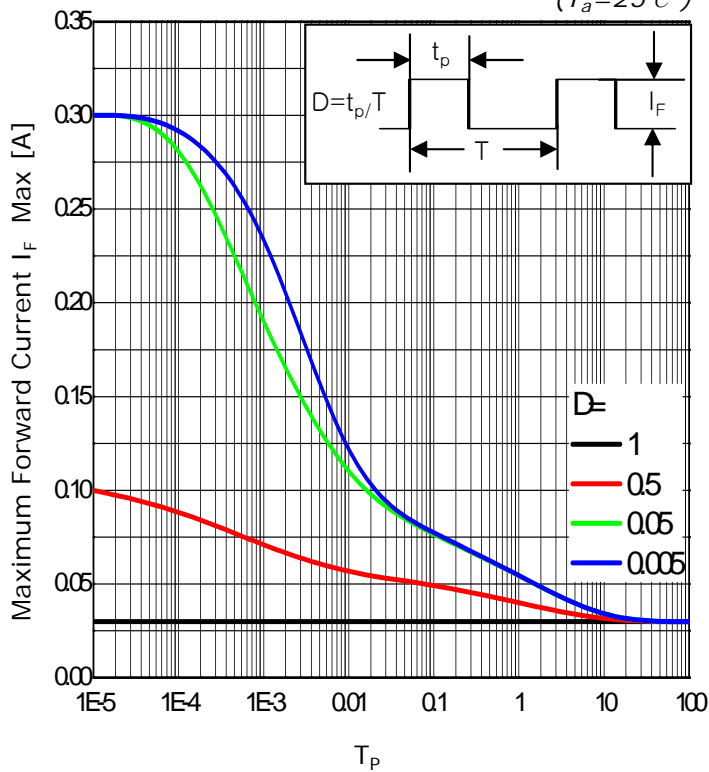
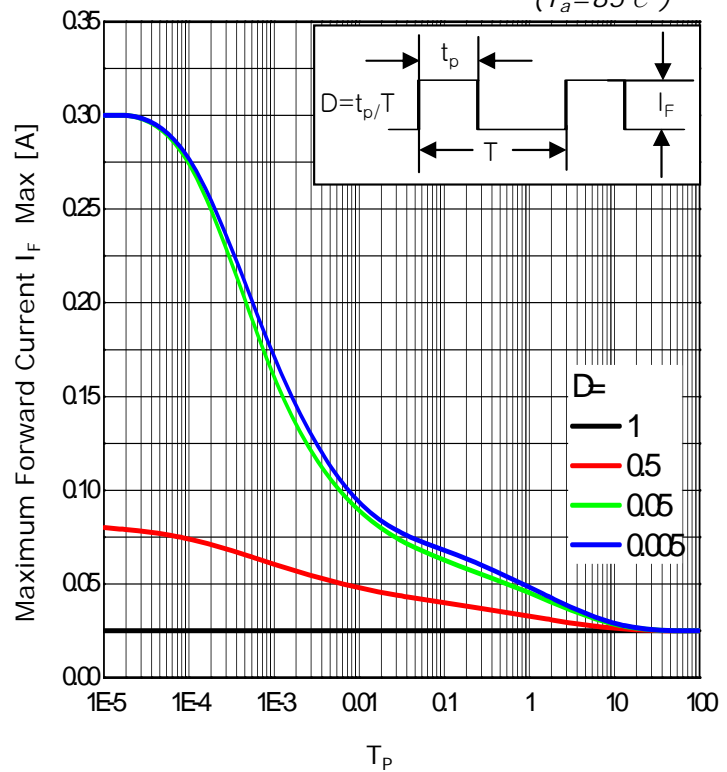
Ref. 1) 50% degradation time of luminous intensity
2) Calculated values from typical data

Forward Current vs. Duty Ratio
 $(T_a = 25\text{ }^\circ\text{C})$

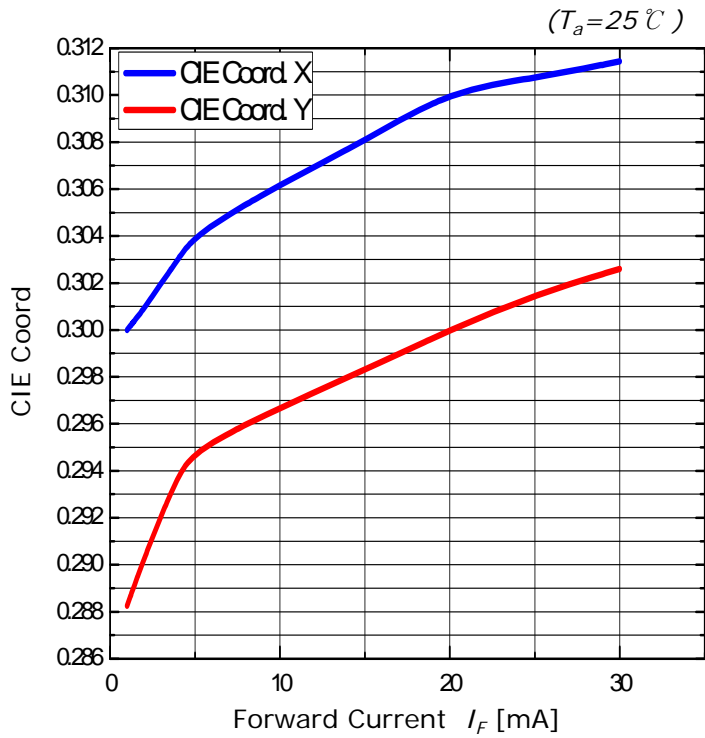
Forward Current vs. Duty Ratio
 $(T_a = 85\text{ }^\circ\text{C})$

Color. vs. Forward Current

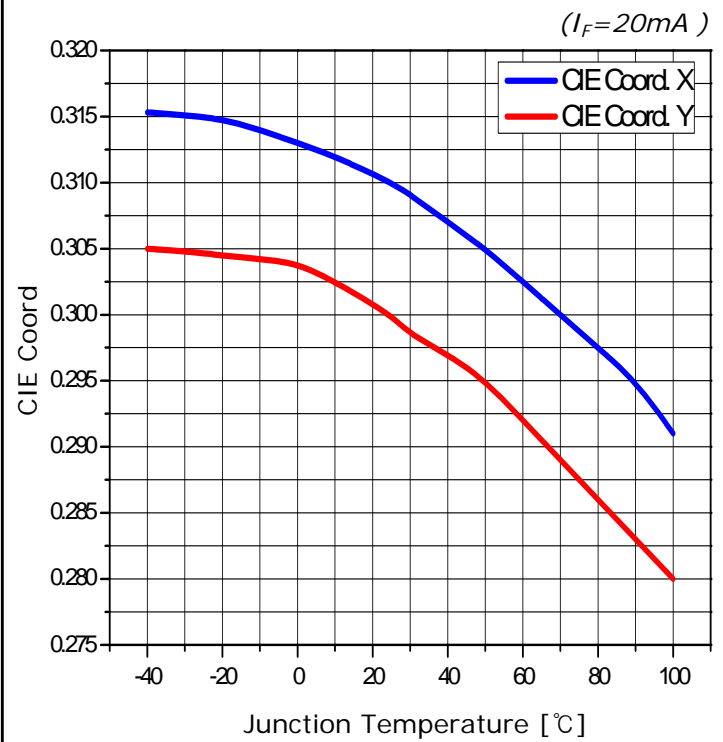

Color. vs. Junction Temperature



Forward Voltage vs. Junction Temperature

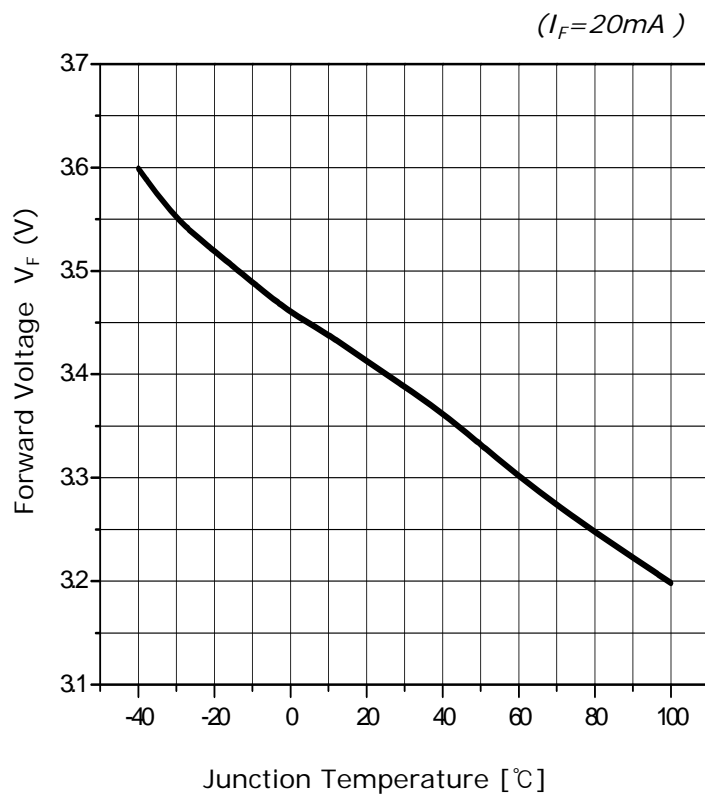

Relative Luminous Intensity vs. Junction Temperature

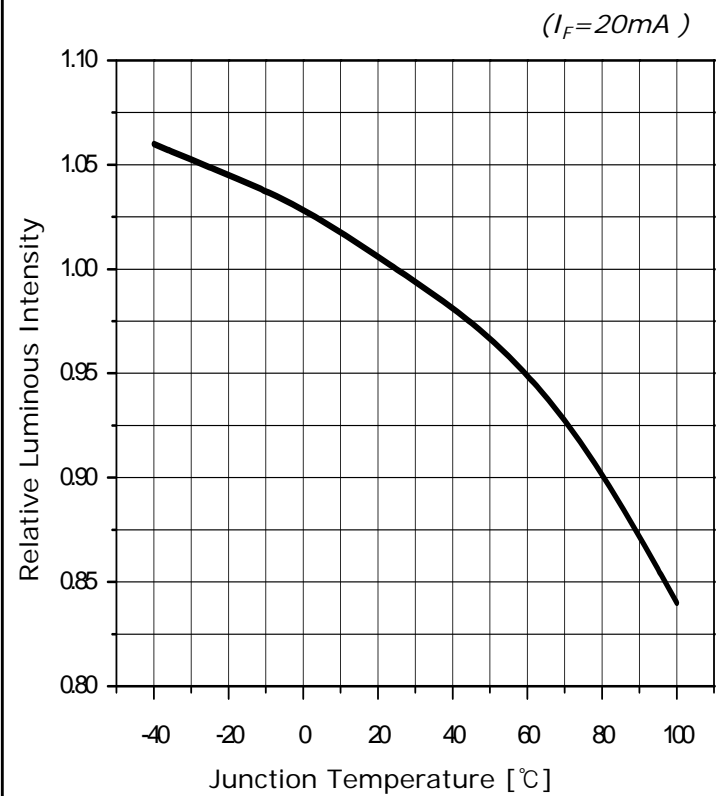

Color. vs. Viewing Angle

$(T_a=25\text{ }^\circ\text{C}, I_F=20\text{mA})$

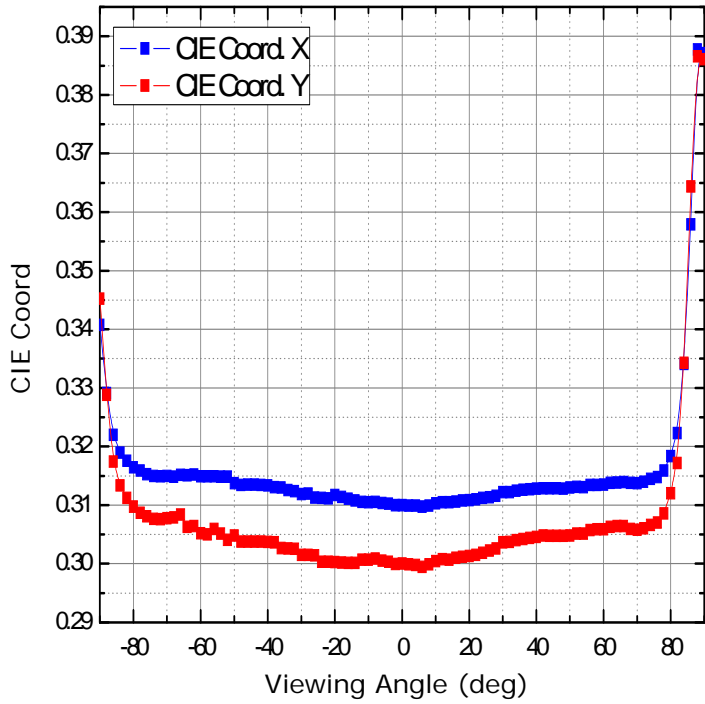

5 Reliability

(1) TEST ITEMS AND RESULTS

Test Item	Standard Test Method	Test Condition	Duration / Cycle	Number of Damage
Resistance to Soldering Heat (Reflow soldering)	JEITA ED-4701 300 301	Tsld=260℃, 10sec. (Pre treatment 30℃,70%,168hrs.)	2 times	0/30
Solderability (Reflow Soldering)	JEITA ED-4701 300 303	Tsld=215±5℃, 3sec. (using flux, Lead Solder)	1 time Over 95%	0/30
Thermal Shock	JEITA ED-4701 300 307	-40℃ ~ 110℃ 20min. (10sec.) 20min.	1000 hrs.	0/77
Temperature Cycle	JEITA ED-4701 100 105	-40℃ ~ 25℃ ~ 110℃ ~ 25℃ 25min. 5min. 25min. 5min	1000 hrs.	0/77
High Temperature Storage	JEITA ED-4701 200 201	T _a = 100℃	1000 hrs.	0/77
Low Temperature Storage	JEITA ED-4701 200 202	T _a = -40℃	1000 hrs.	0/77
Room temperature Operating Life **	Internal Reference	T _a = 25℃, I _F = 30mA	1000 hrs.	0/77
Steady State Operating Life of High Temperature	Internal Reference	T _a = 100℃, I _F = 17mA	1000 hrs.	0/77
Steady State Operating Life of High Humidity Heat	Internal Reference	85℃, RH=85%, I _F = 25mA	1000 hrs.	0/77
Steady State Operating Life of Low Temperature	Internal Reference	T _a = -40℃, I _F = 30mA	1000 hrs.	0/77
Power and Temperature Cycle	JESD22 A-105	T _a = -40℃ (20min) ~ 85℃ (20min) (Transfer time: 20min, 1Cycle=1hr) I _F = 25mA, 2 min. on/off	1000 hrs.	0/77
Vibration	JEITA ED-4701 400 403	200m/s ² , 100~2000Hz (Sweep 4min.) 48min., 3 directions	4 times	0/30
Electrostatic Discharge	JEITA ED-4701 300 304	R=1.5kΩ, C= 100pF Test Voltage = 2kV	3 Times Negative /Positive	0/30

(2) Criteria for Judging the Damage

Item	Symbol	Condition	Criteria for Judgment	
			MIN	MAX
Forward Voltage	V _F	I _F =20mA	-	Initial × 1.2
Luminous Intensity	I _V	I _F =20mA	Initial × 0.8	-

6. Rank of EWT801-S

1) Bin Code Description

[Ta = 25°C, IF = 20mA]

Bin Code		
Forward Voltage	Luminous Intensity	CIE
C	AA	KK

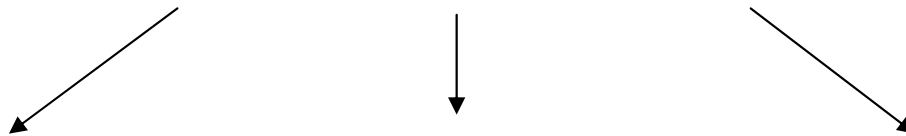

Forward Voltage (V) @ $I_F = 20\text{mA}$		
Bin Code	Min.	Max.
D	2.7	3.0
C	3.0	3.3
B	3.3	3.7
A	3.7	4.0

Luminous Intensity (mcd) @ $I_F = 20\text{mA}$		
Bin Code	Min.	Max.
AA	1120	1400
AB	1400	1800
BA	1800	2240

Color Rank @ $I_F = 20\text{mA}$	
FK	FL
GK	GL
HK	HL
IK	IL
JK	JL
KK	KL
LK	LL
MK	ML
NK	NL
OK	OL
PK	PL
QK	QL

Available ranks

[Note] All measurements were made under the standardized environment of SSC.

2) CIE Chromaticity Diagram

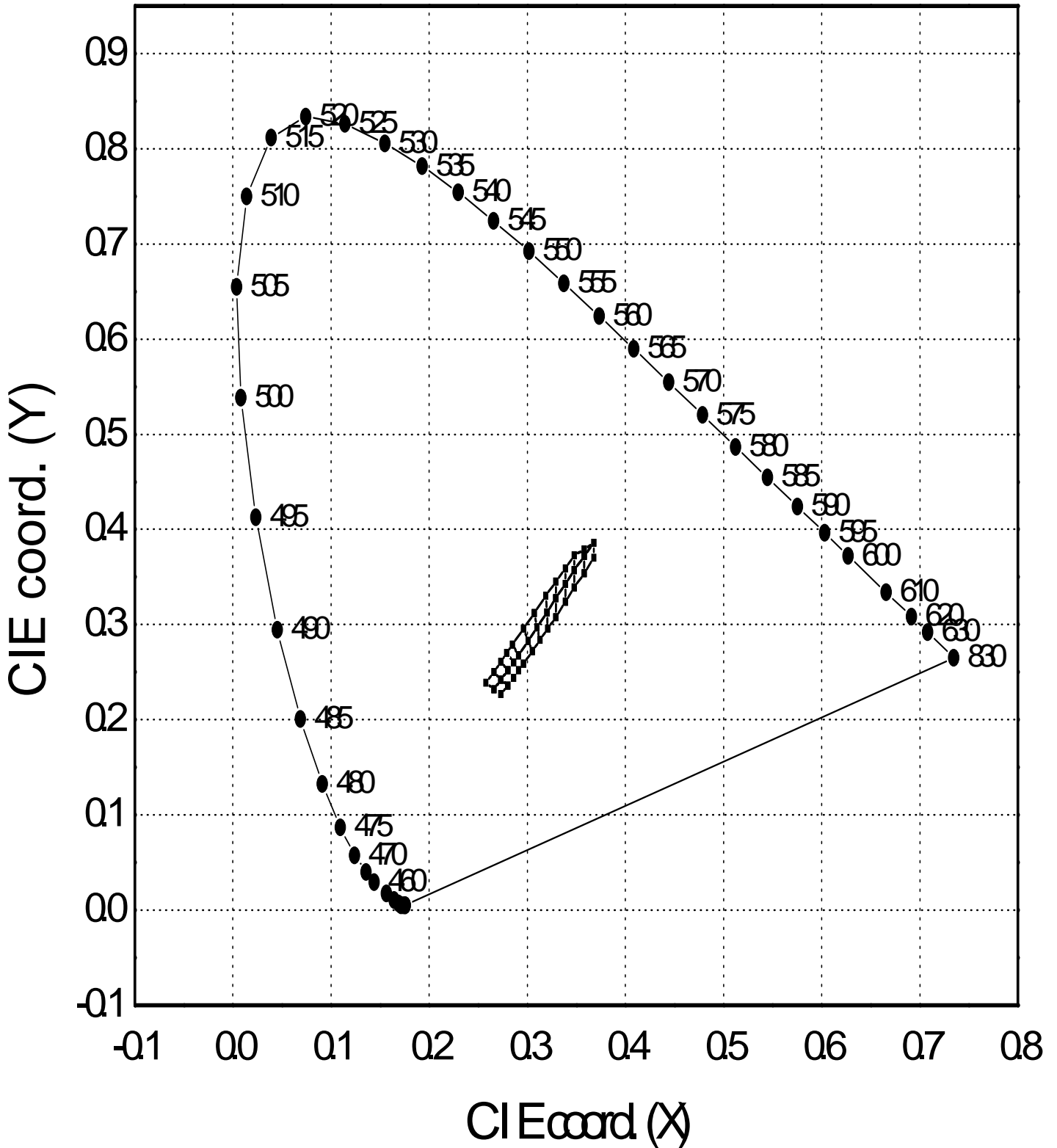

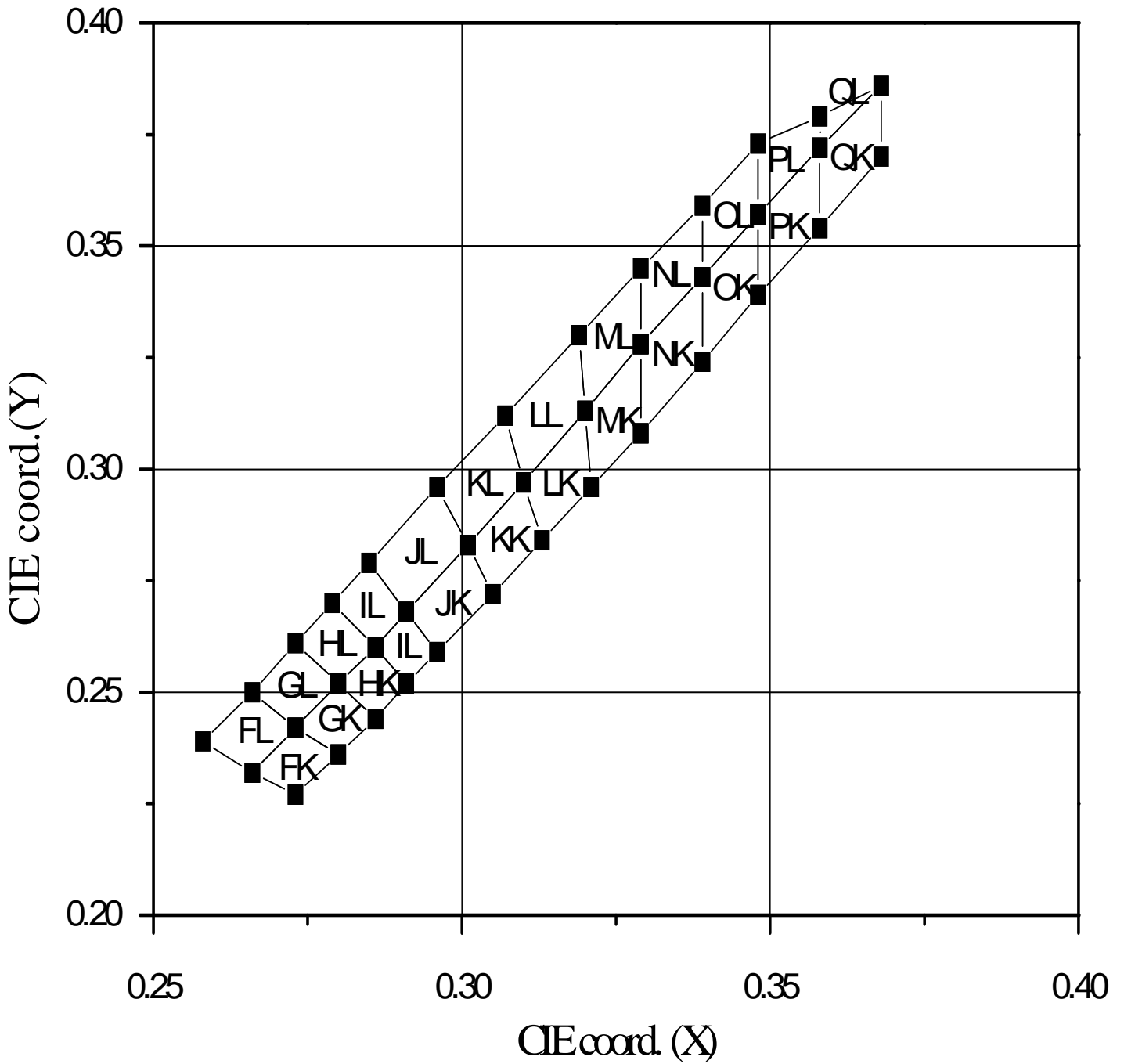

● COLOR RANK

<IF=20mA, Ta=25℃>

FK		FL		GK		GL	
CIE X	CIE Y	CIE X	CIE Y	CIE X	CIE Y	CIE X	CIE Y
0.2730	0.2270	0.2660	0.2320	0.2800	0.2360	0.2730	0.2420
0.2660	0.2320	0.2580	0.2390	0.2730	0.2420	0.2660	0.2500
0.2730	0.2420	0.2660	0.2500	0.2800	0.2520	0.2730	0.2610
0.2800	0.2360	0.2730	0.2420	0.2860	0.2440	0.2800	0.2520
HK		HL		IK		IL	
CIE X	CIE Y	CIE X	CIE Y	CIE X	CIE Y	CIE X	CIE Y
0.2860	0.2440	0.2800	0.2520	0.2910	0.2520	0.2860	0.2600
0.2800	0.2520	0.2730	0.2610	0.2860	0.2600	0.2790	0.2700
0.2860	0.2600	0.2790	0.2700	0.2910	0.2680	0.2850	0.2790
0.2910	0.2520	0.2860	0.2600	0.2960	0.2590	0.2910	0.2680
JK		JL		KK		KL	
CIE X	CIE Y	CIE X	CIE Y	CIE X	CIE Y	CIE X	CIE Y
0.2960	0.2590	0.2910	0.2680	0.3050	0.2720	0.3010	0.2830
0.2910	0.2680	0.2850	0.2790	0.3010	0.2830	0.2960	0.2960
0.3010	0.2830	0.2960	0.2960	0.3100	0.2970	0.3070	0.3120
0.3050	0.2720	0.3010	0.2830	0.3130	0.2840	0.3100	0.2970
LK		LL		MK		ML	
CIE X	CIE Y	CIE X	CIE Y	CIE X	CIE Y	CIE X	CIE Y
0.3100	0.2970	0.3070	0.3120	0.3200	0.3130	0.3190	0.3300
0.3200	0.3130	0.3190	0.3300	0.3290	0.3280	0.3290	0.3450
0.3210	0.2960	0.3200	0.3130	0.3290	0.3080	0.3290	0.3280
0.3130	0.2840	0.3100	0.2970	0.3210	0.2960	0.3200	0.3130
NK		NL		OK		OL	
CIE X	CIE Y	CIE X	CIE Y	CIE X	CIE Y	CIE X	CIE Y
0.3290	0.3080	0.3290	0.3280	0.3390	0.3240	0.3390	0.3430
0.3290	0.3280	0.3290	0.3450	0.3390	0.3430	0.3390	0.3590
0.3390	0.3430	0.3390	0.3590	0.3480	0.3570	0.3480	0.3730
0.3390	0.3240	0.3390	0.3430	0.3480	0.3390	0.3480	0.3570
PK		PL		QK		QL	
CIE X	CIE Y	CIE X	CIE Y	CIE X	CIE Y	CIE X	CIE Y
0.3480	0.3390	0.3480	0.3570	0.3580	0.3540	0.3580	0.3720
0.3480	0.3570	0.3480	0.3730	0.3580	0.3720	0.3580	0.3790
0.3580	0.3720	0.3580	0.3790	0.3680	0.3860	0.3680	0.3860
0.3580	0.3540	0.3580	0.3720	0.3680	0.3700	0.3680	0.3860

□ Available ranks

* Measurement Uncertainty of the Color Coordinates : ± 0.005

7. Package Dimension

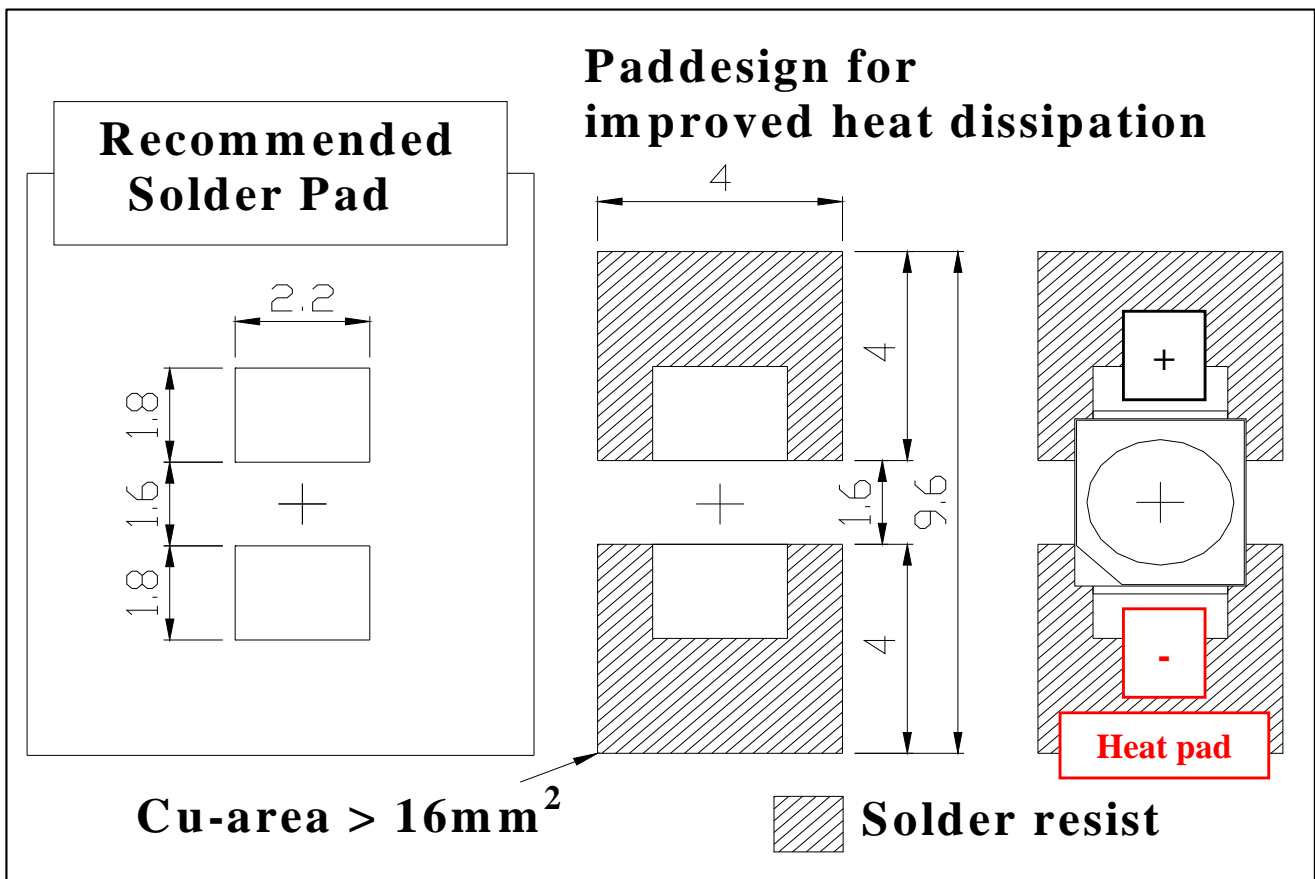
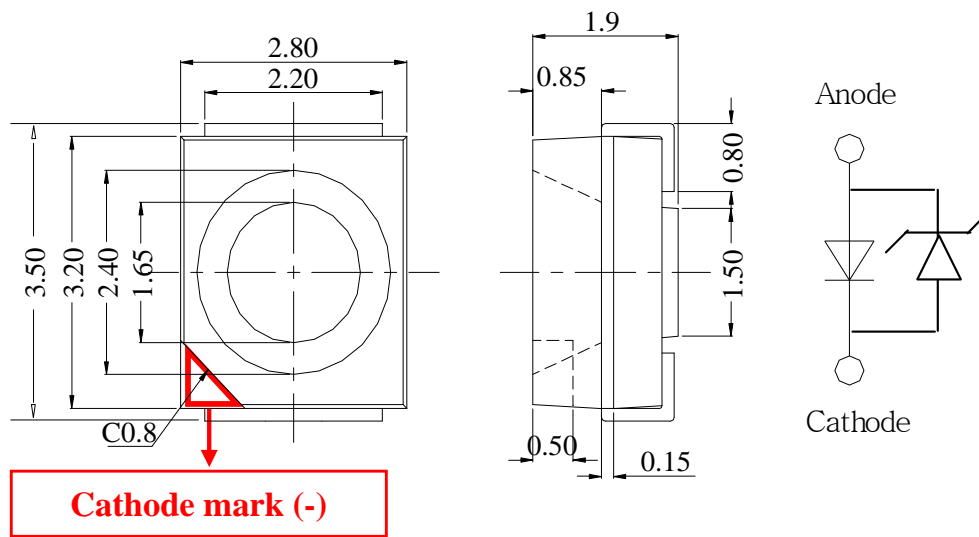

8. Material

item	Chip	Package	Encapsulate	Electrodes
Material	InGaN	Heat-Resistant Polymer	Silicone Resin + Phosphor	Ag Plating Copper Alloy

9. Packing

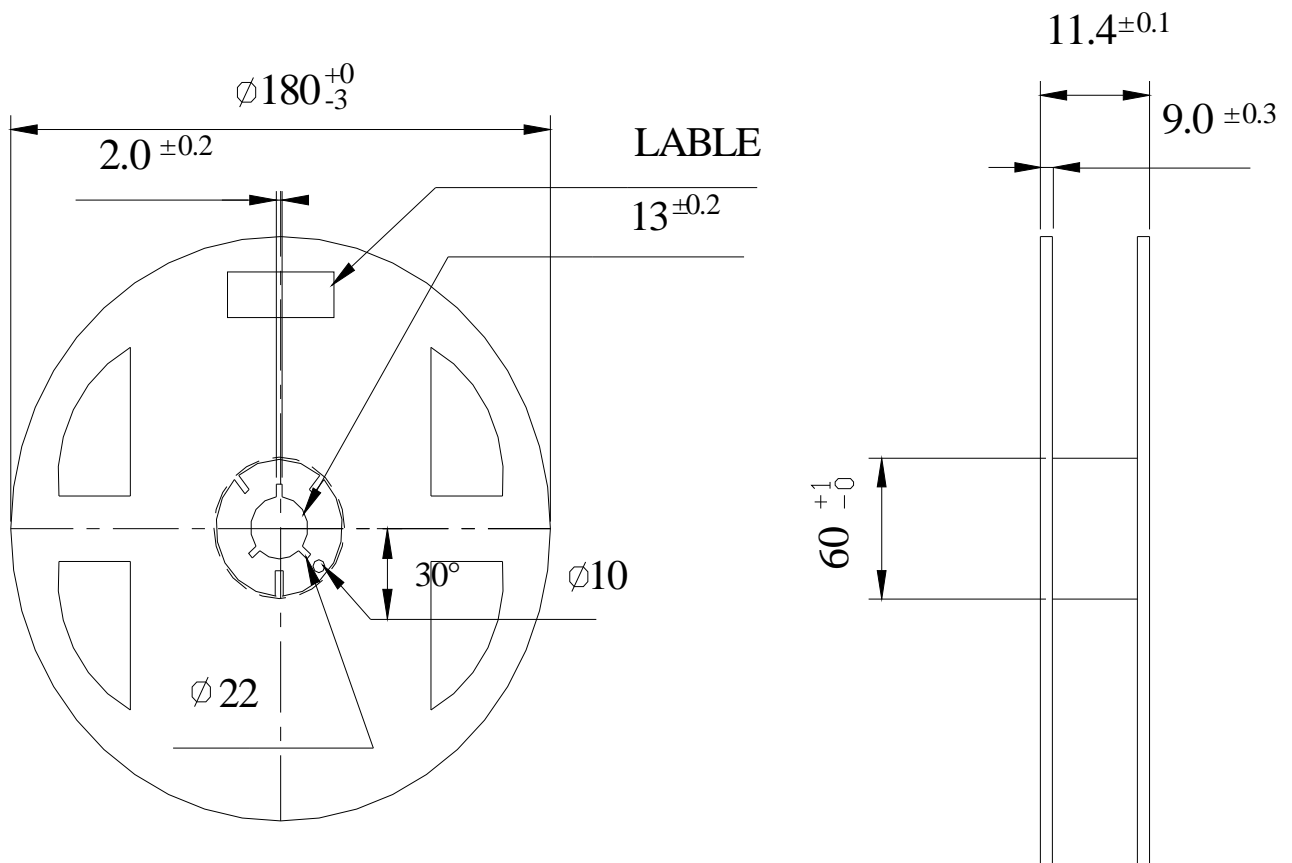
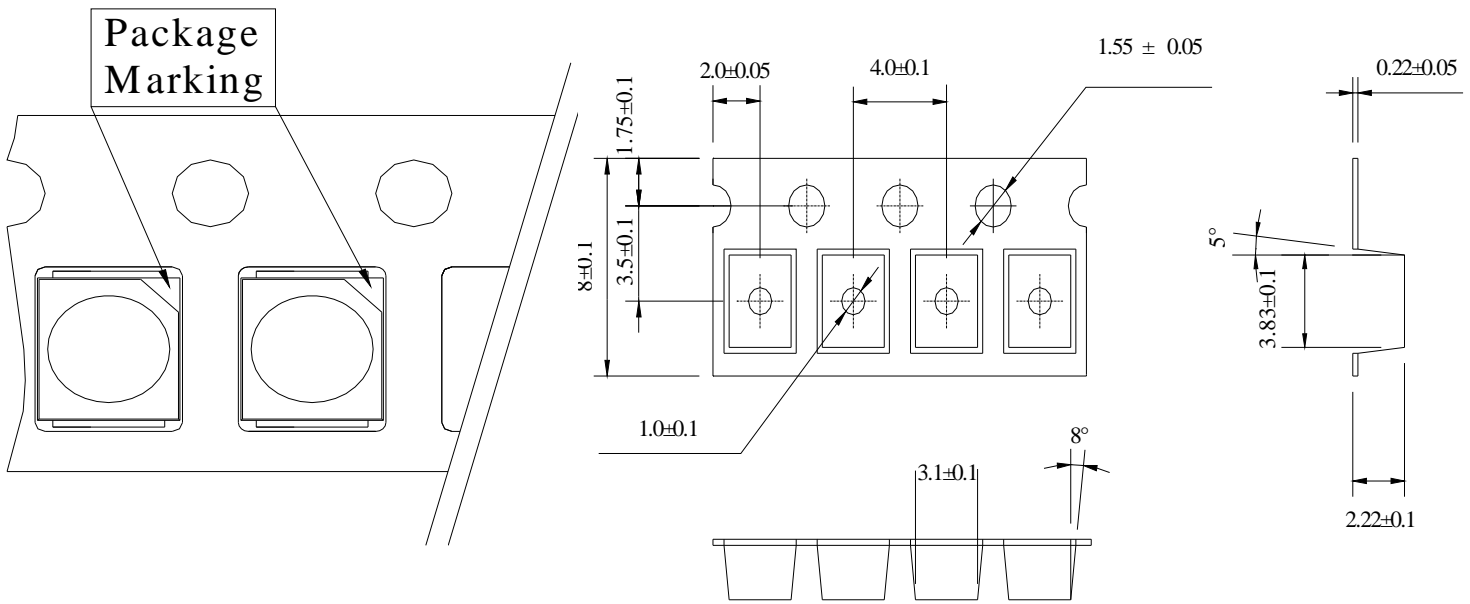

(Tolerance: ± 0.2 , Unit: mm)

- (1) Quantity : 2000pcs/Reel
- (2) Cumulative Tolerance : Cumulative Tolerance/10 pitches to be ± 0.2 mm
- (3) Adhesion Strength of Cover Tape : Adhesion strength to be 0.1-0.7N when the cover tape is turned off from the carrier tape at the angle of 10° to the carrier tape
- (4) Package : P/N, Manufacturing data Code No. and quantity to be indicated on a damp proof Package

● Reel Packing Structure

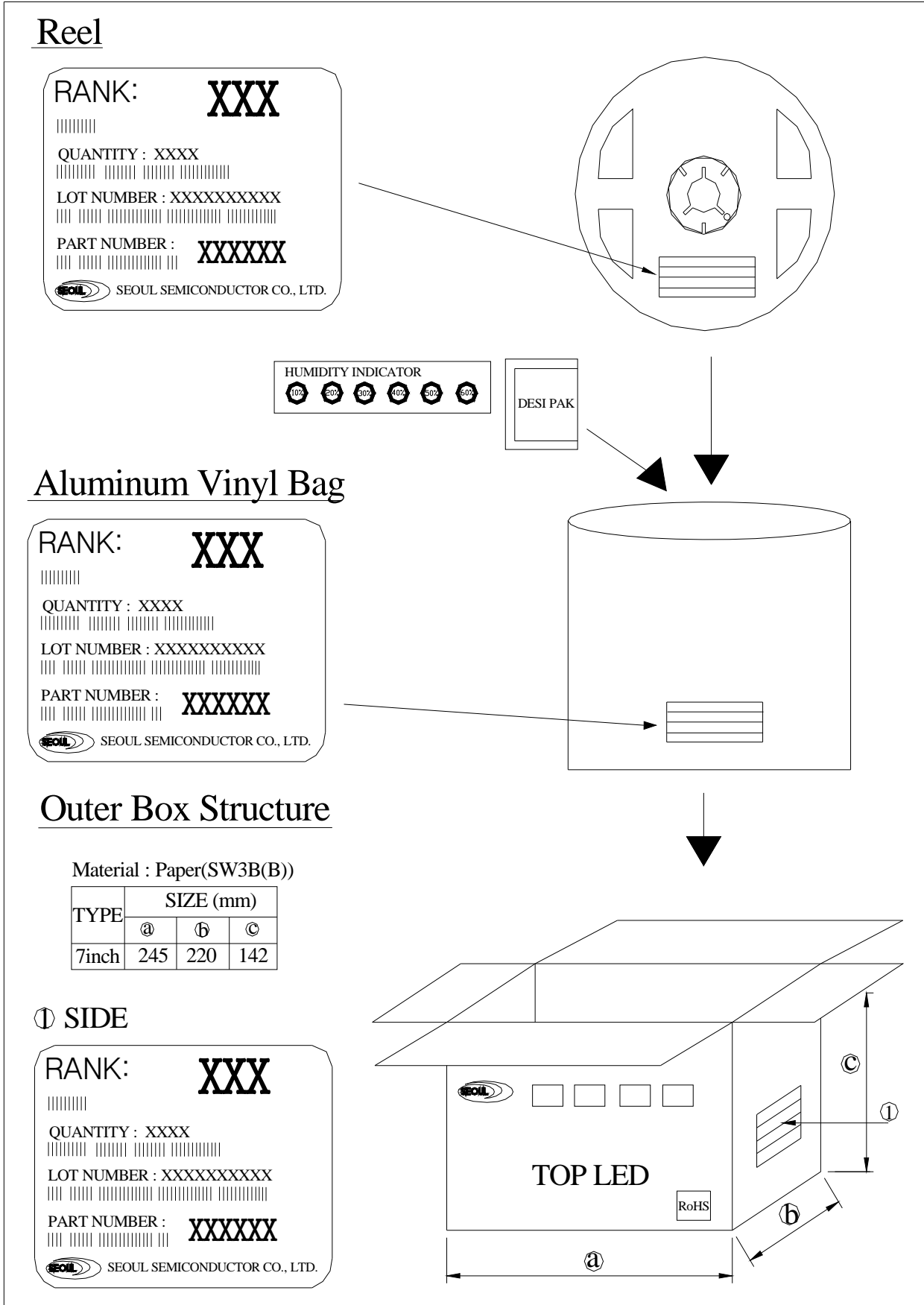

10. Soldering

(1) Lead Solder

Lead Solder	
Pre-heat	120 ~ 150°C
Pre-heat time	120 sec. Max.
Peak-Temperature	240°C Max.
Soldering time Condition	10 sec. Max.

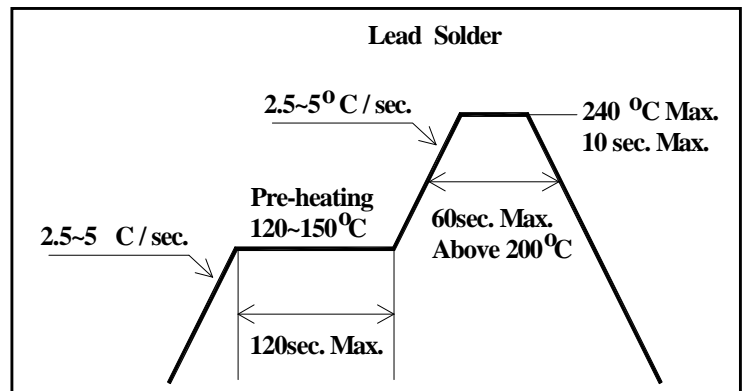

(2) Lead-Free Solder

Lead Free Solder	
Pre-heat	150 ~ 200°C
Pre-heat time	120 sec. Max.
Peak-Temperature	260°C Max.
Soldering time Condition	10 sec. Max.

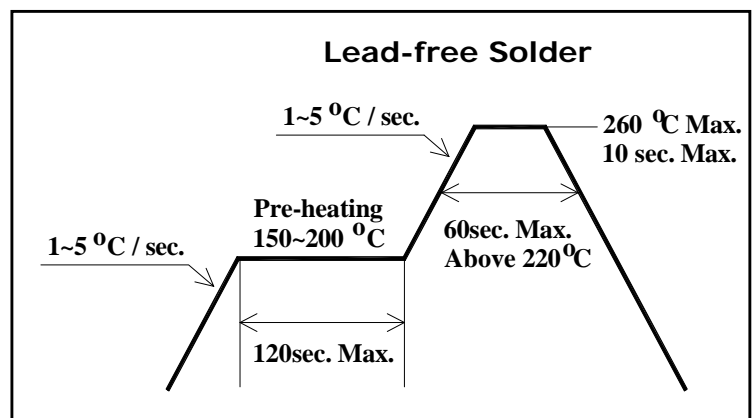

(3) Hand Soldering conditions

Do not exceed 4 seconds at maximum 315°C under soldering iron.

(4) The encapsulated material of the LEDs is silicone.

Precautions should be taken to avoid the strong pressure on the encapsulated part. So when using the chip mounter, the picking up nozzle that does not affect the silicone resin should be used.

(5) It is recommended that the customer use the nitrogen reflow method.

(6) Repairing should not be done after the LEDs have been soldered.

(7) Reflow soldering should not be done more than two times.

In the case of more than 24 hours passed soldering after first, LEDs will be damaged.

Note : In case that the soldered products are reused in soldering process, we don't guarantee the products.

11. Precaution for use

(1) Storage

In order to avoid the absorption of moisture, it is recommended to store in a dry box (or a desiccator) with a desiccant. Otherwise, to store them in the following environment is recommended.

Temperature : 5°C ~30°C Humidity : maximum 70%RH

(2) Attention after open.

LED is correspond to SMD, when LED be soldered dip, interfacial separation may affect the light transmission efficiency, causing the light intensity to drop.

Attention in followed; Keeping of a fraction

Temperature : 5 ~ 40°C Humidity : less than 30%

- (3) In the case of more than 4 week passed after opening or change color of indicator on desiccant, components shall be dried 10-12hr. at $60\pm 5^{\circ}\text{C}$.
- (4) Silver plating might be tarnished in the environment that contains corrosive gases and materials. Also any product that has tarnished lead might be decreased the solder-ability and optical-electrical properties compare to normal ones.
Please do not expose the product in the corrosive environment during the storage.
- (5) Any mechanical force or any excess vibration shall not be accepted to apply during cooling process to normal temperature after soldering.
- (6) Quick cooling shall be avoided.
- (7) Components shall not be mounted on warped direction of PCB.
- (8) Anti radioactive ray design is not considered for the products.
- (9) This device should not be used in any type of fluid such as water, oil, organic solvent etc. When washing is required, IPA should be used.
- (10) When the LEDs are illuminating, operating current should be decided after considering the ambient maximum temperature.
- (11) The LEDs must be soldered within 4 week after opening the moisture-proof packing.
- (12) Repack unused products with anti-moisture packing, fold to close any opening and then store in a dry place.
- (13) The appearance and specifications of the product may be modified for improvement without notice.

12. Handling of Silicone Resin LEDs

(1) During processing, mechanical stress on the surface should be minimized as much as possible. Sharp objects of all types should not be used to pierce the sealing compound.



(2) In general, LEDs should only be handled from the side. By the way, this also applies to LEDs without a silicone sealant, since the surface can also become scratched.

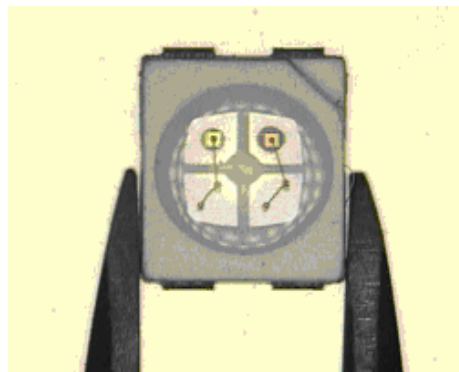

(3) When populating boards in SMT production, there are basically no restrictions regarding the form of the pick and place nozzle, except that mechanical pressure on the surface of the resin must be prevented.

This is assured by choosing a pick and place nozzle which is larger than the LED's reflector area.

(4) Silicone differs from materials conventionally used for the manufacturing of LEDs. These conditions must be considered during the handling of such devices. Compared to standard encapsulants, silicone is generally softer, and the surface is more likely to attract dust.

As mentioned previously, the increased sensitivity to dust requires special care during processing. In cases where a minimal level of dirt and dust particles cannot be guaranteed, a suitable cleaning solution must be applied to the surface after the soldering of components.

(5) SSC suggests using isopropyl alcohol for cleaning. In case other solvents are used, it must be assured that these solvents do not dissolve the package or resin.

Ultrasonic cleaning is not recommended. Ultrasonic cleaning may cause damage to the LED.

13. Revision History

Revision No	Date of Change	Page	Summary
00	July. 19 2010		The institution of New Spec.
01	January. 21 2011	4,5,6,7,8	Update Characteristics
02	May. 18 2011	4,5,6,7,8,9	Update Characteristics & Diagram
03	November. 04 2011	4,7	Update Duty characteristics
04	November. 29 2011	11,12,13, 14,19	Update bin code, CIE Chromaticity Diagram and precaution for use