



# PBSS5330PA

30 V, 3 A PNP low V<sub>CEsat</sub> (BISS) transistor

7 April 2015

Product data sheet

## 1. General description

PNP low V<sub>CEsat</sub> Breakthrough In Small Signal (BISS) transistor, encapsulated in an ultra thin SOT1061 leadless small Surface-Mounted Device (SMD) plastic package with medium power capability.

NPN complement: PBSS4330PA.

## 2. Features and benefits

- Low collector-emitter saturation voltage V<sub>CEsat</sub>
- High collector current capability I<sub>C</sub> and I<sub>CM</sub>
- Smaller required Printed-Circuit Board (PCB) area than for conventional transistors
- Exposed heat sink for excellent thermal and electrical conductivity
- Leadless small SMD plastic package with medium power capability

## 3. Applications

- Loadswitch
- Battery-driven devices
- Power management
- Charging circuits
- Power switches (e.g. motors, fans)

## 4. Quick reference data

Table 1. Quick reference data

Symbol	Parameter	Conditions	Min	Typ	Max	Unit
V <sub>CEO</sub>	collector-emitter voltage	open base	-	-	-30	V
I <sub>C</sub>	collector current		-	-	-3	A
I <sub>CM</sub>	peak collector current	single pulse; t <sub>p</sub> ≤ 1 ms	-	-	-5	A
R <sub>CEsat</sub>	collector-emitter saturation resistance	I <sub>C</sub> = -3 A; I <sub>B</sub> = -300 mA; pulsed; t <sub>p</sub> ≤ 300 μs; δ ≤ 0.02 ; T <sub>amb</sub> = 25 °C	-	75	107	mΩ

## 5. Pinning information

Table 2. Pinning information

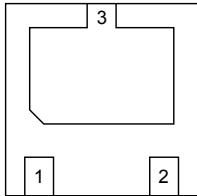
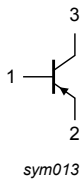
Pin	Symbol	Description	Simplified outline	Graphic symbol
1	B	base	 <p>Transparent top view</p> <p><b>DFN2020-3 (SOT1061)</b></p>	 <p>sym013</p>
2	E	emitter		
3	C	collector		

## 6. Ordering information

Table 3. Ordering information

Type number	Package		
	Name	Description	Version
PBSS5330PA	DFN2020-3	DFN2020-3: plastic thermal enhanced ultra thin small outline package; no leads; 3 terminals; body 2 x 2 x 0.65 mm	SOT1061

## 7. Marking

Table 4. Marking codes

Type number	Marking code
PBSS5330PA	AJ

## 8. Limiting values

**Table 5. Limiting values**

In accordance with the Absolute Maximum Rating System (IEC 60134).

Symbol	Parameter	Conditions		Min	Max	Unit
V <sub>CBO</sub>	collector-base voltage	open emitter		-	-30	V
V <sub>CEO</sub>	collector-emitter voltage	open base		-	-30	V
V <sub>EBO</sub>	emitter-base voltage	open collector		-	-6	V
I <sub>C</sub>	collector current			-	-3	A
I <sub>CM</sub>	peak collector current	single pulse; t <sub>p</sub> ≤ 1 ms		-	-5	A
I <sub>B</sub>	base current			-	-500	mA
P <sub>tot</sub>	total power dissipation	T <sub>amb</sub> ≤ 25 °C	[1]	-	500	mW
			[2]	-	1	W
			[3]	-	1.25	W
			[4]	-	2.1	W
T <sub>j</sub>	junction temperature			-	150	°C
T <sub>amb</sub>	ambient temperature			-55	150	°C
T <sub>stg</sub>	storage temperature			-65	150	°C

- [1] Device mounted on an FR4 PCB, single-sided copper, tin-plated and standard footprint.
- [2] Device mounted on an FR4 PCB, single-sided copper, tin-plated, mounting pad for collector 1 cm<sup>2</sup>.
- [3] Device mounted on an FR4 PCB, single-sided copper, tin-plated, mounting pad for collector 6 cm<sup>2</sup>.
- [4] Device mounted on a ceramic PCB, Al<sub>2</sub>O<sub>3</sub>, standard footprint.

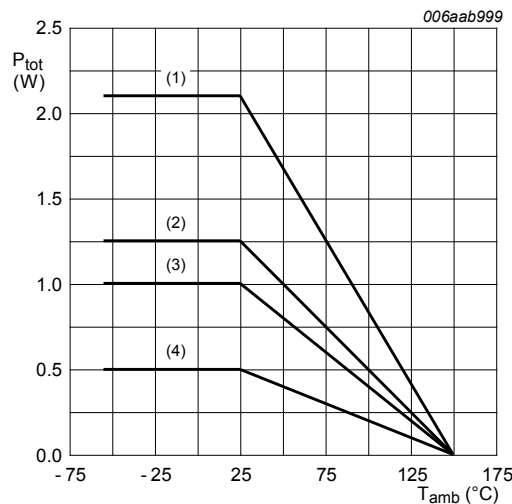

- (1) Ceramic PCB, Al<sub>2</sub>O<sub>3</sub>, standard footprint
- (2) FR4 PCB, mounting pad for collector 6 cm<sup>2</sup>
- (3) FR4 PCB, mounting pad for collector 1 cm<sup>2</sup>
- (4) FR4 PCB, standard footprint

**Fig. 1. Power derating curves**

## 9. Thermal characteristics

Table 6. Thermal characteristics

Symbol	Parameter	Conditions		Min	Typ	Max	Unit
$R_{th(j-a)}$	thermal resistance from junction to ambient	in free air	[1]	-	-	250	K/W
			[2]	-	-	125	K/W
			[3]	-	-	100	K/W
			[4]	-	-	60	K/W

- [1] Device mounted on an FR4 PCB, single-sided copper, tin-plated and standard footprint.
- [2] Device mounted on an FR4 PCB, single-sided copper, tin-plated, mounting pad for collector 1 cm<sup>2</sup>.
- [3] Device mounted on an FR4 PCB, single-sided copper, tin-plated, mounting pad for collector 6 cm<sup>2</sup>.
- [4] Device mounted on a ceramic PCB, Al<sub>2</sub>O<sub>3</sub>, standard footprint.

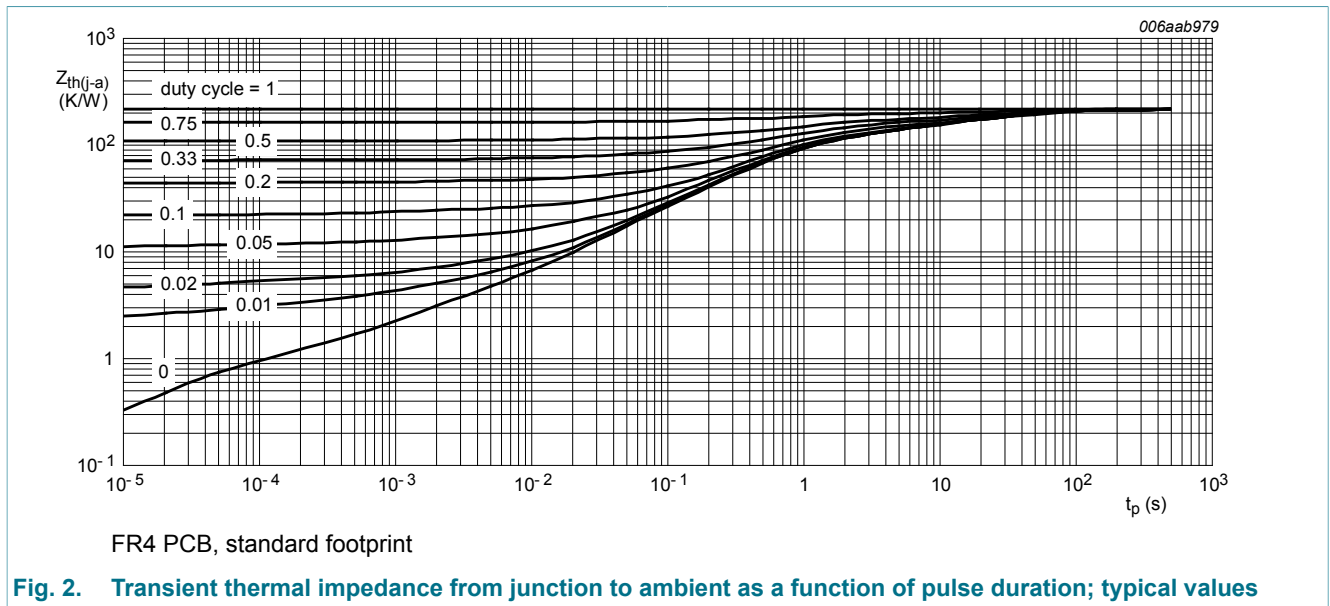
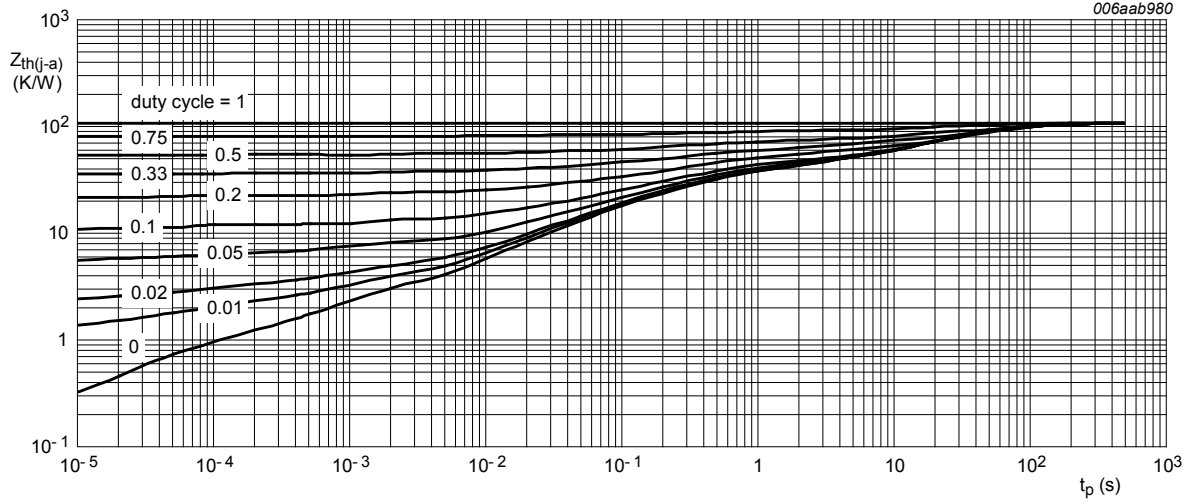
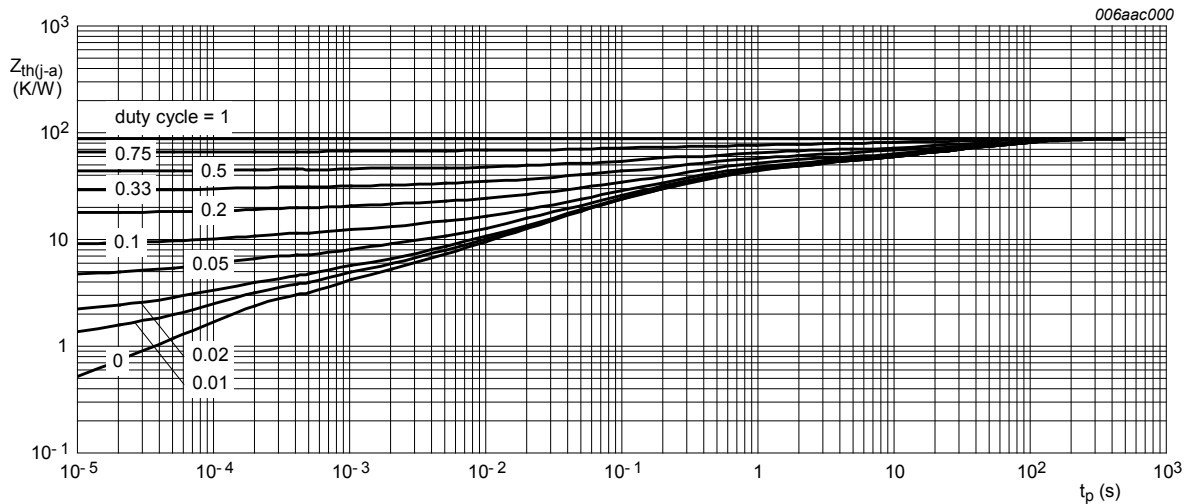

Fig. 2. Transient thermal impedance from junction to ambient as a function of pulse duration; typical values



FR4 PCB, mounting pad for collector 1 cm<sup>2</sup>

Fig. 3. Transient thermal impedance from junction to ambient as a function of pulse duration; typical values



FR4 PCB, mounting pad for collector 6 cm<sup>2</sup>

Fig. 4. Transient thermal impedance from junction to ambient as a function of pulse duration; typical values

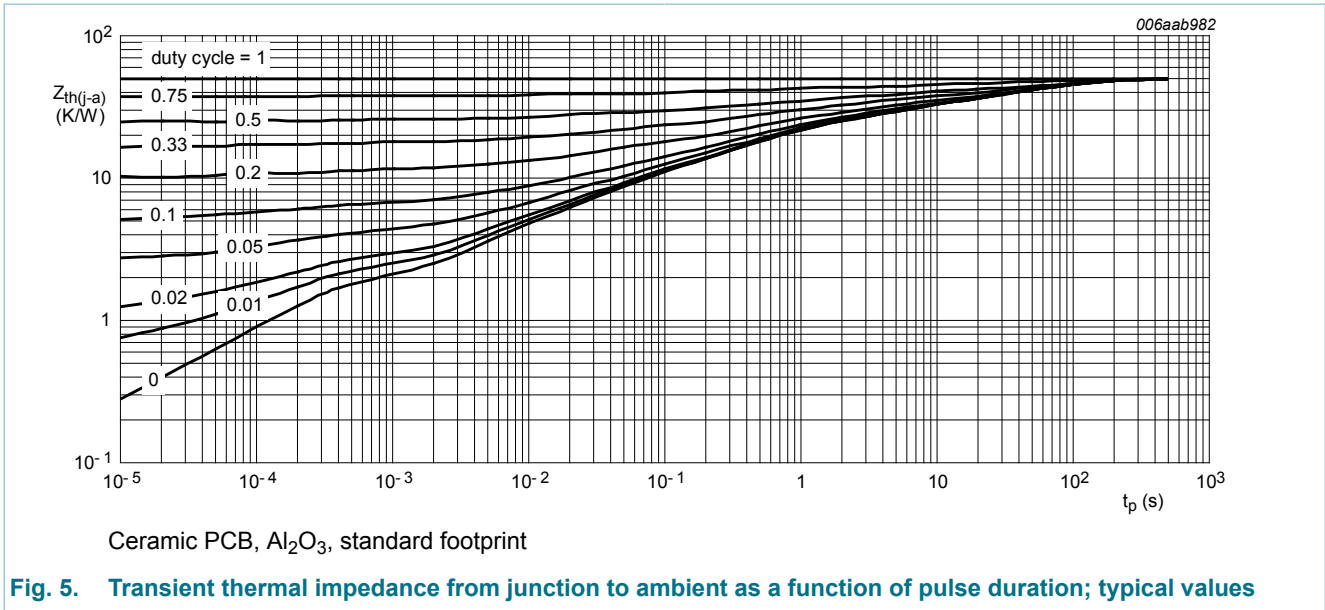

Fig. 5. Transient thermal impedance from junction to ambient as a function of pulse duration; typical values

## 10. Characteristics

Table 7. Characteristics

Symbol	Parameter	Conditions	Min	Typ	Max	Unit
I <sub>CBO</sub>	collector-base cut-off current	V <sub>CB</sub> = -30 V; I <sub>E</sub> = 0 A; T <sub>amb</sub> = 25 °C	-	-	-100	nA
		V <sub>CB</sub> = -30 V; I <sub>E</sub> = 0 A; T <sub>j</sub> = 150 °C	-	-	-50	μA
I <sub>CES</sub>	collector-emitter cut-off current	V <sub>CE</sub> = -24 V; V <sub>BE</sub> = 0 V; T <sub>amb</sub> = 25 °C	-	-	-100	nA
I <sub>EBO</sub>	emitter-base cut-off current	V <sub>EB</sub> = -5 V; I <sub>C</sub> = 0 A; T <sub>amb</sub> = 25 °C	-	-	-100	nA
h <sub>FE</sub>	DC current gain	V <sub>CE</sub> = -2 V; I <sub>C</sub> = -0.5 A; pulsed; t <sub>p</sub> ≤ 300 μs; δ ≤ 0.02 ; T <sub>amb</sub> = 25 °C	200	320	-	
		V <sub>CE</sub> = -2 V; I <sub>C</sub> = -1 A; pulsed; t <sub>p</sub> ≤ 300 μs; δ ≤ 0.02 ; T <sub>amb</sub> = 25 °C	175	280	450	
		V <sub>CE</sub> = -2 V; I <sub>C</sub> = -2 A; pulsed; t <sub>p</sub> ≤ 300 μs; δ ≤ 0.02 ; T <sub>amb</sub> = 25 °C	140	210	-	
		V <sub>CE</sub> = -2 V; I <sub>C</sub> = -3 A; pulsed; t <sub>p</sub> ≤ 300 μs; δ ≤ 0.02 ; T <sub>amb</sub> = 25 °C	100	160	-	
V <sub>CEsat</sub>	collector-emitter saturation voltage	I <sub>C</sub> = -0.5 A; I <sub>B</sub> = -50 mA; pulsed; t <sub>p</sub> ≤ 300 μs; δ ≤ 0.02 ; T <sub>amb</sub> = 25 °C	-	-45	-70	mV
		I <sub>C</sub> = -1 A; I <sub>B</sub> = -50 mA; pulsed; t <sub>p</sub> ≤ 300 μs; δ ≤ 0.02 ; T <sub>amb</sub> = 25 °C	-	-90	-130	mV
		I <sub>C</sub> = -2 A; I <sub>B</sub> = -100 mA; pulsed; t <sub>p</sub> ≤ 300 μs; δ ≤ 0.02 ; T <sub>amb</sub> = 25 °C	-	-170	-240	mV
		I <sub>C</sub> = -3 A; I <sub>B</sub> = -300 mA; pulsed; t <sub>p</sub> ≤ 300 μs; δ ≤ 0.02 ; T <sub>amb</sub> = 25 °C	-	-230	-320	mV
R <sub>CEsat</sub>	collector-emitter saturation resistance	t <sub>p</sub> ≤ 300 μs; δ ≤ 0.02 ; T <sub>amb</sub> = 25 °C	-	75	107	mΩ
V <sub>BEsat</sub>	base-emitter saturation voltage	I <sub>C</sub> = -2 A; I <sub>B</sub> = -100 mA; pulsed; t <sub>p</sub> ≤ 300 μs; δ ≤ 0.02 ; T <sub>amb</sub> = 25 °C	-	-0.89	-1.1	V
		I <sub>C</sub> = -3 A; I <sub>B</sub> = -300 mA; pulsed; t <sub>p</sub> ≤ 300 μs; δ ≤ 0.02 ; T <sub>amb</sub> = 25 °C	-	-0.97	-1.2	V
V <sub>BEon</sub>	base-emitter turn-on voltage	V <sub>CE</sub> = -2 V; I <sub>C</sub> = -1 A; pulsed; t <sub>p</sub> ≤ 300 μs; δ ≤ 0.02 ; T <sub>amb</sub> = 25 °C	-	-0.75	-1	V
t <sub>d</sub>	delay time	V <sub>CC</sub> = -9 V; I <sub>C</sub> = -2 A; I <sub>Bon</sub> = -0.1 A; I <sub>Boff</sub> = 0.1 A; T <sub>amb</sub> = 25 °C	-	11	-	ns
t <sub>r</sub>	rise time		-	59	-	ns
t <sub>on</sub>	turn-on time		-	70	-	ns
t <sub>s</sub>	storage time		-	165	-	ns
t <sub>f</sub>	fall time		-	35	-	ns
t <sub>off</sub>	turn-off time		-	200	-	ns

Symbol	Parameter	Conditions	Min	Typ	Max	Unit
$f_T$	transition frequency	$V_{CE} = -5\text{ V}$ ; $I_C = -100\text{ mA}$ ; $f = 100\text{ MHz}$ ; $T_{amb} = 25\text{ }^\circ\text{C}$	100	165	-	MHz
$C_c$	collector capacitance	$V_{CB} = -10\text{ V}$ ; $I_E = 0\text{ A}$ ; $i_e = 0\text{ A}$ ; $f = 1\text{ MHz}$ ; $T_{amb} = 25\text{ }^\circ\text{C}$	-	38	45	pF

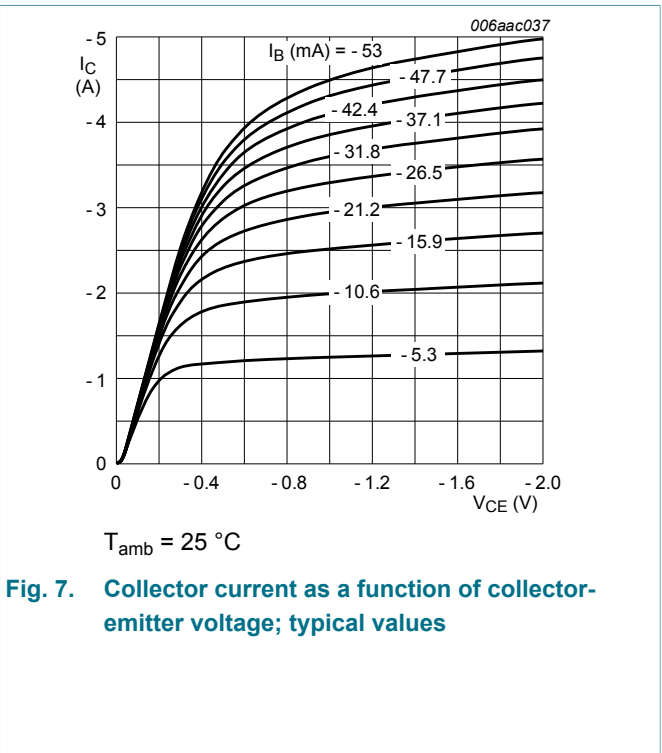
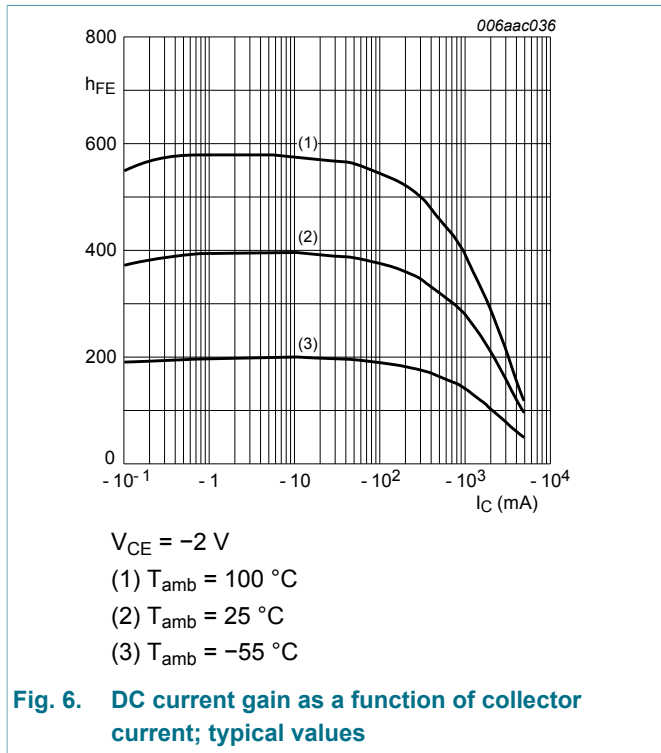



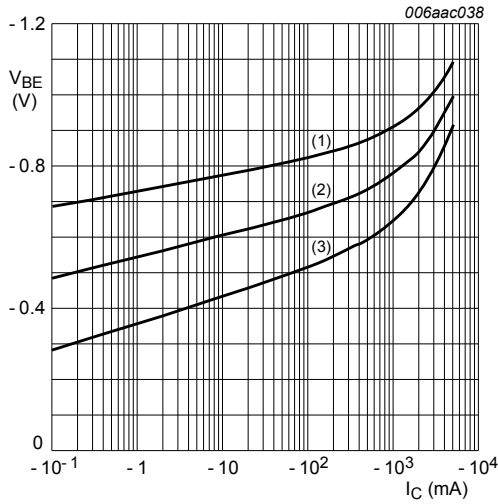

$V_{CE} = -2\text{ V}$   
 (1)  $T_{amb} = -55\text{ }^{\circ}\text{C}$   
 (2)  $T_{amb} = 25\text{ }^{\circ}\text{C}$   
 (3)  $T_{amb} = 100\text{ }^{\circ}\text{C}$

**Fig. 8. Base-emitter voltage as a function of collector current; typical values**

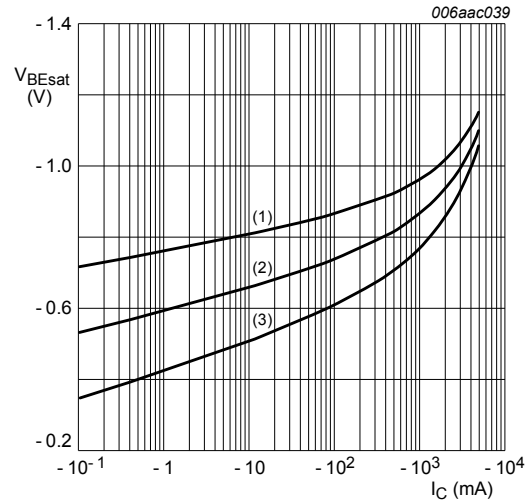

$I_C/I_B = 20$   
 (1)  $T_{amb} = -55\text{ }^{\circ}\text{C}$   
 (2)  $T_{amb} = 25\text{ }^{\circ}\text{C}$   
 (3)  $T_{amb} = 100\text{ }^{\circ}\text{C}$

**Fig. 9. Base-emitter saturation voltage as a function of collector current; typical values**

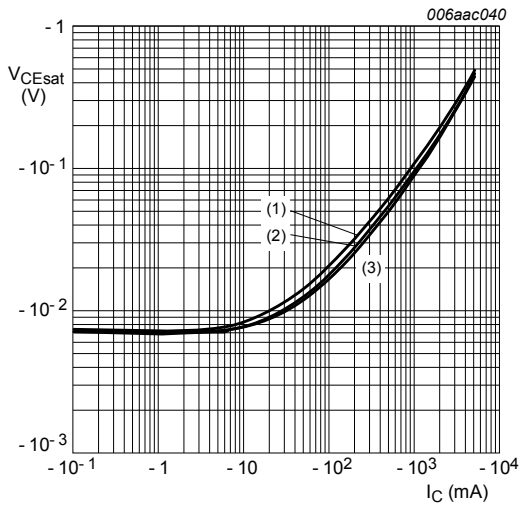

$I_C/I_B = 20$   
 (1)  $T_{amb} = 100\text{ }^{\circ}\text{C}$   
 (2)  $T_{amb} = 25\text{ }^{\circ}\text{C}$   
 (3)  $T_{amb} = -55\text{ }^{\circ}\text{C}$

**Fig. 10. Collector-emitter saturation voltage as a function of collector current; typical values**

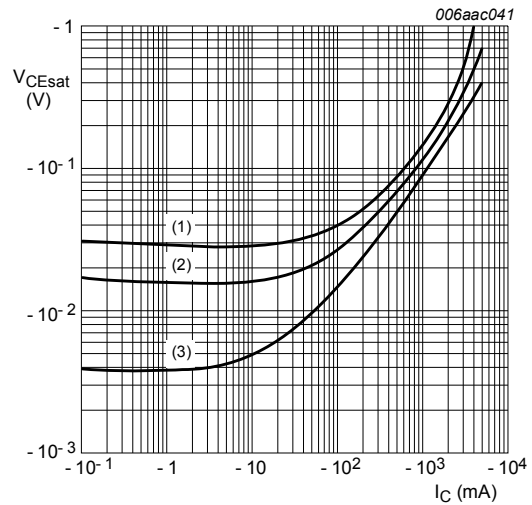

$T_{amb} = 25\text{ }^{\circ}\text{C}$   
 (1)  $I_C/I_B = 100$   
 (2)  $I_C/I_B = 50$   
 (3)  $I_C/I_B = 10$

**Fig. 11. Collector-emitter saturation voltage as a function of collector current; typical values**

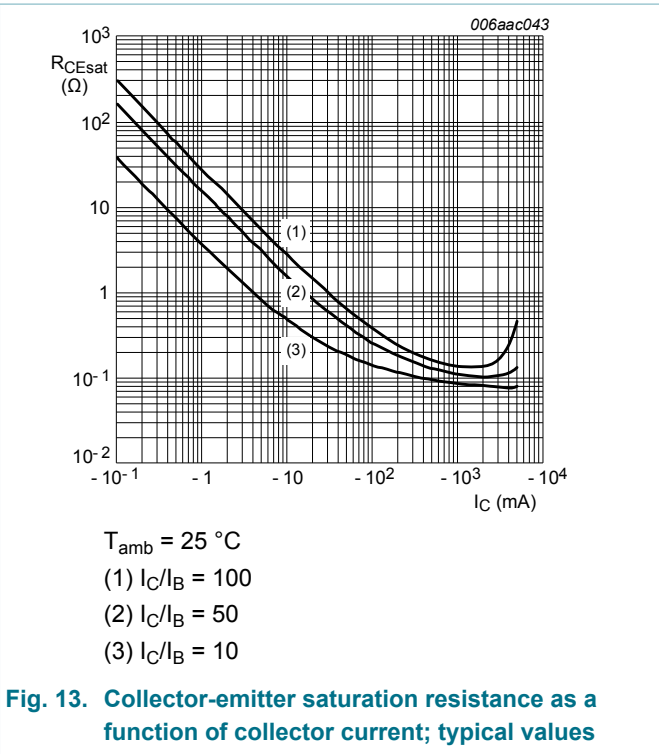
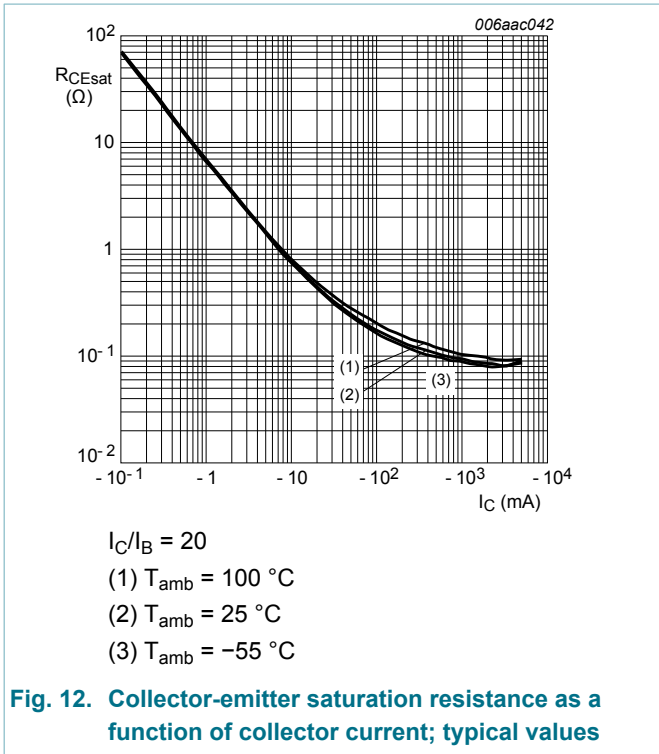

### 11. Test information

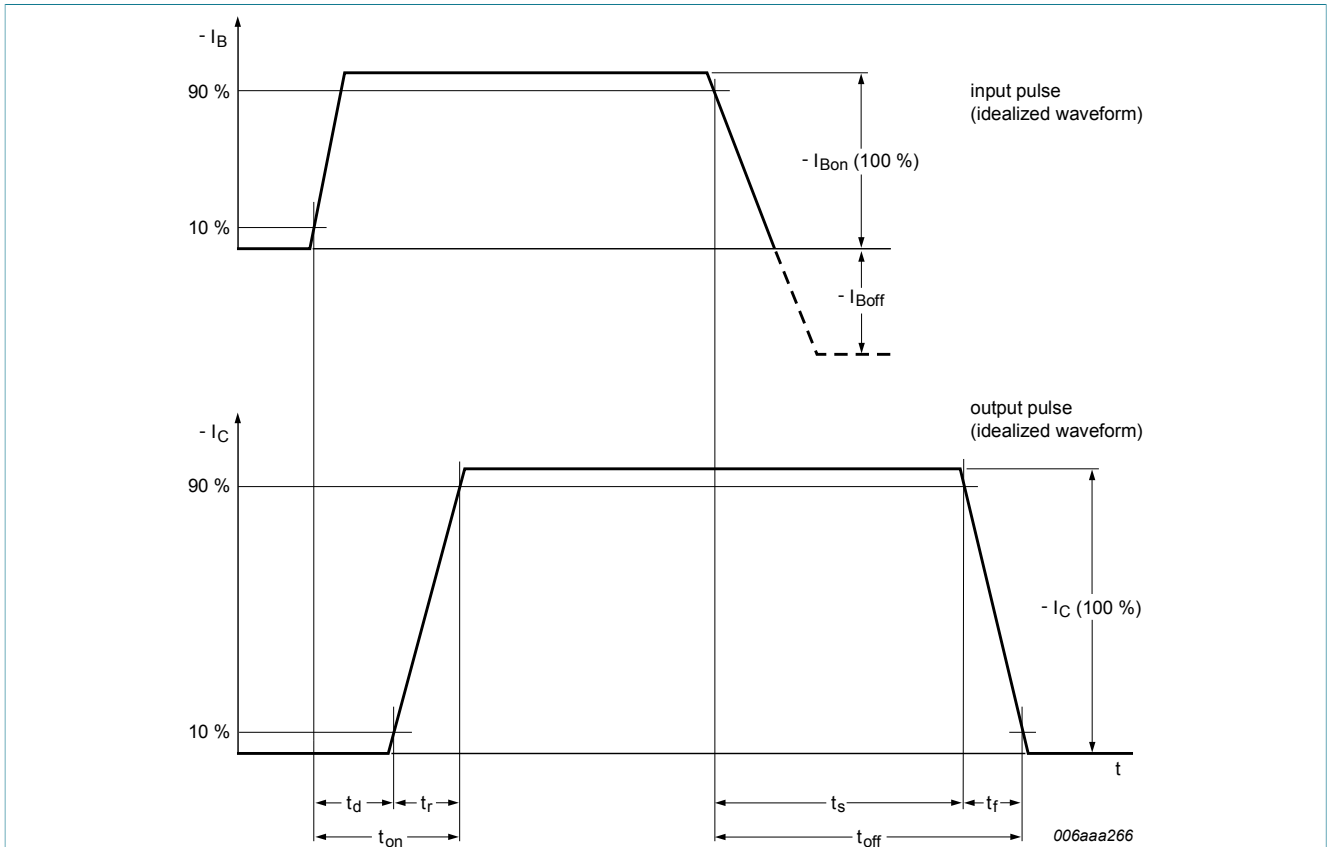

Fig. 14. BISS transistor switching time definition

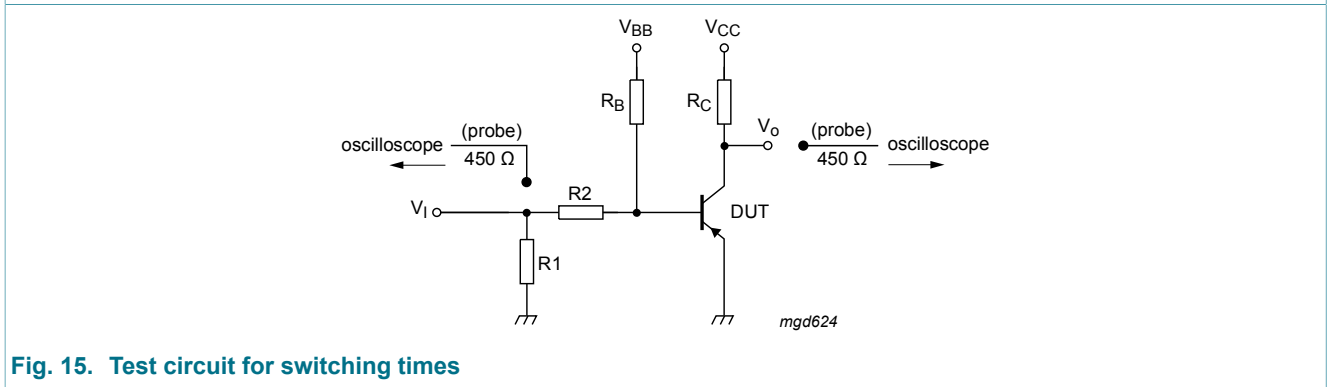

Fig. 15. Test circuit for switching times



## 14. Revision history

Table 8. Revision history

Data sheet ID	Release date	Data sheet status	Change notice	Supersedes
PBSS5330PA v.2	20150407	Product data sheet	-	PBSS5330PA v.1
Modifications:	<ul style="list-style-type: none"><li>Condition <math>V_{CE}</math> changed for parameter <math>I_{CES}</math> in Table 7, Characteristics</li></ul>			
PBSS5330PA v.1	20100419	Product data sheet	-	-

## 15. Legal information

### 15.1 Data sheet status

Document status [1][2]	Product status [3]	Definition
Objective [short] data sheet	Development	This document contains data from the objective specification for product development.
Preliminary [short] data sheet	Qualification	This document contains data from the preliminary specification.
Product [short] data sheet	Production	This document contains the product specification.

- [1] Please consult the most recently issued document before initiating or completing a design.
- [2] The term 'short data sheet' is explained in section "Definitions".
- [3] The product status of device(s) described in this document may have changed since this document was published and may differ in case of multiple devices. The latest product status information is available on the Internet at URL <http://www.nexperia.com>.

### 15.2 Definitions

**Preview** — The document is a preview version only. The document is still subject to formal approval, which may result in modifications or additions. Nexperia does not give any representations or warranties as to the accuracy or completeness of information included herein and shall have no liability for the consequences of use of such information.

**Draft** — The document is a draft version only. The content is still under internal review and subject to formal approval, which may result in modifications or additions. Nexperia does not give any representations or warranties as to the accuracy or completeness of information included herein and shall have no liability for the consequences of use of such information.

**Short data sheet** — A short data sheet is an extract from a full data sheet with the same product type number(s) and title. A short data sheet is intended for quick reference only and should not be relied upon to contain detailed and full information. For detailed and full information see the relevant full data sheet, which is available on request via the local Nexperia sales office. In case of any inconsistency or conflict with the short data sheet, the full data sheet shall prevail.

**Product specification** — The information and data provided in a Product data sheet shall define the specification of the product as agreed between Nexperia and its customer, unless Nexperia and customer have explicitly agreed otherwise in writing. In no event however, shall an agreement be valid in which the Nexperia product is deemed to offer functions and qualities beyond those described in the Product data sheet.

### 15.3 Disclaimers

**Limited warranty and liability** — Information in this document is believed to be accurate and reliable. However, Nexperia does not give any representations or warranties, expressed or implied, as to the accuracy or completeness of such information and shall have no liability for the consequences of use of such information. Nexperia takes no responsibility for the content in this document if provided by an information source outside of Nexperia.

In no event shall Nexperia be liable for any indirect, incidental, punitive, special or consequential damages (including - without limitation - lost profits, lost savings, business interruption, costs related to the removal or replacement of any products or rework charges) whether or not such damages are based on tort (including negligence), warranty, breach of contract or any other legal theory.

Notwithstanding any damages that customer might incur for any reason whatsoever, Nexperia's aggregate and cumulative liability towards customer for the products described herein shall be limited in accordance with the *Terms and conditions of commercial sale* of Nexperia.

**Right to make changes** — Nexperia reserves the right to make changes to information published in this document, including without limitation specifications and product descriptions, at any time and without notice. This document supersedes and replaces all information supplied prior to the publication hereof.

**Suitability for use** — Nexperia products are not designed, authorized or warranted to be suitable for use in life support, life-critical or safety-critical systems or equipment, nor in applications where failure or malfunction of a Nexperia product can reasonably be expected to result in personal injury, death or severe property or environmental damage. Nexperia and its suppliers accept no liability for inclusion and/or use of Nexperia products in such equipment or applications and therefore such inclusion and/or use is at the customer's own risk.

**Quick reference data** — The Quick reference data is an extract of the product data given in the Limiting values and Characteristics sections of this document, and as such is not complete, exhaustive or legally binding.

**Applications** — Applications that are described herein for any of these products are for illustrative purposes only. Nexperia makes no representation or warranty that such applications will be suitable for the specified use without further testing or modification.

Customers are responsible for the design and operation of their applications and products using Nexperia products, and Nexperia accepts no liability for any assistance with applications or customer product design. It is customer's sole responsibility to determine whether the Nexperia product is suitable and fit for the customer's applications and products planned, as well as for the planned application and use of customer's third party customer(s). Customers should provide appropriate design and operating safeguards to minimize the risks associated with their applications and products.

Nexperia does not accept any liability related to any default, damage, costs or problem which is based on any weakness or default in the customer's applications or products, or the application or use by customer's third party customer(s). Customer is responsible for doing all necessary testing for the customer's applications and products using Nexperia products in order to avoid a default of the applications and the products or of the application or use by customer's third party customer(s). Nexperia does not accept any liability in this respect.

**Limiting values** — Stress above one or more limiting values (as defined in the Absolute Maximum Ratings System of IEC 60134) will cause permanent damage to the device. Limiting values are stress ratings only and (proper) operation of the device at these or any other conditions above those given in the Recommended operating conditions section (if present) or the Characteristics sections of this document is not warranted. Constant or repeated exposure to limiting values will permanently and irreversibly affect the quality and reliability of the device.

**Terms and conditions of commercial sale** — Nexperia products are sold subject to the general terms and conditions of commercial sale, as published at <http://www.nexperia.com/profile/terms>, unless otherwise agreed in a valid written individual agreement. In case an individual agreement is concluded only the terms and conditions of the respective agreement shall apply. Nexperia hereby expressly objects to applying the customer's general terms and conditions with regard to the purchase of Nexperia products by customer.

**No offer to sell or license** — Nothing in this document may be interpreted or construed as an offer to sell products that is open for acceptance or the

grant, conveyance or implication of any license under any copyrights, patents or other industrial or intellectual property rights.

**Export control** — This document as well as the item(s) described herein may be subject to export control regulations. Export might require a prior authorization from competent authorities.

**Non-automotive qualified products** — Unless this data sheet expressly states that this specific Nexperia product is automotive qualified, the product is not suitable for automotive use. It is neither qualified nor tested in accordance with automotive testing or application requirements. Nexperia accepts no liability for inclusion and/or use of non-automotive qualified products in automotive equipment or applications.

In the event that customer uses the product for design-in and use in automotive applications to automotive specifications and standards, customer (a) shall use the product without Nexperia's warranty of the product for such automotive applications, use and specifications, and (b) whenever customer uses the product for automotive applications beyond Nexperia's specifications such use shall be solely at customer's own risk, and (c) customer fully indemnifies Nexperia for any liability, damages or failed product claims resulting from customer design and use of the product for automotive applications beyond Nexperia's standard warranty and Nexperia's product specifications.

**Translations** — A non-English (translated) version of a document is for reference only. The English version shall prevail in case of any discrepancy between the translated and English versions.

## 15.4 Trademarks

Notice: All referenced brands, product names, service names and trademarks are the property of their respective owners.

## 16. Contents

1	General description .....	1
2	Features and benefits .....	1
3	Applications .....	1
4	Quick reference data .....	1
5	Pinning information .....	2
6	Ordering information .....	2
7	Marking .....	2
8	Limiting values .....	3
9	Thermal characteristics .....	4
10	Characteristics .....	7
11	Test information .....	11
12	Package outline .....	12
13	Soldering .....	12
14	Revision history .....	13
15	Legal information .....	14
15.1	Data sheet status .....	14
15.2	Definitions .....	14
15.3	Disclaimers .....	14
15.4	Trademarks .....	15

© Nexperia B.V. 2017. All rights reserved

For more information, please visit: <http://www.nexperia.com>

For sales office addresses, please send an email to: [salesaddresses@nexperia.com](mailto:salesaddresses@nexperia.com)

Date of release: 07 April 2015