

**WyzBee™**

**User Manual**

**Version 1.2**

**October 2015**

**Redpine Signals, Inc.**

2107 N. First Street, #680

San Jose, CA95131.

Tel: (408) 748-3385

Fax: (408) 705-2019

Email: [info@redpinesignals.com](mailto:info@redpinesignals.com)

Website: [www.redpinesignals.com](http://www.redpinesignals.com)

---

**About this Document**

This document describes general information of WyzBee™ along with the board bring up and installation procedure for software tools for developing applications, including a sample TriLED demo programmed using Keil IDE platform. This document elaborates all the features and steps for using the WyzBee™ platform.

**Disclaimer:**

The information in this document pertains to information related to Redpine Signals, Inc. products. This information is provided as a service to our customers, and may be used for information purposes only. Redpine assumes no liabilities or responsibilities for errors or omissions in this document. This document may be changed at any time at Redpine's sole discretion without any prior notice to anyone. Redpine is not committed to updating this document in the future.

Copyright © 2015 Redpine Signals, Inc. All rights reserved.

## Table of Contents

<b>1</b>	<b>Introduction .....</b>	<b>5</b>
<b>1.1</b>	<b>Features.....</b>	<b>5</b>
1.1.1	MCU Features.....	5
1.1.2	WLAN Features.....	6
1.1.3	Bluetooth.....	6
1.1.4	ZigBee .....	6
1.1.5	General.....	6
<b>1.2</b>	<b>WyzBee™ Board.....</b>	<b>7</b>
<b>1.3</b>	<b>WyzBee™ Top View .....</b>	<b>8</b>
<b>1.4</b>	<b>WyzBee™ Bottom View .....</b>	<b>8</b>
<b>2</b>	<b>Setting up WyzBee™ .....</b>	<b>9</b>
<b>2.1</b>	<b>Setup Requirements .....</b>	<b>9</b>
<b>2.2</b>	<b>Installing the CMSIS-DAP Drivers.....</b>	<b>9</b>
<b>2.3</b>	<b>Installing IDEs .....</b>	<b>10</b>
<b>3</b>	<b>Getting Started .....</b>	<b>11</b>
<b>3.1</b>	<b>Starting a New Project .....</b>	<b>11</b>
<b>3.2</b>	<b>Configuring IDE for WyzBee™ .....</b>	<b>11</b>
<b>3.3</b>	<b>Sample Project.....</b>	<b>15</b>
<b>3.4</b>	<b>Adding THINGS .....</b>	<b>17</b>
<b>4</b>	<b>Appendix A: Installing IDEs .....</b>	<b>18</b>
<b>4.1</b>	<b>Keil IDE .....</b>	<b>18</b>
4.1.1	Download and Installation.....	18
4.1.2	Configuring Keil IDE for WyzBee™ .....	21
<b>4.2</b>	<b>CoIDE .....</b>	<b>21</b>
4.2.1	Download and Installation.....	22
4.2.2	Configuring CoIDE for WyzBee™.....	24
<b>4.3</b>	<b>IAR Embedded Workbench.....</b>	<b>27</b>
4.3.1	Download and Installation.....	27
4.3.2	Configuration IAR Embedded Workbench for WyzBee™ .....	35
<b>5</b>	<b>Appendix B: WyzBee™ Headers.....</b>	<b>37</b>
<b>5.1</b>	<b>Pin Description .....</b>	<b>37</b>

## Table of Figures

<b>Figure 1:</b>	<b>WyzBee™ Baseboard with micro-B USB Cable .....</b>	<b>7</b>
<b>Figure 2:</b>	<b>WyzBee™ Baseboard's Top View .....</b>	<b>8</b>
<b>Figure 3:</b>	<b>WyzBee™ Baseboard's Bottom View .....</b>	<b>8</b>
<b>Figure 4:</b>	<b>CMSIS-DAP Drivers Installation Window.....</b>	<b>9</b>
<b>Figure 5:</b>	<b>WyzBee™ CMSIS-DAP Debug Port Detection.....</b>	<b>10</b>
<b>Figure 6:</b>	<b>Keil uVision: Selecting the Device .....</b>	<b>11</b>
<b>Figure 7:</b>	<b>Keil uVision: Options for Target – Utilities.....</b>	<b>12</b>
<b>Figure 8:</b>	<b>Keil uVision: CMSIS-DAP Debugger Settings .....</b>	<b>12</b>
<b>Figure 9:</b>	<b>Keil uVision: Options for Target – Debug.....</b>	<b>13</b>
<b>Figure 10:</b>	<b>Keil uVision: Options for Target – Debug.....</b>	<b>13</b>
<b>Figure 11:</b>	<b>Keil uVision: Options for Target – Target.....</b>	<b>14</b>
<b>Figure 12:</b>	<b>Keil uVision: Options for Target – Output.....</b>	<b>14</b>

Figure 13: Keil uVision: Options for Target – Linker .....	15
Figure 14: main.c of TriLED Project in Keil uVision4 .....	16
Figure 15: TriLED_App Function .....	16
Figure 16: Debug Cursor at main Function.....	17
Figure 17: Keil IDE Installation Window.....	18
Figure 18: Keil IDE Installation License Agreement .....	19
Figure 19: Keil IDE Installation Folder Selection .....	19
Figure 20: Keil IDE Customer Information.....	20
Figure 21: Keil IDE Installation Completed.....	20
Figure 22: Keil IDE Installation Completed.....	21
Figure 23: ULINK Driver Installation .....	21
Figure 24: CoIDE Installation Window.....	22
Figure 25: CoIDE Installation Folder Selection .....	23
Figure 26: CoIDE Installation Start.....	23
Figure 27: GCC Toolchain Path for CoIDE .....	24
Figure 28: CoIDE Version.....	24
Figure 28: CoIDE Configuration Button .....	24
Figure 29: CoIDE Configuration – Device.....	25
Figure 30: CoIDE Configuration – Link.....	25
Figure 31: CoIDE Configuration – Output.....	26
Figure 32: CoIDE Configuration – User .....	26
Figure 33: CoIDE Configuration – Debugger.....	26
Figure 34: CoIDE Configuration – Download.....	27
Figure 35: IAR Embedded Workbench Installation Window .....	28
Figure 36: IAR Embedded Workbench Installation Window .....	28
Figure 37: IAR Embedded Workbench License Agreement .....	29
Figure 38: IAR Embedded Workbench Installation Folder.....	29
Figure 39: IAR Embedded Workbench Installation Start .....	30
Figure 40: IAR Embedded Workbench – Dongle Drivers Installation.....	30
Figure 41: IAR Embedded Workbench Installation Completed .....	31
Figure 42: IAR Embedded Workbench – Device Software – 1 .....	31
Figure 43: IAR Embedded Workbench – Device Software – 2 .....	32
Figure 44: IAR Embedded Workbench – Language Selection .....	32
Figure 45: IAR Embedded Workbench – License Wizard .....	32
Figure 46: IAR Embedded Workbench – License Wizard (Choose a Product) .....	33
Figure 47: IAR Embedded Workbench – License Wizard (Register) .....	33
Figure 48: IAR Embedded Workbench: Registration .....	34
Figure 49: IAR Embedded Workbench: Registration Complete.....	35
Figure 50: IAR Embedded Workbench – Project Options .....	35
Figure 51: IAR Embedded Workbench – Options – 1.....	36
Figure 52: IAR Embedded Workbench – Options – 2.....	36
Figure 53: 32-pin WyzBee™ THING Header.....	37

## Table of Tables

Table 1: TriLED Connections to MCU.....	15
---	----

## 1 Introduction

The WyzBee™IoT platform is an industry-first single source offering with fully inclusive sensing, computing, communicating, and cloud support. The compact WyzBee™ board includes Redpine's Wireless Secure MCU (WiSeMCU™) with multi-protocol wireless module providing Wi-Fi, Bluetooth 4.1, and ZigBee connectivity, nine-axis inertial sensors, onboard temperature/humidity sensors, 3 axis accelerometer, an infrared receiver, a USB (debug) port, push-buttons, LEDs, and WyzBee™ THING™ expansion connector. The WiSeMCU module runs an embedded TCP/IP networking stack with SSL/TLS/HTTPS security, apart from complete Wi-Fi, BT 4.1, and ZigBee stacks.

The WyzBee™ THING expansion headers accommodate a host of other symbiotic devices, with a number of peripherals – called 'THINGS' – already available from Redpine including audio, GSM, GPS, capacitive touch display, rechargeable battery, and additional sensors. Application development is supported with a choice of development environments – IAR, Keil, and the free ColIDE from CoCoX.

The WiSeMCU™ module integrates PUF-based hardware security block that provides for unique, individual device entities – ensuring that each IoT device can be individually authenticated and software delivered to it that cannot run on any other device.

### 1.1 Features

#### 1.1.1 MCU Features

- ARM Cortex-M4F processor, running at a frequency of up to 160 MHz
- Integrated Floating Point Unit (FPU), Memory Protection Unit (MPU), Built-in Nested Vectored Interrupt Controller (NVIC)
- Debug options: JTAG and Embedded Trace Macrocells (ETM)
- 1MB on-chip flash program memory with flash accelerator and 32KB work flash memory
- 128 KB SRAM for code and data use
- CAN Interface with support for up to 2 channels
- Up to 32 high speed general purpose I/O ports.
- Multi-function Serial Interface with support for up to 6 channels (UART, CSIO (SPI), and I2C).
- Base timer (maximum 8 channels) supporting PWM, PPG, reload timer, PWC (up to 6 channels).
- Comprehensive Timers: Multi-function timer (MFT) with FRT, WFG, ICU, OCU modes supported.
- RTC, QPRC, Dual Timer supported.
- Up to 2 configurable Watchdog Timers.
- Analog peripherals: 12-bit, 11-channel Analog-to-Digital Converter (ADC)
- Security: Unique ID of the device (41 bit) is set
- Six low-power consumption modes: SLEEP, Timer, RTC, STOP, Deep Standby RTC, Deep Standby stop.

- 12-bit Digital to Analog Converter (DAC) with support for 1 channel
- DMA Controller with support for up to 8 channels
- CRC (Cyclic Redundancy Check) Accelerator
- External interrupt input pins: up to 14 pins
- Low-Voltage Detector (LVD) current: 100nA
- CMSIS-DAP Debug adapter: WyzBee™ comes with an on board CMSIS-DAP debug adapter for downloading and debugging applications, without the need for an external debugger.

**1.1.2 WLAN Features**

- Compliant to single-spatial stream IEEE 802.11 a/b/g/n with dual band (2.4 and 5 GHz) support.
- Support for 20MHz channel bandwidth.
- Transmit power up to +18dBm with integrated PA.
- Receive sensitivity of -97dBm.
- Supports Wi-Fi Direct™, Access point mode, WPA/WPA2-PSK, WPA/WPA2-Enterprise (EAP-TLS, EAP-FAST, EAP-TTLS, PEAP-MS-CHAP-V2).

**1.1.3 Bluetooth**

- Compliant to dual-mode Bluetooth 4.0.
- Transmit power up to 15dBm (class-1) with integrated PA.
- Receive sensitivity of -94 dBm.
- Basic Bluetooth profile embedded in device.

**1.1.4 ZigBee**

- Compliant to IEEE 802.15.4
- Transmit power up to 15 dBm with integrated PA.
- Receive sensitivity of -102 dBm.
- ZigBee Pro stack embedded

**1.1.5 General**

- U.FL connector for external antenna connection.
- Operating temperature range: -40°C to +85°C
- TCP/IP stack (IPv4/IPv6), HTTP/HTTPS, DHCP, ICMP, SSL 3.0/TLS1.2, Web sockets, IGMP, FTP Client, SNTP, DNS, embedded in the device.
- On Board Peripherals:
  - Tri Color LED

LED Color	Pin
Red	P41

Blue	P3F
Green	P3E

- Two push buttons (One for Reset and one for an External interrupt)

Push Button	Pin
SW1(External Interrupt)	P50
SW2 (Reset)	MCU_RESET_N

- IR receiver

IR Receiver	Pin
IR_OUT	P42

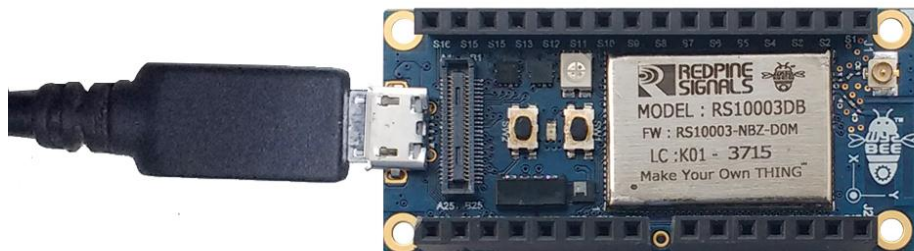
- 9 Axis Sensor
- 3 Axis Accelerometer
- Humidity and Temperature Sensor

Sensor	Pin
All three sensors use the I2C interface to interact with the MCU.	
Clock	P33
Data	P32

- Micro-B USB Full Speed Interface

## 1.2 WyzBee™ Board

WyzBee™ is a USB-powered device. Shown below is a WyzBee™ baseboard with the micro-B USB cable plugged in.



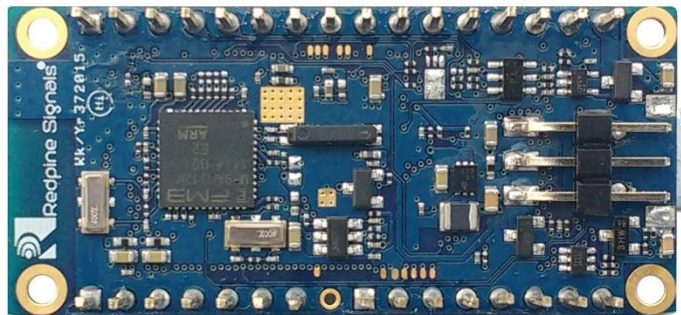
**Figure 1: WyzBee™ Baseboard with micro-B USB Cable**

### 1.3 WyzBee™ Top View



**Figure 2: WyzBee™ Baseboard's Top View**

### 1.4 WyzBee™ Bottom View



**Figure 3: WyzBee™ Baseboard's Bottom View**



## 2 Setting up WyzBee™

### 2.1 Setup Requirements

Setting up and working with WyzBee™ is easy. Before you start, make sure you have the following hardware and software components:

Hardware:

- The WyzBee™ baseboard
- 32/64-bit PC with minimum 2GB RAM and USB Port for Power, Downloading and Debugging

Software:

- Windows 7/8/8.1 Operating System.
- The CMSIS-DAP driver provided by Spansion. You can download the driver from <https://www.spansion.com/Support/microcontrollers/developmentenvironment/Pages/board-SK-FM4-U120-9B560.aspx>. More details are given in [Section 2.2](#).
- An IDE like Keil uVision, IAR Embedded Workbench or CoCoX CoIDE.

### 2.2 Installing the CMSIS-DAP Drivers

Follow the steps below to download and install the CMSIS-DAP Drivers.

- 1) Download the complete set of drivers and tools from the following link:

(USB drivers for virtual COM port and CMSIS-DAP)

<https://www.spansion.com/Support/microcontrollers/developmentenvironment/Pages/board-SK-FM4-U120-9B560.aspx>

**Note:** If the device gets detected as an unknown device, update the drivers from the device manager and point to the location of the newly downloaded drivers.

- 2) Windows USB drivers that are specific to WyzBee™ need to be installed for the detection of debugging port. In the downloaded folder, navigate to the “drivers” folder and double-click on the driverinstaller.exe file. The window below will appear.



**Figure 4: CMSIS-DAP Drivers Installation Window**

- 3) Click the Next button.
- 4) A “Publisher cannot be verified”, warning might appear depending on the Windows Security Settings. Select the “Install this driver software anyway” option. This installs the cmsis-dap and usbdirect drivers.
- 5) Click the Finish button after the drivers’ installation is completed.
- 6) Connect the micro-B USB cable between the WyzBee™ USB port and the PC. Verify that the board is detected under the “Ports” section of the Windows Device Manager.



**Figure 5: WyzBee™ CMSIS-DAP Debug Port Detection**

### 2.3 Installing IDEs

WyzBee™ applications can be developed using various IDEs like CoIDE, Keil and IAR. Refer to [Appendix A](#) for instructions on downloading and installing these tools..

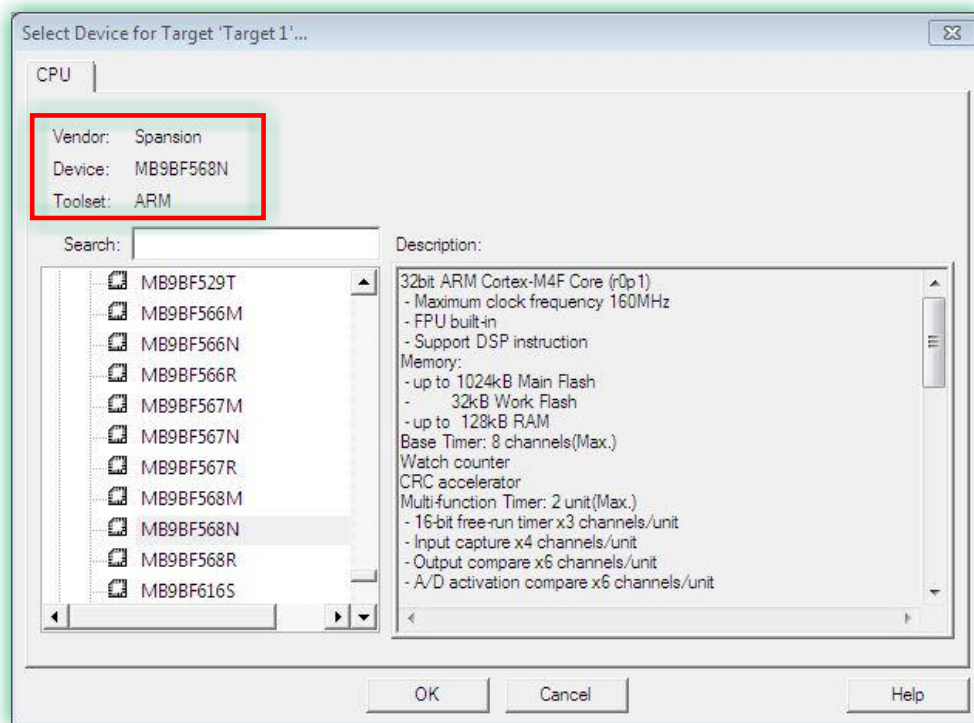
### 3 Getting Started

This section helps in getting started quickly with WyzBee™. It describes the process for starting a project, configuring the IDE for WyzBee™ and then working with an example project.

It is necessary to know your way around one of the supported IDE's in order to work on WyzBee™. The steps below use the Keil uVision 4 IDE as an example to download and debug a sample application on WyzBee™.

#### 3.1 Starting a New Project

- 1) Start the Keil uVision 4 IDE.
- 2) Click on “New uVision Project” from the “Project” dropdown menu. A popup window appears giving you an option to select the location of the project. Select the path you would like and click “Save”.
- 3) A new window opens for selecting the device. Scroll down the list and select “MB9BF568N” as shown below.



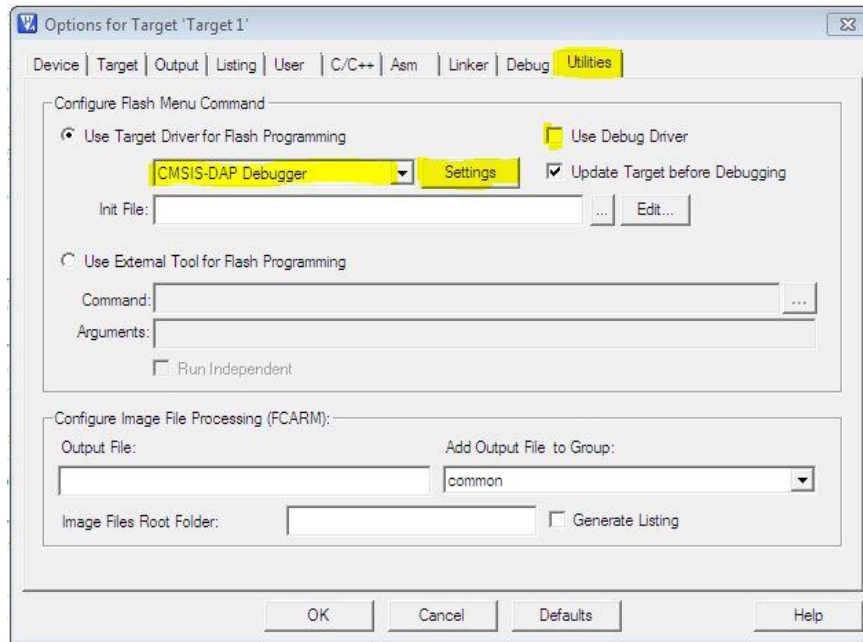
**Figure 6: Keil uVision: Selecting the Device**

- 4) Click OK and you are now ready to start configuring the IDE for WyzBee™.

#### 3.2 Configuring IDE for WyzBee™

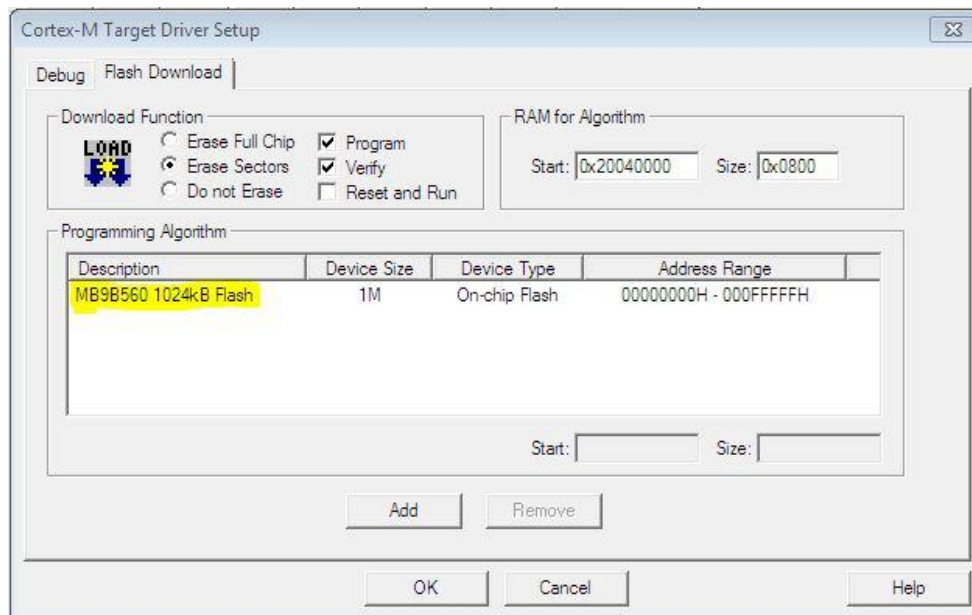
The Keil IDE is used here as an example. The process for CoIDE and IAR Embedded Workbench is explained in [Appendix A](#).

- 1) In the Keil uVision IDE window, click on “Options for Target”.
- 2) In the new window that opens, click on the “Utilities” tab. Uncheck the “Use Debug Driver” option.
- 3) Next, in the dropdown menu for “Use Target Driver for Flash Programming”, select “CMSIS-DAP Debugger” and click “Settings”.



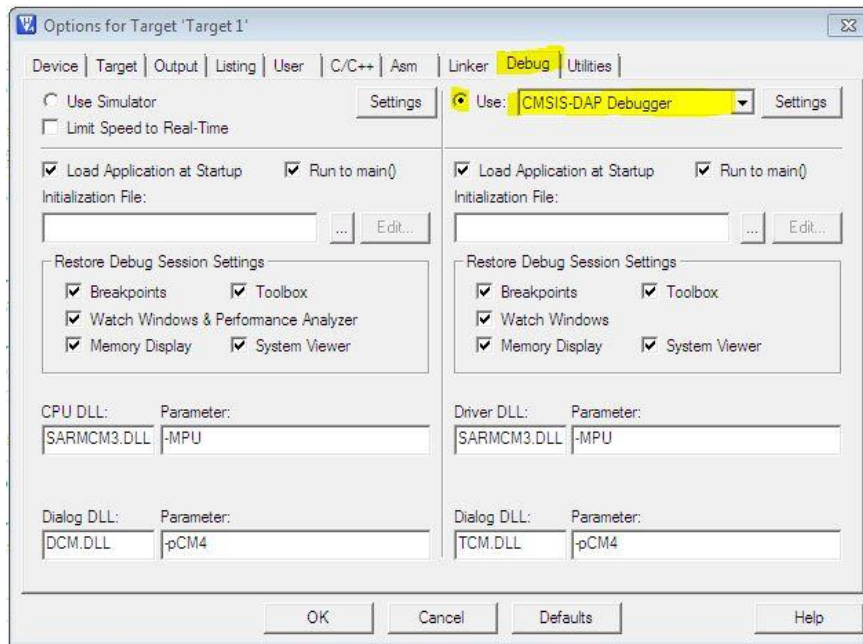
**Figure 7: Keil uVision: Options for Target – Utilities**

- 4) In the popup window, click “Add” and select the device name highlighted in the image below. Click OK.



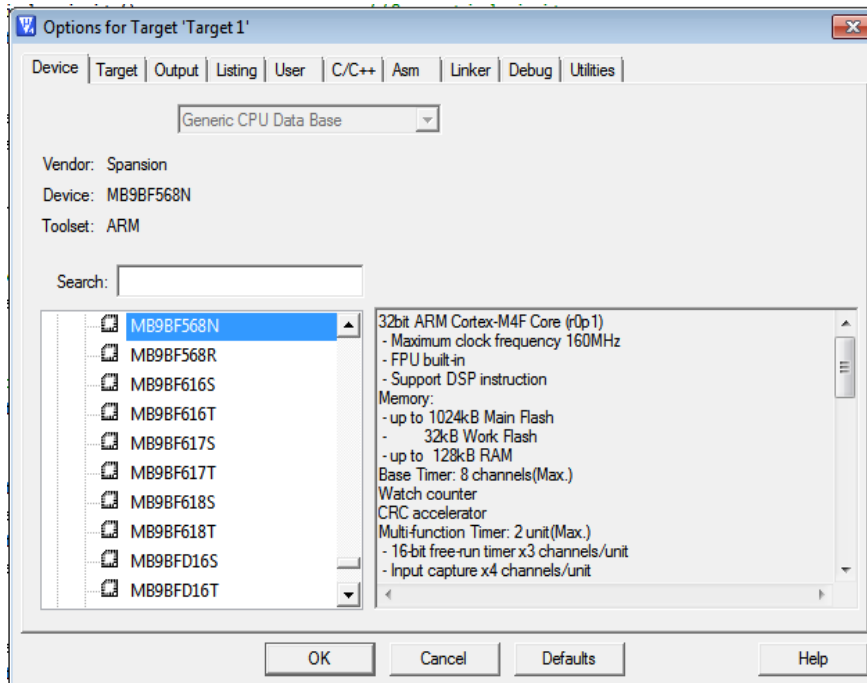
**Figure 8: Keil uVision: CMSIS-DAP Debugger Settings**

- 5) Next, click the “Debug” tab and select “Use” and “CMSIS-DAP Debugger” as shown below.



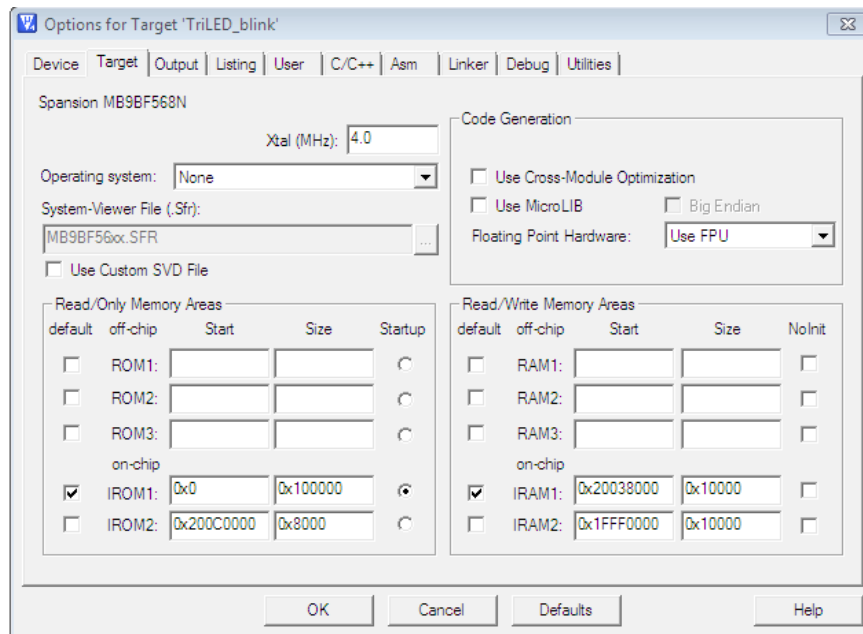
**Figure 9: Keil uVision: Options for Target – Debug**

- 6) Click on the “Device” tab and ensure that the settings are as shown in the image below.



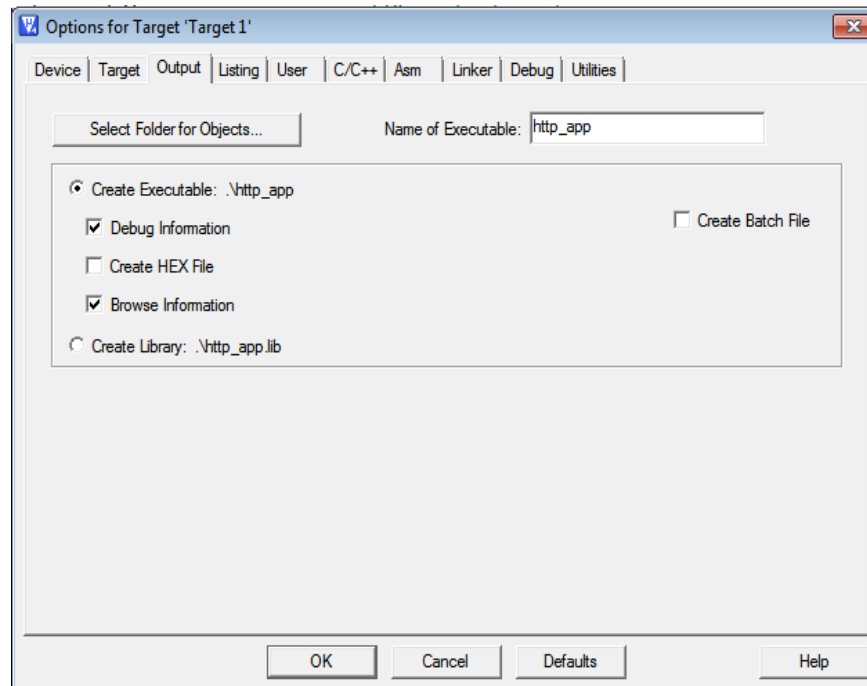
**Figure 10: Keil uVision: Options for Target – Debug**

- 7) Click on the “Target” tab and ensure all settings are as shown in the image below.



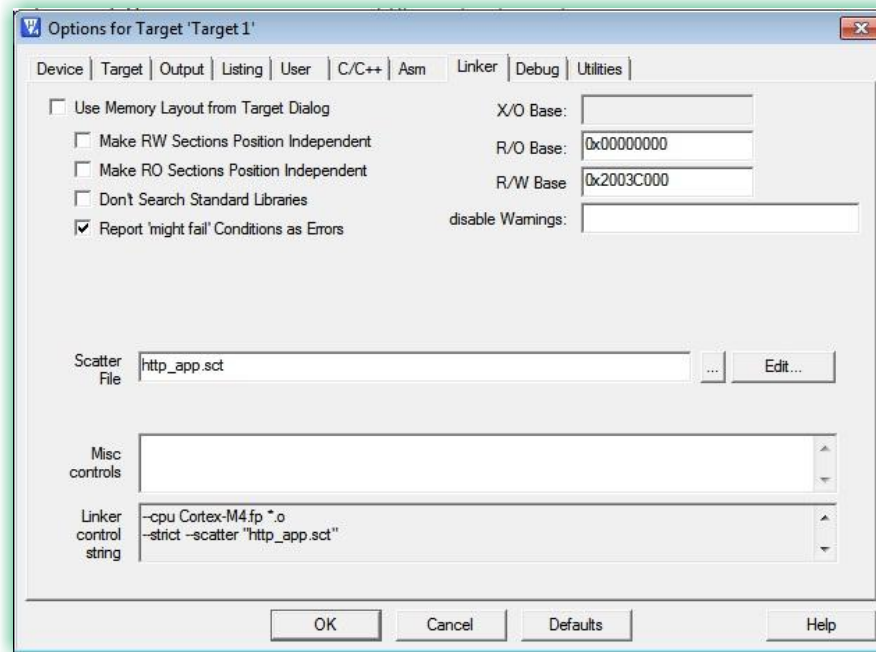
**Figure 11: Keil uVision: Options for Target – Target**

- 8) Click on the “Output” tab and ensure all settings are as shown in the image below.



**Figure 12: Keil uVision: Options for Target – Output**

- 9) Click on the “Linker” tab and ensure all settings are as shown in the image below.



**Figure 13: Keil uVision: Options for Target – Linker**

The IDE is now configured for WyzBee™. You can now start writing your application!

### 3.3 Sample Project

A sample project, TriLED.zip, which blinks the onboard TriLED is provided to help you quickly get started on WyzBee™. The details of the pins of the MCU connected to the TriLED are given below:

LED Color	MCU Pin
Red	P41
Green	P3E
Blue	P3F

**Table 1: TriLED Connections to MCU**

The project, when run, blinks the LEDs one at a time with a certain delay. Follow the steps below to compile, flash and run the example project.

- 1) Download the blinky project (TriLED.zip) from the URL above and extract it.
- 2) Double-click the Keil uVision4 project file. This opens the Keil IDE.  
\$(Extracted\_Folder)\TriLed\IDE\Keil\TriLed.uvproj
- 3) Open main.c in the IDE from the Project menu, as shown in the image below.

```

16 /*
17 .....
18 *
19 *
20 *
21 * File      : main.c
22 * Version   : V1.00
23 * History   :
24 * 2015-09-01 : V1.00   First version.
25 .....
26 * Note(s)   :
27 .....
28 */
29
30
31 /*
32 .....
33 *
34 *
35 *
36 .....
37 #include <Board_Init.h>
38 #include <TriLED_App.h>
39
40 int main()
41 {
42
43     Board_init();
44
45     TriLED_App();
46
47     return 0;
48 }
49
50

```

**Figure 14: main.c of TriLED Project in Keil uVision4**

- 4) The TriLED\_App() function controls all the frontend functioning of the application. It initializes the necessary drivers and configures WyzBee™. The source code is shown in the image below.

```

100 void TriLED_App(void)
101 {
102     while(1)
103     {
104         TriLEDGpio_Put(3E,GPIO_LOW);           // Toggling Red led
105         Delay(1000);                           // delay
106         TriLEDGpio_Put(3E,GPIO_HIGH);
107         Delay(1000);
108         TriLEDGpio_Put(3F,GPIO_LOW);           // Toggling Green led
109         Delay(1000);
110         TriLEDGpio_Put(3F,GPIO_HIGH);
111         Delay(1000);
112         TriLEDGpio_Put(41,GPIO_LOW);          // Toggling Blue led
113         Delay(1000);
114         TriLEDGpio_Put(41,GPIO_HIGH);
115         Delay(1000);
116     }
117 }
118
119

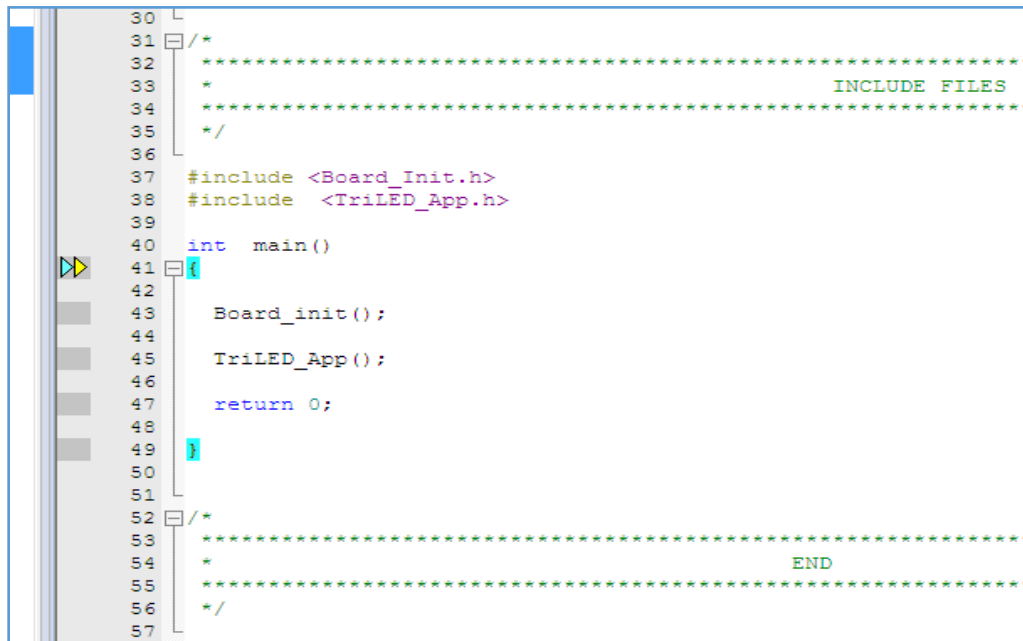
```

**Figure 15: TriLED\_App Function**

- 5) TriLED\_App() Function:
  - a. The TriLEDGpio\_Put function is used to change the value assigned to the pins. GPIO\_LOW indicates LED On and GPIO\_HIGH indicates LED Off.



- 6) Configure Keil for WyzBee™ as explained in Section 3.2.
- 7) Compile the project by clicking on Project → Build Target.
- 8) After successful compilation, click on Flash → Erase to Erase the MCU's Flash contents.
- 9) Next, click on Debug → Start/Stop Debug Session to download the application to the MCU. The IDE now shows the debug cursor pointing to the main function in the main.c file.



```
30 L
31 /*
32 .....
33 *                               INCLUDE FILES
34 .....
35 */
36
37 #include <Board_Init.h>
38 #include <TriLED_App.h>
39
40 int main()
41 {
42
43     Board_init();
44
45     TriLED_App();
46
47     return 0;
48
49 }
50
51
52 /*
53 .....
54 *                               END
55 .....
56 */
57
```

**Figure 16: Debug Cursor at main Function**

- 10) Use the Run (Ctrl+F5), Step-in (F11), Step-out (F10) and Step-over (Ctrl+F11) options to execute and debug the application.

For more details on how to use Keil uVision4 IDE, refer the document from the following link:

<http://www.keil.com/product/brochures/uv4.pdf>

You can now start writing your own Application using the API libraries provided. The APIs are explained in WyzBee API Guide document.

### 3.4 Adding THINGS

The WyzBee™ THING expansion headers accommodate a host of other symbiotic devices, with a number of peripherals – called ‘Things’ – already available from Redpine including audio, GSM, GPS, capacitive touch display, rechargeable battery, and additional sensors.

Adding THINGS is as simple as stacking one board on top of the other. Care needs to be taken to ensure that the interfaces being used for one THING are not being used by another THING when stacking multiple THINGS.

Details on the THINGS are available in their individual documents.

## 4 Appendix A: Installing IDEs

This section describes the steps for downloading and installing the IDEs<sup>1</sup> which can be used with WyzBee™.

### 4.1 Keil IDE

The Keil IDE from ARM can be used for IoT application development and supports both C and C++ languages.

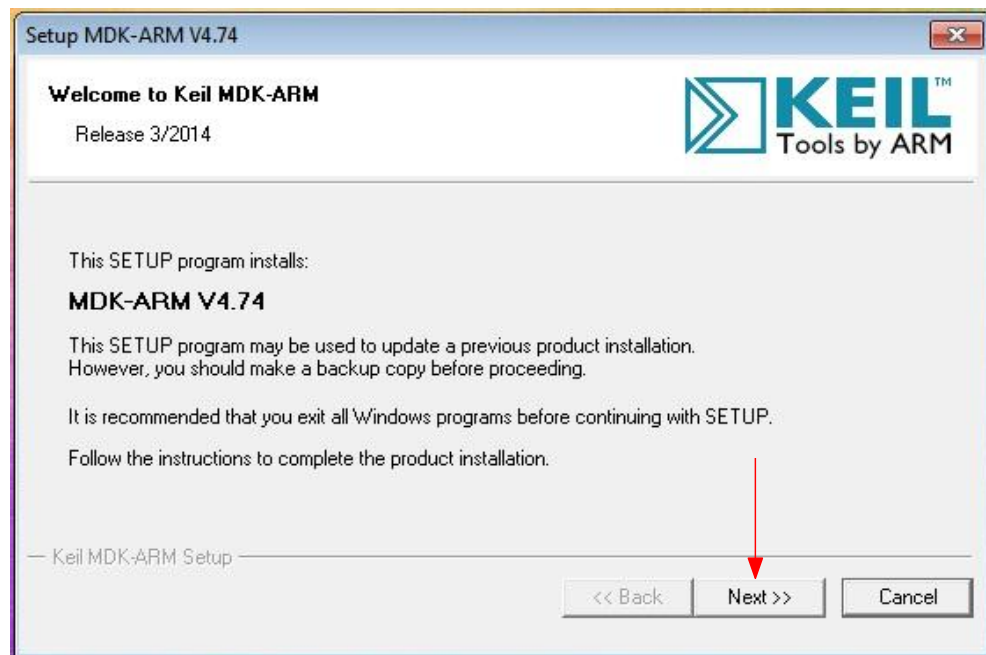
#### 4.1.1 Download and Installation

Evaluation version of Keil IDE can be downloaded from <https://www.keil.com>. The following steps have been described for Keil version 4.7.4.

We strongly recommend ensuring you are downloading the MDK-ARM V4.74 setup file.

You need to register yourself to generate the setup file to be downloaded.

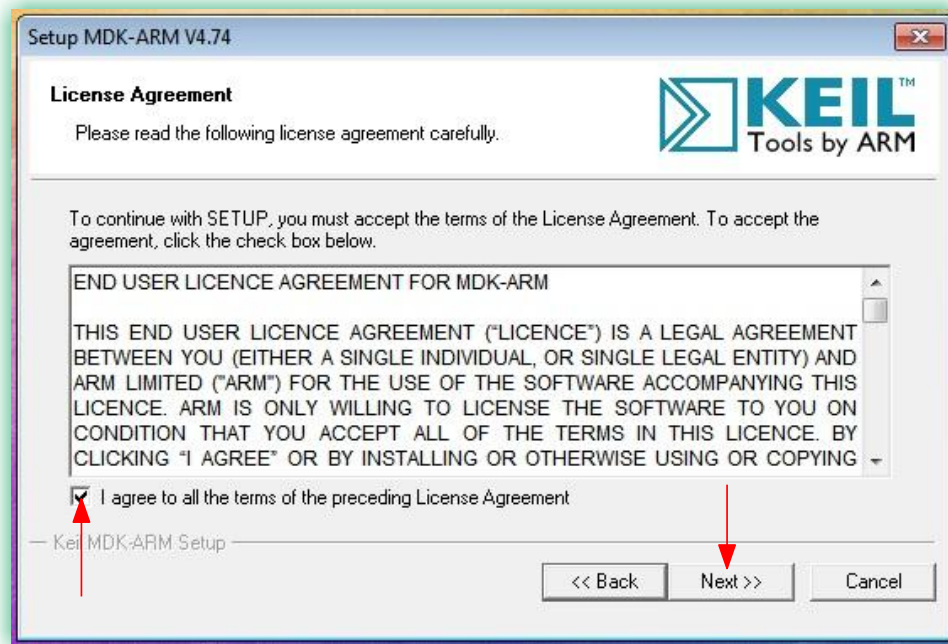
- 1) Start the installer. If any security warnings appear, click on Run.
- 2) In the Installer window, click Next.
- 3) Click Next again to continue the installation.



**Figure 17: Keil IDE Installation Window**

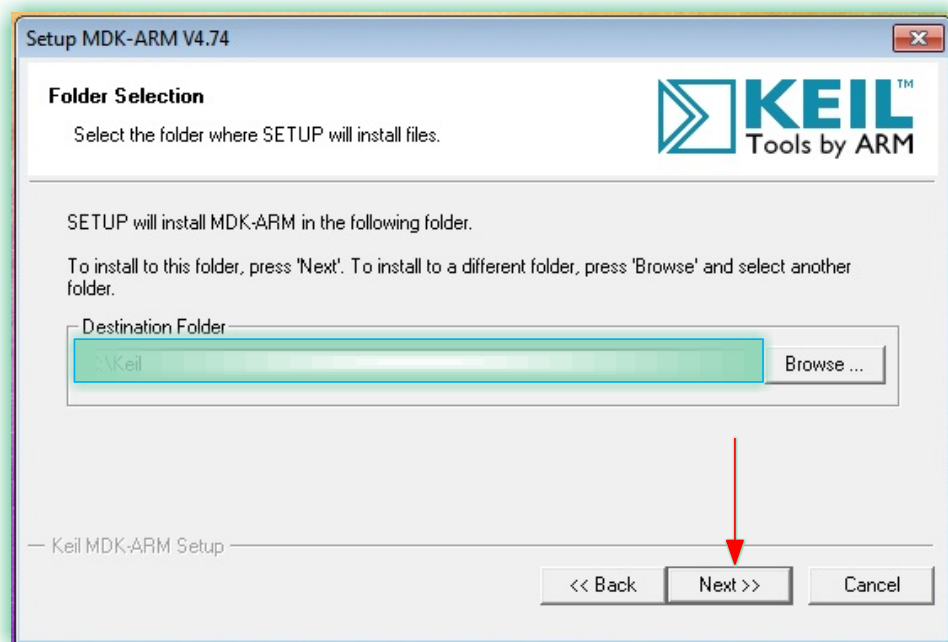
- 4) Check the “I agree to all the terms...” option and click Next.

<sup>1</sup> Keil and IAR impose a code size limitation of 32KB on the evaluation versions of their IDEs



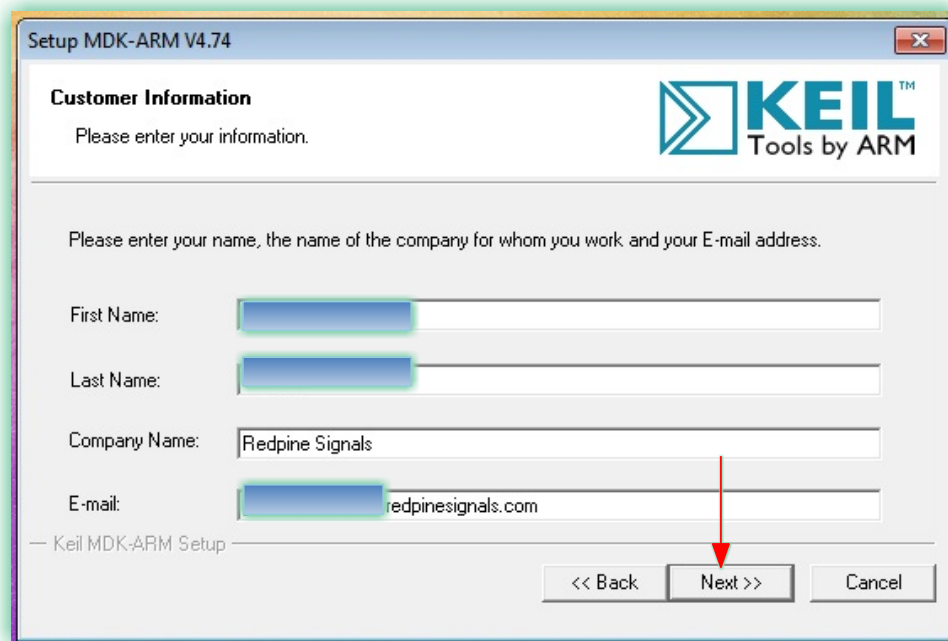
**Figure 18: Keil IDE Installation License Agreement**

- 5) In the next window, you have the option of changing the folder in which the IDE will be installed. Change it if required and click Next.



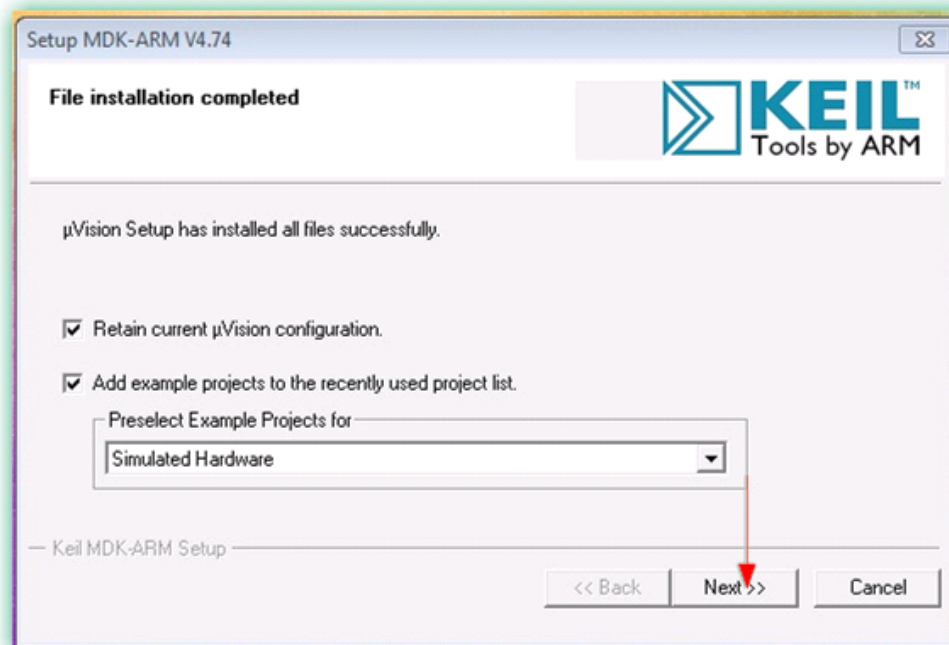
**Figure 19: Keil IDE Installation Folder Selection**

- 6) Enter your details in the next window and click Next to start the installation process.



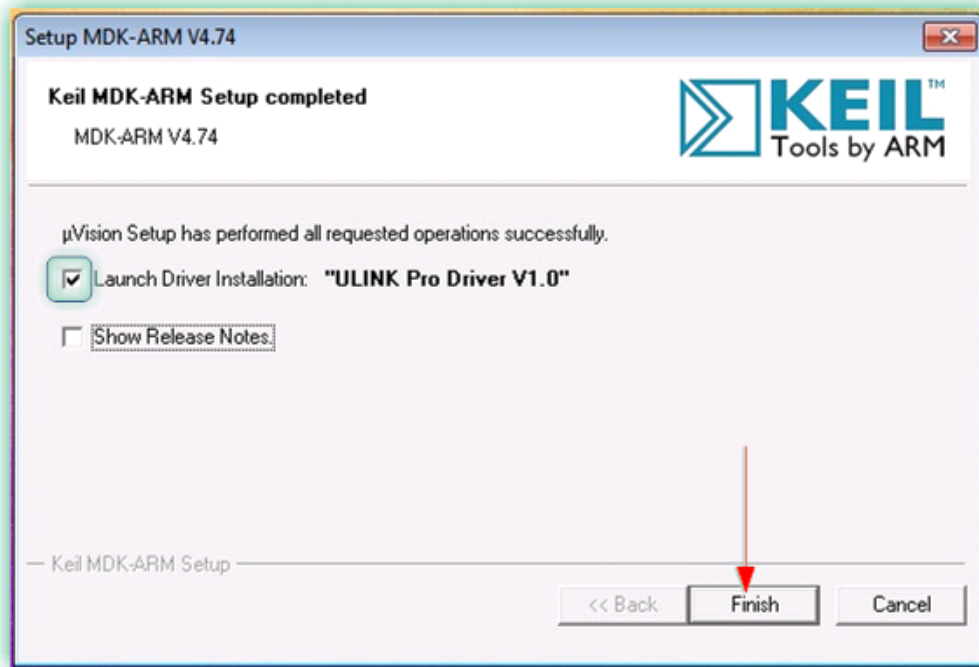
**Figure 20: Keil IDE Customer Information**

- 7) After the installation is completed, click Next again.



**Figure 21: Keil IDE Installation Completed**

- 8) Now, select the "Launch Driver Installation: ULINK Pro Driver V1.0" option and click Finish.



**Figure 22: Keil IDE Installation Completed**

- 9) In the new window that opens, click Install to continue with the installation of the ULINK drivers.



**Figure 23: ULINK Driver Installation**

#### 4.1.2 Configuring Keil IDE for WyzBee™

The process for configuring Keil IDE for WyzBee™ is explained in [Section 3.2](#).

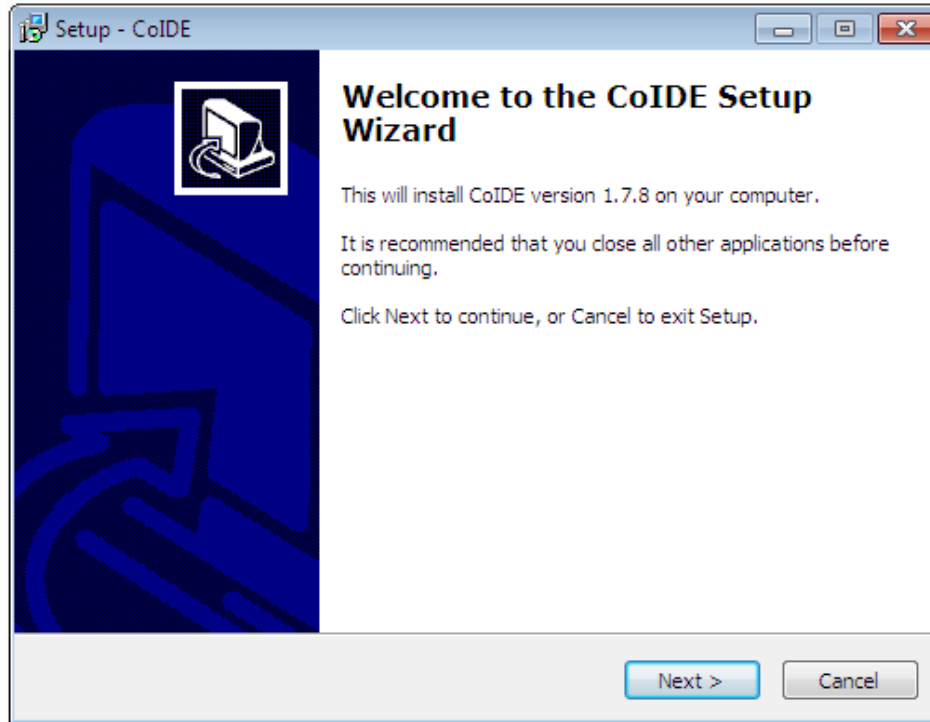
#### 4.2 CoIDE

The CoIDE from Coocox is a free IDE and can be used for IoT application development. CoIDE supports both C and C++ languages and does not have any code size limitations.

#### 4.2.1 Download and Installation

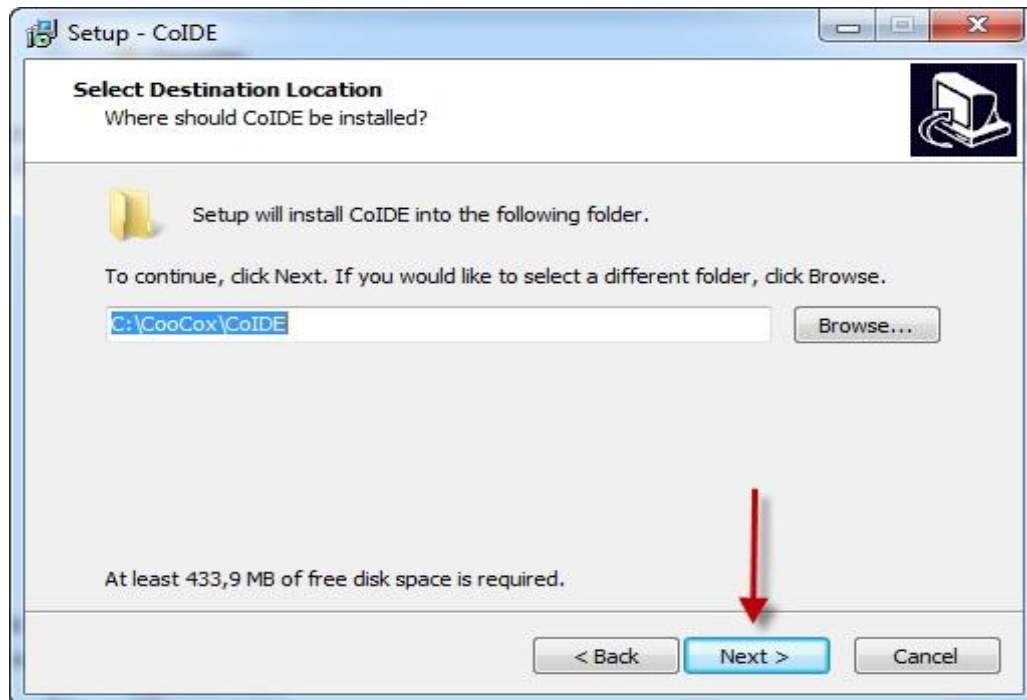
CoIDE can be downloaded from <http://www.coocox.org> . The following steps have been described for CoIDE version 1.7.8.

- 1) Start the installer. If any security warnings appear, click on Run.
- 2) In the Installer window, click Next.



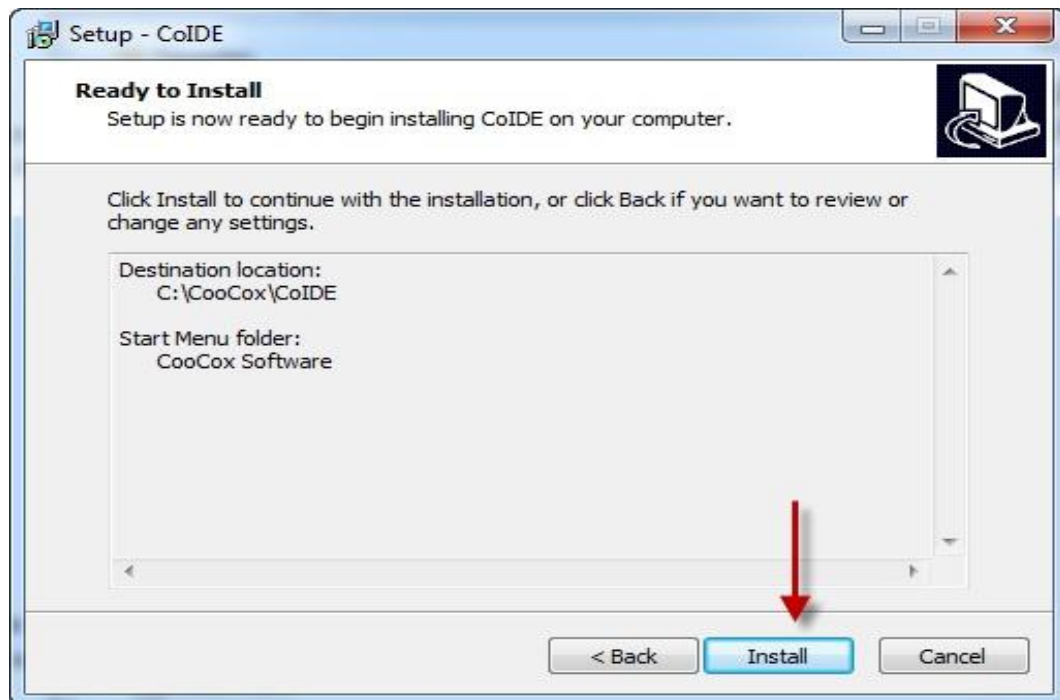
**Figure 24: CoIDE Installation Window**

- 3) In the next window, you have the option of changing the folder in which the IDE will be installed. Change it if required and click Next.



**Figure 25: CoIDE Installation Folder Selection**

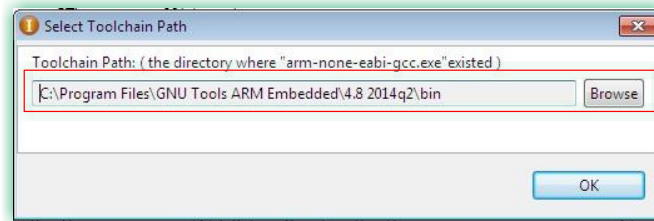
4) In the new window, click Install to start the Installation of CoIDE.



**Figure 26: CoIDE Installation Start**

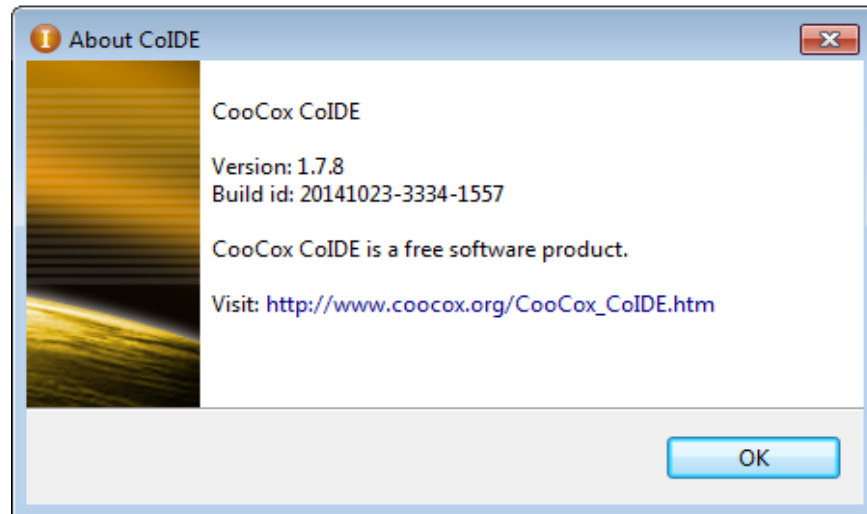
5) Click Finish after the installation is completed.

- 6) CoIDE doesn't come with an integrated GCC compiler. Download and install the relevant GCC toolchain for Windows from <https://launchpad.net/gcc-arm-embedded/>
- 7) Once the installation of the GCC Toolchain is completed, open CoIDE and click on "Select Toolchain Path" under "Project". In the new dialog box that opens, enter the path where the GCC Toolchain was installed.



**Figure 27: GCC Toolchain Path for CoIDE**

- 8) To verify the downloaded version, click Help -> About CoIDE



**Figure 28: CoIDE Version**

#### 4.2.2 Configuring CoIDE for WyzBee™

Follow the steps below to configure CoIDE for WyzBee™.

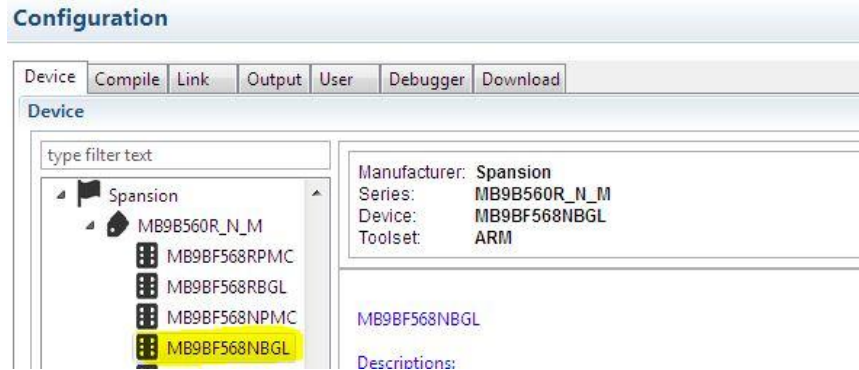
- 1) Open CoIDE and click on the Configuration button.



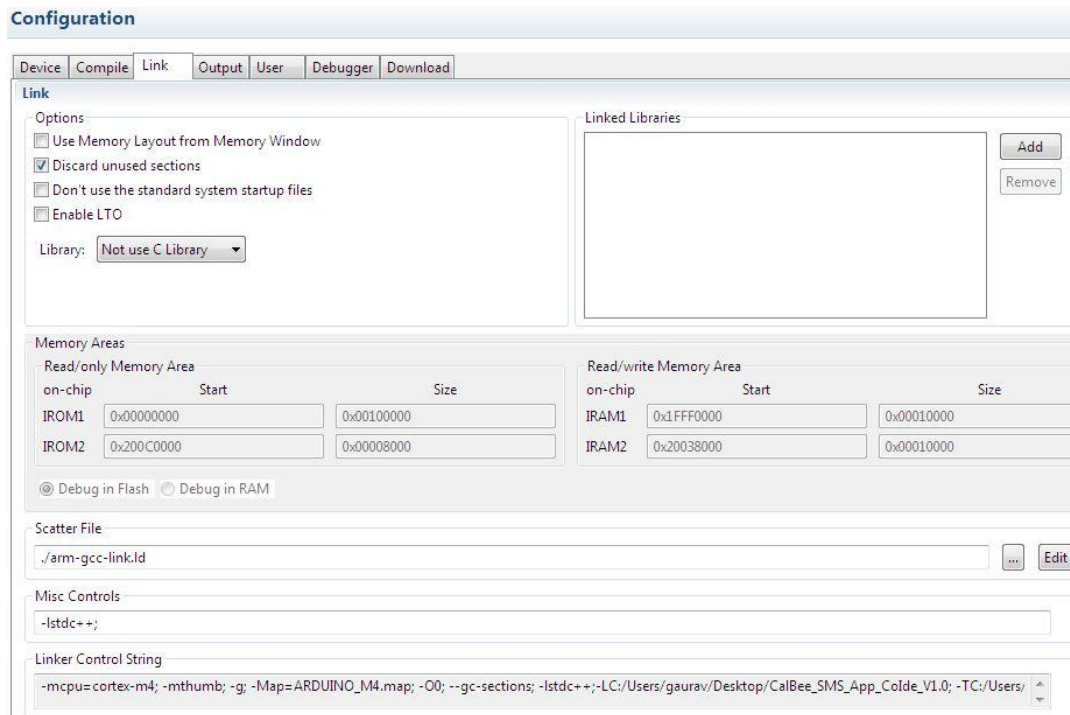
**Figure 29: CoIDE Configuration Button**

- 2) In the new window that opens, ensure that the settings on each tab match the settings in the images below.





**Figure 30: CoIDE Configuration – Device**



**Figure 31: CoIDE Configuration – Link**

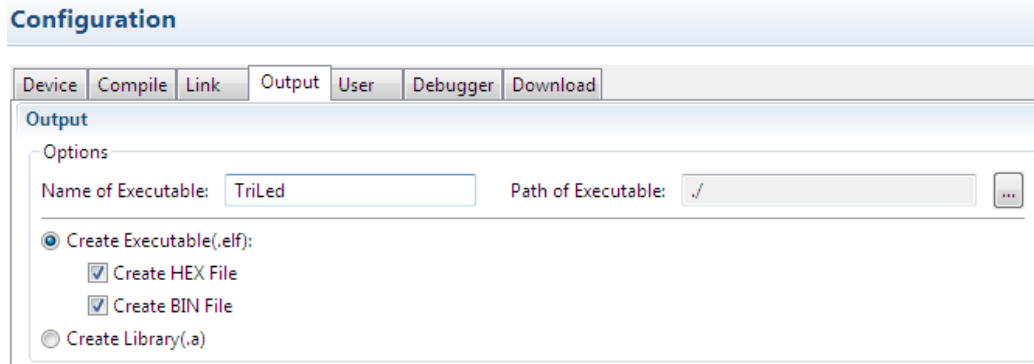


Figure 32: CoIDE Configuration – Output

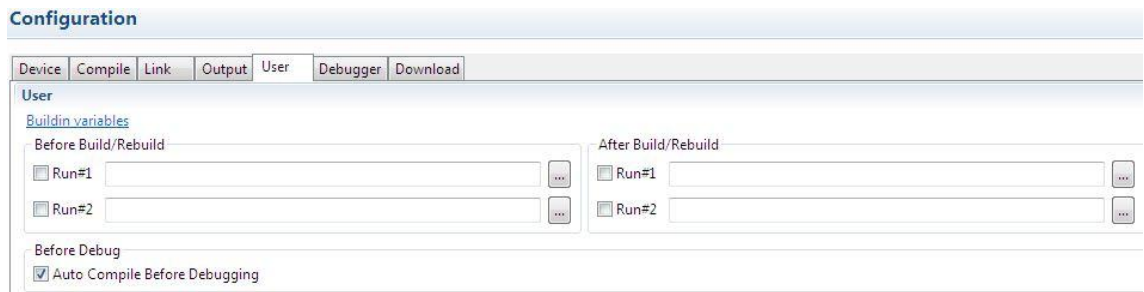


Figure 33: CoIDE Configuration – User

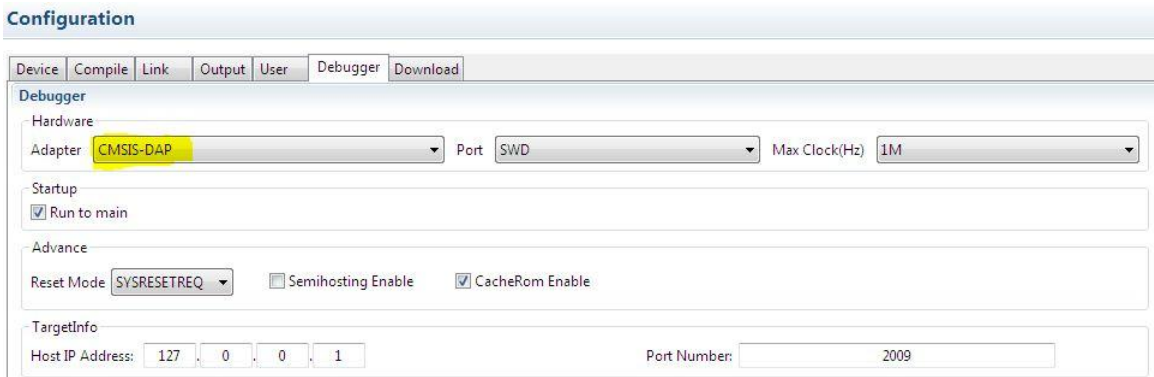
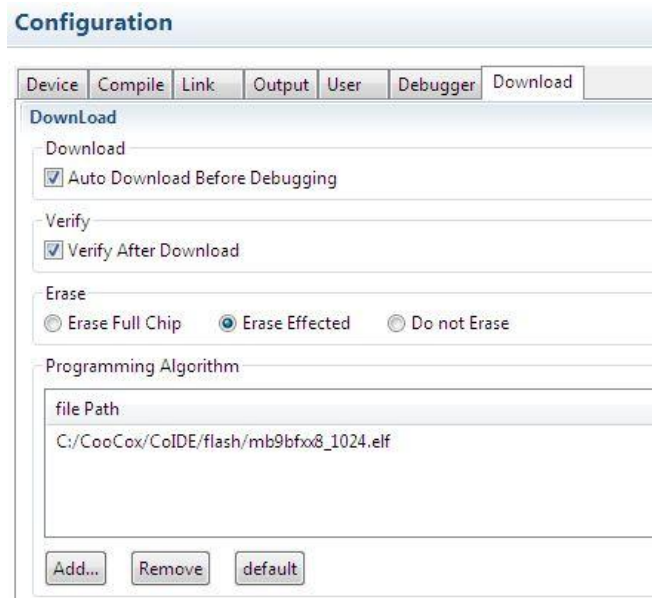


Figure 34: CoIDE Configuration – Debugger



**Figure 35: CoIDE Configuration – Download**

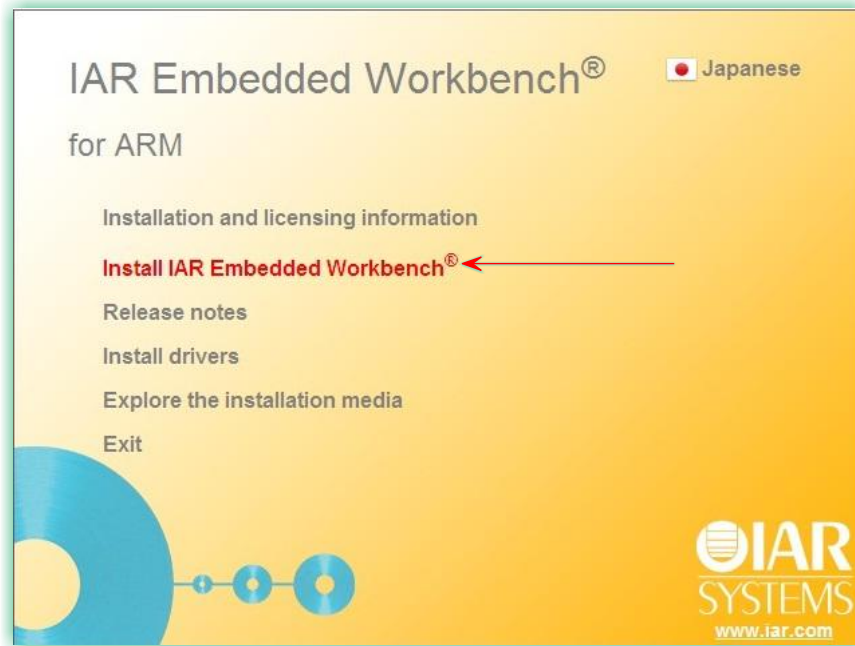
### 4.3 IAR Embedded Workbench

IAR Embedded Workbench is a development environment that includes a C/C++ compiler and debugger.

#### 4.3.1 Download and Installation

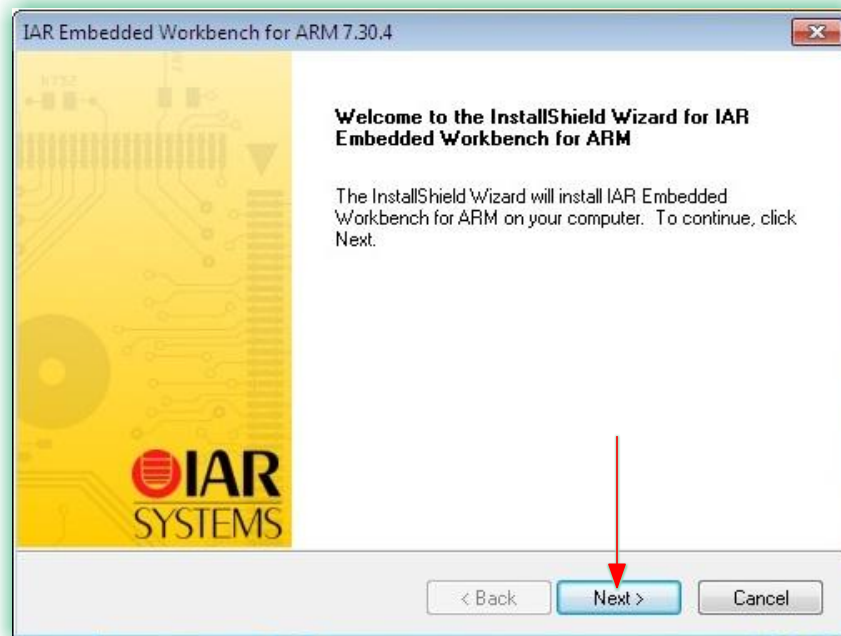
The IAR Embedded Workbench can be downloaded from <https://www.iar.com>. The following steps have been described for IAR version 7.30.

- 1) Start the installer. If any security warnings appear, click on Run.
- 2) In the installation window, selection the “Install IAR Embedded Workbench” option.



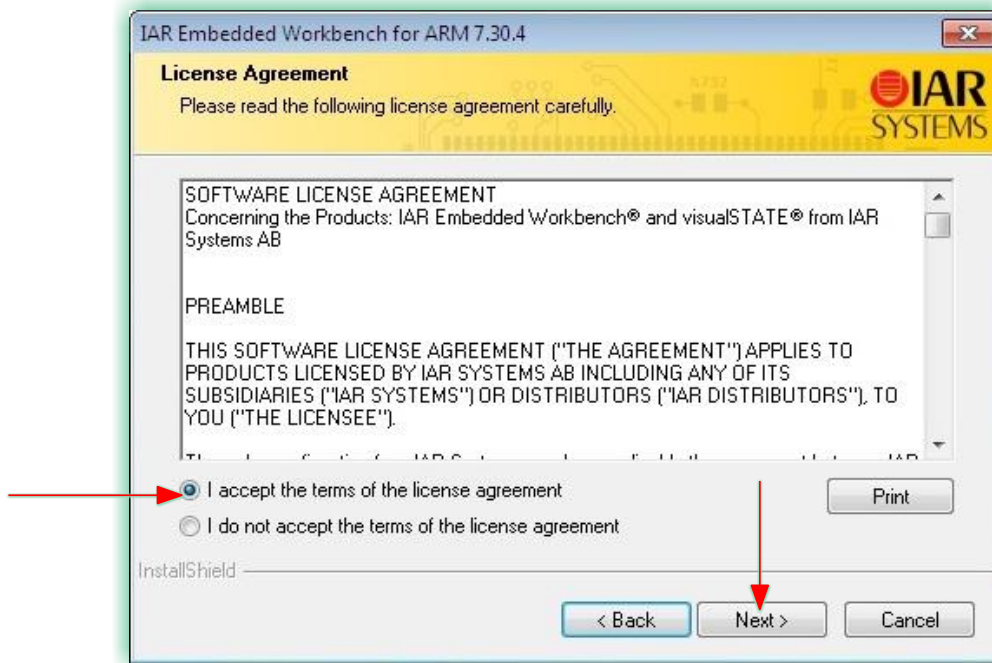
**Figure 36: IAR Embedded Workbench Installation Window**

- 3) In the new window, click Next.



**Figure 37: IAR Embedded Workbench Installation Window**

- 4) Check the “I accept the terms of the license agreement” option and click Next.



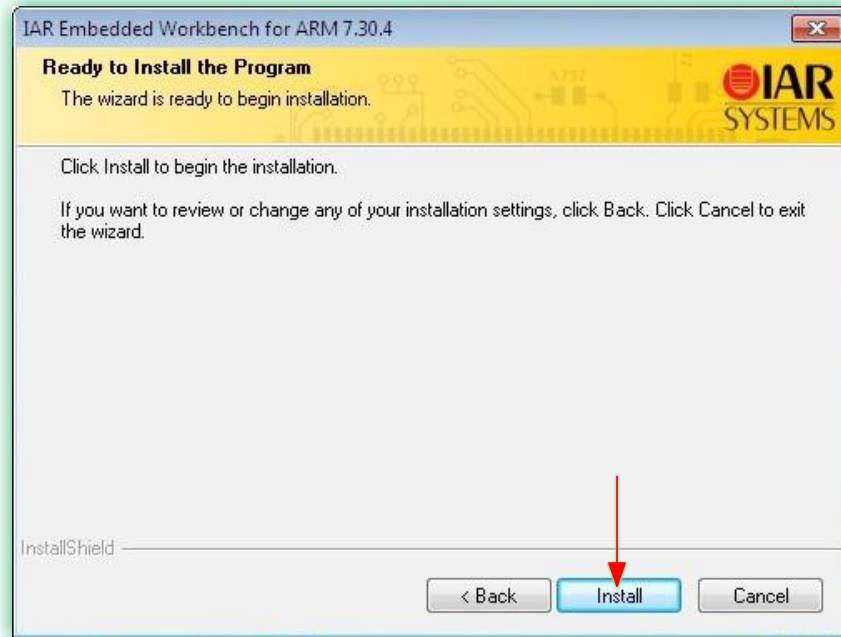
**Figure 38: IAR Embedded Workbench License Agreement**

- 5) In the next window, you have the option of changing the folder in which the IDE will be installed. Change it if required and click Next.



**Figure 39: IAR Embedded Workbench Installation Folder**

- 6) Click Next in the new window and then click Install to start the installation process.



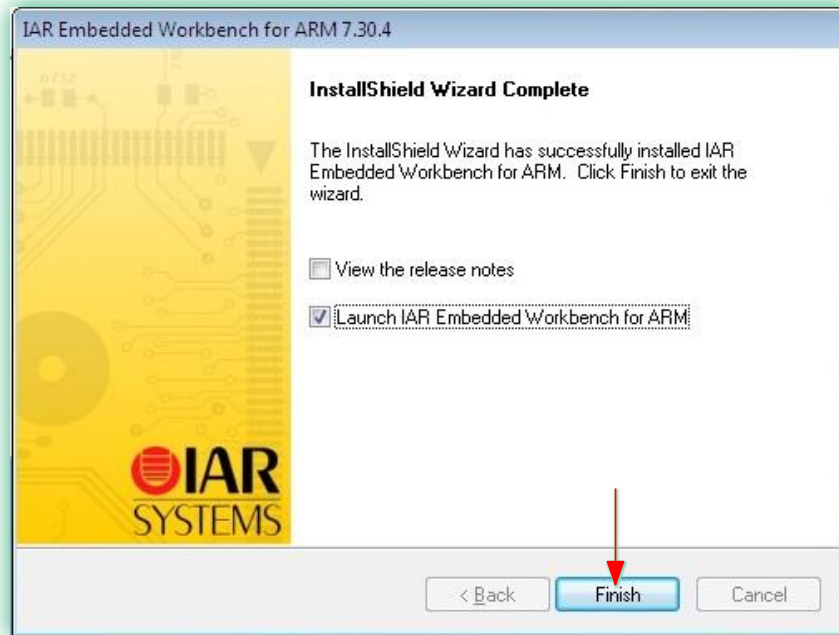
**Figure 40: IAR Embedded Workbench Installation Start**

- 7) Wait for the installation to be completed. You will be requested to remove any USB dongles connected to the PC. Remove them and click Yes.



**Figure 41: IAR Embedded Workbench – Dongle Drivers Installation**

- 8) This will start the installation of the dongle drivers. Once completed, select the “Launch IAR Embedded Workbench for ARM” option and click Finish to complete the installation of IAR Embedded Workbench.



**Figure 42: IAR Embedded Workbench Installation Completed**

- 9) Next, you will be prompted for installation of device software. Click Install.

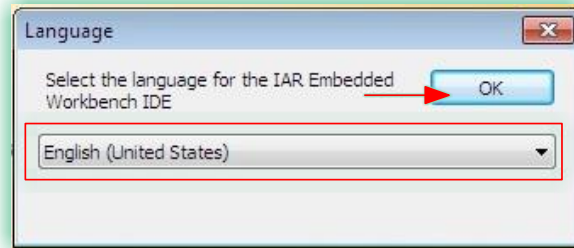


**Figure 43: IAR Embedded Workbench – Device Software – 1**



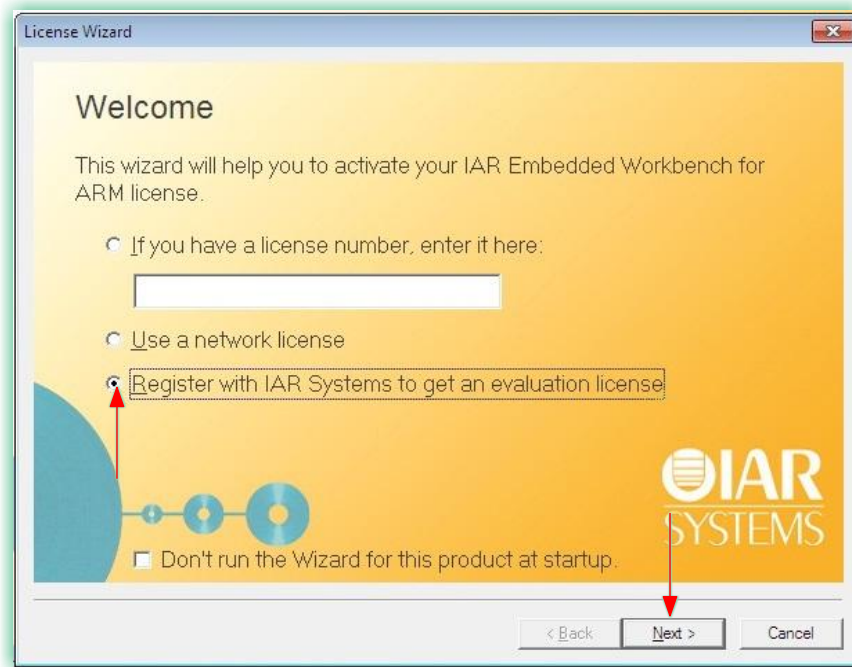
**Figure 44: IAR Embedded Workbench – Device Software – 2**

10) Select the Language of your preference and click OK.



**Figure 45: IAR Embedded Workbench – Language Selection**

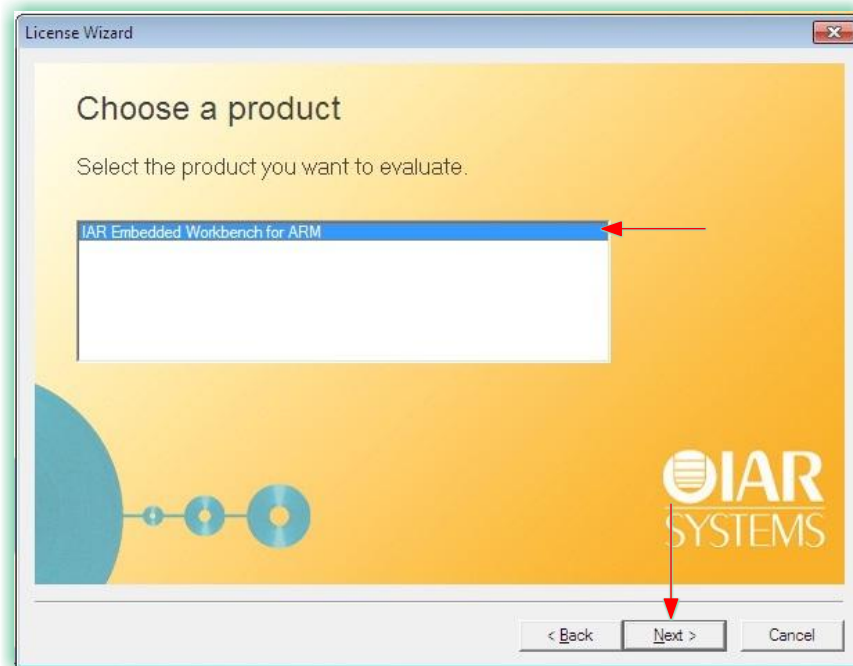
11) The IAR Embedded Workbench window opens, followed by the License Wizard. Click Next.



**Figure 46: IAR Embedded Workbench – License Wizard**

12) Click Next again.





**Figure 47: IAR Embedded Workbench – License Wizard (Choose a Product)**

13) In the new window, click Register.



**Figure 48: IAR Embedded Workbench – License Wizard (Register)**

- 14) Clicking Register opens a web browser for the Registration process. Select the “Code Size Limited” option and enter the rest of the details.

**Register for Evaluation**

Evaluation license type \*

Time limited (30 days)  
IAR Embedded Workbench for ARM, v. 7.30, Evaluation Edition

Code size limited  
IAR Embedded Workbench for ARM, v. 7.30, 32K Kickstart Edition

First name \*

Last name \*

Title

Email \*

**Figure 49: IAR Embedded Workbench: Registration**

- 15) Once the details are submitted, a confirmation email is sent to the registered email address. Open the confirmation email and click on the confirmation link.
- 16) Next, a page opens with a License Key.

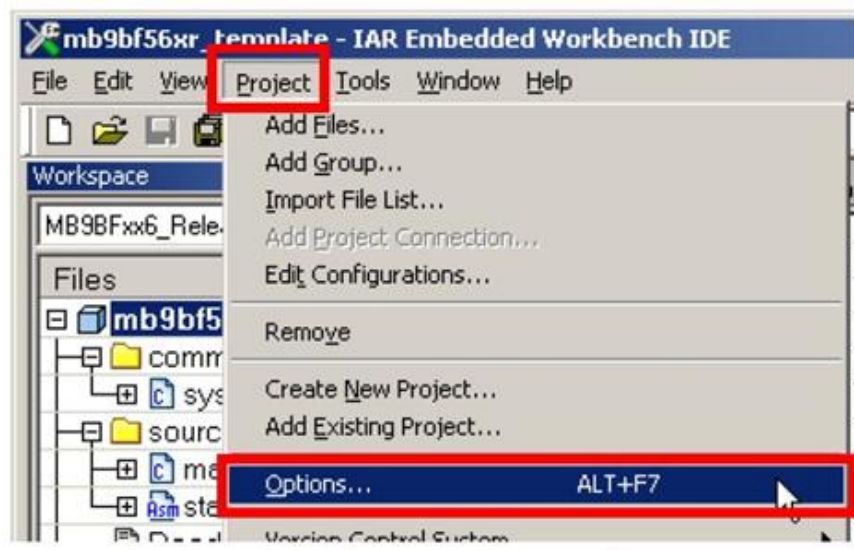


**Figure 50: IAR Embedded Workbench: Registration Complete**

- 17) Copy this key and paste it in the License Wizard and click Next to complete the installation and registration process for IAR Embedded Workbench.

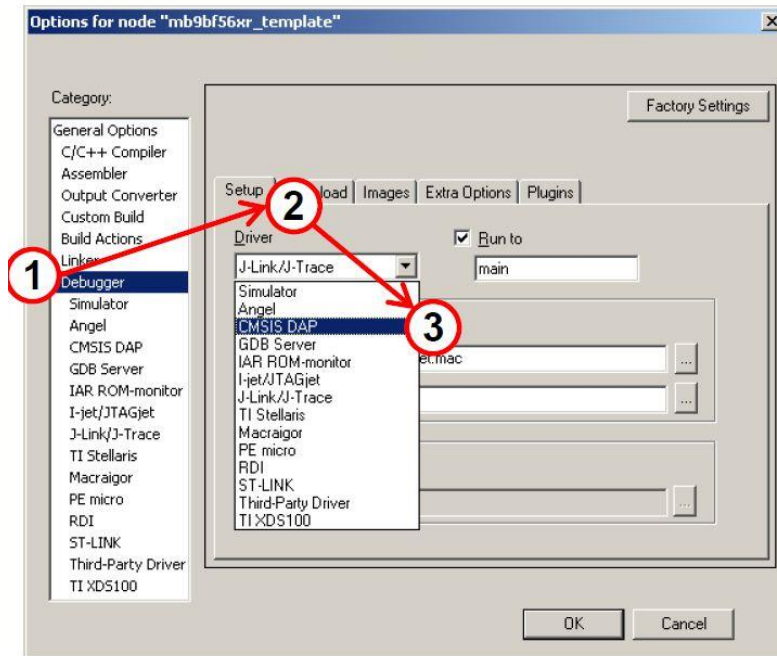
#### 4.3.2 Configuration IAR Embedded Workbench for WyzBee™

- 1) Open the IAR Embedded Workbench and click on Project → Options

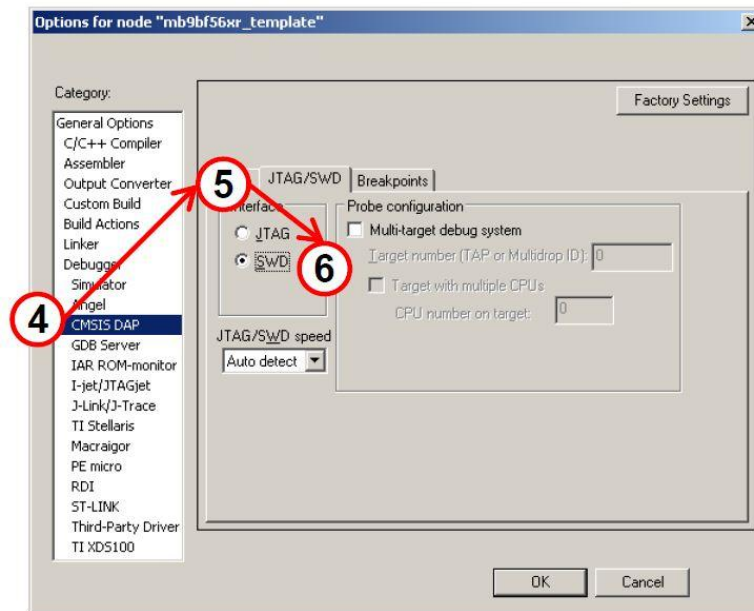


**Figure 51: IAR Embedded Workbench – Project Options**

- 2) In the Options window that opens, ensure that all settings are as per the images shown below.



**Figure 52: IAR Embedded Workbench – Options – 1**



**Figure 53: IAR Embedded Workbench – Options – 2**

- 3) Click OK to complete the configuration for WyzBee™.

## 5 Appendix B: WyzBee™ Headers

The WyzBee™ baseboard comes with 2 16-pin THING™ Headers. These headers can be used to add a combination of multiple THING™ boards.

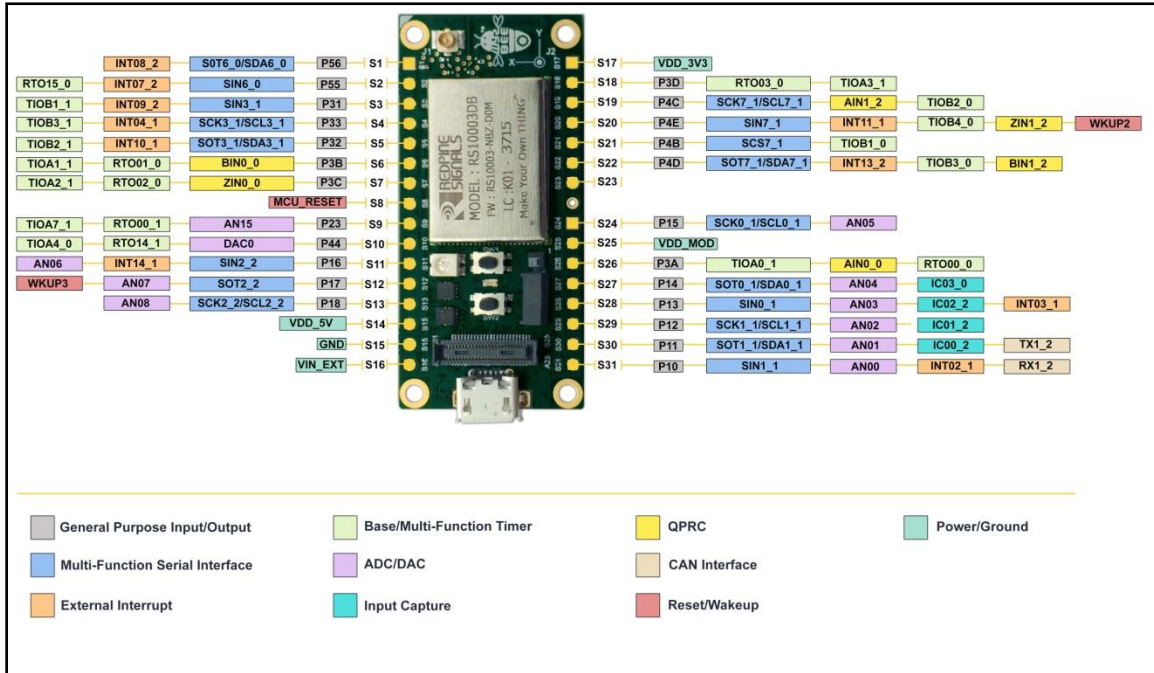


Figure 54: 32-pin WyzBee™ THING Header

### 5.1 Pin Description

The table below describes the pins of the WyzBee™ baseboard's Headers.

Pin Name	Function	Direction	Description
<b>THING Headers</b>			
S1	P56	Inout	General-purpose Input/Output
	SOT6_0/SDA6_0	Output/Inout	Multi-function Serial Interface Channel 6 Output/Inout
	INT08_2	Input	External Interrupt 8
S2	P55	Inout	General-purpose Input/Output
	SIN6_0	Input	Multi-function Serial interface Channel 6 Input
	RTO15_0	Output	Waveform generator output of Multi-function timer 15

Pin Name	Function	Direction	Description
	INT07_2	Input	External Interrupt 7
S3	P31	Inout	General-purpose Input/Output
	TIOB1_1	Inout	Base Timer Channel 1 TIOB pin. This can be used only if S16 is not configured as TIOB1_0.
	SIN3_1	Input	Multi-function Serial interface Channel 3 Input
	INT09_2	Input	External Interrupt 9
S4	P33	Inout	General-purpose Input/Output
	TIOB3_1	Inout	Base Timer Channel 3 TIOB pin. This can be used only if S17 is not configured as TIOB3_0.
	SCK3_1/SCL3_1	Output	Multi-function Serial interface Channel 3 Clock output
	INT04_1	Input	External Interrupt 4
S5	P32	Inout	General-purpose Input/Output
	TIOB2_1	Inout	Base Timer Channel 2 TIOB pin. This can be used only if S14 is not configured as TIOB2_0.
	SOT3_1/SDA3_1	Output/Inout	Multi-function Serial Interface Channel 3 Output/Inout
	INT10_1	Input	External Interrupt 10
S6	P3B	Inout	General-purpose Input/Output
	TIOA1_1	Inout	Base Timer Channel 1 TIOA pin
	BIN0_0	Input	QPRC Channel 0 BIN Input
	RTO01_0	Output	Waveform generator output of Multi-function timer 1
S7	P3C	Inout	General-purpose Input/Output
	TIOA2_1	Inout	Base Timer Channel 2 TIOA pin

Pin Name	Function	Direction	Description
	ZIN0_0	Input	QPRC Channel 0 ZIN Input
	RTO02_0	Output	Waveform generator output of Multi-function timer 2
S8	MCU_RESET_N	Input	External reset
S9	P23	Inout	General-purpose Input/Output
	TIOA7_1	Inout	Base Timer Channel 7 TIOA pin
	RTO00_1	Output	Waveform generator output of Multi-function timer 0
	AN15	Input	ADC Input Channel 15
S10	P44	Inout	General-purpose Input/Output
	TIOA4_0	Inout	Base Timer Channel 4 TIOA pin
	RTO14_1	Output	Waveform generator output of Multi-function timer 14
	DAC0	Output	DAC Output Channel 0
S11	P16	Inout	General-purpose Input/Output
	SIN2_2	Input	Multi-function Serial interface Channel 2 Input
	INT14_1	Input	External Interrupt 14
	AN06	Input	ADC Input Channel 6
S12	P17	Inout	General-purpose Input/Output
	SOT2_2	Output	Multi-function Serial Interface Channel 2 Output
	AN07	Input	ADC Input Channel 7
	WKUP3	Input	Deep standby mode return Channel 3 Input
S13	P18	Inout	General-purpose Input/Output
	SCK2_2/SCL2_2	Output	Multi-function Serial interface

Pin Name	Function	Direction	Description
			Chanel 2 Clock output
	AN08	Input	ADC Input Channel 8
S14	VDD_5V	Output	5V Output Power Supply for THING boards.
S15	GND	Ground	Ground
S16	VIN_EXT	Input	External Power Supply. This can be from different sources like battery THING.
S12	P15	Inout	General-purpose Input/Output
	SCK0_1/SCL0_1	Output	Multi-function Serial interface Chanel 0 Clock output
	AN05	Input	ADC Input Channel 5
S17	VDD_3V3	Output	3.3V Output Power supply
S18	P4C	Inout	General-purpose Input/Output
	TIOB2_0	Inout	Base Timer Channel 2 TIOB pin
	SCK7_1/SCL7_1	Output	Multi-function Serial interface Chanel 7 Clock output
	AIN1_2	Input	QPRC Channel 1 AIN Input
S19	P4E	Inout	General-purpose Input/Output
	TIOB4_0	Inout	Base Timer Channel 4 TIOB pin
	SIN7_1	Input	Multi-function Serial interface Channel 7 Input
	ZIN1_2	Input	QPRC Channel 1 ZIN Input
	INT11_1	Input	External Interrupt 11
	WKUP2	Input	Deep standby mode return Channel 2 Input
S20	P4B	Inout	General-purpose Input/Output



Pin Name	Function	Direction	Description
	TIOB1_0	Inout	Base Timer Channel 1 TIOB pin. This can be used only if S12 is not configured as TIOB1_1.
	SCS7_1	Output	Multi-function Serial interface Channel 7 Chip Select
S21	P4D	Inout	General-purpose Input/Output
	TIOB3_0	Inout	Base Timer Channel 3 TIOB pin. This can be used only if S3 is not configured as TIOB3_0.
	SOT7_1/SDA7_1	Output/Inout	Multi-function Serial Interface Channel 2 Output/Inout
	BIN1_2	Input	QPRC Channel 1 BIN Input
	INT13_2	Input	External Interrupt 13
S22	Ground	Ground	Ground
S23	MCU_VCC33	Output	3.3V Power Supply
S24	P3D	Inout	General-purpose Input/Output
	TIOA3_1	Inout	Base Timer Channel 3 TIOA pin
	RTO03_0	Output	Waveform generator output of Multi-function timer 3
S25	VDD_MOD	Output	3.3V Output Power supply
S26	P3A	Inout	General-purpose Input/Output
	TIOA0_1	Inout	Base Timer Channel 0 TIOA pin
	AIN0_0	Input	QPRC Channel 0 AIN Input
	RTO00_0	Inout	Waveform generator output of Multi-function timer 0
S27	P14	Inout	General-purpose Input/Output
	SOT0_1/SDA0_1	Output/Inout	Multi-function Serial Interface Channel 0 Output/Inout

Pin Name	Function	Direction	Description
	IC03_2	Input	16-bit input capture Channel 3 input pin of Multi-function timer 0
	AN04	Input	ADC Input Channel 4
S28	P13	Inout	General-purpose Input/Output
	SIN0_1	Input	Multi-function Serial interface Channel 0 Input
	IC02_2	Input	16-bit input capture Channel 2 input pin of Multi-function timer 0
	INT03_1		External Interrupt 3
	AN03	Input	ADC Input Channel 3
S29	P12	Inout	General-purpose Input/Output
	SCK1_1/SCL1_1	Output	Multi-function Serial interface Channel 1 Clock output
	IC01_2	Input	16-bit input capture Channel 1 input pin of Multi-function timer 0
	RTCC0_1	Output	Reserved
	AN02	Input	ADC Input Channel 2
S30	P11	Inout	General-purpose Input/Output
	TX1_2	Output	CAN interface Channel 1 TX output
	SOT1_1/SDA1_1	Output/Inout	Multi-function Serial Interface Channel 1 Output/Inout
	IC00_2	Input	16-bit input capture Channel 0 input pin of Multi-function timer 0
	AN01	Input	ADC Input Channel 1

Pin Name	Function	Direction	Description
S31	P10	Inout	General-purpose Input/Output
	INT02_1	Input	External Interrupt 2
	RX1_2	Output	CAN interface Channel 1 RX input
	SIN1_1	Input	Multi-function Serial interface Channel 1 Input
	AN00	Input	ADC Input Channel 0

**Table 2: Headers Pins Description**

\*\*\*\*\*