

47 μ F AC-Coupling Capacitor 4in-2out Video Driver with Isolation Amplifier

■GENERAL DESCRIPTION

NJW1342 is 47 μ F AC-Coupling Capacitor 4in-2out Video Driver with Isolation Amplifier. It can remove common mode noise because internal Isolation amplifier. It can reduce (47 μ F) usual output capacitor by NJRC original "ASC(Advanced SAG Correction)", and contributes to space saving.

NJW1342 is the best for the switch of the video signal of car AV.

■PACKAGE OUTLINE

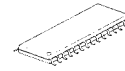

NJW1342V

■FEATURES

- Operating Voltage 3.0 to 6.0V
- Small output coupling capacitor 47 μ F
- Internal Isolation Amplifier
- 4-input 2-output selector
- Internal 6dB Amplifier, 75ohm Driver
- I2C Bus Interface
- Bi-CMOS Technology
- Package Outline SSOP32

■BLOCK DIAGRAM

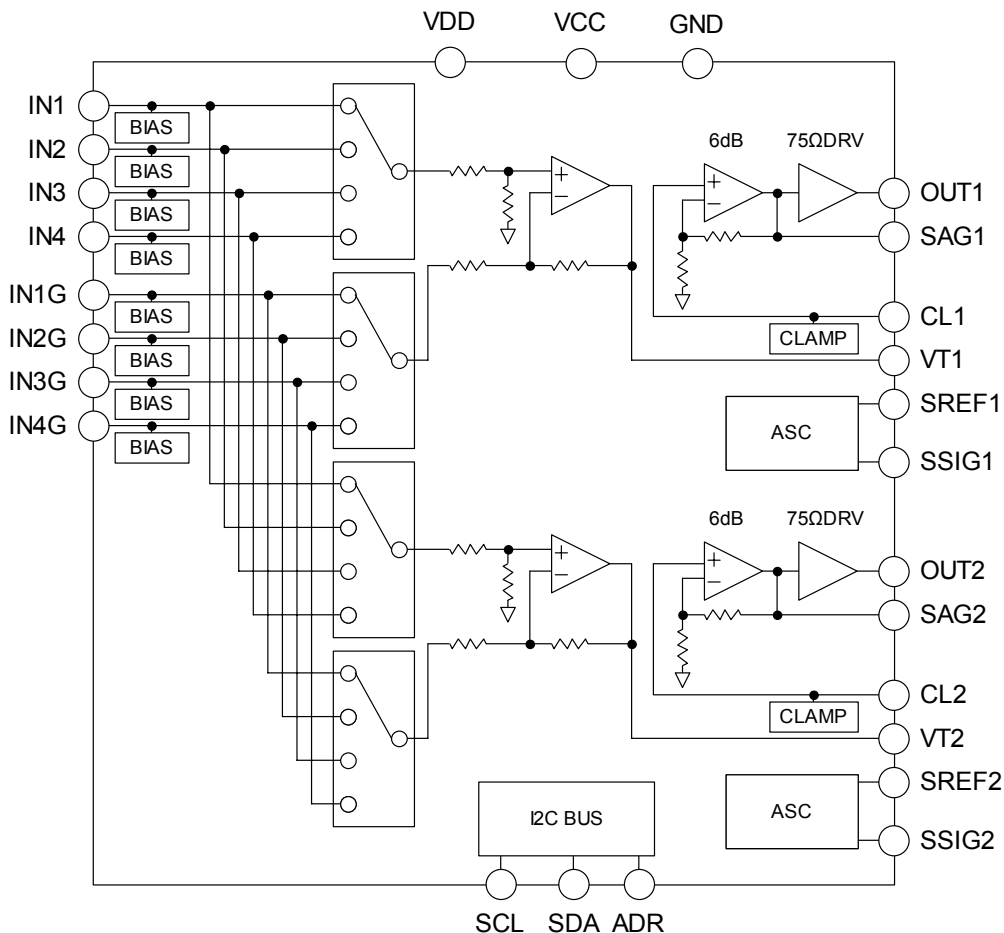

■PIN CONFIGURATION

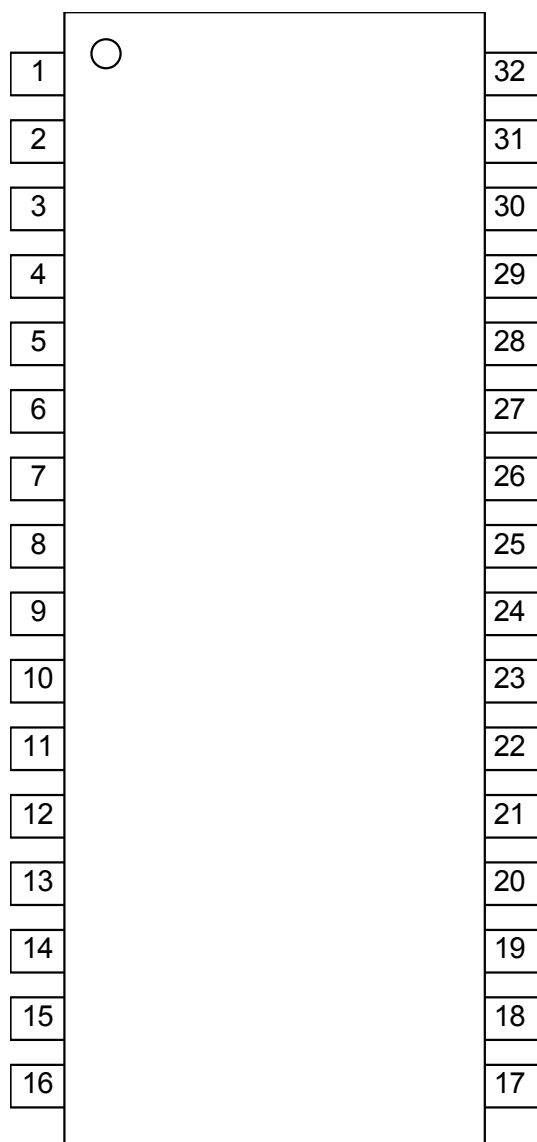

- | | |
|----------|-----------|
| 1. VCC | 17. SDA |
| 2. IN1 | 18. SCL |
| 3. IN1G | 19. SREF2 |
| 4. GND | 20. SSIG2 |
| 5. IN2 | 21. SAG2 |
| 6. IN2G | 22. OUT2 |
| 7. NC | 23. CL2 |
| 8. IN3 | 24. VT2 |
| 9. IN3G | 25. VCC |
| 10. VCC | 26. GND |
| 11. IN4 | 27. VT1 |
| 12. IN4G | 28. CL1 |
| 13. NC | 29. OUT1 |
| 14. VDD | 30. SAG1 |
| 15. ADR | 31. SSIG1 |
| 16. GND | 32. SREF1 |

■ABSOLUTE MAXIMUM RATINGS (Ta=25°C)

PARAMETER	SYMBOL	RATINGS	UNIT
Supply Voltage	V^+	7.0	V
Power Dissipation	P_D	1100(note1)	mW
Operating Temperature Range	T_{opr}	-40 to +85	°C
Storage Temperature Range	T_{stg}	-40 to +150	°C

(Note1) At on a board of EIA/JEDEC specification. (114.3 x 76.2 x 1.6mm Two layers, FR-4)

■RECCOMENDED OPERATING CONDITIONS (Ta=25°C)

PARAMETER	SYMBOL	TEST CONDITION	MIN.	TYP.	MAX.	UNIT
Operating voltage	V_{opr}		3.0	-	5.5	V

■ELECTRICAL CHARACTERISTICS(VCC,VDD=5V, RL=150ohm,Ta=25°C)

PARAMETER	SYMBOL	TEST CONDITION	MIN.	TYP.	MAX.	UNIT
Supply Current	I_{cc1}	No signal	-	60	100	mA
Supply Current	I_{cc2}	OUT1:active, OUT2:power save	-	30	60	mA
Supply Current	I_{cc3}	OUT1:power save, OUT2:active	-	30	60	mA
Supply Current	I_{cc4}	VDD	-	0.5	1	mA
Supply Current at Power Save Mode	I_{save}	Power save mode	-	2	4	mA
Maximum Output Level	V_{om}	$V_{in}=100kHz, sin\text{-}signal, THD=1\%$,	2.0	2.2	-	Vp-p
Voltage Gain	G_v	$V_{in}=1MHz, 1.0Vp\text{-}p sin\text{-}signal$	5.5	6.0	6.5	dB
Frequency Characteristic	G_f	$V_{in}=10MHz / 1MHz, 1.0Vpp sin\text{-}signal$	-1.0	0	1.0	dB
Common Mode Noise Ratio	CMR	$V_{in}=20KHz, V_{in}=1Vpp$	-	-55	-	dB
Cross-talk	CT-1	$V_{in}=4.43MHz, 1.0Vp\text{-}p sin\text{-}signal$	-	-60	-	dB
Differential Gain	DG	$V_{in}=1.0Vp\text{-}p 10step video\text{-}signal$	-	0.5	-	%
Differential Phase	DP	$V_{in}=1.0Vp\text{-}p 10step video\text{-}signal$	-	0.5	-	deg

■PORT

PARAMETER	SYMBOL	TEST CONDITION	MIN.	TYP.	MAX.	UNIT
ADR Input Voltage High Level	V_{ADRH}		2.2		V_{cc}	
ADR Input Voltage Low Level	V_{ADRL}		0	-	1.0	V

■TIMING on the I²C BUS (SDA, SCL)

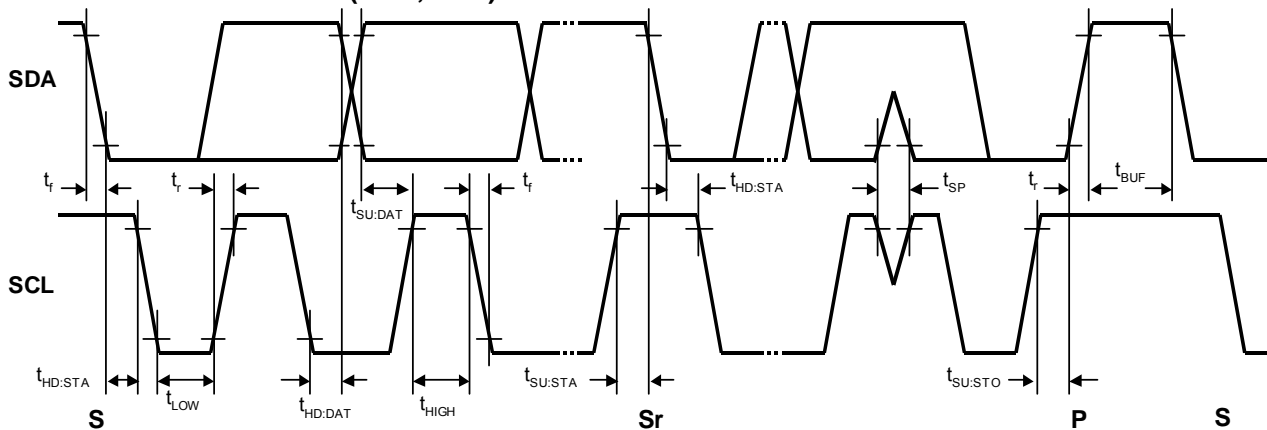

■CHARACTERISTICS OF BUS LINES (SDA, SCL) FOR I²C BUS DEVICES

I²C BUS Load Conditions

STANDARD MODE : Pull up resistance 4k Ω (Connected to +3.3V), Load capacitance 200pF (Connected to GND)

FAST MODE : Pull up resistance 4k Ω (Connected to +3.3V), Load capacitance 50pF (Connected to GND)

PARAMETER	SYM BOL	Standard mode			Fast mode			UNI T
		MIN.	TYP.	MAX.	MIN.	TYP.	MAX.	
Low Level Input Voltage	V _{IL}	0.0	-	1.2	0.0	-	1.2	V
High Level Input Voltage	V _{IH}	2.4	-	5.0	2.4	-	5.0	V
Hysteresis of Schmitt Trigger Inputs	V _{hys}	-	-	-	0.25	-	-	V
Low level Output Voltage (3mA at SDA pin)	V _{OL}	0	-	0.4	0	-	0.4	V
Output Fall Time From V _{IHmin} to V _{ILmax} with a Bus Capacitance from 10pF to 400pF	t _{of}	-	-	250	20 +0.1C _b	-	250	ns
Pulse width of spikes which must be suppressed by the input filter	t _{SP}	-	-	-	0	-	50	ns
Input Current each I/O pin with an Input Voltage between 0.1 and 0.9V _{DDmax}	I _i	-10	-	10	-10	-	10	μ A
Capacitance for each I/O pin	C _i	-	-	10	-	-	10	pF
SCL Clock Frequency	f _{SCL}	-	-	100	-	-	400	kHz
Data Transfer Start Minimum Waiting Time	t _{HD:STA}	4.0	-	-	0.6	-	-	μ s
Low Level Clock Pulse Width	t _{LOW}	4.7	-	-	1.3	-	-	μ s
High Level Clock Pulse Width	t _{HIGH}	4.0	-	-	0.6	-	-	μ s
Minimum Start Preparation Waiting Time	t _{SU:STA}	4.7	-	-	0.6	-	-	μ s
Minimum Data Hold Time ^(NOTE)	t _{HD:DAT}	0.0	-	-	0.0	-	-	μ s
Minimum Data Preparation Time	t _{SU:DAT}	250	-	-	100	-	-	ns
Rise Time	t _r	-	-	1000	-	-	300	ns
Fall Time	t _f	-	-	300	-	-	300	ns
Minimum Stop Preparation Waiting Time	t _{SU:STO}	4.0	-	-	0.6	-	-	μ s
Data Change Minimum Waiting Time	t _{BUF}	4.7	-	-	1.3	-	-	μ s
Capacitive load for each bus line	C _b	-	-	400	-	-	400	pF
Noise Margin at the Low Level	V _{nL}	0.5	-	-	0.5	-	-	V
Noise Margin at the High Level	V _{nH}	1	-	-	1	-	-	V

C_b ; total capacitance of one bus line in pF.

(NOTE). Please hold the Data Hold Time (t_{HD:DAT}) to 300ns or more to avoid status of unstable at SCL falling edge.

■ DEFINITION OF I²C REGISTER

◆ I²C BUS FORMAT

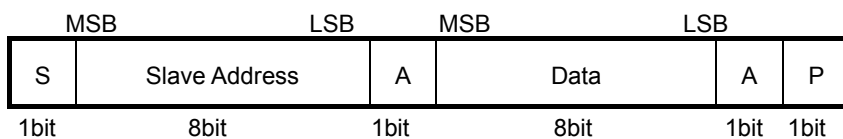

S: Starting Term

A: Acknowledge Bit

P: Ending Term

◆ SLAVE ADDRESS



R/W=0: Receive Only

R/W=1: Data is not transmitted.

ADR : Set the Slave Address by "ADR" terminal.

◆ CONTROL REGISTER DEFAULT VALUE

Control register default values are as follows :

	BIT							
	D7	D6	D5	D4	D3	D2	D1	D0
Data	0	0	0	0	0	0	0	0

◆ INSTRUCTION CODE

	BIT							
	D7	D6	D5	D4	D3	D2	D1	D0
Data	OUT1 MUTE	OUT1 Select		NOT USE:0	OUT2 MUTE	OUT2 Select		NOT USE:0

◆ MUTE TABLE

MUTE	OUT1
D7	
0	MUTE OFF
1	MUTE ON

MUTE	OUT2
D3	
0	MUTE OFF
1	MUTE ON

MUTE OFF: Active mode

MUTE ON: Power save mode

◆VOUT SELECT TABLE

OUT1 Select			OUT1
D6	D5	D4	
0	0	0	VIN1
0	1	0	VIN2
1	0	0	VIN3
1	1	0	VIN4

OUT2Select			OUT2
D2	D1	D0	
0	0	0	VIN1
0	1	0	VIN2
1	0	0	VIN3
1	1	0	VIN4

TEST CIRCUIT

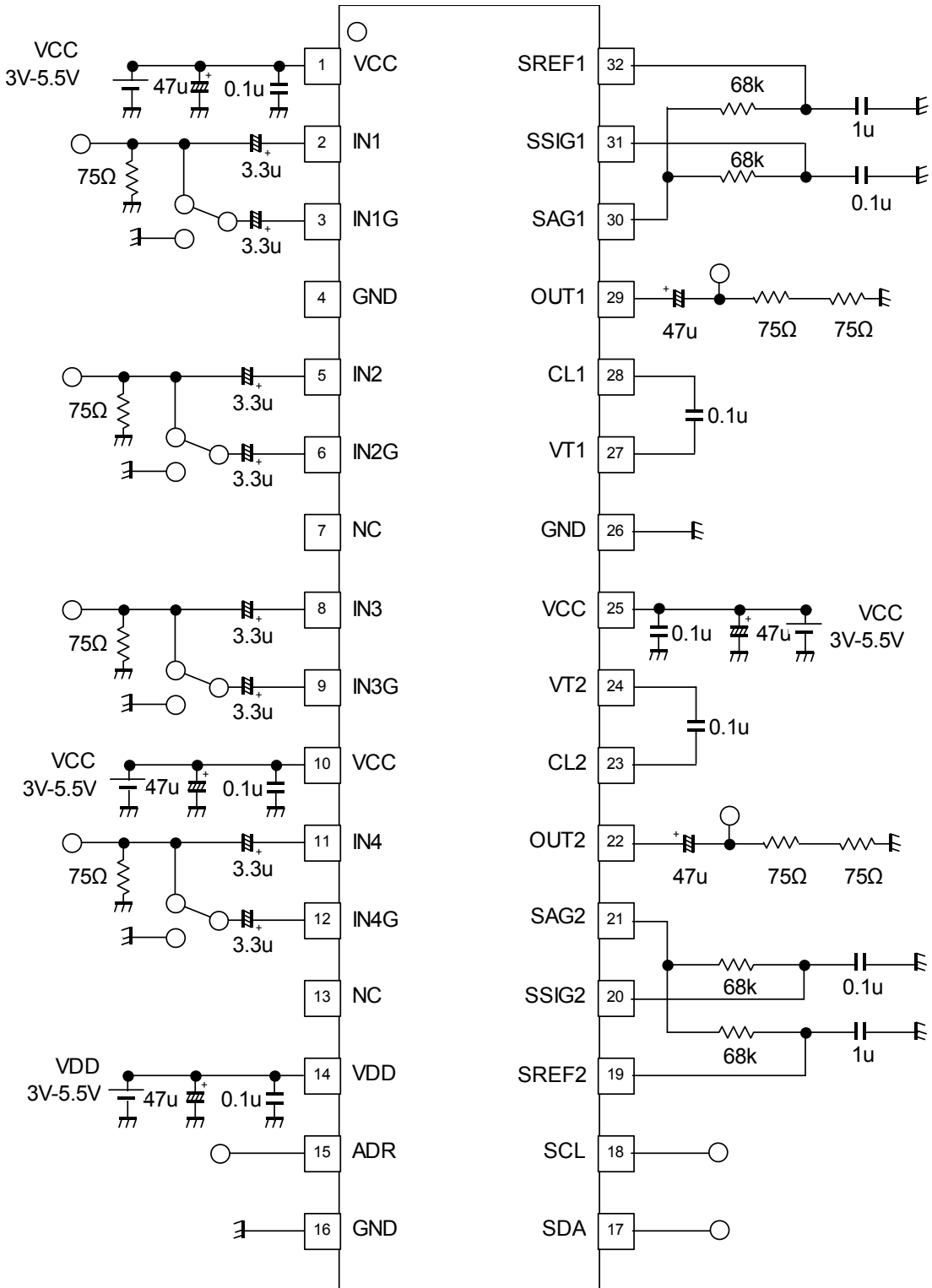

TYPICAL CHARACTERISTICS

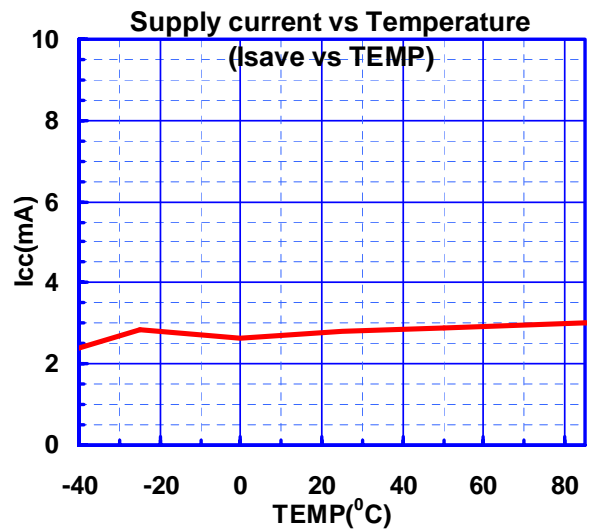
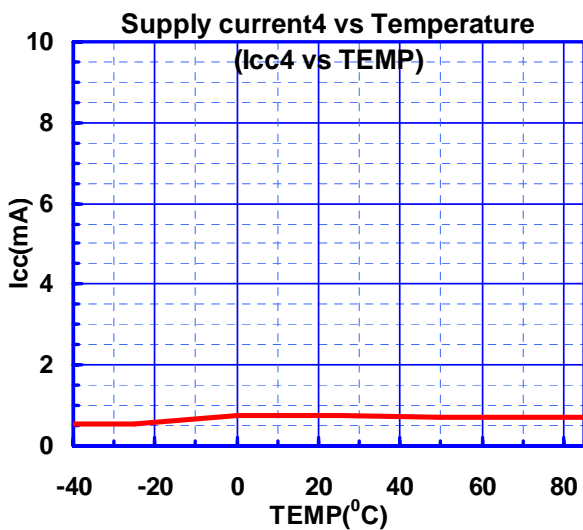
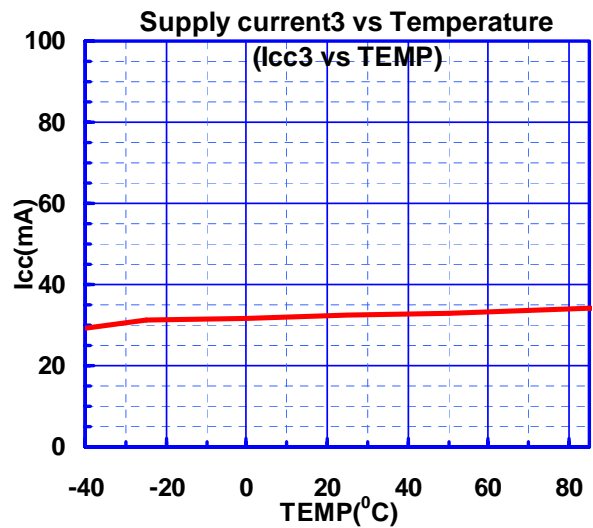
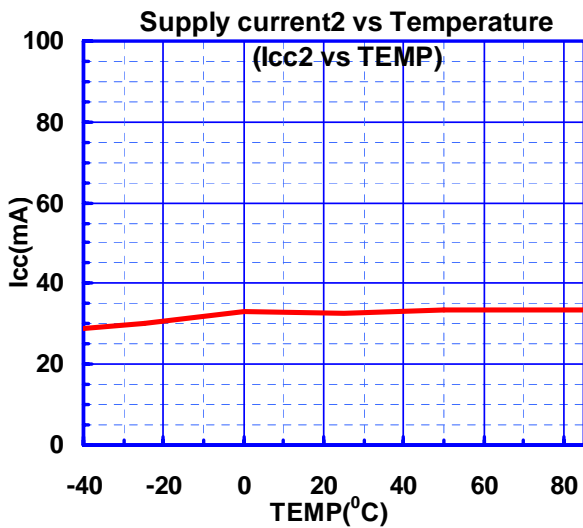
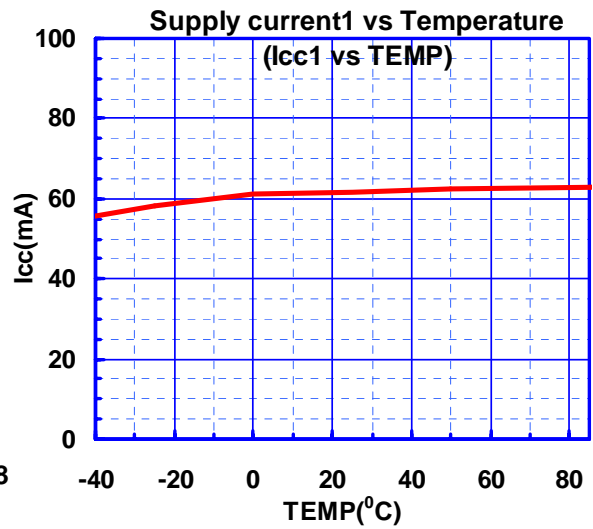
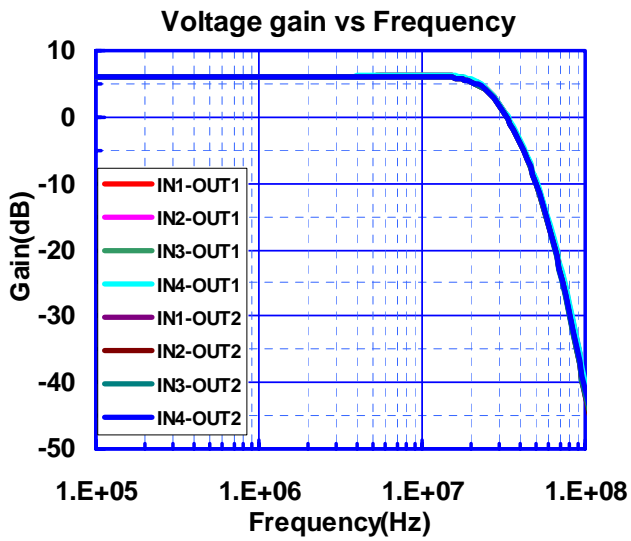

■ TYPICAL CHARACTERISTICS

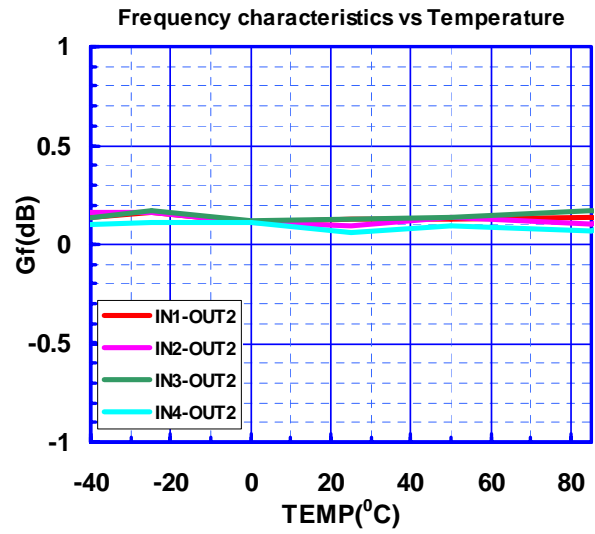
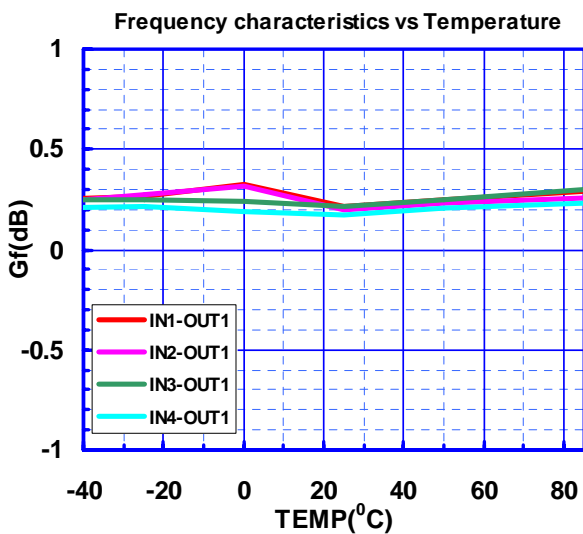
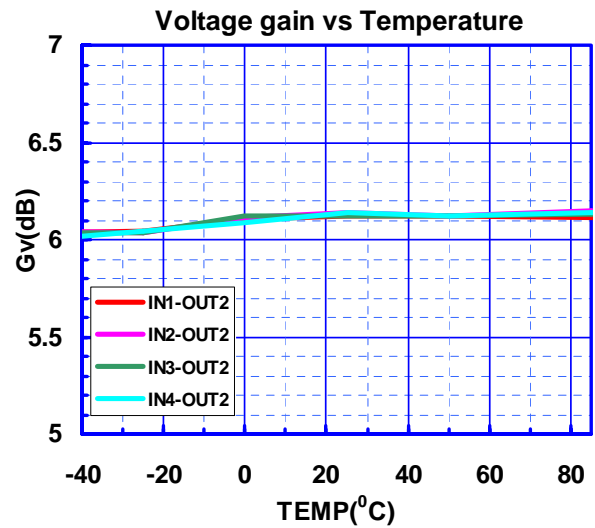
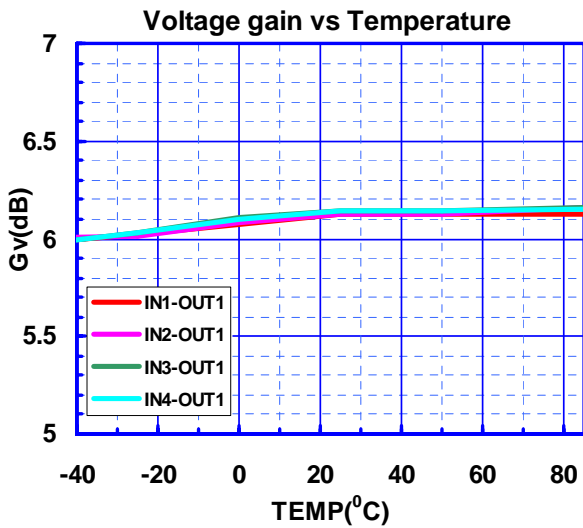
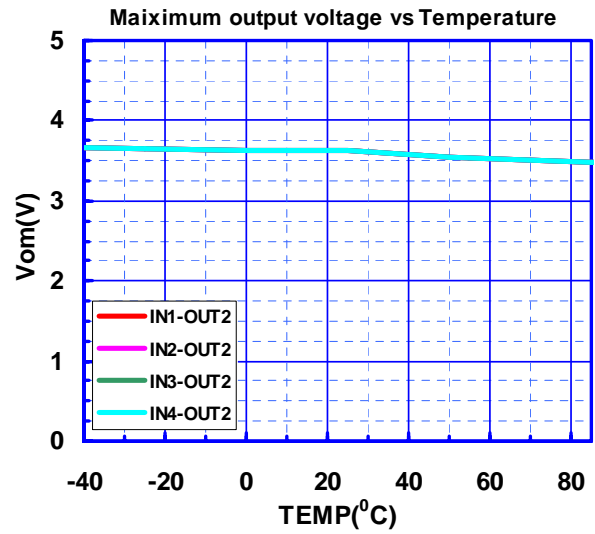
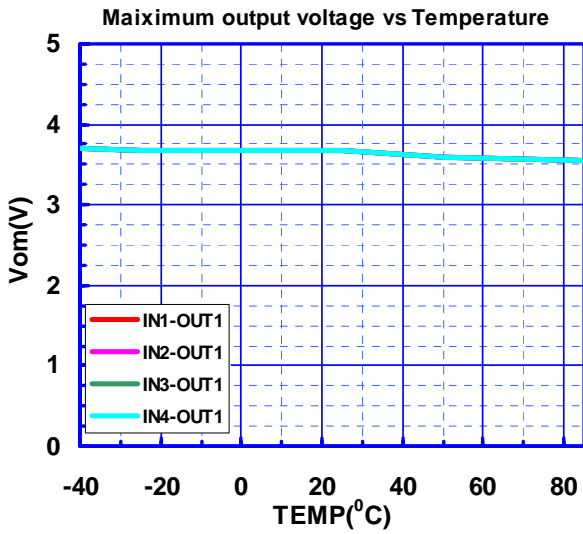

TYPICAL CHARACTERISTICS

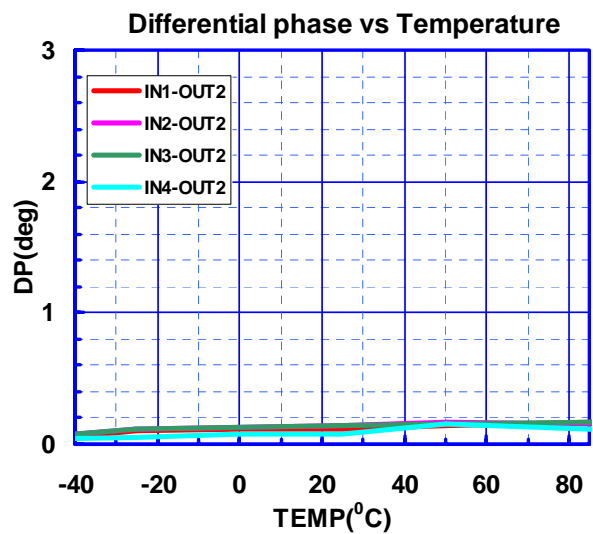
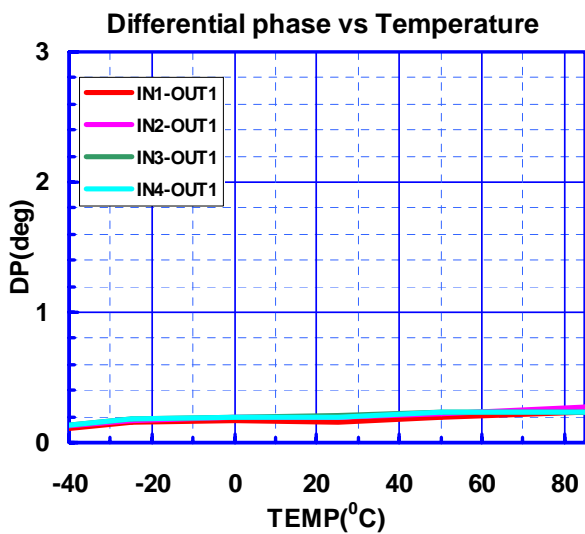
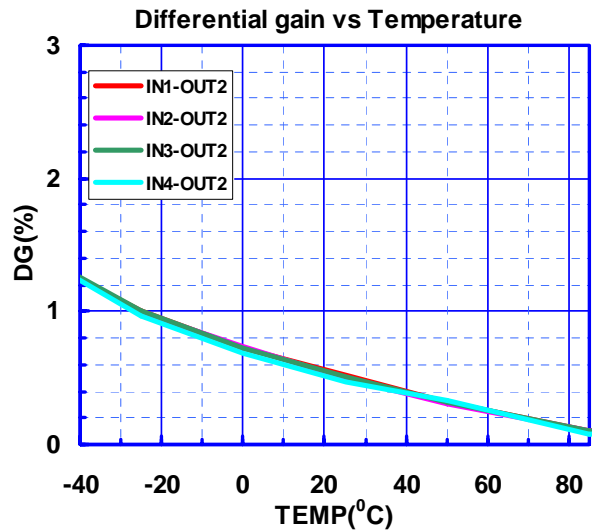
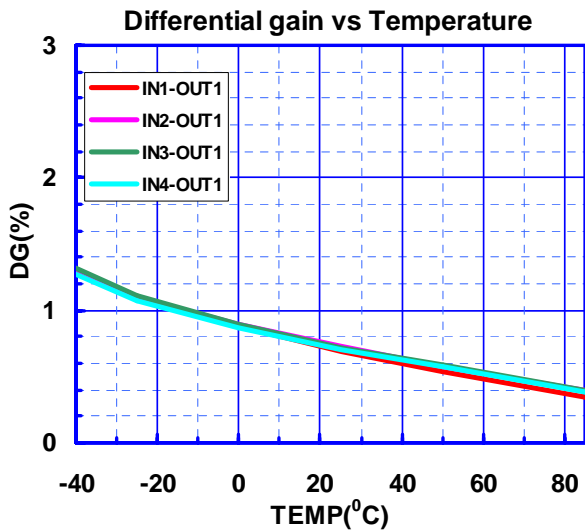
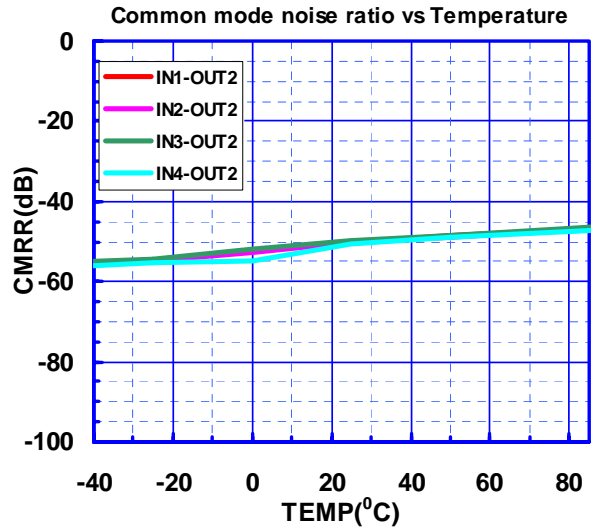
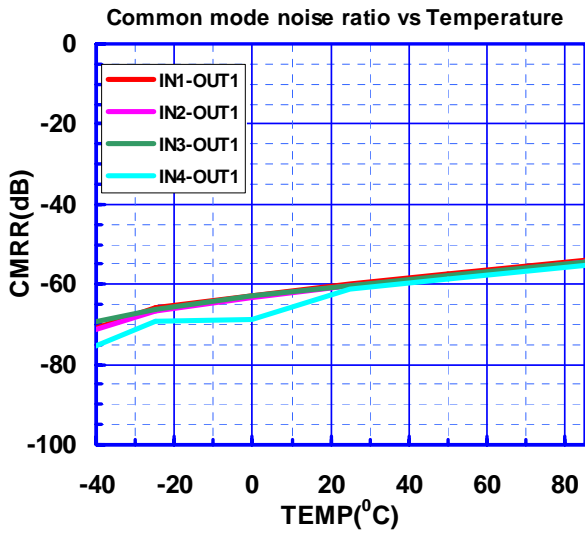

■ TYPICAL CHARACTERISTICS

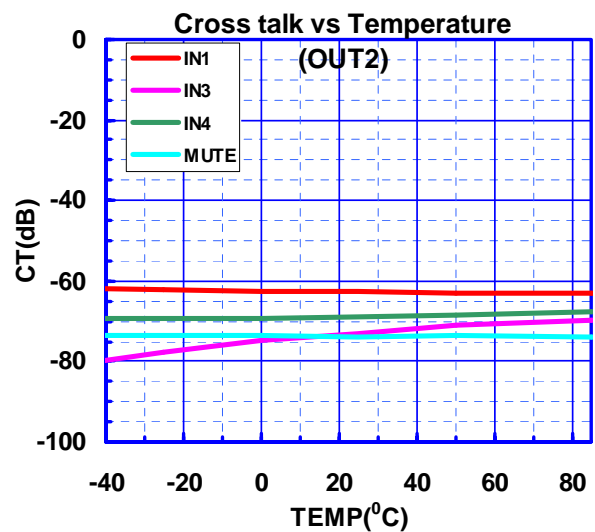
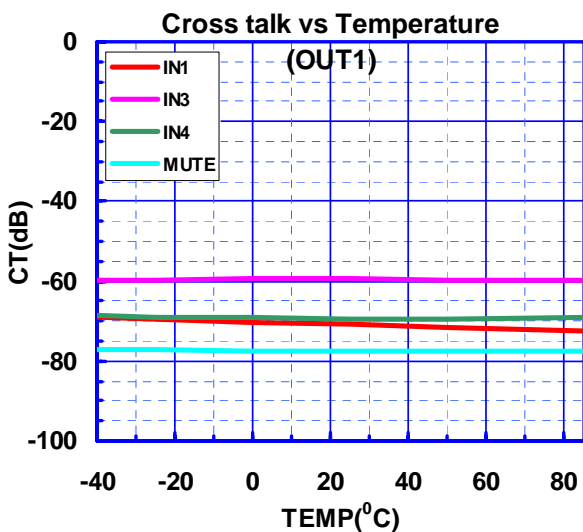
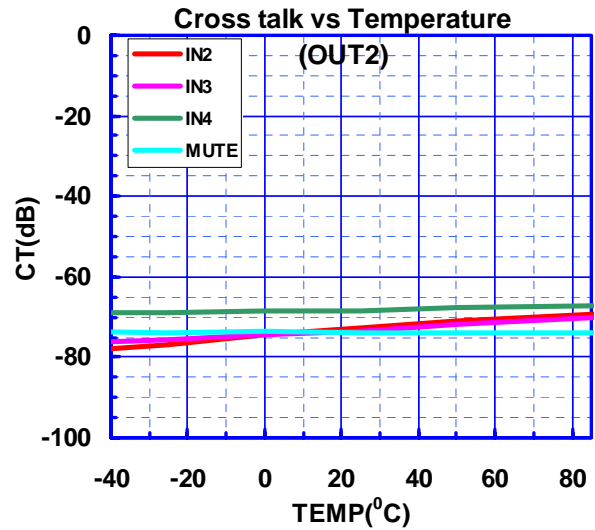
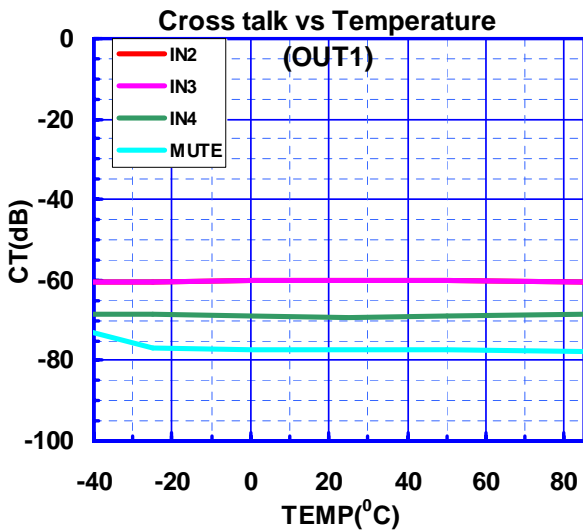
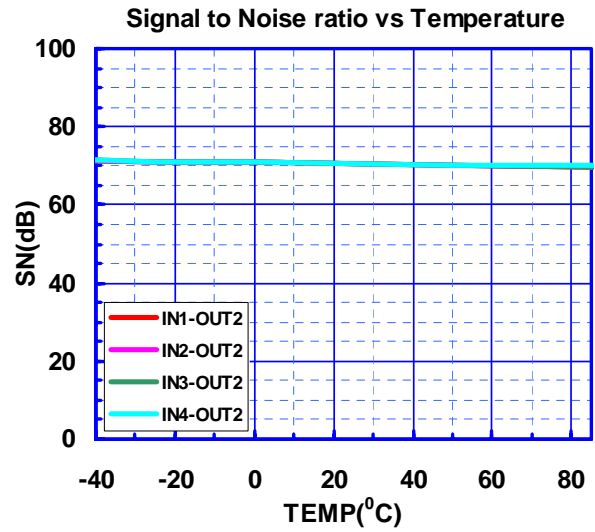
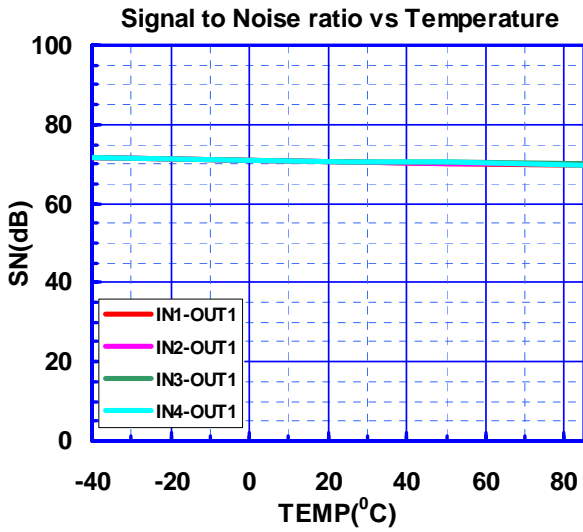

TYPICAL CHARACTERISTICS

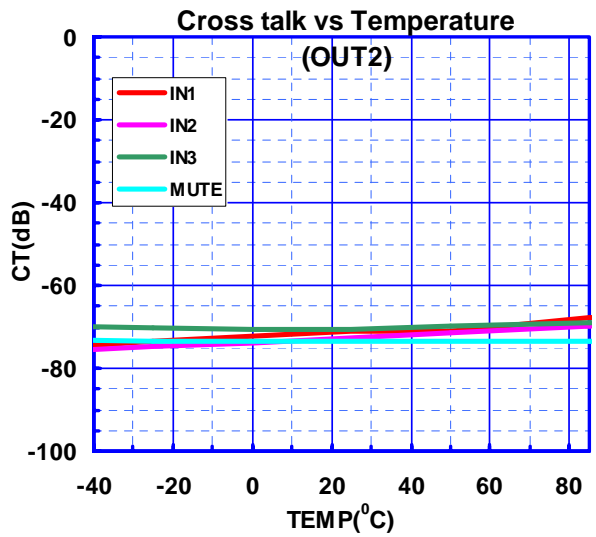
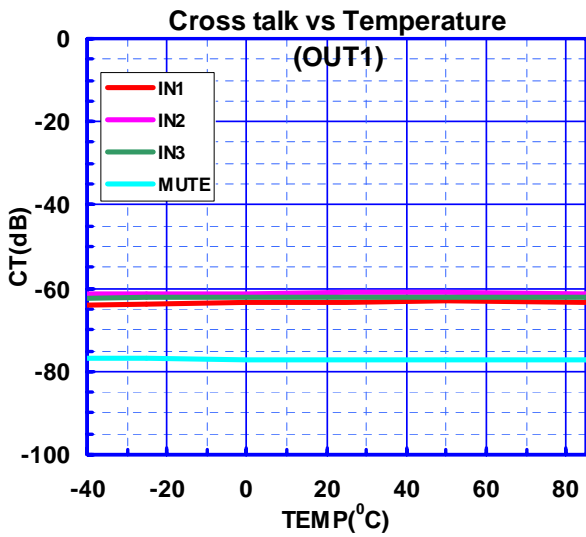
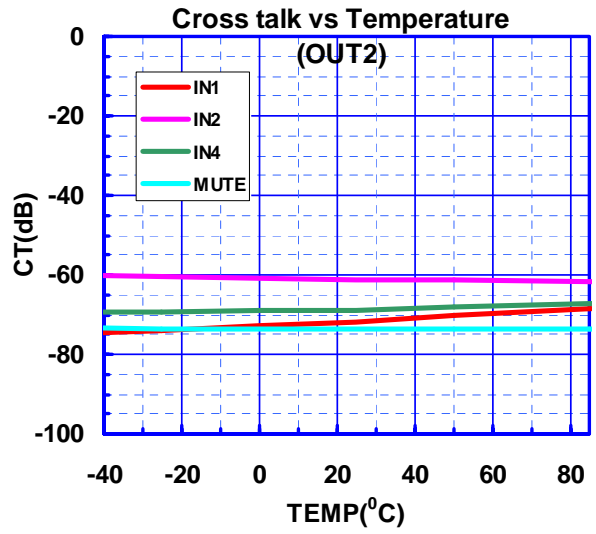
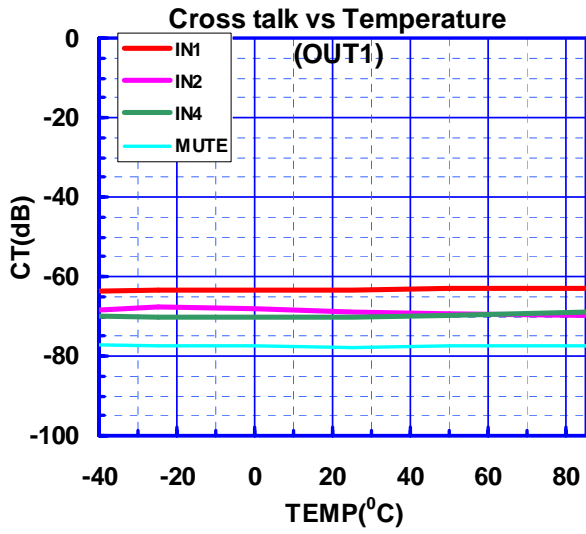

TYPICAL CHARACTERISTICS

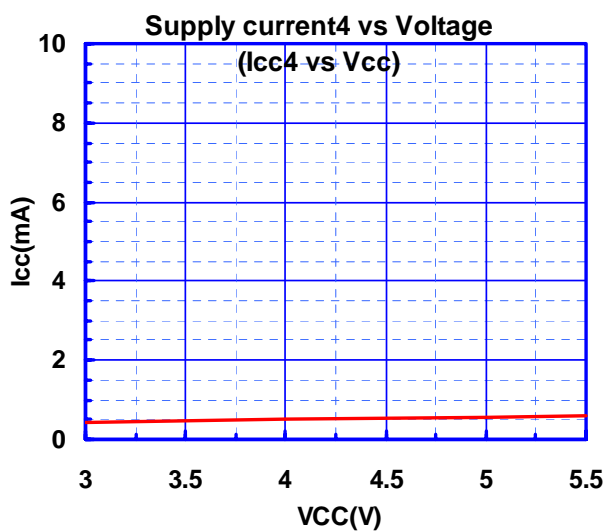
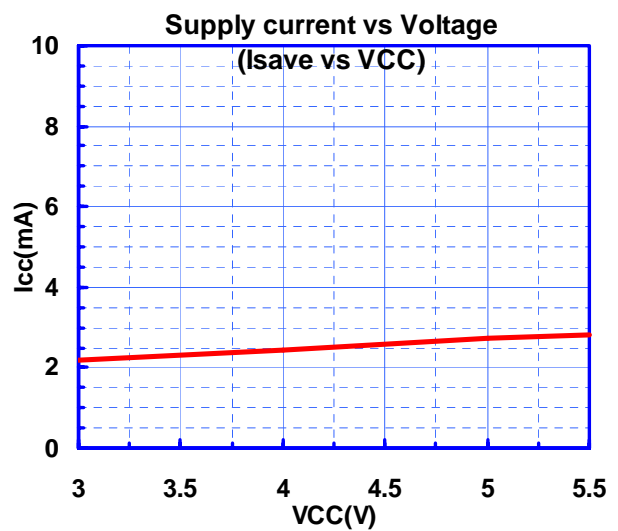
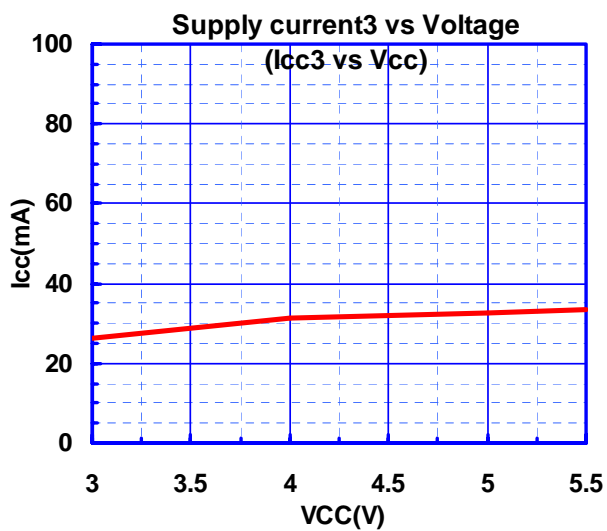
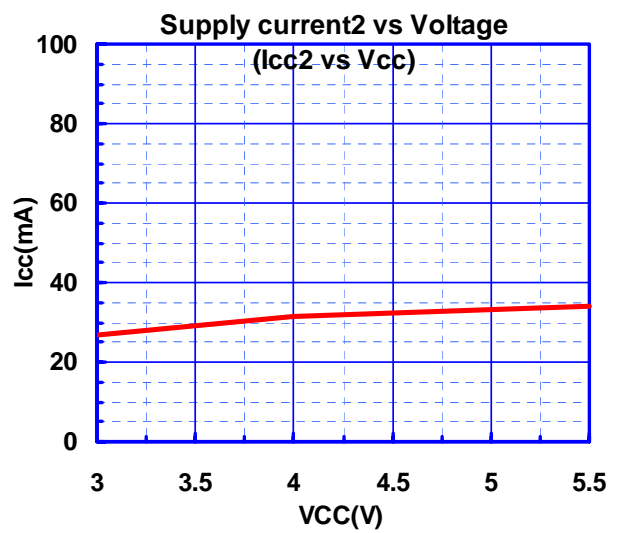
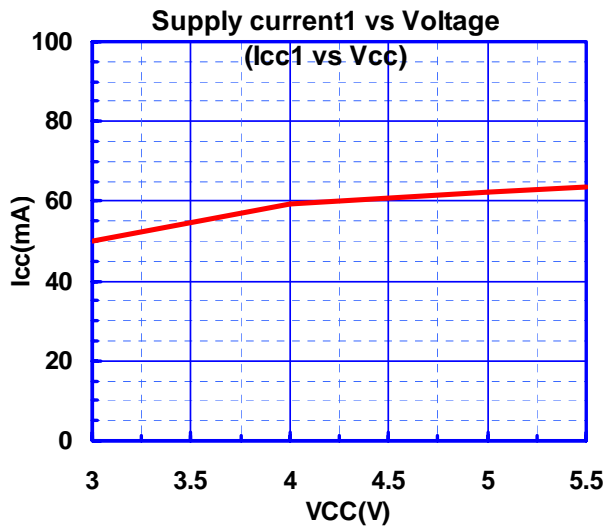

TYPICAL CHARACTERISTICS

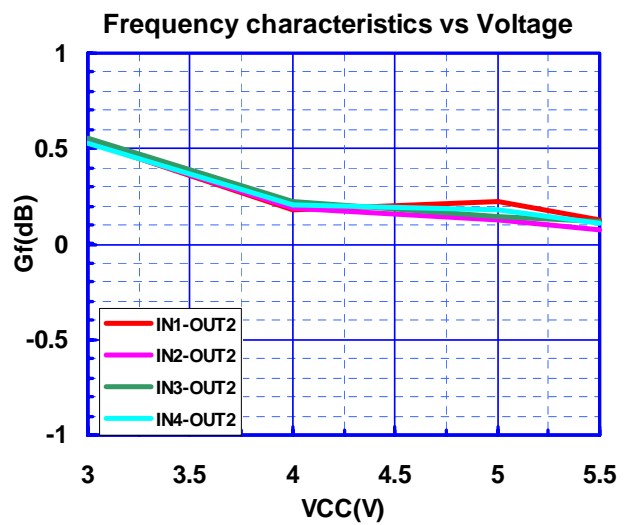
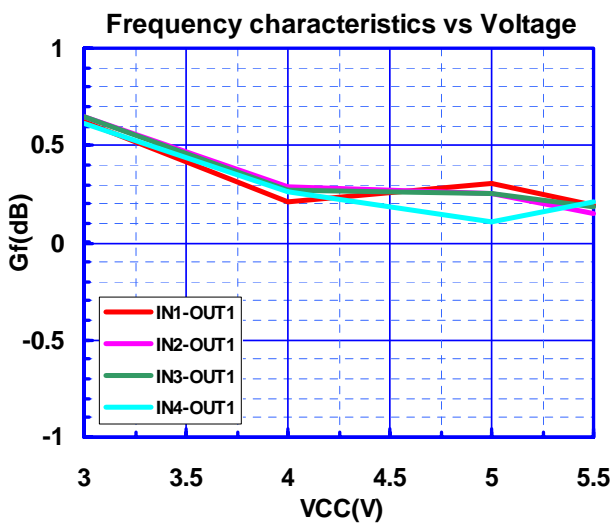
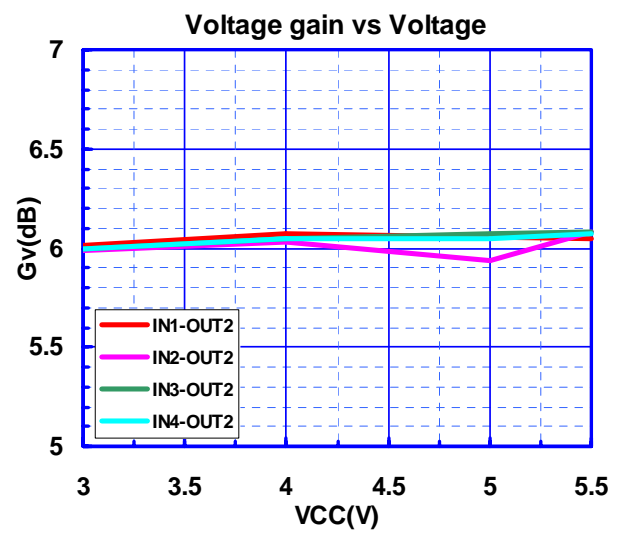
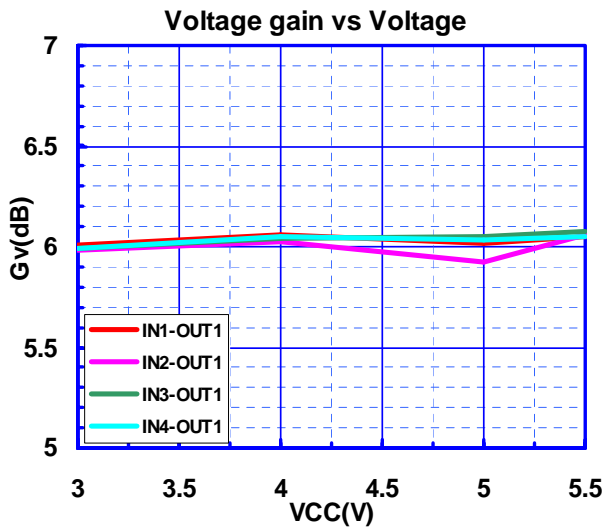
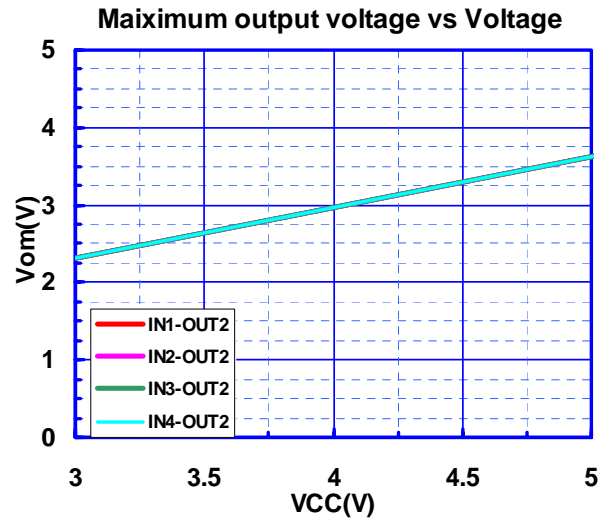
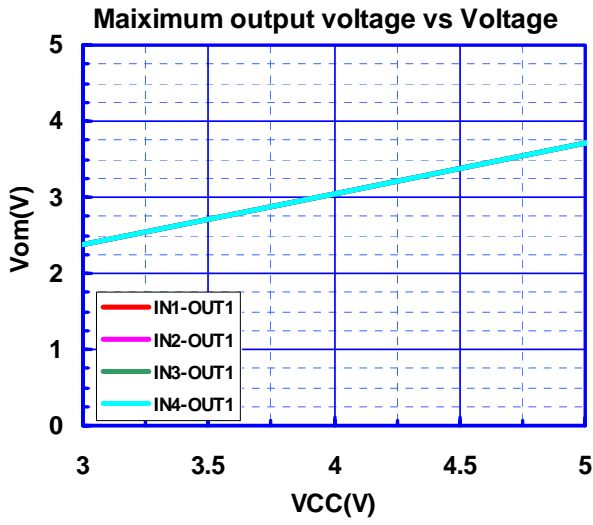

TYPICAL CHARACTERISTICS

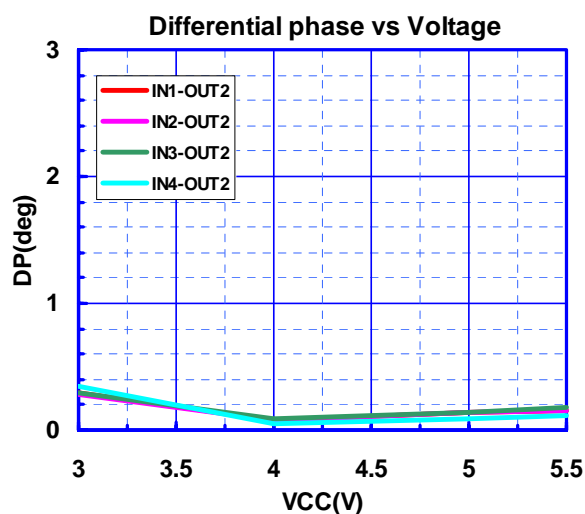
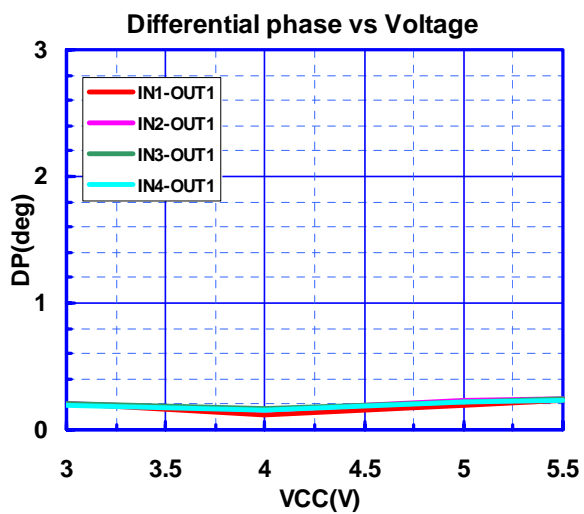
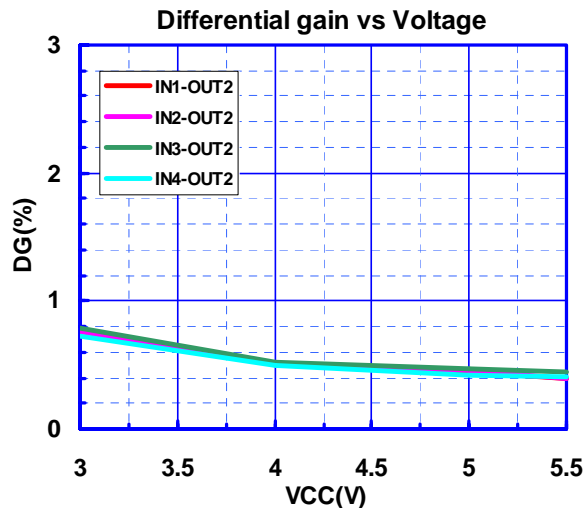
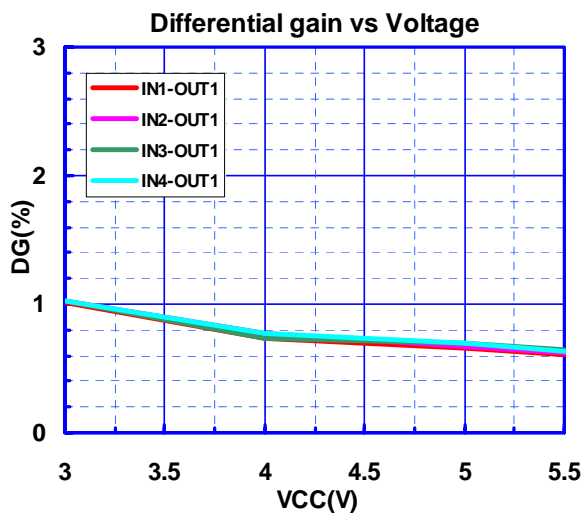
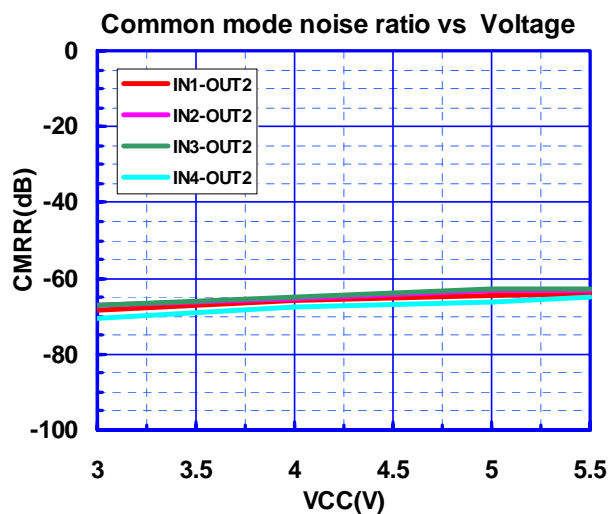
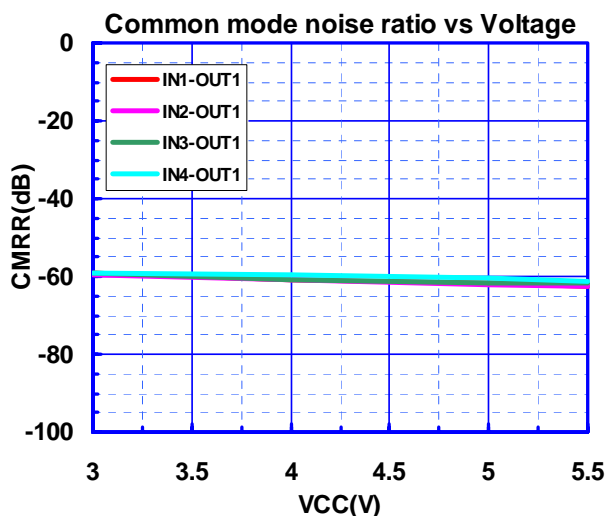

TYPICAL CHARACTERISTICS

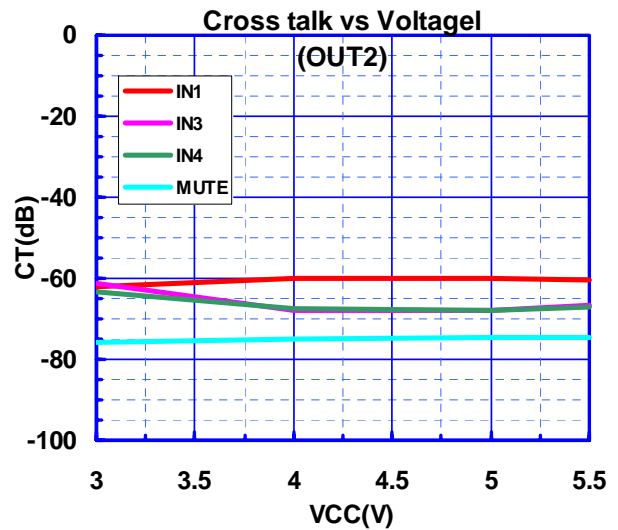
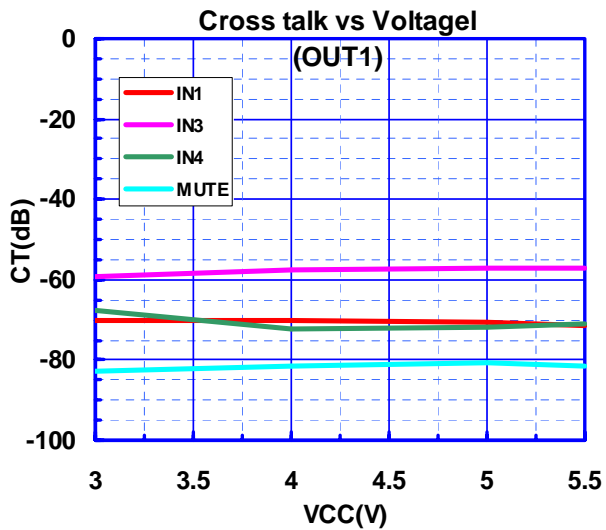
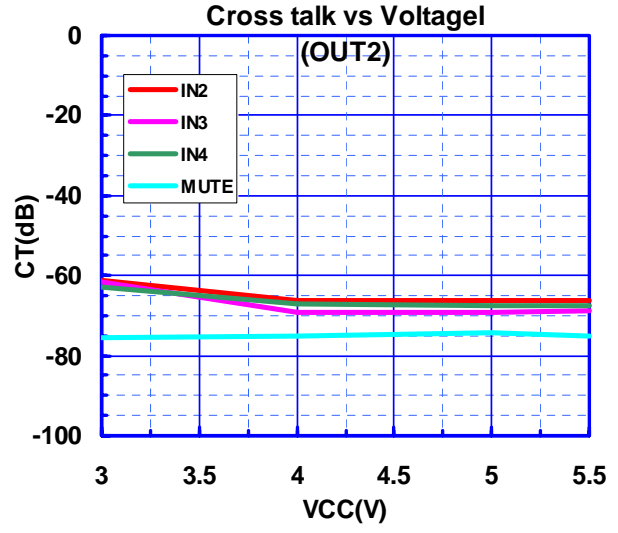
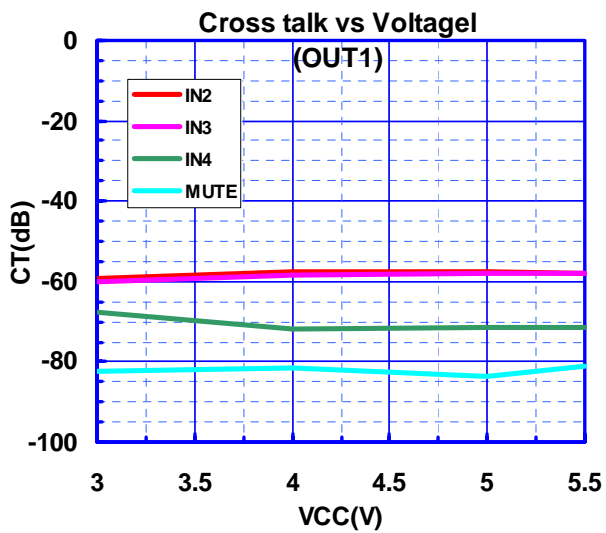
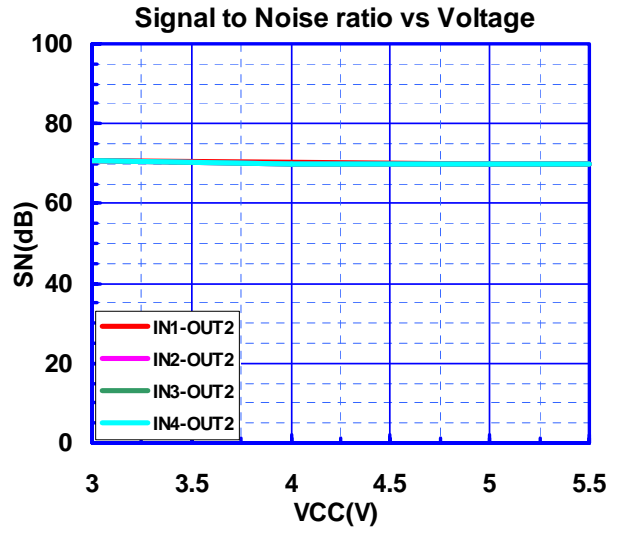
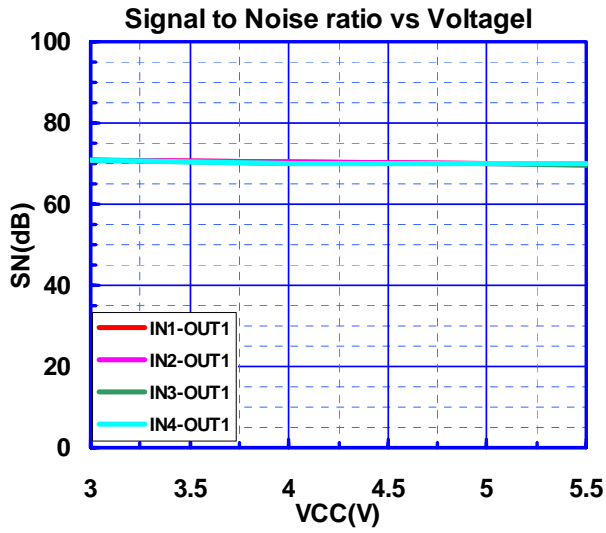

TYPICAL CHARACTERISTICS

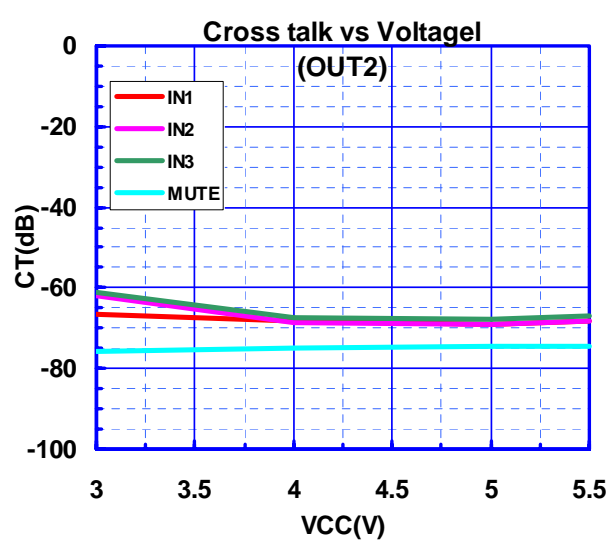
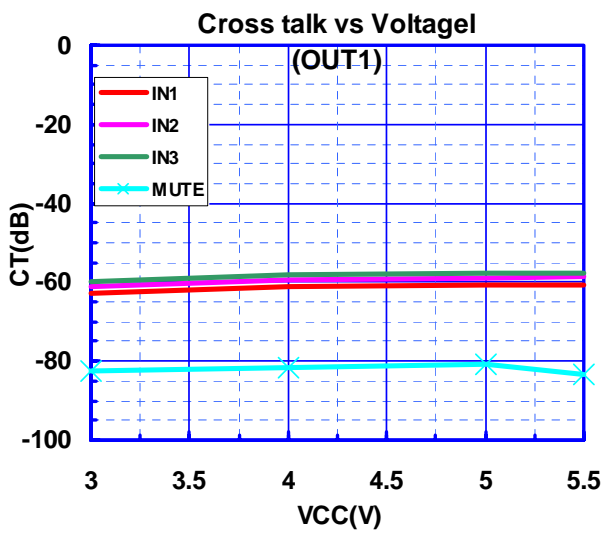
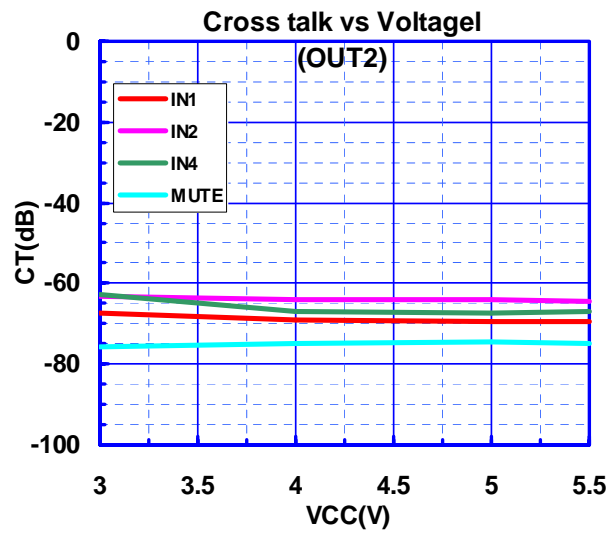
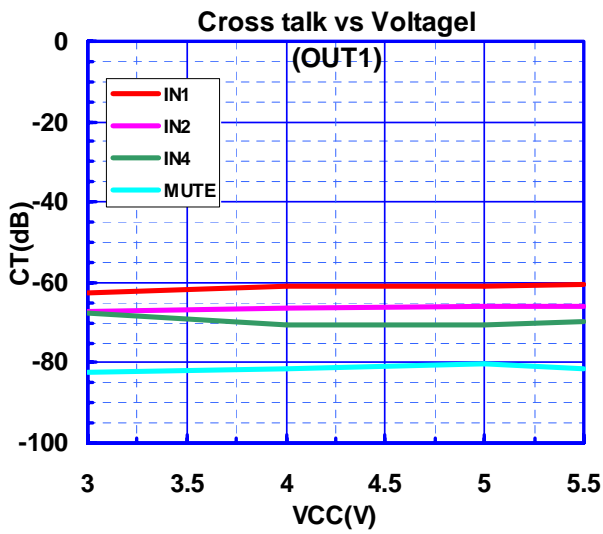

[CAUTION]
 The specifications on this databook are only given for information, without any guarantee as regards either mistakes or omissions. The application circuits in this databook are described only to show representative usages of the product and not intended for the guarantee or permission of any right.

Mouser Electronics

Authorized Distributor

Click to View Pricing, Inventory, Delivery & Lifecycle Information:

[NJR:](#)

[NJW1342V-TE2](#)