

Low  $V_{CE(sat)}$   
High speed IGBT

IXGH/IXGM 25 N100  
IXGH/IXGM 25 N100A

$V_{CES}$	$I_{C25}$	$V_{CE(sat)}$
1000 V	50 A	3.5 V
1000 V	50 A	4.0 V

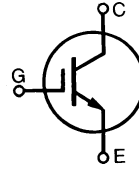

Symbol	Test Conditions	Maximum Ratings	
$V_{CES}$	$T_J = 25^\circ\text{C}$ to $150^\circ\text{C}$	1000	V
$V_{CGR}$	$T_J = 25^\circ\text{C}$ to $150^\circ\text{C}$ ; $R_{GE} = 1\text{ M}\Omega$	1000	V
$V_{GES}$	Continuous	$\pm 20$	V
$V_{GEM}$	Transient	$\pm 30$	V
$I_{C25}$	$T_C = 25^\circ\text{C}$	50	A
$I_{C90}$	$T_C = 90^\circ\text{C}$	25	A
$I_{CM}$	$T_C = 25^\circ\text{C}$ , 1 ms	100	A
<b>SSOA</b> <b>(RBSOA)</b>	$V_{GE} = 15\text{ V}$ , $T_{VJ} = 125^\circ\text{C}$ , $R_G = 33\ \Omega$ Clamped inductive load, $L = 100\ \mu\text{H}$	$I_{CM} = 50$ @ $0.8\ V_{CES}$	A
$P_c$	$T_C = 25^\circ\text{C}$	200	W
$T_J$		-55 ... +150	$^\circ\text{C}$
$T_{JM}$		150	$^\circ\text{C}$
$T_{stg}$		-55 ... +150	$^\circ\text{C}$
$M_d$	Mounting torque (M3)	1.13/10	Nm/lb.in.
<b>Weight</b>		TO-204 = 18 g, TO-247 = 6 g	
	Maximum lead temperature for soldering 1.6 mm (0.062 in.) from case for 10 s	300	$^\circ\text{C}$

TO-247 AD (IXGH)

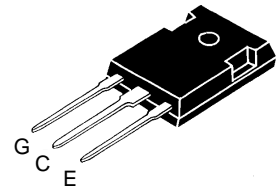

TO-204 AE (IXGM)

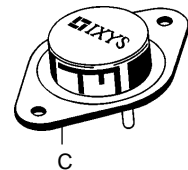

G = Gate, C = Collector,  
E = Emitter, TAB = Collector

#### Features

- International standard packages
- 2nd generation HDMOS™ process
- Low  $V_{CE(sat)}$ 
  - for low on-state conduction losses
- High current handling capability
- MOS Gate turn-on
  - drive simplicity
- Voltage rating guaranteed at high temperature ( $125^\circ\text{C}$ )

#### Applications

- AC motor speed control
- DC servo and robot drives
- DC choppers
- Uninterruptible power supplies (UPS)
- Switch-mode and resonant-mode power supplies

#### Advantages

- Easy to mount with 1 screw (TO-247) (isolated mounting screw hole)
- High power density

Symbol	Test Conditions	Characteristic Values ( $T_J = 25^\circ\text{C}$ , unless otherwise specified)		
		min.	typ.	max.
$BV_{CES}$	$I_C = 3\text{ mA}$ , $V_{GE} = 0\text{ V}$	1000		V
$V_{GE(th)}$	$I_C = 250\ \mu\text{A}$ , $V_{CE} = V_{GE}$	2.5		5 V
$I_{CES}$	$V_{CE} = 0.8 \cdot V_{CES}$ $V_{GE} = 0\text{ V}$			$T_J = 25^\circ\text{C}$ : 250 $\mu\text{A}$ $T_J = 125^\circ\text{C}$ : 1 mA
$I_{GES}$	$V_{CE} = 0\text{ V}$ , $V_{GE} = \pm 20\text{ V}$			$\pm 100\text{ nA}$
$V_{CE(sat)}$	$I_C = I_{C90}$ , $V_{GE} = 15\text{ V}$			25N100: 3.5 V 25N100A: 4.0 V

Symbol	Test Conditions	Characteristic Values ( $T_J = 25^\circ\text{C}$ , unless otherwise specified)		
		min.	typ.	max.
$g_{fs}$	$I_C = I_{C90}$ ; $V_{CE} = 10\text{ V}$ , Pulse test, $t \leq 300\ \mu\text{s}$ , duty cycle $\leq 2\%$	8	15	S
$C_{ies}$	$V_{CE} = 25\text{ V}$ , $V_{GE} = 0\text{ V}$ , $f = 1\text{ MHz}$		2750	pF
$C_{oes}$			200	pF
$C_{res}$			50	pF
$Q_g$	$I_C = I_{C90}$ , $V_{GE} = 15\text{ V}$ , $V_{CE} = 0.5 V_{CES}$		130	180 nC
$Q_{ge}$			25	60 nC
$Q_{gc}$			55	90 nC
$t_{d(on)}$	<b>Inductive load, <math>T_J = 25^\circ\text{C}</math></b> $I_C = I_{C90}$ , $V_{GE} = 15\text{ V}$ , $L = 300\ \mu\text{H}$ , $V_{CE} = 0.8 V_{CES}$ , $R_G = R_{off} = 33\ \Omega$ Remarks: Switching times may increase for $V_{CE}$ (Clamp) $> 0.8 \cdot V_{CES}$ , higher $T_J$ or increased $R_G$		100	ns
$t_{ri}$			200	ns
$t_{d(off)}$			500	ns
$t_{fi}$		25N100A	500	ns
$E_{off}$		25N100A	5	mJ
$t_{d(on)}$	<b>Inductive load, <math>T_J = 125^\circ\text{C}</math></b> $I_C = I_{C90}$ , $V_{GE} = 15\text{ V}$ , $L = 300\ \mu\text{H}$ , $V_{CE} = 0.8 V_{CES}$ , $R_G = R_{off} = 33\ \Omega$ Remarks: Switching times may increase for $V_{CE}$ (Clamp) $> 0.8 \cdot V_{CES}$ , higher $T_J$ or increased $R_G$		100	ns
$t_{ri}$			250	ns
$E_{on}$			3.5	mJ
$t_{d(off)}$		25N100	720	1000 ns
$t_{fi}$		25N100A	950	3000 ns
$E_{off}$	25N100	800	1500 ns	
$E_{off}$	25N100A	10	mJ	
$E_{off}$	25N100A	8	mJ	
$R_{thJC}$				0.62 K/W
$R_{thCK}$		0.25		K/W

**TO-247 AD Outline**

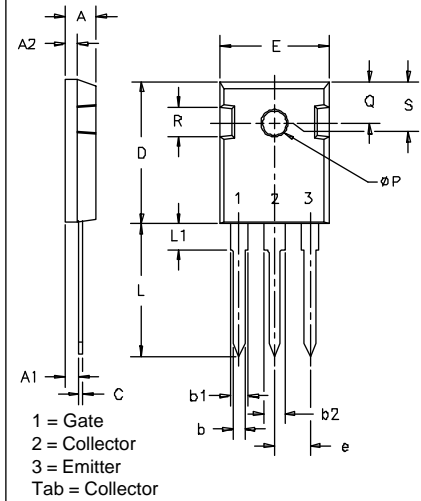

SYM	INCHES		MILLIMETERS	
	MIN	MAX	MIN	MAX
A	.185	.209	4.7	5.3
A1	.087	.102	2.2	2.54
A2	.059	.098	2.2	2.6
b	.040	.055	1.0	1.4
b1	.065	.084	1.65	2.13
b2	.113	.123	2.87	3.12
C	.016	.031	.4	.8
D	.819	.845	20.80	21.46
E	.610	.640	15.75	16.26
e	.215 BSC		5.45 BSC	
L	.780	.800	19.81	20.32
L1			4.50	
$\phi P$	.140	.144	3.55	3.65
Q	.212	.244	5.4	6.2
R	.170	.216	4.32	5.49
S			6.15 BSC	

**TO-204AE Outline**

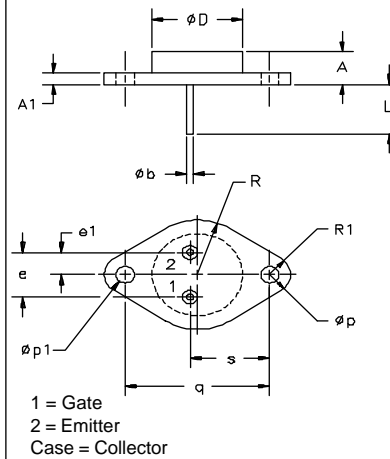

SYM	INCHES		MILLIMETERS	
	MIN	MAX	MIN	MAX
A	.250	.450	6.4	11.4
A1	.060	.135	1.53	3.42
$\phi b$	.057	.063	1.45	1.60
$\phi D$			8.75	
e	.420	.440	10.67	11.17
e1	.205	.225	5.21	5.71
L	.440	.480	11.18	12.19
$\phi p$	.151	.165	3.84	4.19
$\phi p1$	.151	.165	3.84	4.19
q	1.187 BSC		30.15 BSC	
R	.495	.525	12.58	13.33
R1	.131	.188	3.33	4.77
s	.655	.675	16.64	17.14

IXYS reserves the right to change limits, test conditions, and dimensions.

IXYS MOSFETS and IGBTs are covered by one or more of the following U.S. patents: 4,835,592 4,881,106 5,017,508 5,049,961 5,187,117 5,486,715  
 4,850,072 4,931,844 5,034,796 5,063,307 5,237,481 5,381,025

Fig. 1 Saturation Characteristics

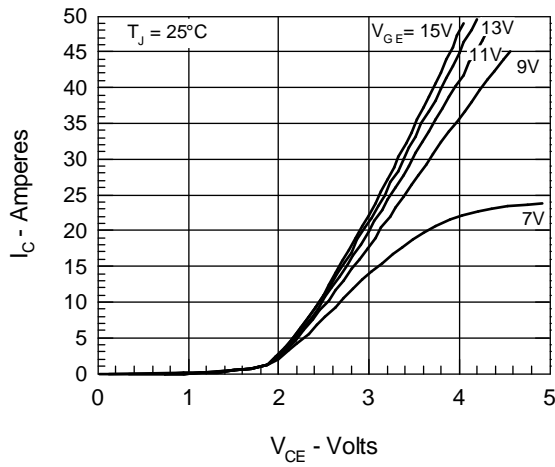

Fig. 2 Output Characteristics

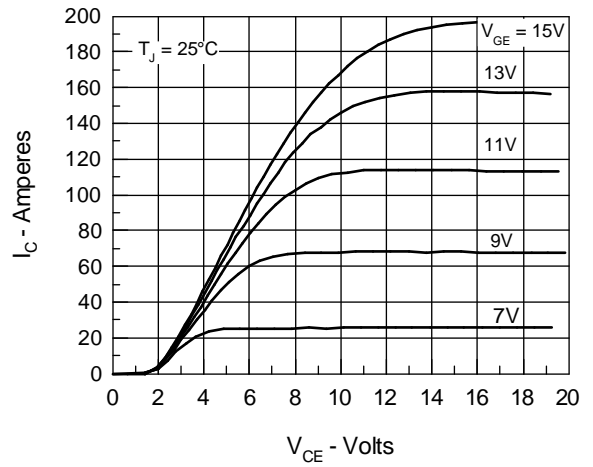

Fig. 3 Collector-Emitter Voltage vs. Gate-Emitter Voltage

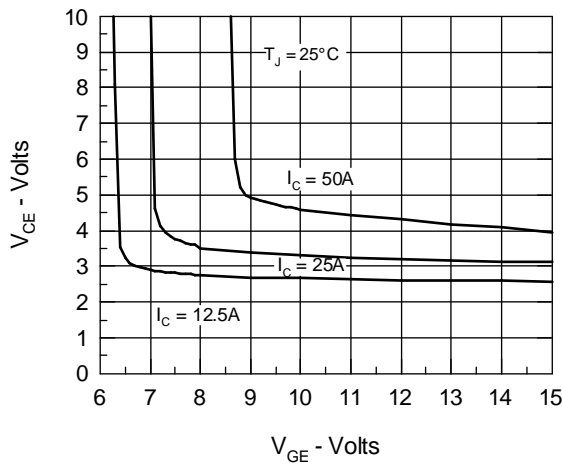

Fig. 4 Temperature Dependence of Output Saturation Voltage

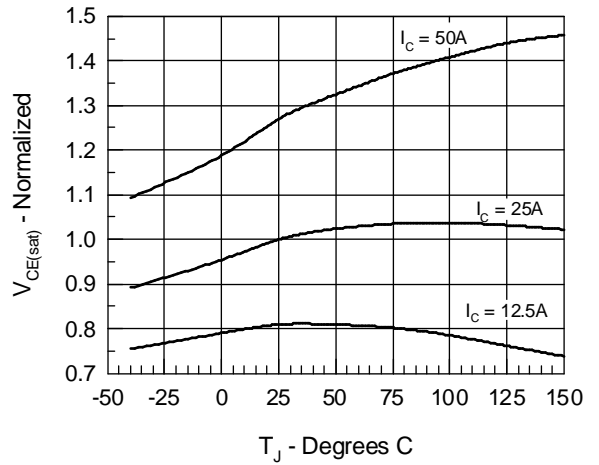

Fig. 5 Input Admittance

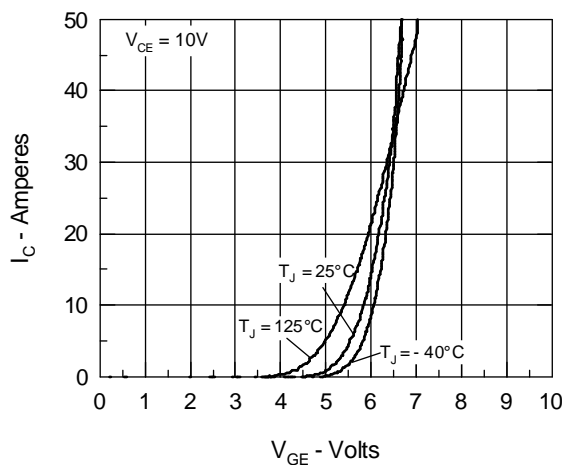

Fig. 6 Temperature Dependence of Breakdown and Threshold Voltage

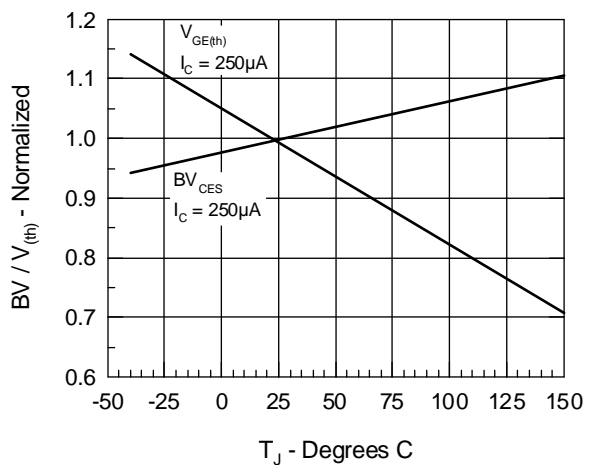

Fig.7 Gate Charge

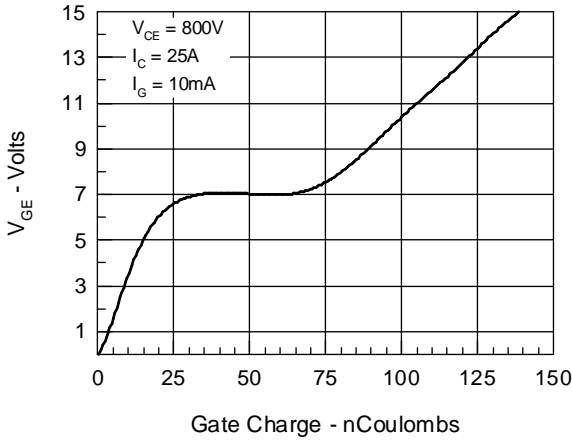

Fig.8 Turn-Off Safe Operating Area

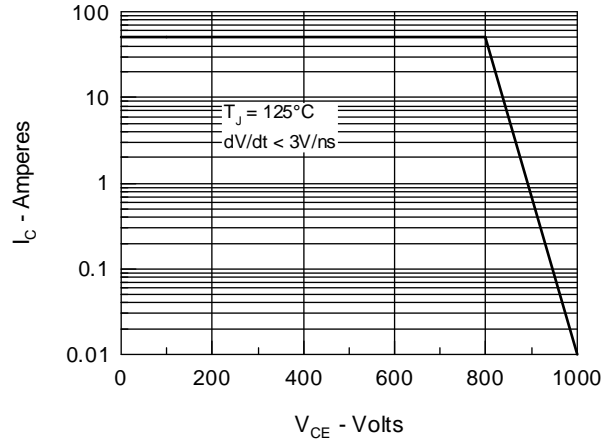

Fig.9 Capacitance Curves

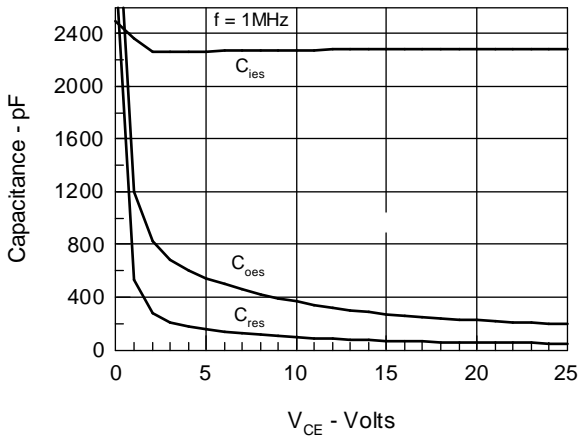
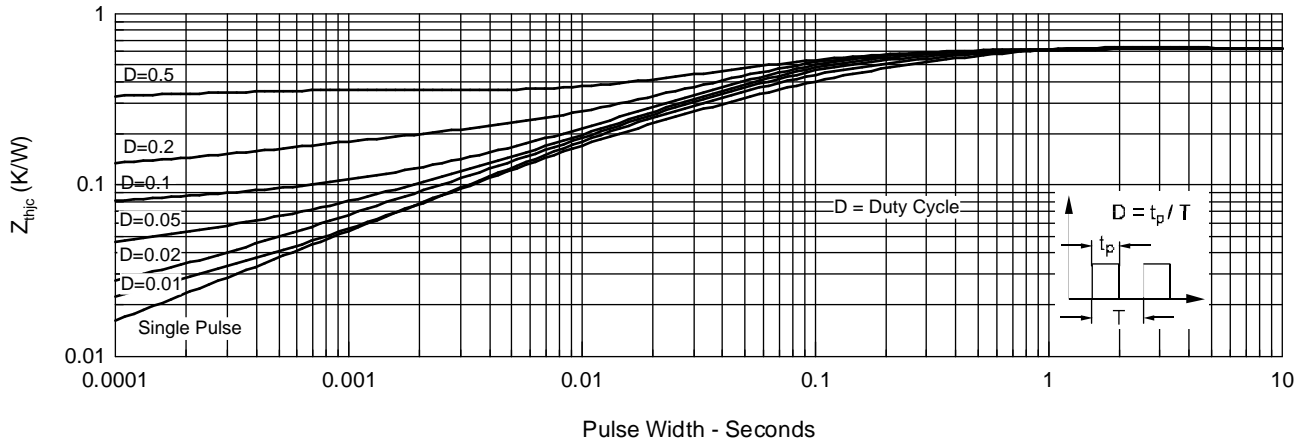

Fig.10 Transient Thermal Impedance



IXYS reserves the right to change limits, test conditions, and dimensions.

IXYS MOSFETS and IGBTs are covered by one or more of the following U.S. patents: 4,835,592 4,881,106 5,017,508 5,049,961 5,187,117 5,486,715  
4,850,072 4,931,844 5,034,796 5,063,307 5,237,481 5,381,025