



Si88x4x Data Sheet

Quad Digital Isolators with DC-DC Converter

The Si88xx integrates Silicon Labs' proven digital isolator technology with an on-chip isolated dc-dc converter that provides regulated output voltages of 3.3 or 5.0 V (or >5 V with external components) at peak output power levels of up to 5 W. These devices provide up to four digital channels. The dc-dc converter has user-adjustable frequency for minimizing emissions, a soft-start function for safety, a shut-down option and loop compensation. The device requires only minimal passive components and a miniature transformer.

The ultra-low-power digital isolation channels offer substantial data rate, propagation delay, size and reliability advantages over legacy isolation technologies. Data rates up to 100 Mbps max are supported, and all devices achieve propagation delays of only 23 ns max. Ordering options include a choice of dc-dc converter features, isolation channel configurations and a failsafe mode. All products are certified by UL, CSA, VDE, and CQC.

Automotive Grade is available for certain part numbers. These products are built using automotive-specific flows at all steps in the manufacturing process to ensure the robustness and low defectivity required for automotive applications.

Industrial Applications

- Industrial automation systems
- Medical electronics
- Isolated switch mode supplies
- Inverters
- Data Acquisition
- Motor control
- PLCs, distributed control systems

Automotive Applications

- Hybrid electric and electric vehicles
- Traction inverters
- Battery management systems
- Vehicle communication busses

Safety Regulatory Approvals

- UL 1577 recognized
 - Up to 5000 V_{RMS} for 1 minute
- CSA component notice 5A approval
 - IEC 60950
- VDE certification conformity
 - VDE0884-10
- CQC certification approval
 - GB4943.1

KEY FEATURES

- High-speed isolators with integrated dc-dc converter
- Fully-integrated secondary sensing feedback-controlled converter with dithering for low EMI
- dc-dc converter peak efficiency of 83% with external power switch
- Up to 5 W isolated power with external power switch
- Options include dc-dc shutdown, frequency control, and soft start
- Standard Voltage Conversion
 - 3/5 V to isolated 3/5 V
 - 24 V to isolated 3/5 V supported
- Precise timing on digital isolators
 - 0–100 Mbps
 - 18 ns typical prop delay
- Highly-reliable: 100 year lifetime
- High electromagnetic immunity and ultra-low emissions
- RoHS compliant packages
 - SOIC-20 wide body
 - SOIC-24 wide body
- Isolation of up to 5000 V_{RMS}
- High transient immunity of 100 kV/μs (typical)
- AEC-Q100 qualified
- Wide temp range: -40 to +125°C
- Automotive-grade OPNs available
 - AIAG compliant PPAP documentation support
 - IMDS and CAMDS listing support

Table of Contents

| | |
|--|-----------|
| 1. Feature List | 4 |
| 2. Ordering Guide | 5 |
| 3. Functional Description | 8 |
| 3.1 Theory of Operation | 8 |
| 3.2 Digital Isolation | 8 |
| 3.3 DC-DC Converter Application Information | 9 |
| 3.3.1 Shutdown | 9 |
| 3.3.2 Soft-Start | 9 |
| 3.3.3 Programmable Frequency | 9 |
| 3.3.4 External Transformer Driver | 9 |
| 3.3.5 VREGA, VREGB | 9 |
| 3.3.6 Output Voltage Control | 9 |
| 3.3.7 Compensation | 10 |
| 3.3.8 Thermal Protection | 10 |
| 3.3.9 Cycle Skipping | 10 |
| 3.3.10 Low-Voltage Configuration | 11 |
| 3.3.11 Low-Voltage to High-Voltage Configuration | 12 |
| 3.3.12 High-Voltage to Low-Voltage Configuration | 13 |
| 3.3.13 High-Voltage Configuration | 14 |
| 3.4 Transformer Design | 15 |
| 4. Digital Isolator Device Operation | 17 |
| 4.1 Device Startup | 17 |
| 4.2 Undervoltage Lockout | 17 |
| 4.3 Layout Recommendations | 17 |
| 4.3.1 Supply Bypass | 17 |
| 4.3.2 Output Pin Termination | 18 |
| 4.4 Fail-Safe Operating Mode | 18 |
| 4.5 Typical Performance Characteristics | 19 |
| 5. Electrical Specifications | 24 |
| 5.1 Calculating Total Current Consumption | 37 |
| 6. Pin Descriptions | 38 |
| 7. Package Outline: 20-Pin Wide Body SOIC | 43 |
| 8. Land Pattern: 20-Pin SOIC | 45 |
| 9. Package Outline: 24-Pin Wide Body SOIC | 46 |
| 10. Land Pattern: 24-Pin SOIC | 48 |
| 11. Top Markings | 49 |
| 11.1 Si88x4x Top Marking (20-Pin Wide Body SOIC) | 49 |

| | |
|--|-----------|
| 11.2 Top Marking Explanation (20-Pin Wide Body SOIC) | .49 |
| 11.3 Si88x4x Top Marking (24-Pin Wide Body SOIC) | .50 |
| 11.4 Top Marking Explanation (24-Pin Wide Body SOIC) | .50 |
| 12. Revision History. | 51 |

1. Feature List

- High-speed isolators with integrated dc-dc converter
- Fully-integrated secondary sensing feedback-controlled converter with dithering for low EMI
- dc-dc converter peak efficiency of 83% with external power switch
- Up to 5 W isolated power with external power switch
- Options include dc-dc shutdown, frequency control, and soft start
- Standard Voltage Conversion
 - 3/5 V to isolated 3/5 V
 - 24 V to isolated 3/5 V supported
- Precise timing on digital isolators
 - 0–100 Mbps
 - 18 ns typical prop delay
- Highly-reliable: 100 year lifetime
- High electromagnetic immunity and ultra-low emissions
- RoHS compliant packages
 - SOIC-20 wide body
 - SOIC-24 wide body
- Isolation of up to 5000 V_{RMS}
- High transient immunity of 100 kV/μs (typical)
- AEC-Q100 qualified
- Wide temp range: -40 to +125°C

2. Ordering Guide

Table 2.1. Si88x4x Ordering Guide^{1,2,3,4}

| Ordering Part Number | DC-DC Shutdown | Soft Start Control | Frequency Control | External Switch | Forward Digital Channels | Reverse Digital Channels | Insulation Rating | Package |
|----------------------|----------------|--------------------|-------------------|-----------------|--------------------------|--------------------------|------------------------|------------|
| Available Now | | | | | | | | |
| Si88240BC-IS | Y | N | N | N | 4 | 0 | 3.75 kV _{RMS} | WB SOIC-20 |
| Si88240EC-IS | Y | N | N | N | 4 | 0 | 3.75 kV _{RMS} | WB SOIC-20 |
| Si88241BC-IS | Y | N | N | N | 3 | 1 | 3.75 kV _{RMS} | WB SOIC-20 |
| Si88241EC-IS | Y | N | N | N | 3 | 1 | 3.75 kV _{RMS} | WB SOIC-20 |
| Si88242BC-IS | Y | N | N | N | 2 | 2 | 3.75 kV _{RMS} | WB SOIC-20 |
| Si88242EC-IS | Y | N | N | N | 2 | 2 | 3.75 kV _{RMS} | WB SOIC-20 |
| Si88243BC-IS | Y | N | N | N | 1 | 3 | 3.75 kV _{RMS} | WB SOIC-20 |
| Si88243EC-IS | Y | N | N | N | 1 | 3 | 3.75 kV _{RMS} | WB SOIC-20 |
| Si88244BC-IS | Y | N | N | N | 0 | 4 | 3.75 kV _{RMS} | WB SOIC-20 |
| Si88244EC-IS | Y | N | N | N | 0 | 4 | 3.75 kV _{RMS} | WB SOIC-20 |
| Si88340EC-IS | Y | Y | Y | N | 4 | 0 | 3.75 kV _{RMS} | WB SOIC-24 |
| Si88341EC-IS | Y | Y | Y | N | 3 | 1 | 3.75 kV _{RMS} | WB SOIC-24 |
| Si88342EC-IS | Y | Y | Y | N | 2 | 2 | 3.75 kV _{RMS} | WB SOIC-24 |
| Si88343EC-IS | Y | Y | Y | N | 1 | 3 | 3.75 kV _{RMS} | WB SOIC-24 |
| Si88344EC-IS | Y | Y | Y | N | 0 | 4 | 3.75 kV _{RMS} | WB SOIC-24 |
| Si88440EC-IS | N | N | N | Y | 4 | 0 | 3.75 kV _{RMS} | WB SOIC-20 |
| Si88441EC-IS | N | N | N | Y | 3 | 1 | 3.75 kV _{RMS} | WB SOIC-20 |
| Si88442EC-IS | N | N | N | Y | 2 | 2 | 3.75 kV _{RMS} | WB SOIC-20 |
| Si88443EC-IS | N | N | N | Y | 1 | 3 | 3.75 kV _{RMS} | WB SOIC-20 |
| Si88444EC-IS | N | N | N | Y | 0 | 4 | 3.75 kV _{RMS} | WB SOIC-20 |
| Si88640EC-IS | Y | Y | Y | Y | 4 | 0 | 3.75 kV _{RMS} | WB SOIC-24 |
| Si88641EC-IS | Y | Y | Y | Y | 3 | 1 | 3.75 kV _{RMS} | WB SOIC-24 |
| Si88642EC-IS | Y | Y | Y | Y | 2 | 2 | 3.75 kV _{RMS} | WB SOIC-24 |
| Si88643EC-IS | Y | Y | Y | Y | 1 | 3 | 3.75 kV _{RMS} | WB SOIC-24 |
| Si88644EC-IS | Y | Y | Y | Y | 0 | 4 | 3.75 kV _{RMS} | WB SOIC-24 |
| Sample Now | | | | | | | | |
| Si88240BD-IS | Y | N | N | N | 4 | 0 | 5.0 kV _{RMS} | WB SOIC-20 |
| Si88240ED-IS | Y | N | N | N | 4 | 0 | 5.0 kV _{RMS} | WB SOIC-20 |
| Si88241BD-IS | Y | N | N | N | 3 | 1 | 5.0 kV _{RMS} | WB SOIC-20 |

| Ordering Part Number | DC-DC Shutdown | Soft Start Control | Frequency Control | External Switch | Forward Digital Channels | Reverse Digital Channels | Insulation Rating | Package |
|----------------------|----------------|--------------------|-------------------|-----------------|--------------------------|--------------------------|-----------------------|------------|
| Si88241ED-IS | Y | N | N | N | 3 | 1 | 5.0 kV _{RMS} | WB SOIC-20 |
| Si88242BD-IS | Y | N | N | N | 2 | 2 | 5.0 kV _{RMS} | WB SOIC-20 |
| Si88242ED-IS | Y | N | N | N | 2 | 2 | 5.0 kV _{RMS} | WB SOIC-20 |
| Si88243BD-IS | Y | N | N | N | 1 | 3 | 5.0 kV _{RMS} | WB SOIC-20 |
| Si88243ED-IS | Y | N | N | N | 1 | 3 | 5.0 kV _{RMS} | WB SOIC-20 |
| Si88244BD-IS | Y | N | N | N | 0 | 4 | 5.0 kV _{RMS} | WB SOIC-20 |
| Si88244ED-IS | Y | N | N | N | 0 | 4 | 5.0 kV _{RMS} | WB SOIC-20 |
| Si88340ED-IS | Y | Y | Y | N | 4 | 0 | 5.0 kV _{RMS} | WB SOIC-24 |
| Si88341ED-IS | Y | Y | Y | N | 3 | 1 | 5.0 kV _{RMS} | WB SOIC-24 |
| Si88342ED-IS | Y | Y | Y | N | 2 | 2 | 5.0 kV _{RMS} | WB SOIC-24 |
| Si88343ED-IS | Y | Y | Y | N | 1 | 3 | 5.0 kV _{RMS} | WB SOIC-24 |
| Si88344ED-IS | Y | Y | Y | N | 0 | 4 | 5.0 kV _{RMS} | WB SOIC-24 |
| Si88440ED-IS | N | N | N | Y | 4 | 0 | 5.0 kV _{RMS} | WB SOIC-20 |
| Si88441ED-IS | N | N | N | Y | 3 | 1 | 5.0 kV _{RMS} | WB SOIC-20 |
| Si88442ED-IS | N | N | N | Y | 2 | 2 | 5.0 kV _{RMS} | WB SOIC-20 |
| Si88443ED-IS | N | N | N | Y | 1 | 3 | 5.0 kV _{RMS} | WB SOIC-20 |
| Si88444ED-IS | N | N | N | Y | 0 | 4 | 5.0 kV _{RMS} | WB SOIC-20 |
| Si88640ED-IS | Y | Y | Y | Y | 4 | 0 | 5.0 kV _{RMS} | WB SOIC-24 |
| Si88642ED-IS | Y | Y | Y | Y | 2 | 2 | 5.0 kV _{RMS} | WB SOIC-24 |
| Si88643ED-IS | Y | Y | Y | Y | 1 | 3 | 5.0 kV _{RMS} | WB SOIC-24 |
| Si88644ED-IS | Y | Y | Y | Y | 0 | 4 | 5.0 kV _{RMS} | WB SOIC-24 |

Note:

1. All packages are RoHS-compliant with peak solder reflow temperatures of 260°C according to the JEDEC industry standard classifications.
2. “Si” and “SI” are used interchangeably.
3. AEC-Q100 qualified.
4. All Si88xxxEx product options are default output high on input power loss. All Si88xxxBx product options are default low. See Chapter 4. [Digital Isolator Device Operation](#) for more details about default output behavior.

Automotive Grade OPNs

Automotive-grade devices are built using automotive-specific flows at all steps in the manufacturing process to ensure robustness and low defectivity. These devices are supported with AIAG-compliant Production Part Approval Process (PPAP) documentation, and feature International Material Data System (IMDS) and China Automotive Material Data System (CAMDS) listing. Qualifications are compliant with AEC-Q100, and a zero-defect methodology is maintained throughout definition, design, evaluation, qualification, and mass production steps.

Table 2.2. Ordering Guide for Automotive Grade OPNs^{1, 2, 4, 5}

| Ordering Part Number | DC-DC Shutdown | Soft Start Control | Frequency Control | External Switch | Forward Digital Channels | Reverse Digital Channels | Insulation Rating | Package |
|----------------------|----------------|--------------------|-------------------|-----------------|--------------------------|--------------------------|------------------------|------------|
| Available Now | | | | | | | | |
| Si88241EC-AS | Y | N | N | N | 3 | 1 | 3.75 kV _{RMS} | WB SOIC-20 |
| Si88342EC-AS | Y | Y | Y | N | 2 | 2 | 3.75 kV _{RMS} | WB SOIC-24 |
| Si88642EC-AS | Y | Y | Y | Y | 2 | 2 | 3.75 kV _{RMS} | WB SOIC-24 |
| Sample Now | | | | | | | | |
| Si88241ED-AS | Y | N | N | N | 3 | 1 | 5.0 kV _{RMS} | WB SOIC-20 |

Note:

1. All packages are RoHS-compliant.
2. "Si" and "SI" are used interchangeably.
3. An "R" at the end of the part number denotes tape and reel packaging option.
4. Automotive-Grade devices (with an "-A" suffix) are identical in construction materials, topside marking, and electrical parameters to their Industrial-Grade (with a "-I" suffix) version counterparts. Automotive-Grade products are produced utilizing full automotive process flows and additional statistical process controls throughout the manufacturing flow. The Automotive-Grade part number is included on shipping labels.
5. Additional Ordering Part Numbers may be available in Automotive-Grade. Please contact your local Silicon Labs sales representative for further information.
6. In Section 11. [Top Markings](#), the Manufacturing Code represented by either "RTTTTT" or "TTTTTT" contains as its first character a letter in the range N through Z to indicate Automotive-Grade.

3. Functional Description

3.1 Theory of Operation

The Si88xx family of products is capable of transmitting and receiving digital data signals from an isolated power domain to a local system power domain with up to 5 kV of isolation. Each part has four unidirectional digital isolation channels. In addition, Si88xx products include an integrated controller and switches for a dc-dc converter which regulates output voltage by sensing it on the isolated side.

3.2 Digital Isolation

The operation of an Si88xx digital channel is analogous to that of a digital buffer, except an RF carrier transmits data across the isolation barrier. This simple architecture provides a robust isolated data path and requires no special considerations or initialization at start-up. A simplified block diagram for a single Si88xx channel is shown in the following figure.



Figure 3.1. Simplified Si88xx Channel Diagram

A channel consists of an RF Transmitter and RF Receiver separated by a silicon dioxide capacitive isolation barrier. In the transmitter, input A modulates the carrier provided by an RF oscillator using on/off keying. The receiver contains a demodulator that decodes the input state according to its RF energy content and applies the result to output B via the output driver. This RF on/off keying scheme is superior to pulse code schemes as it provides best-in-class noise immunity, low power consumption, and better immunity to magnetic fields. See [Figure 3.2 Modulation Scheme on page 8](#) for more details.



Figure 3.2. Modulation Scheme

3.3 DC-DC Converter Application Information

The Si88xx isolated dc-dc converter is based on a modified fly-back topology and uses an external transformer and Schottky rectifying diode for low cost and high operating efficiency. The PWM controller operates in closed-loop, peak current mode control and generates isolated output voltages with 2 W average output power at 5.0 V. Options are available for 24 Vdc input or output operation and externally configured switching frequency.

The dc-dc controller modulates a pair of internal primary-side power switches (see [Figure 3.3 Si883xx Block Diagram: 3 V–5 V Input to 3 V–5 V Output on page 11](#)) to generate an isolated voltage at external diode D1 cathode. Closed-loop feedback is provided by a compensated error amplifier, which compares the voltage at the VSNS pin to an internal voltage reference. The resulting error voltage is fed back through the isolation barrier via an internal feedback path to the controller, thus completing the control loop.

For higher input supply voltages than 5 V, an external FET Q2 is modulated by a driver pin ESW as shown in (see [Figure 3.6 Si886xx Block Diagram: 24 V Input to 5 V Output on page 14](#)). A shunt resistor based voltage sense pin RSN provides current sensing capability to the controller.

Additional features include an externally-triggered shutdown of the converter functionality using the SH pin and a programmable soft start configured by a capacitor connected to the SS pin. The Si88xx can be used in low- or high-voltage configurations. These features and configurations are explained in more detail below.

3.3.1 Shutdown

This feature allows the operation of the dc-dc converter to be shut down when asserted high. This function is provided by pin 6 (labeled “SH” on the Si882xx) and pin 7 (labeled “SH_FC” on the Si883xx and Si886xx). This feature is not available on the Si884xx. Pin 6 or pin 7 provide the exact same functionality and shut down the dc-dc converter when asserted high. For normal operation, pins 6 and 7 should be connected to ground.

3.3.2 Soft-Start

The dc-dc controller has an internal timer that controls the power conversion start-up to limit inrush current. There is also the Soft Start option where users can program the soft start up by an external capacitor connected to the SS pin. This feature is available on the Si883xx and the Si886xx.

3.3.3 Programmable Frequency

The frequency of the PWM modulator is set to a default of 250 kHz for Si882xx/4xx. Users can program their desired frequency within a given band of 200 kHz to 800 kHz by controlling the time constant of an external RC connected to the SH_FC and SS pins for Si883xx/6xx.

3.3.4 External Transformer Driver

The dc-dc controller has internal switches (VSW) for driving the transformer with up-to a 5.5 V voltage supply. For higher voltages on the primary side, a driver output (ESW) is provided that can drive an external NMOS power transistor for driving the transformer. When this configuration is used, a shunt resistor based voltage sense pin (RSN) provides current sensing to the controller.

3.3.5 VREGA, VREGB

For supporting voltages greater than 5.5 V, an internal voltage regulator (VREGA, VREGB) needs to be used in conjunction with an external NPN transistor, a resistor and a capacitor to provide regulated voltage to the IC.

3.3.6 Output Voltage Control

The isolated output voltage (VOUT) is sensed by a resistor divider that provides feedback to the controller through the VSNS pin. The voltage error is encoded and transmitted back to the primary side controller across the isolation barrier, which in turn changes the duty cycle of the transformer driver. The equation for VOUT is as follows:

$$VOUT = VSNS \times \left(1 + \frac{R1}{R2}\right) + R1 \times I_{OFFSET}$$

3.3.7 Compensation

The dc-dc converter uses peak current mode control. The loop is compensated by connecting an external resistor in series with a capacitor from the COMP pin to GNDB. The compensation resistance, RCOMP is fixed at 49.9 kΩ for Si882xx/3xx and 100 kΩ for Si884xx/6xx to match internal resistance. Capacitance value is given by the following equation, where f_C is crossover frequency:

$$C_{COMP} = \frac{6}{2 \times \pi \times f_C \times R_{COMP}}$$

For more details on the calculations involved, please see *AN892: Design Guide for Isolated DC/DC Using the Si882xx/883xx*.

3.3.8 Thermal Protection

A thermal shutdown circuit is included to protect the system from over-temperature events. The thermal shutdown is activated at a junction temperature that prevents permanent damage from occurring.

3.3.9 Cycle Skipping

Cycle skipping is included to reduce switching power losses at light loads. This feature is transparent to the user and is activated automatically at light loads. The product options with integrated power switches (Si882xx/3xx) may never experience cycle skipping during operation even at light loads while the external power switch options (Si884xx/6xx) are likely to have cycle skipping start at light loads.

3.3.10 Low-Voltage Configuration

The low-voltage configuration is used for converting 3.0 V to 5.5 V. All product options of the Si882xx and Si883xx are intended for this configuration.

An advantage of Si88xx devices over other converters that use this same topology is that the output voltage is sensed on the secondary side without requiring additional optocouplers and support circuitry to bias those optocouplers. This allows the dc-dc to operate with superior line and load regulation while reducing external components and increasing lifetime reliability.

In a typical digital signal isolation application, the dc-dc powers the Si882xx and Si883xx VDDB as shown in the figure below. In addition to powering the isolated side of the dc-dc can deliver up to 2 W of power to other loads. The dc-dc requires an input capacitor, C2, blocking capacitor, C1, transformer, T1, rectifying diode, D1, and an output capacitor, C3. Resistors R1 and R2 divide the output voltage to match the internal reference of the error amplifier. Type 1 loop compensation made by RCOMP and CCOMP are required at the COMP pin. Though it is not necessary for normal operation, we recommend that a snubber be used to minimize radiated emissions. More details can be found in “AN892: Design Guide for Isolated DC-DC Using the Si882xx/883xx”.



Figure 3.3. Si883xx Block Diagram: 3 V–5 V Input to 3 V–5 V Output

3.3.11 Low-Voltage to High-Voltage Configuration

The low-voltage to high-voltage configuration is used for converting 3.0 V – 5.5 V up to 24 V.

In a typical digital signal isolation application, the dc-dc powers the Si882xx and Si883xx VOUT as shown in the figure below. In addition to powering the isolated side of the dc-dc, it can deliver up to 2 W of power to other loads. The dc-dc requires an input capacitor, C2, blocking capacitor, C1, transformer, T1, rectifying diode, D1, and an output capacitor, C3. Resistors R1 and R2 divide the output voltage to match the internal reference of the error amplifier. To supply VDDB that requires voltage lower than 5.5 V, Q3 transistor is biased and filtered by R5 and C4. Type 1 loop compensation made by RCOMP and CCOMP are required at the COMP pin. Though it is not necessary for normal operation, we recommend that a snubber be used to minimize radiated emissions. More details can be found in AN892: *Design Guide for Isolated DC-DC Using the Si882xx/883xx*.



Figure 3.4. Si883xx Block Diagram: 3 V – 5 V Input to up to 24 V Output

3.3.12 High-Voltage to Low-Voltage Configuration

The high-voltage configuration is used for converting up to 24 V to 3.3 V or 5.0 V. All product options of the Si884xx and Si886xx are intended for this configuration.

Si884xx and Si886xx can be used for dc-dc applications that have primary side voltage greater than 5.5 V. The dc-dc converter uses the isolated flyback topology. With this topology, the switch and sense resistor are external, allowing higher switching voltages. Digital isolator supply VDDA of the Si884xx and Si886xx require a supply less than or equal to 5.5 V. If a suitable supply is not available on the primary side, the VREGA voltage reference with external NPN transistor can supply VDDA. This eliminates the need to design an additional linear regulator circuit. Like the Si882xx and Si883xx, the output voltage is sensed on the secondary side without requiring additional optocouplers and support circuitry to bias those optocouplers. This allows the dc-dc to operate with superior line and load regulation.

The figure below shows the block diagram of an Si886xx with external components. Si886xx is different from the Si882xx/883xx as it has externally-controlled switching frequency and soft start. The dc-dc requires input capacitor C2, transformer T1, switch Q1, sense resistor R4, rectifying diode D1 and an output capacitor C3. To supply VDDA, Q2 transistor is biased and filtered by R3 and C1. External frequency and soft start behavior is set by CSS and RFSW. Resistors R1 and R2 divide the output voltage to match the internal reference of the error amplifier. Type 1 loop compensation made by RCOMP and CCOMP are required at the COMP pin. Though it is not necessary for normal operation, we recommend to use a snubber, to minimize high-frequency emissions. For further details, see AN901: *Design Guide for Isolated DC-DC Using the Si884xx/886xx*.



Figure 3.5. Si886xx Block Diagram: 24 V Input to 5 V Output

3.3.13 High-Voltage Configuration

The high-voltage configuration is used for converting input voltage up to 24 V to output voltage as high as 24 V. All product options of the Si884xx and Si886xx are intended for this configuration.

Si884xx and Si886xx can be used for dc-dc applications that have primary side voltage greater than 5.5 V. The dc-dc converter uses the isolated flyback topology. With this topology, the switch and sense resistor are external, allowing higher switching voltages. Digital isolator supply VDDA of the Si884xx and Si886xx require a supply less than or equal to 5.5 V. If a suitable supply is not available on the primary side, the VREGA voltage reference with external NPN transistor Q2 can supply VDDA. This eliminates the need to design an additional linear regulator circuit. Like the Si882xx and Si883xx, the output voltage is sensed on the secondary side without requiring additional optocouplers and support circuitry to bias those optocouplers. This allows the dc-dc to operate with superior line and load regulation.

Figure 3.6 Si886xx Block Diagram: 24 V Input to 5 V Output on page 14 shows the block diagram of an Si886xx with external components. Si886xx is different from the Si882xx/883xx as it has externally-controlled switching frequency and soft start. The dc-dc requires input capacitor C2, transformer T1, switch Q1, sense resistor R4, rectifying diode D1 and an output capacitor C3. To supply VDDB, Q3 transistor is biased and filtered by R5 and C4. External frequency and soft start behavior is set by CSS and RFSW. Resistors R1 and R2 divide the output voltage to match the internal reference of the error amplifier. Type 1 loop compensation made by RCOMP and CCOMP are required at the COMP pin. Though it is not necessary for normal operation, we recommend to use a snubber, to minimize high-frequency emissions. For further details, see “AN901: Design Guide for Isolated DC-DC Using the Si884xx/886xx”.

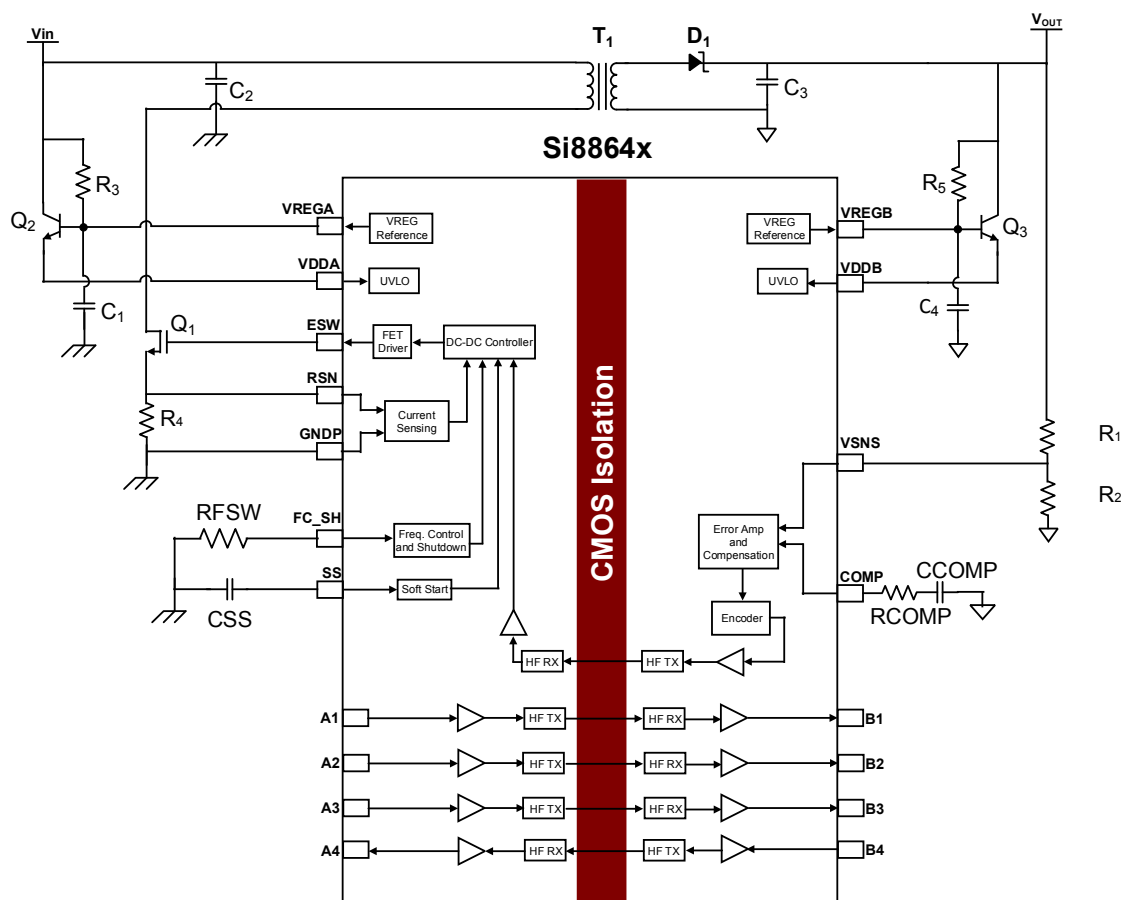

Figure 3.6. Si886xx Block Diagram: 24 V Input to 5 V Output

3.4 Transformer Design

The following table provides a list of transformers and their parametric characteristics that have been validated to work with Si882xx/3xx products (input voltage 3 to 5 V) and Si884xx/Si886xx products (input voltage of 24 V). It is recommended that users order the transformers from the vendors per the part numbers given below. Refer to AN892 and AN901 for voltage translation applications not listed below.

To manufacture transformers from your preferred suppliers that may not be listed below, please specify to supplier the parametric characteristics as specified in the table below for a given input voltage and isolation rating.

Table 3.1. Transformer Specifications

| Transformer Supplier | Ordering Part # | Input Voltage | Output Voltage | Turns Ratio P:S | Leakage Inductance | Primary Inductance | Primary Resistance | Isolation Rating |
|--|-----------------|---------------|-----------------|--------------------|--------------------|-----------------------|--------------------|-----------------------|
| UMEC (http://www.umec-usa.com) | UTB02185s | 4.5 – 5.5 V | 3.0 – 5.5V | 1.0:4.0 | 100 nH max | 2 μ H \pm 5% | 0.05 Ω max | 2.5 kV _{RMS} |
| UMEC (http://www.umec-usa.com) | UTB02205s | 12V, 24V | 3.3 – 5.0V, 15V | 3.0:1.0 | 800 nH max | 25 μ H \pm 5% | 0.135 Ω max | 2.5 kV _{RMS} |
| UMEC (http://www.umec-usa.com) | UTB02240s | 4.5 – 5.5V | 3.0 – 5.5V | 1.0:4.0 | 100 nH max | 2 μ H \pm 5% | 0.05 Ω max | 5 kV _{RMS} |
| UMEC (http://www.umec-usa.com) | UTB02250s | 7 – 24 V | 3.3 – 5.5V | 3.0:1.0 | 600 nH max | 25 μ H \pm 5% | 0.135 Ω max | 5 kV _{RMS} |
| Coilcraft ¹ (http://www.coilcraft.com) | TA7608-AL | 4.5 – 5.5 V | 3.0 – 5.5V | 1.0:4.0 | 60 nH max | 2 μ H \pm 5% | 0.033 Ω max | 2.5 kV _{RMS} |
| Coilcraft ¹ (http://www.coilcraft.com) | TA7618-AL | 4.5 – 5.5V | 3.0 – 5.5V | 1.0:4.0 | 64 nH max | 2.0 μ H \pm 5% | 0.031 Ω max | 5 kV _{RMS} |
| Coilcraft ¹ (http://www.coilcraft.com) | TA7788-AL | 12V | 5V, 15V | 1.00 : 1.25 : 0.75 | 554 nH max | 25 μ H \pm 5% | 0.49 Ω max | 5 kV _{RMS} |
| Coilcraft ¹ (http://www.coilcraft.com) | UA7902 | 12V | 5V, 15V | 3.0:1.0 | 971 nH max | 25 μ H \pm 5% | 0.075 Ω max | 5 kV _{RMS} |
| TDK (http://www.tdk.com) | P100940_A1 | 4.5 – 5.5V | 3.0 – 5.5V | 1.0:4.0 | 40 nH max | 2.0 μ H \pm 10% | 0.1 Ω max | 2.4 kV _{RMS} |
| Mentech ¹ (http://www.mnctek.com) | TTER09-0457S1 | 8 - 24 V | 15V, 24V | 1.0:1.0 | 550 nH max | 25 μ H \pm 10% | 0.4 Ω max | 2.5 kV _{RMS} |
| Mentech ¹ (http://www.mnctek.com) | TTER09-0458S1 | 8 - 24 V | 8 - 24 V | 1.0:1.0 | 550 nH max | 25 μ H \pm 10% | 0.4 Ω max | 5 kV _{RMS} |

| Transformer Supplier | Ordering Part # | Input Voltage | Output Voltage | Turns Ratio P:S | Leakage Inductance | Primary Inductance | Primary Resistance | Isolation Rating |
|---|-----------------|---------------|----------------|-----------------|--------------------|----------------------|--------------------|-----------------------|
| Mentech ¹ (http://www.mnc-tek.com) | TTEP09-0568S1 | 3.0 - 5.5 V | 5.0 V | 1.0:4.0 | 100 nH max | 1.5 μ H \pm 8% | 0.05 Ω max | 5 kV _{RMS} |
| Pulse (http://www.pulseelectronics.com/) | PA4896NL | 8 – 24 V | 7 – 24 V | 1.0:1.0 | 650 nH max | 25 μ H \pm 10% | 0.25 Ω max | 2.5 kV _{RMS} |
| Pulse (http://www.pulseelectronics.com/) | PA4897NL | 8 – 24 V | 7 – 24 V | 1.0:1.0 | 650 nH max | 25 μ H \pm 10% | 0.25 Ω max | 5 kV _{RMS} |

Notes:

1. AEC-Q200 qualified.
2. For reference design details, see *AN892: Design Guide for Isolated DC/DC using the Si882xx/883xx* or *AN901: Design Guide for Isolated DC/DC using the Si884xx/886xx*.

4. Digital Isolator Device Operation

Table 4.1. Si88xx Logic Operation

| VI Input | VDDI ^{1, 2, 3, 4} | VDDO ^{1, 2, 3, 4} | VO Output | Comments |
|----------|----------------------------|----------------------------|----------------------------------|--|
| H | P | P | H | Normal operation. |
| L | P | P | L | |
| X | UP | P | L ⁴ H ⁴ | Upon transition of VDDI from un-powered to powered, V _O returns to the same state as V _I . |
| X | P | UP | Undetermined | Upon transition of VDDO from un-powered to powered, V _O returns to the same state as V _I . |

Note:

1. VDDI and VDDO are the input and output power supplies. VI and VO are the respective input and output terminals.
2. P = powered; UP = unpowered.
3. Note that an I/O can power the die for a given side through an internal diode if its source has adequate current. This situation should be avoided. We recommend that I/O's not be driven high when primary side supply is turned off or when in dc-dc shut-down mode.
4. See Chapter 2. [Ordering Guide](#) for details. This is the selectable fail-safe operating mode (ordering option). When VDDB is powered via the primary side and the integrated dc-dc, the default outputs are undetermined as secondary side power is not available when primary side power shuts off.

4.1 Device Startup

Outputs are held low during power up until VDDx is above the UVLO threshold for time period t_{SU} . Following this, the outputs follow the states of inputs.

4.2 Undervoltage Lockout

Undervoltage Lockout (UVLO) is provided to prevent erroneous operation during device startup and shutdown or when VDDx is below its specified operating circuits range. Both Side A and Side B each have their own undervoltage lockout monitors. Each side can enter or exit UVLO independently. For example, Side A unconditionally enters UVLO when VDDA falls below V_{DDUV-} and exits UVLO when VDDA rises above V_{DDUV+} . Side B operates the same as Side A with respect to its VDD supply.

4.3 Layout Recommendations

To ensure safety in the end user application, high voltage circuits (i.e., circuits with $>30 V_{AC}$) must be physically separated from the safety extra-low voltage circuits (SELV is a circuit with $<30 V_{AC}$) by a certain distance (creepage/clearance). If a component, such as a digital isolator, straddles this isolation barrier, it must meet those creepage/clearance requirements and also provide a sufficiently large high-voltage breakdown protection rating (commonly referred to as working voltage protection), and detail the working voltage and creepage/clearance capabilities of the Si88xx. These tables also detail the component standards (UL1577, VDE0884-10, CSA 5A), which are readily accepted by certification bodies to provide proof for end-system specifications requirements. Refer to the end-system specification (61010-1, 60950-1, 60601-1, etc.) requirements before starting any design that uses a digital isolator.

4.3.1 Supply Bypass

The Si88xx family requires a 0.1 μF bypass capacitor between all VDDx and their associated GNDx. The capacitor should be placed as close as possible to the package. To enhance the robustness of a design, the user may also include resistors (50–300 Ω) in series with the inputs and outputs if the system is excessively noisy.

4.3.2 Output Pin Termination

The nominal output impedance of an isolator driver channel is approximately $50\ \Omega$, $\pm 40\%$, which is a combination of the value of the on-chip series termination resistor and channel resistance of the output driver FET. When driving high-impedance terminated PCB traces, output pins should be source-terminated to minimize reflections.

4.4 Fail-Safe Operating Mode

Si88xx devices feature a selectable (by ordering option) mode whereby the default output state (when the input supply is unpowered) can either be a logic high or logic low when the output supply is powered. See [Table 4.1 Si88xx Logic Operation on page 17](#) and [Table 2.1 Si88x4x Ordering Guide^{1,2,3,4} on page 5](#) for more information.

4.5 Typical Performance Characteristics

The typical performance characteristics are for information only. Refer to [Table 5.2 Electrical Characteristics¹](#) on page 24 for specification limits. The data below is for all channels switching.



Figure 4.1. Si88240 Typical V_{DDA} Supply Current vs. Data Rate (5 and 3.3 V Operation)

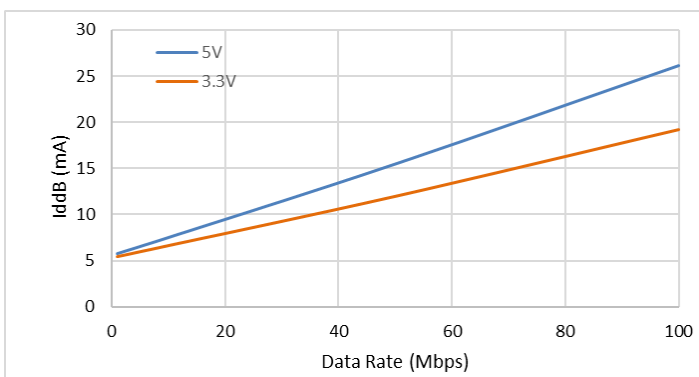

Figure 4.2. Si88240 Typical V_{ddb} Supply Current vs. Data Rate (5 and 3.3 V Operation)



Figure 4.3. Si88241 Typical V_{DDA} Supply Current vs. Data Rate (5 and 3.3 V Operation)

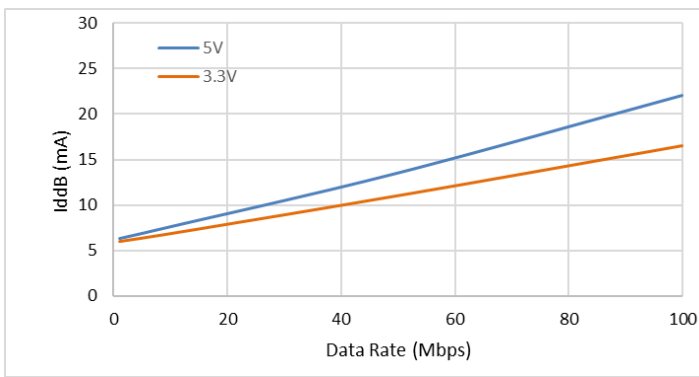

Figure 4.4. Si88241 Typical V_{ddb} Supply Current vs. Data Rate (5 and 3.3 V Operation)



Figure 4.5. Si88242 Typical V_{DDA} Supply Current vs. Data Rate (5 and 3.3 V Operation)

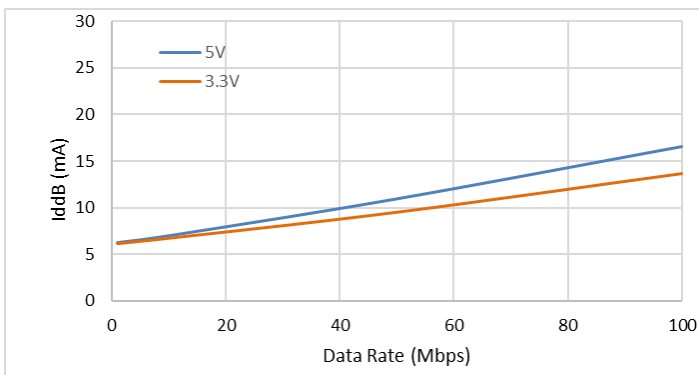

Figure 4.6. Si88242 Typical V_{ddb} Supply Current vs. Data Rate (5 and 3.3 V Operation)



Figure 4.7. Si88243 Typical V_{DDA} Supply Current vs. Data Rate (5 and 3.3 V Operation)



Figure 4.8. Si88243 Typical V_{DDB} Supply Current vs. Data Rate (5 and 3.3 V Operation)



Figure 4.9. Si88244 Typical V_{DDA} Supply Current vs. Data Rate (5 and 3.3 V Operation)



Figure 4.10. Si88244 Typical V_{DDB} Supply Current vs. Data Rate (5 and 3.3 V Operation)



Figure 4.11. Propagation Delay vs. Temperature



Figure 4.12. Efficiency vs. Load Current over Temperature (3.3 to 3.3 V)



Figure 4.13. Efficiency vs. Load Current over Temperature (3.3 to 5.0 V)



Figure 4.14. Efficiency vs. Load Current over Temperature (5.0 to 3.3 V)



Figure 4.15. Efficiency vs. Load Current over Temperature (5.0 to 5.0 V)



Figure 4.16. Efficiency vs. Load Current over Temperature (24 V to 5 V)



Figure 4.17. Efficiency vs. Load Current over Temperature (24 V to 3.3 V)



Figure 4.18. Efficiency vs. Load Current over Temperature (12 V to 5 V)



Figure 4.19. Efficiency vs. Load Current over Temperature (7 V to 24 V)



Figure 4.20. 24 V-5 V VOUT Startup vs. Time, No Load Current



Figure 4.21. 24 V-5 V VOUT Startup vs. Time, 50 mA Load Current



Figure 4.22. 24 V-5 V VOUT Startup vs. Time, 400 mA Load Current



Figure 4.23. 5 V-5 V VOUT Startup vs. Time (No Load)



Figure 4.24. 5 V-5 V VOUT Startup vs. Time (50 mA Load Current)



Figure 4.25. 5 V-5 V VOUT Startup vs. Time (400 mA Load Current)



Figure 4.26. 24 V-5 V VOUT Load Transient Response (10% to 90% Load)



Figure 4.27. 5 V-5 V VOUT Load Transient Response (10% to 90% Load)



Figure 4.28. Typical I-V Curve for VREGA/B

5. Electrical Specifications

Table 5.1. Recommended Operating Conditions

| Parameter | Symbol | Min | Typ | Max | Unit |
|--|--------|-----|-----|-----|------|
| Ambient Operating Temperature ¹ | T_A | -40 | 25 | 125 | °C |
| Power Input Voltage | VDDP | 3.0 | — | 5.5 | V |
| Supply Voltage | VDDA | 3.0 | — | 5.5 | V |
| | VDDB | 3.0 | — | 5.5 | V |

Note:

- The maximum ambient temperature is dependent on data frequency, output loading, number of operating channels, and supply voltage.

Table 5.2. Electrical Characteristics¹

$V_{IN} = 24\text{ V}$; $V_{DDA} = 4.3\text{ V}$ (see [Figure 5.3 Measurement Circuit for Converter Efficiency and Regulation for Si884xx, Si886xx on page 32](#)) for all Si8844x/64x; $V_{DDA} = V_{DDP} = 3.0\text{ to }5.5\text{ V}$ (see [Figure 5.2 Measurement Circuit for Converter Efficiency and Regulation for Si882xx, Si883xx on page 32](#)) for all Si8824x/34x; $T_A = -40\text{ to }125\text{ °C}$ unless otherwise noted

| Parameter | Symbol | Test Condition | Min | Typ | Max | Unit |
|--|--------------|---|-------|------|-------|------|
| DC/DC Converter | | | | | | |
| Switching Frequency Si8824x, Si8844x | FSW | | 225 | 250 | 275 | kHz |
| Switching Frequency Si8834x, Si8864x | FSW | $R_{FSW} = 23.3\text{ k}\Omega$ $FSW = 1025.5/(R_{FSW} \times CSS)$ $CSS = 220\text{ nF}$ (see Figure 3.6 Si886xx Block Diagram: 24 V Input to 5 V Output on page 14) (1% tolerance on BOM) | 180 | 200 | 220 | kHz |
| | | $R_{FSW} = 9.3\text{ k}\Omega$ $FSW = 1025.5/(R_{FSW} \times CSS)$ $CSS = 220\text{ nF}$ (see Figure 3.6 Si886xx Block Diagram: 24 V Input to 5 V Output on page 14) (1% tolerance on BOM) | 450 | 500 | 550 | kHz |
| | | $R_{FSW} = 5.18\text{ k}\Omega$, $CSS = 220\text{ nF}$ (see Figure 3.6 Si886xx Block Diagram: 24 V Input to 5 V Output on page 14) | 810 | 900 | 990 | kHz |
| VSNS voltage | VSNS | ILOAD = 0 A | 1.002 | 1.05 | 1.097 | V |
| VSNS current offset | I_{offset} | | -500 | — | 500 | nA |

| Parameter | Symbol | Test Condition | Min | Typ | Max | Unit |
|---|--|--|-----|--|-----|--------|
| Output Voltage Accuracy ² | | See Figure 5.2 Measurement Circuit for Converter Efficiency and Regulation for Si882xx, Si883xx on page 32 ILOAD = 0 mA | -5 | — | +5 | % |
| Line Regulation | $\frac{\Delta V_{OUT}(\text{line})}{\Delta V_{DDP}}$ | See Figure 5.2 Measurement Circuit for Converter Efficiency and Regulation for Si882xx, Si883xx on page 32 ILOAD = 50 mA VDDP varies from 4.5 to 5.5 V | — | 1 | — | mV/V |
| Load Regulation | $\frac{\Delta V_{OUT}(\text{load})}{V_{OUT}}$ | See Figure 5.2 Measurement Circuit for Converter Efficiency and Regulation for Si882xx, Si883xx on page 32 ILOAD = 50 to 400 mA | — | 0.1 | — | % |
| Output Voltage Ripple Si8824x, Si8834x Si8844x, Si8864x | | ILOAD = 100 mA See Figure 5.2 Measurement Circuit for Converter Efficiency and Regulation for Si882xx, Si883xx on page 32 See Figure 5.3 Measurement Circuit for Converter Efficiency and Regulation for Si884xx, Si886xx on page 32 | — | 100 | — | mV p-p |
| Turn-on overshoot | $\Delta V_{OUT}(\text{start})$ | See Figure 5.2 Measurement Circuit for Converter Efficiency and Regulation for Si882xx, Si883xx on page 32 CIN = COUT = 0.1 μ F in parallel with 10 μ F, ILOAD = 0 A | — | 2 | — | % |
| Continuous Output Current Si8824x, Si8834x 5.0 V to 5.0 V 3.3 V to 3.3 V 3.3 V to 5.0 V 5.0 V to 3.3 V Si8844x, Si8864x 24.0 to 5.0 V 24.0 to 3.0 V | ILOAD(max) | See Figure 5.2 Measurement Circuit for Converter Efficiency and Regulation for Si882xx, Si883xx on page 32 See Figure 5.3 Measurement Circuit for Converter Efficiency and Regulation for Si884xx, Si886xx on page 32 | — | 400 400 250 550 1000 1500 | — | mA |
| Cycle-by-cycle average current limit Si8824x, Si8834x | ILIM | See Figure 5.2 Measurement Circuit for Converter Efficiency and Regulation for Si882xx, Si883xx on page 32 Output short circuited | — | 3 | — | A |

| Parameter | Symbol | Test Condition | Min | Typ | Max | Unit |
|--|--------------------|--|-----|----------|-----|---------|
| No Load Supply Current IDDP Si8824x, Si8834x | IDDPQ_DCD C3 | See Figure 5.2 Measurement Circuit for Converter Efficiency and Regulation for Si882xx, Si883xx on page 32 VDDP = VDDA = 5 V | — | 30 | — | mA |
| No Load Supply Current IDDA Si8824x, Si8834x | ID- DAQ_DCDC4 | See Figure 5.2 Measurement Circuit for Converter Efficiency and Regulation for Si882xx, Si883xx on page 32 VDDP = VDDA = 5 V | — | 5.7 | — | mA |
| No Load Supply Current IDDP Si8844x, Si8864x | IDDPQ_DCD C3 | See Figure 5.3 Measurement Circuit for Converter Efficiency and Regulation for Si884xx, Si886xx on page 32 VIN = 24 V | — | 0.8 | — | mA |
| No Load Supply Current IDDA Si8844x, Si8864x | ID- DAQ_DCDC4 | See Figure 5.3 Measurement Circuit for Converter Efficiency and Regulation for Si884xx, Si886xx on page 32 VIN=24V | — | 5.8 | — | mA |
| Peak Efficiency Si8824x, Si8834x Si8844x, Si8864x | η | See Figure 5.2 Measurement Circuit for Converter Efficiency and Regulation for Si882xx, Si883xx on page 32, Figure 5.3 Measurement Circuit for Converter Efficiency and Regulation for Si884xx, Si886xx on page 32 | — | 78 83 | — | % |
| Voltage Regulator Reference Voltage Si8844x, Si8864x | VREGA, VREGB | I _{REG} = 600 μ A See Figure 4.15 Efficiency vs. Load Current over Temperature (5.0 to 5.0 V) on page 21 for typical I-V curve | — | 4.8 | — | V |
| VREG tempco | K _{TVREG} | | — | -0.4 | — | mV/°C |
| VREG input current | I _{REG} | | 350 | — | 950 | μ A |
| Soft Start Time, Full Load Si8824x, Si8844x Si8834x, Si8864x | t _{SST} | See Figures Figure 4.20 24 V–5 V V _{OUT} Startup vs. Time, No Load Current on page 22 through Figure 4.25 5 V–5 V V _{OUT} Startup vs. Time (400 mA Load Current) on page 23 for typical soft start times over load conditions. | — | 25 50 | — | ms |
| Restart Delay from fault event | t _{OTP} | | — | 21 | — | s |
| Digital Isolator | | | | | | |
| VDD Undervoltage Threshold | VDDUV+ | VDDA, VDDB rising | — | 2.7 | — | V |
| VDD Undervoltage Threshold | VDDUV– | VDDA, VDDB falling | — | 2.6 | — | V |

| Parameter | Symbol | Test Condition | Min | Typ | Max | Unit |
|---|--------------------|-------------------------|--|------|------|------|
| VDD Undervoltage Hysteresis | VDD _{HYS} | | — | 100 | — | mV |
| Positive-Going Input Threshold | V _{T+} | All inputs rising | — | 1.7 | — | V |
| Negative-Going Input Threshold | V _{T-} | All inputs falling | — | 1.2 | — | V |
| Input Hysteresis | V _{HYS} | | — | 0.4 | — | V |
| High Level Input Voltage | V _{IH} | | 2.0 | — | — | V |
| Low Level Input Voltage | V _{IL} | | — | — | 0.8 | V |
| High Level Output Voltage | V _{OH} | I _{oh} = -4 mA | V _{DDA} , V _{DDB} - 0.4 | — | — | V |
| Low Level Output Voltage | V _{OL} | I _{ol} = 4 mA | — | — | 0.4 | V |
| Input Leakage Current | I _L | | -10 | — | +10 | μA |
| Output Impedance | Z _O | | — | 50 | — | Ω |
| Supply Current, C_{LOAD} = 15 pF | | | | | | |
| DC, VDDx = 3.3 V ± 10% | | | | | | |
| Si88x40ED | | | | | | |
| VDDA | | All inputs = 0 | 7.5 | 10.5 | 13.5 | mA |
| VDDB | | All inputs = 0 | 3.5 | 5.5 | 7.5 | |
| VDDA | | All inputs = 1 | 1.5 | 4.5 | 7.8 | |
| VDDB | | All inputs = 1 | 2.5 | 4.5 | 6.5 | |
| Si88x41ED | | | | | | |
| VDDA | | All inputs = 0 | 6.7 | 9.7 | 12.7 | mA |
| VDDB | | All inputs = 0 | 5.0 | 7.0 | 9.0 | |
| VDDA | | All inputs = 1 | 1.5 | 4.5 | 7.8 | |
| VDDB | | All inputs = 1 | 2.5 | 4.5 | 6.5 | |
| Si88x42ED | | | | | | |
| VDDA | | All inputs = 0 | 5.2 | 8.2 | 11.2 | mA |
| VDDB | | All inputs = 0 | 6.1 | 8.1 | 10.1 | |
| VDDA | | All inputs = 1 | 1.5 | 4.5 | 7.8 | |
| VDDB | | All inputs = 1 | 2.5 | 4.5 | 6.5 | |
| Si88x43ED | | | | | | |
| VDDA | | All inputs = 0 | 3.7 | 6.7 | 9.7 | mA |
| VDDB | | All inputs = 0 | 7.5 | 9.5 | 11.5 | |
| VDDA | | All inputs = 1 | 1.5 | 4.5 | 7.8 | |
| VDDB | | All inputs = 1 | 2.5 | 4.5 | 6.5 | |

| Parameter | Symbol | Test Condition | Min | Typ | Max | Unit |
|-----------|--------|----------------|-----|------|------|------|
| Si88x44ED | | | | | | |
| VDDA | | All inputs = 0 | 1.9 | 4.9 | 7.9 | mA |
| VDDB | | All inputs = 0 | 9.0 | 11.0 | 13.0 | |
| VDDA | | All inputs = 1 | 1.5 | 4.5 | 7.8 | |
| VDDB | | All inputs = 1 | 2.5 | 4.5 | 6.5 | |
| Si88x40BD | | | | | | |
| VDDA | | All inputs = 0 | 1.5 | 4.5 | 7.8 | mA |
| VDDB | | All inputs = 0 | 2.5 | 4.5 | 6.5 | |
| VDDA | | All inputs = 1 | 7.5 | 10.5 | 13.5 | |
| VDDB | | All inputs = 1 | 3.5 | 5.5 | 7.5 | |
| Si88x41BD | | | | | | |
| VDDA | | All inputs = 0 | 1.5 | 4.5 | 7.8 | mA |
| VDDB | | All inputs = 0 | 2.5 | 4.5 | 6.5 | |
| VDDA | | All inputs = 1 | 6.7 | 9.7 | 12.7 | |
| VDDB | | All inputs = 1 | 5.0 | 7.0 | 9.0 | |
| Si88x42BD | | | | | | |
| VDDA | | All inputs = 0 | 1.5 | 4.5 | 7.8 | mA |
| VDDB | | All inputs = 0 | 2.5 | 4.5 | 6.5 | |
| VDDA | | All inputs = 1 | 5.2 | 8.2 | 11.2 | |
| VDDB | | All inputs = 1 | 6.1 | 8.1 | 10.1 | |
| Si88x43BD | | | | | | |
| VDDA | | All inputs = 0 | 1.5 | 4.5 | 7.8 | mA |
| VDDB | | All inputs = 0 | 2.5 | 4.5 | 6.5 | |
| VDDA | | All inputs = 1 | 3.7 | 6.7 | 9.7 | |
| VDDB | | All inputs = 1 | 7.5 | 9.5 | 11.5 | |
| Si88x44BD | | | | | | |
| VDDA | | All inputs = 0 | 1.5 | 4.5 | 7.8 | mA |
| VDDB | | All inputs = 0 | 2.5 | 4.5 | 6.5 | |
| VDDA | | All inputs = 1 | 1.9 | 4.9 | 7.9 | |
| VDDB | | All inputs = 1 | 9.0 | 11.0 | 13.0 | |

| Parameter | Symbol | Test Condition | Min | Typ | Max | Unit |
|---|--------|----------------|------|------|------|------|
| Supply Current, C_{LOAD} = 15 pF | | | | | | |
| DC, VDDx = 5 V ± 10% | | | | | | |
| Si88x40ED | | | | | | |
| VDDA | | All inputs = 0 | 10.3 | 13.3 | 16.3 | mA |
| VDDB | | All inputs = 0 | 3.8 | 5.8 | 7.8 | |
| VDDA | | All inputs = 1 | 4.0 | 7.0 | 10.0 | |
| VDDB | | All inputs = 1 | 2.8 | 4.8 | 6.8 | |
| Si88x41ED | | | | | | |
| VDDA | | All inputs = 0 | 9.0 | 12.0 | 15.0 | mA |
| VDDB | | All inputs = 0 | 5.0 | 7.0 | 9.0 | |
| VDDA | | All inputs = 1 | 4.0 | 7.0 | 10.0 | |
| VDDB | | All inputs = 1 | 2.8 | 4.8 | 6.8 | |
| Si88x42ED | | | | | | |
| VDDA | | All inputs = 0 | 7.8 | 10.8 | 12.8 | mA |
| VDDB | | All inputs = 0 | 6.3 | 8.3 | 10.3 | |
| VDDA | | All inputs = 1 | 4.0 | 7.0 | 10.0 | |
| VDDB | | All inputs = 1 | 2.8 | 4.8 | 6.8 | |
| Si88x43ED | | | | | | |
| VDDA | | All inputs = 0 | 6.5 | 9.5 | 12.5 | mA |
| VDDB | | All inputs = 0 | 7.5 | 9.5 | 11.5 | |
| VDDA | | All inputs = 1 | 4.0 | 7.0 | 10.0 | |
| VDDB | | All inputs = 1 | 2.8 | 4.8 | 6.8 | |
| Si88x44ED | | | | | | |
| VDDA | | All inputs = 0 | 4.3 | 7.3 | 10.3 | mA |
| VDDB | | All inputs = 0 | 9.0 | 11.0 | 13.0 | |
| VDDA | | All inputs = 1 | 4.0 | 7.0 | 10.0 | |
| VDDB | | All inputs = 1 | 2.8 | 4.8 | 6.8 | |
| Si88x40BD | | | | | | |
| VDDA | | All inputs = 0 | 4.0 | 7.0 | 10.0 | mA |
| VDDB | | All inputs = 0 | 2.8 | 4.8 | 6.8 | |
| VDDA | | All inputs = 1 | 10.3 | 13.3 | 16.3 | |
| VDDB | | All inputs = 1 | 3.8 | 5.8 | 7.8 | |

| Parameter | Symbol | Test Condition | Min | Typ | Max | Unit |
|-------------------------------|-----------|---|------|------|------|------|
| Si88x41BD | | | | | | |
| VDDA | | All inputs = 0 | 4.0 | 7.0 | 10.0 | mA |
| VDDB | | All inputs = 0 | 2.8 | 4.8 | 6.8 | |
| VDDA | | All inputs = 1 | 9.0 | 12.0 | 15.0 | |
| VDDB | | All inputs = 1 | 5.0 | 7.0 | 9.0 | |
| Si88x42BD | | | | | | |
| VDDA | | All inputs = 0 | 4.0 | 7.0 | 10.0 | mA |
| VDDB | | All inputs = 0 | 2.8 | 4.8 | 6.8 | |
| VDDA | | All inputs = 1 | 7.8 | 10.8 | 12.8 | |
| VDDB | | All inputs = 1 | 6.3 | 8.3 | 10.3 | |
| Si88x43BD | | | | | | |
| VDDA | | All inputs = 0 | 4.0 | 7.0 | 10.0 | mA |
| VDDB | | All inputs = 0 | 2.8 | 4.8 | 6.8 | |
| VDDA | | All inputs = 1 | 6.5 | 9.5 | 12.5 | |
| VDDB | | All inputs = 1 | 7.5 | 9.5 | 11.5 | |
| Si88x44BD | | | | | | |
| VDDA | | All inputs = 0 | 4.0 | 7.0 | 10.0 | mA |
| VDDB | | All inputs = 0 | 2.8 | 4.8 | 6.8 | |
| VDDA | | All inputs = 1 | 4.3 | 7.3 | 10.3 | |
| VDDB | | All inputs = 1 | 9.0 | 11.0 | 13.0 | |
| Timing Characteristics | | | | | | |
| Data Rate | | | 0 | — | 100 | Mbps |
| Minimum Pulse Width | | | 10 | — | — | ns |
| Propagation Delay | t_{PHL} | See Figure 5.1 Propagation Delay Timing for Digital Channels on page 31 VDDx = 3.3 V | 12.0 | 17.0 | 22.0 | ns |
| Propagation Delay | t_{PLH} | See Figure 5.1 Propagation Delay Timing for Digital Channels on page 31 VDDx = 3.3 V | 11.0 | 15.0 | 20.0 | ns |
| Propagation Delay | t_{PHL} | See Figure 5.1 Propagation Delay Timing for Digital Channels on page 31 VDDx = 5.0 V | 13.0 | 18.0 | 23.0 | ns |
| Propagation Delay | t_{PLH} | See Figure 5.1 Propagation Delay Timing for Digital Channels on page 31 VDDx = 5.0 V | 10.0 | 13.0 | 18.0 | ns |

| Parameter | Symbol | Test Condition | Min | Typ | Max | Unit |
|---|----------------|---|-----|-----|------|-------------------|
| Pulse Width Distortion $ t_{PLH} - t_{PHL} $ | PWD | See Figure 5.1 Propagation Delay Timing for Digital Channels on page 31 VDDx = 3.3 V | — | 2.5 | 5.0 | ns |
| Pulse Width Distortion $ t_{PLH} - t_{PHL} $ | PWD | See Figure 5.1 Propagation Delay Timing for Digital Channels on page 31 VDDx = 5.0 V | — | 4.5 | 7.0 | ns |
| Propagation Delay Skew ⁶ | $t_{PSK(P-P)}$ | | — | 3.0 | 10.0 | ns |
| Channel-Channel Skew | t_{PSK} | | — | 2.0 | 4.0 | ns |
| Output Rise Time | t_r | $C_{LOAD} = 15 \text{ pF}$ | — | 2.5 | — | ns |
| Output Fall Time | t_f | $C_{LOAD} = 15 \text{ pF}$ | — | 2.5 | — | ns |
| Common Mode Transient Immunity | CMTI | $V_I = V_{DDx} \text{ or } 0 \text{ V}$ $V_{CM} = 1500 \text{ V}$ See Figure 5.4 Common-Mode Transient Immunity Test Circuit on page 33 | 40 | 100 | — | kV/ μs |
| Startup Time ⁷ | t_{SU} | | — | 55 | — | μs |

Note:

- Over recommended operating conditions as noted in [Table 5.1 Recommended Operating Conditions](#) on page 24.
- $V_{OUT} = V_{SNS} \times (1 + R1/R2) + R1 \times I_{offset}$
- VDDP current needed for dc-dc circuits.
- VDDA current needed for dc-dc circuits.
- The nominal output impedance of an isolator driver channel is approximately 50Ω , $\pm 40\%$, which is a combination of the value of the on-chip series termination resistor and channel resistance of the output driver FET. When driving loads where transmission line effects will be a factor, output pins should be appropriately terminated with controlled impedance PCB traces.
- $t_{PSK(P-P)}$ is the magnitude of the difference in propagation delay times measured between different units operating at the same supply voltages, load, and ambient temperature.
- Start-up time is the time period from when the UVLO threshold is exceeded to valid data at the output.



Figure 5.1. Propagation Delay Timing for Digital Channels



Figure 5.2. Measurement Circuit for Converter Efficiency and Regulation for Si882xx, Si883xx



Figure 5.3. Measurement Circuit for Converter Efficiency and Regulation for Si884xx, Si886xx



Figure 5.4. Common-Mode Transient Immunity Test Circuit

Table 5.3. Regulatory Information^{1, 2}

| |
|---|
| CSA |
| The Si88xx is certified under CSA Component Acceptance Notice 5A. For more details, see Master Contract Number 232873. |
| 60950-1: Rated up to 600 V _{RMS} reinforced insulation working voltage; up to 1000 V _{RMS} basic insulation working voltage. |
| VDE |
| The Si88xx is certified according to VDE 0884-10. For more details, see certificate 40018443. |
| VDE 0884-10: Up to 891 V _{peak} for basic insulation working voltage. |
| UL |
| The Si88xx is certified under UL1577 component recognition program. For more details, see File E257455. |
| Rated up to 5000 V _{RMS} isolation voltage for basic protection. |
| CQC |
| The Si88xx is certified under GB4943.1-2011. |
| Rated up to 600 V _{RMS} reinforced insulation working voltage; up to 1000 V _{RMS} basic insulation working voltage. |
| Note: |
| 1. Regulatory Certifications apply to 3.75 and 5.0 kV _{RMS} rated devices, which are production tested to 4.5 and 6.0 kV _{RMS} for 1 sec, respectively. |
| 2. All certifications are pending. |

Table 5.4. Insulation and Safety-Related Specifications

| Parameter | Symbol | Test Condition | Value | Unit |
|--|-----------------|----------------|--------------------------|------|
| | | | WB SOIC-20 WB SOIC-24 | |
| Nominal External Air Gap (Clearance) | CLR | | 8.0 ¹ | mm |
| Nominal External Tracking (Creepage) | CPG | | 8.0 ¹ | mm |
| Minimum Internal Gap (Internal Clearance) | DTI | | 0.014 | mm |
| Tracking Resistance | PTI or CTI | IEC60112 | 600 | V |
| Erosion Depth | ED | | 0.019 | mm |
| Resistance (Input-Output) ² | R _{IO} | | 10 ¹² | Ω |
| Capacitance (Input-Output) ² | C _{IO} | f = 1 MHz | 1.4 | pF |
| Input Capacitance ³ | C _I | | 4.0 | pF |

Note:

1. The values in this table correspond to the nominal creepage and clearance values. VDE certifies the clearance and creepage limits as 8.5 mm minimum for the WB SOIC-20 and WB SOIC-24 packages. UL does not impose a clearance and creepage minimum for component-level certifications. CSA certifies the clearance and creepage limits as 7.6 mm minimum for the WB SOIC-20 and WB SOIC-24 packages.
2. To determine resistance and capacitance, the Si88xx is converted into a 2-terminal device.
3. Measured from input to ground.

Table 5.5. IEC 60664-1 Ratings

| Parameter | Test Condition | Specification |
|-----------------------------|---|--------------------------|
| | | WB SOIC-20 WB SOIC-24 |
| Basic Isolation Group | Material Group | I |
| Installation Classification | Rate Mains Voltages <150 V _{RMS} | I-IV |
| | Rate Mains Voltages <300 V _{RMS} | I-IV |
| | Rate Mains Voltages <400 V _{RMS} | I-III |
| | Rate Mains Voltages <600 V _{RMS} | I-III |

Table 5.6. VDE 0884-10 Insulation Characteristics¹

| Parameter | Symbol | Test Condition | Characteristic | Unit |
|--|-------------------|---|--------------------------|--------|
| | | | WB SOIC-20 WB SOIC-24 | |
| Maximum Working Insulation Voltage | V _{IORM} | | 891 | V peak |
| Input to Output Test Voltage | V _{PR} | Method b1 (V _{IORM} × 1.875 = V _{PR} , 100% Production Test, t _m = 1 sec, Partial Discharge < 5 pC) | 1671 | V peak |
| Transient Overvoltage | V _{IOTM} | t = 60 sec | 6000 | V peak |
| Surge Voltage | V _{IOSM} | Tested per IEC 60065 with surge voltage of 1.2 μs/50 μs Tested with 4000 V | 3077 | V peak |
| Pollution Degree (DIN VDE 0110, Table 1) | | | 2 | |
| Insulation Resistance at T _S , V _{IO} = 500 V | R _S | | >10 ⁹ | Ω |

Note:

- Maintenance of the safety data is ensured by protective circuits. The Si88xx provides a climate classification of 40/125/21.

Table 5.7. IEC Safety Limiting Values¹

| Parameter | Symbol | Test Condition | WB SOIC-20, WB SOIC-24 | Unit |
|--------------------------|--------|---|------------------------|------|
| Safety Temperature | T_S | | 150 | °C |
| Safety Input Current | I_S | $\theta_{JA} = 55 \text{ }^\circ\text{C/W}$ (WB SOIC-20), $V_{DDA} = 5.5 \text{ V}$, $T_J = 150 \text{ }^\circ\text{C}$, $T_A = 25 \text{ }^\circ\text{C}$ | 413 | mA |
| Device Power Dissipation | P_D | | 2.27 | W |

Note:

1. Maximum value allowed in the event of a failure. Refer to the thermal derating curve in [Figure 5.5 WB SOIC-20/24 Thermal Derating Curve \(Dependence of Safety Limiting Values per VDE\)](#) on page 36.

Table 5.8. Thermal Characteristics

| Parameter | Symbol | WB SOIC-20, WB SOIC-24 | Unit |
|---------------------------------------|---------------|------------------------|------|
| IC Junction-to-Air Thermal Resistance | θ_{JA} | 55 | °C/W |



Figure 5.5. WB SOIC-20/24 Thermal Derating Curve (Dependence of Safety Limiting Values per VDE)

Table 5.9. Absolute Maximum Ratings¹

| Parameter | Symbol | Min | Max | Unit |
|---------------------------|------------------------|------|------|------|
| Storage Temperature | T_{STG} | -65 | +150 | °C |
| Junction Temperature | T_J | — | +150 | °C |
| Input-side Supply Voltage | V_{DDA} V_{DDP} | -0.6 | 6.0 | V |

| Parameter | Symbol | Min | Max | Unit |
|--|------------------|------|-----------|------------------|
| Output supply | VDDB | -0.6 | 6.0 | V |
| Voltage on any Pin with respect to Ground | VIN | -0.5 | VDD + 0.5 | V |
| Output Drive Current per Channel | I _O | | 10 | mA |
| Input Current for VREGA, VREGB | I _{REG} | — | 1 | mA |
| Lead Solder Temperature (10 s) | | — | 260 | °C |
| ESD per AEC-Q100 | HBM | — | 4 | kV |
| | CDM | — | 2 | kV |
| Maximum Isolation (Input to Output) (1 sec) WB SOIC-20, WB SOIC-24 | | — | 6500 | V _{RMS} |
| Note: | | | | |
| 1. Permanent device damage may occur if the absolute maximum ratings are exceeded. Functional operation should be restricted to the conditions as specified in the operational sections of this data sheet. Exposure to absolute maximum rating conditions for extended periods may affect device reliability. | | | | |

5.1 Calculating Total Current Consumption

For calculating dynamic supply current, use the following guidelines:

The dynamic current is calculated as follows:

$$IDD(ac) = (C_L) \times (V) \times \left(\frac{D}{2}\right) \times 1E - 3$$

Where

IDD(ac) is the dynamic component of current, per output channel, in mA

D is the data-rate of that channel, in Mbps

C_L is the load capacitance connected to the output, in pF

V is the VDD on the output side, in Volts

For example, for the Si88x42ED-IS, the total current can be calculated as follows:

The average DC IDDA/B is the average of the DC current values at input 0 and input 1, for VDDA and VDDB respectively (max values used), as stated in the table above for Si88x42ED.

| CL, pF | VDD, V | Data-rate, Mbps | IDD(ac), per output channel, mA | Total IDDA(ac), mA | Total IDDB(ac), mA | Average DC IDDA, mA | Average DC IDDB, mA | Total IDDA, mA | Total IDDB, mA |
|--------|--------|-----------------|---------------------------------|--------------------|--------------------|---------------------|---------------------|----------------|----------------|
| 20 | 3.3 | 10 | 0.33 | 0.66 | 0.66 | 9.35 | 8.3 | 10.01 | 8.96 |

6. Pin Descriptions

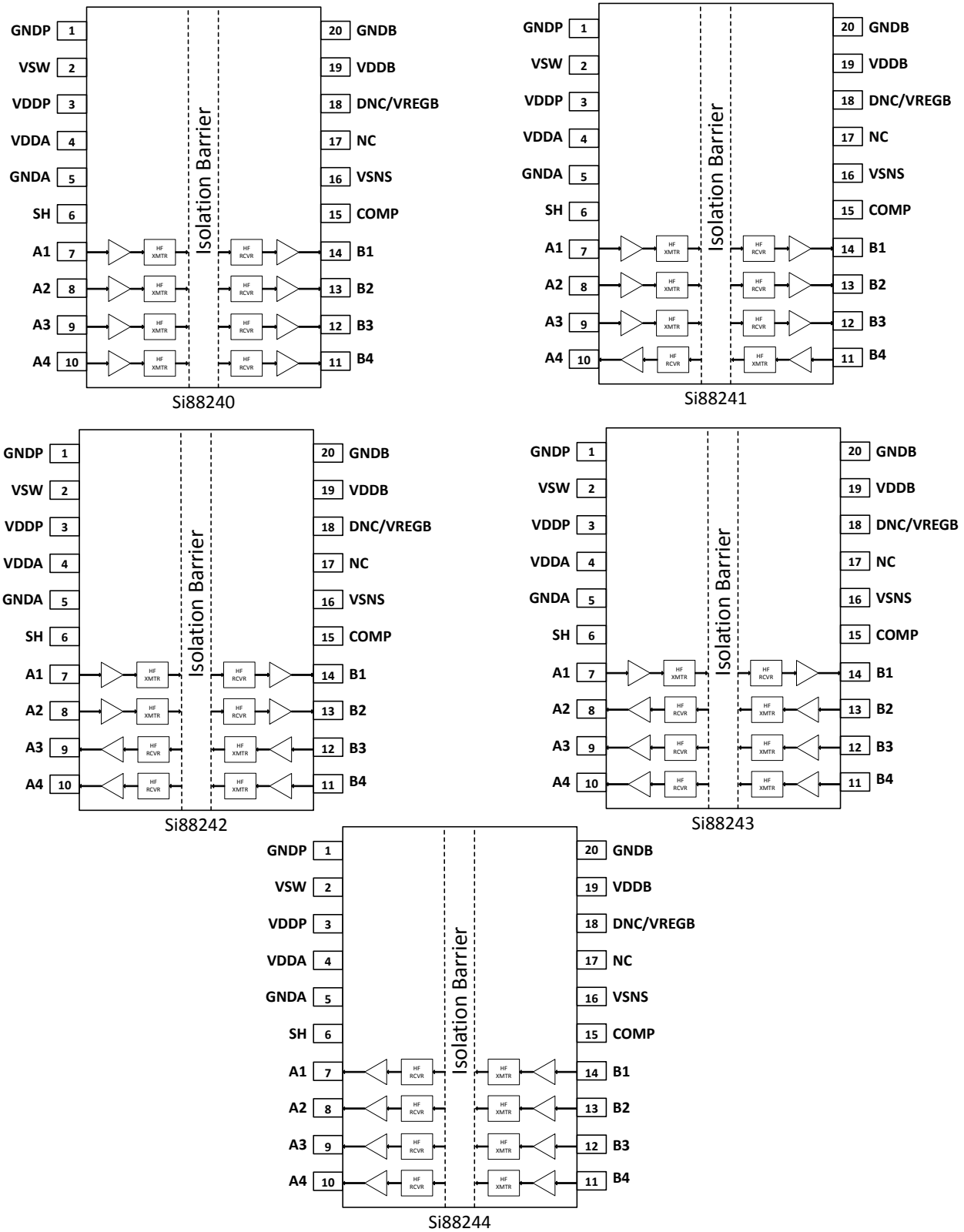

Figure 6.1. Si8824x Pin Configurations



Figure 6.2. Si8834x Pinout Diagrams



Figure 6.3. Si8844x Pinout Diagrams

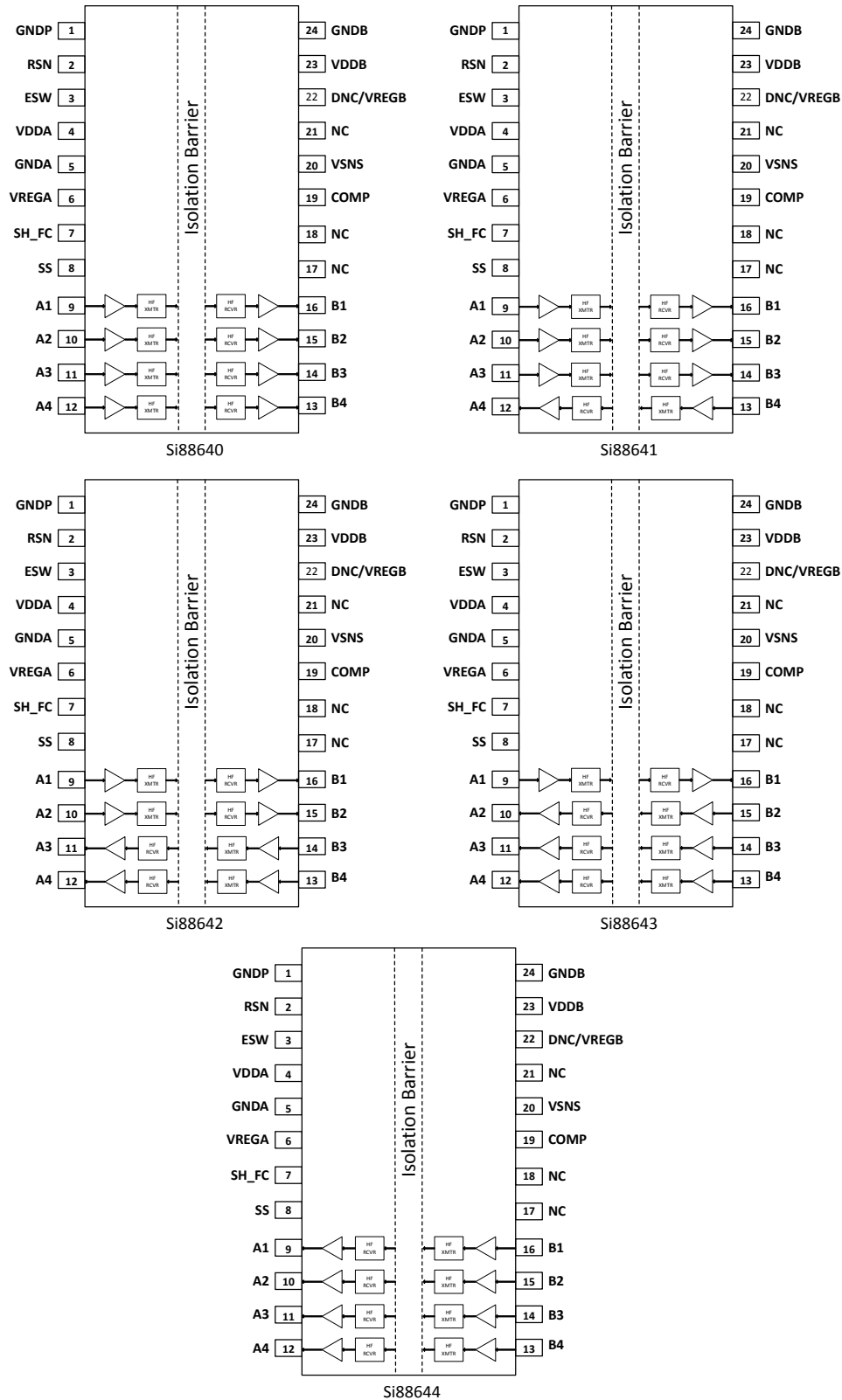

Figure 6.4. Si8864x Pinout Diagrams

Table 6.1. Si88x4x Pin Descriptions

| Pin Name | Description |
|-----------------------------------|--|
| DC-DC Input Side | |
| VDDP | Power stage primary power supply. |
| VREGA | Voltage reference output for external voltage regulator pin. |
| GNDP | Power stage ground. |
| ESW | Power stage external switch driver output. |
| VSW | Power stage internal switch output. |
| SS | Soft startup control. |
| SH, SH_FC | Shutdown and Switch frequency control. |
| RSN | Power stage current sense input. |
| DC-DC Output Side | |
| VSNS | Power stage feedback input. |
| COMP | Power stage compensation. |
| DNC/VREGB | Voltage reference output for external voltage regulator pin. This pin has a Zener connected internally. Use this pin as reference only when output voltage from dc-dc is > 5.5 V. If output voltage is ≤ 5.5V, this pin should be read as DNC or Do Not Connect, and should be no connect. |
| NC | No connect; this pin is not connected to the silicon. |
| Digital Isolator VDDA Side | |
| VDDA | Primary side signal power supply. |
| A1–A4 | I/O signal channel 1–4. |
| GND A | Primary side signal ground. |
| Digital Isolator VDDB Side | |
| VDDB | Secondary side signal power supply. |
| B1–B4 | I/O signal channel 1–4. |
| GND B | Secondary side signal ground. |

7. Package Outline: 20-Pin Wide Body SOIC

Figure 7.1 20-Pin Wide Body SOIC on page 43 illustrates the package details for the 20-pin wide-body SOIC package. Table 7.1 20-Pin Wide Body SOIC Package Diagram Dimensions on page 43 lists the values for the dimensions shown in the illustration.

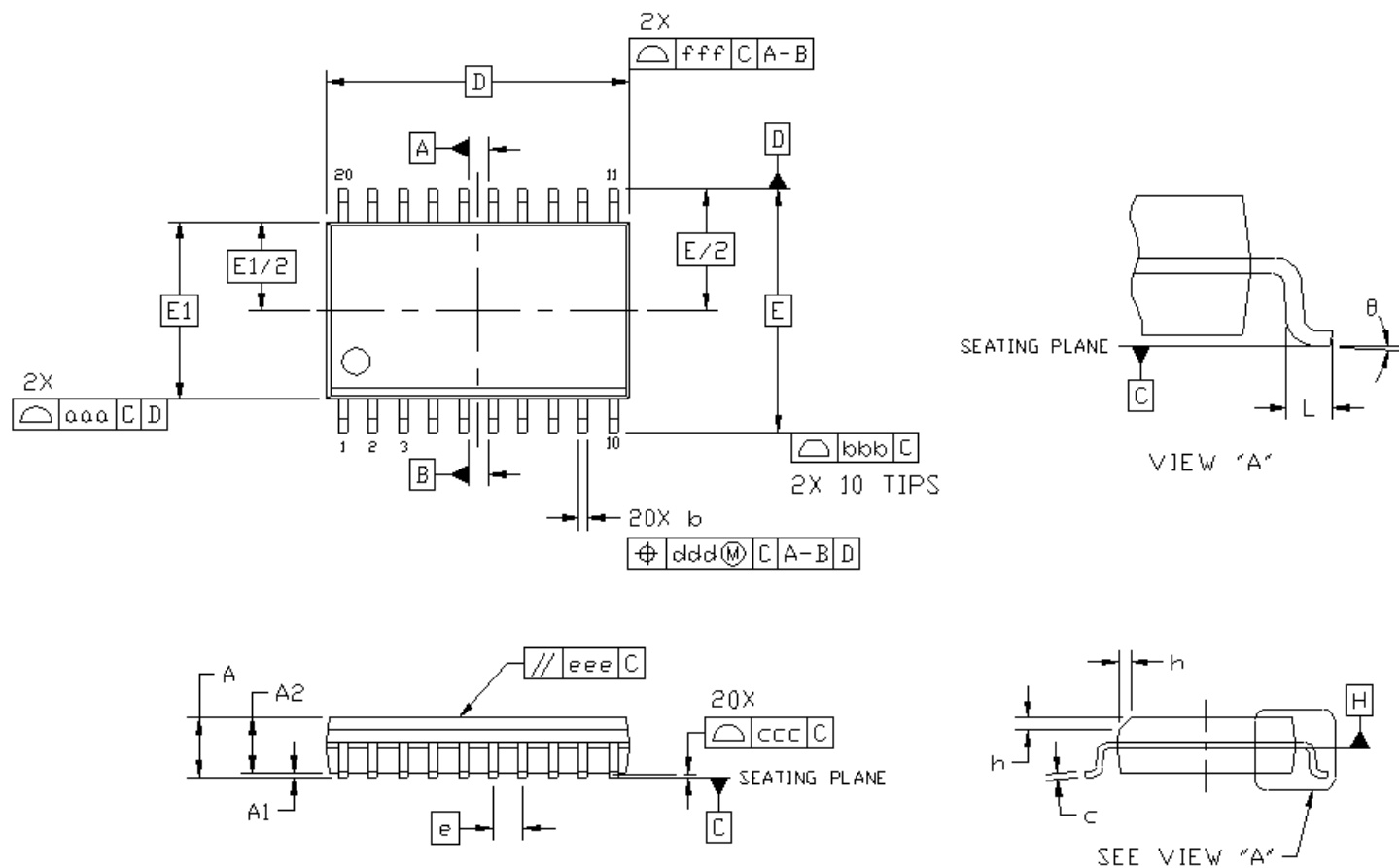

Figure 7.1. 20-Pin Wide Body SOIC

Table 7.1. 20-Pin Wide Body SOIC Package Diagram Dimensions

| Dimension | Min | Max |
|-----------|-----------|------|
| A | — | 2.65 |
| A1 | 0.10 | 0.30 |
| A2 | 2.05 | — |
| b | 0.31 | 0.51 |
| c | 0.20 | 0.33 |
| D | 12.80 BSC | |
| E | 10.30 BSC | |
| E1 | 7.50 BSC | |
| e | 1.27 BSC | |
| L | 0.40 | 1.27 |
| h | 0.25 | 0.75 |
| θ | 0° | 8° |
| aaa | — | 0.10 |

| Dimension | Min | Max |
|-----------|-----|------|
| bbb | — | 0.33 |
| ccc | — | 0.10 |
| ddd | — | 0.25 |
| eee | — | 0.10 |
| fff | — | 0.20 |

Note:

1. All dimensions shown are in millimeters (mm) unless otherwise noted.
2. Dimensioning and Tolerancing per ANSI Y14.5M-1994.
3. This drawing conforms to JEDEC Outline MS-013, Variation AC.
4. Recommended reflow profile per JEDEC J-STD-020C specification for small body, lead-free components.

8. Land Pattern: 20-Pin SOIC

Figure 8.1 20-Pin SOIC PCB Land Pattern on page 45 illustrates the PCB land pattern details for the 20-pin SOIC package. Table 8.1 24-Pin SOIC PCB Land Pattern Dimensions on page 45 lists the values for the dimensions shown in the illustration.



Figure 8.1. 20-Pin SOIC PCB Land Pattern

Table 8.1. 24-Pin SOIC PCB Land Pattern Dimensions

| Dimension | mm |
|-----------|------|
| C1 | 9.40 |
| E | 1.27 |
| X1 | 0.60 |
| Y1 | 1.90 |

Note:

1. This Land Pattern Design is based on IPC-7351 design guidelines for Density Level B (Median Land Protrusion).
2. All feature sizes shown are at Maximum Material Condition (MMC), and a card fabrication tolerance of 0.05 mm is assumed.

9. Package Outline: 24-Pin Wide Body SOIC

Figure 9.1 24-Pin Wide Body SOIC on page 46 illustrates the package details for the 24-pin wide-body SOIC package. Table 9.1 24-Pin Wide Body SOIC Package Diagram Dimensions on page 46 lists the values for the dimensions shown in the illustration.



Figure 9.1. 24-Pin Wide Body SOIC

Table 9.1. 24-Pin Wide Body SOIC Package Diagram Dimensions

| Dimension | Min | Max |
|-----------|-----------|------|
| A | — | 2.65 |
| A1 | 0.10 | 0.30 |
| A2 | 2.05 | — |
| b | 0.31 | 0.51 |
| c | 0.20 | 0.33 |
| D | 15.40 BSC | |
| E | 10.30 BSC | |
| E1 | 7.50 BSC | |
| e | 1.27 BSC | |
| L | 0.40 | 1.27 |
| h | 0.25 | 0.75 |
| θ | 0° | 8° |
| aaa | — | 0.10 |
| bbb | — | 0.33 |

| Dimension | Min | Max |
|-----------|-----|------|
| ccc | — | 0.10 |
| ddd | — | 0.25 |
| eee | — | 0.10 |
| fff | — | 0.20 |

Note:

1. All dimensions shown are in millimeters (mm) unless otherwise noted.
2. Dimensioning and Tolerancing per ANSI Y14.5M-1994.
3. This drawing conforms to JEDEC Outline MS-013, Variation AD.
4. Recommended reflow profile per JEDEC J-STD-020 specification for small body, lead-free components.

10. Land Pattern: 24-Pin SOIC

Figure 10.1 24-Pin SOIC PCB Land Pattern on page 48 illustrates the PCB land pattern details for the 24-pin SOIC package. Table 10.1 24-Pin SOIC PCB Land Pattern Dimensions on page 48 lists the values for the dimensions shown in the illustration.



Figure 10.1. 24-Pin SOIC PCB Land Pattern

Table 10.1. 24-Pin SOIC PCB Land Pattern Dimensions

| Dimension | mm |
|-----------|------|
| C1 | 9.40 |
| E | 1.27 |
| X1 | 0.60 |
| Y1 | 1.90 |

Note:

1. This Land Pattern Design is based on IPC-7351 design guidelines for Density Level B (Median Land Protrusion).
2. All feature sizes shown are at Maximum Material Condition (MMC), and a card fabrication tolerance of 0.05 mm is assumed.

11. Top Markings

11.1 Si88x4x Top Marking (20-Pin Wide Body SOIC)



11.2 Top Marking Explanation (20-Pin Wide Body SOIC)

| | | |
|-----------------|---|--|
| Line 1 Marking: | <p>Base Part Number</p> <p>Ordering Options</p> <p>See Ordering Guide for more information.</p> | <p>Si88x4 = 5 kV rated 4 channel digital isolator with dc-dc converter</p> <p>X = 2, 4</p> <ul style="list-style-type: none"> • 2 = dc-dc shutdown • 4 = External FET <p>Y = Number of reverse channels</p> <p>Z = E, B</p> <ul style="list-style-type: none"> • E = default high • B = default low <p>R = C, D</p> <ul style="list-style-type: none"> • C = 3.75 kV_{RMS} • D = 5 kV_{RMS} isolation rating |
| Line 2 Marking: | <p>YY = Year</p> <p>WW = Workweek</p> | <p>Assigned by the Assembly House. Corresponds to the year and workweek of the mold date.</p> |
| | <p>TTTTTT = Mfg Code</p> | <p>Manufacturing Code from Assembly Purchase Order form.</p> |
| Line 3 Marking: | <p>Circle = 1.5 mm Diameter (Center Justified)</p> | <p>"e4" Pb-Free Symbol</p> |
| | <p>Country of Origin</p> <p>ISO Code Abbreviation</p> | <p>TW = Taiwan</p> |

11.3 Si88x4x Top Marking (24-Pin Wide Body SOIC)

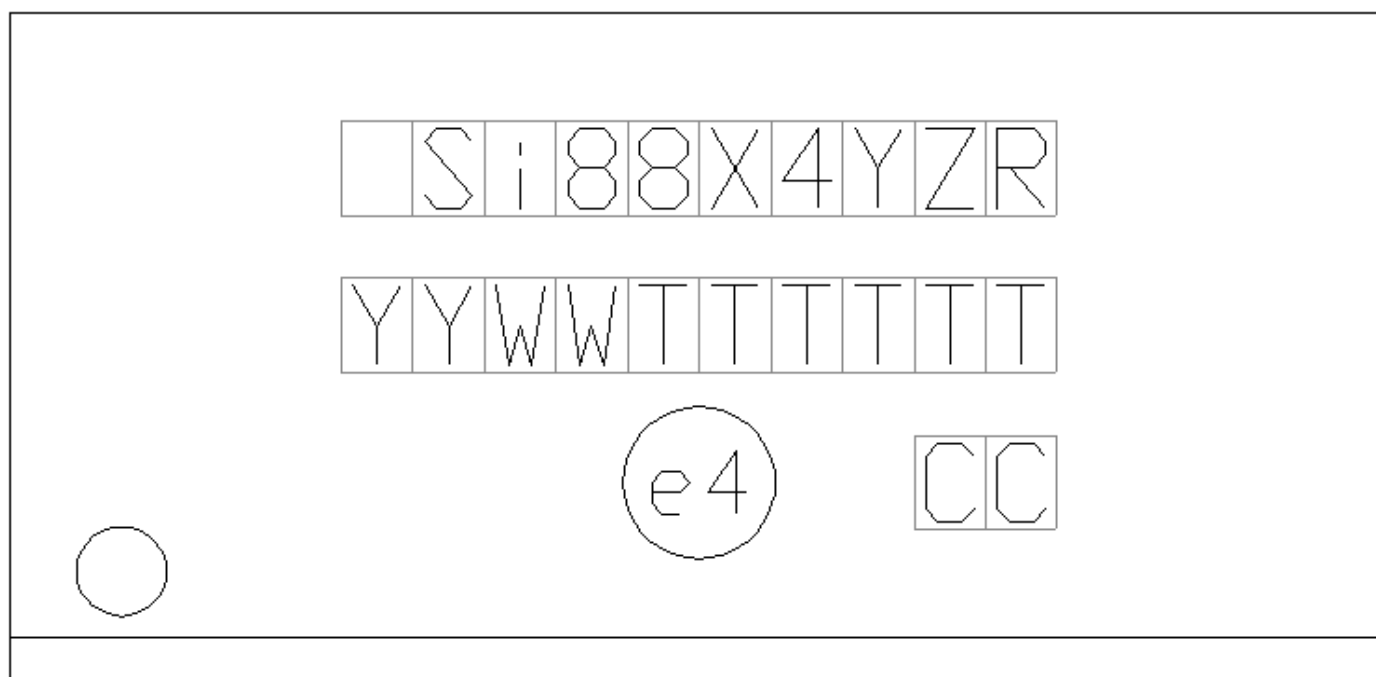

11.4 Top Marking Explanation (24-Pin Wide Body SOIC)

| | | |
|-----------------|--|---|
| Line 1 Marking: | Base Part Number Ordering Options See Ordering Guide for more information. | Si88x4 = 5kV rated 4 channel digital isolator with dc-dc converter X = 3, 6 <ul style="list-style-type: none"> • 3 = Full-featured dc-dc with internal FET • 6 = Full-featured dc-dc with external FET Y = Number of reverse channels Z = E, B <ul style="list-style-type: none"> • E = default high • B = default low R = C, D <ul style="list-style-type: none"> • C = 3.75 kV_{RMS} • D = 5 kV_{RMS} isolation rating |
| Line 2 Marking: | YY = Year WW = Workweek | Assigned by the Assembly House. Corresponds to the year and workweek of the mold date. |
| | TTTTTT = Mfg Code | Manufacturing Code from Assembly Purchase Order form. |
| Line 3 Marking: | Circle = 1.5 mm Diameter (Center Justified) | "e4" Pb-Free Symbol |
| | Country of Origin ISO Code Abbreviation | TW = Taiwan |

12. Revision History

Rev. 1.05

May 2020

- Added Si88642EC-AS to Table 2.2 Ordering Guide for Automotive Grade OPNs

Rev. 1.04

May 2019

- Added Si88342EC-AS to Table 2.2 Ordering Guide for Automotive Grade OPNs

Rev. 1.03

March 2019

- Corrected Transformer Specification table

Rev. 1.02

November 2018

- Updated Transformer Specification table

Rev. 1.01

March 2018

- Added Automotive Grade Ordering Guide
- Updated Ordering Guide Table 2.1
- Updated Transformer Table 3.1
- Updated Spec Table 4.2
- Added section 5.1 (Calculating total current)

Rev. 0.6

August 2015

- Reformatted figures
- Corrected typos
- Added text for clarity



Smart.
Connected.
Energy-Friendly.



Products
www.silabs.com/products



Quality
www.silabs.com/quality



Support and Community
community.silabs.com

Disclaimer

Silicon Labs intends to provide customers with the latest, accurate, and in-depth documentation of all peripherals and modules available for system and software implementers using or intending to use the Silicon Labs products. Characterization data, available modules and peripherals, memory sizes and memory addresses refer to each specific device, and "Typical" parameters provided can and do vary in different applications. Application examples described herein are for illustrative purposes only. Silicon Labs reserves the right to make changes without further notice to the product information, specifications, and descriptions herein, and does not give warranties as to the accuracy or completeness of the included information. Without prior notification, Silicon Labs may update product firmware during the manufacturing process for security or reliability reasons. Such changes will not alter the specifications or the performance of the product. Silicon Labs shall have no liability for the consequences of use of the information supplied in this document. This document does not imply or expressly grant any license to design or fabricate any integrated circuits. The products are not designed or authorized to be used within any FDA Class III devices, applications for which FDA premarket approval is required, or Life Support Systems without the specific written consent of Silicon Labs. A "Life Support System" is any product or system intended to support or sustain life and/or health, which, if it fails, can be reasonably expected to result in significant personal injury or death. Silicon Labs products are not designed or authorized for military applications. Silicon Labs products shall under no circumstances be used in weapons of mass destruction including (but not limited to) nuclear, biological or chemical weapons, or missiles capable of delivering such weapons. Silicon Labs disclaims all express and implied warranties and shall not be responsible or liable for any injuries or damages related to use of a Silicon Labs product in such unauthorized applications.

Trademark Information

Silicon Laboratories Inc.®, Silicon Laboratories®, Silicon Labs®, SiLabs® and the Silicon Labs logo®, Bluegiga®, Bluegiga Logo®, ClockBuilder®, CMEMS®, DSPLL®, EFM®, EFM32®, EFR®, Ember®, Energy Micro, Energy Micro logo and combinations thereof, "the world's most energy friendly microcontrollers", Ember®, EZLink®, EZRadio®, EZRadioPRO®, Gecko®, Gecko OS, Gecko OS Studio, ISOModem®, Precision32®, ProSLIC®, Simplicity Studio®, SiPHY®, Telegesis, the Telegesis Logo®, USBXpress®, Zentri, the Zentri logo and Zentri DMS, Z-Wave®, and others are trademarks or registered trademarks of Silicon Labs. ARM, CORTEX, Cortex-M3 and THUMB are trademarks or registered trademarks of ARM Holdings. Keil is a registered trademark of ARM Limited. Wi-Fi is a registered trademark of the Wi-Fi Alliance. All other products or brand names mentioned herein are trademarks of their respective holders.



Silicon Laboratories Inc.
400 West Cesar Chavez
Austin, TX 78701
USA

<http://www.silabs.com>