

Fiber Optic MT and MTP / MPO Cable Assemblies

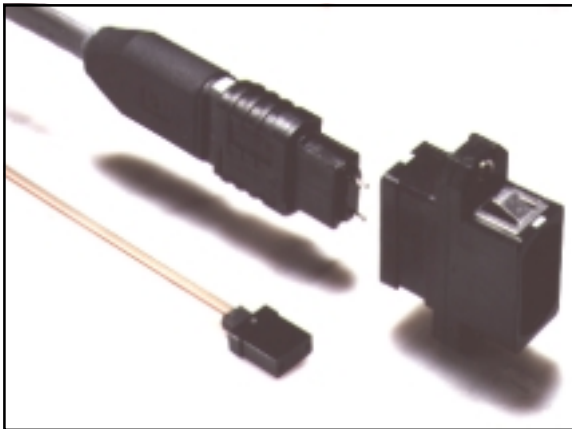

Features & Benefits

- Provides connectorized interface for ribbon or ribbonized fiber
- Connector alignment is made with precision alignment pins
- Fanouts to simplex fiber connectors available
- Low loss interconnect
- Push-pull mating of MTP* for quick connections
- NTT compatible
- Consistent and repeatable performance

Applications

- High density interconnects for:
 - Telephony central office and local loop
 - Data communications
- Provides interconnect for parallel optical transmitters and receivers

Molex MT and MTP connectorized ribbon fiber cable assemblies provide reliable high performance interconnects of up to 12 fibers in a minimum footprint. The MT connectors utilize the precision molded NTT compatible ferrule that connects 4 to 12 fibers using bare ribbon or ruggedized ribbon cable. Alignment between mating ferrules is accomplished using 2 precision guide pins that are pre-installed in a designated male connector. Two holes in the female connector locate the pins providing repeatable core to core alignment of the fibers. The MT ferrules are kept in the mated condition with the aid of a spring clip.

The MTP assemblies utilize the same MT ferrules and package them in a push-pull keyed connector housing for quick and easy connection using the MTP adapter. Guide pins in the male connector maintain alignment with holes in the female connector while the adapter retains the connectors in the mated position.

Back reflection for singlemode assemblies is controlled by using an 8 degree angle polishing process. Fanouts to single fiber leads connectorized with Molex industry standard SC, FC, and ST[†] connectors are available to interconnect with the current installed base of transmitters, receivers and patch panels.

An "enhanced" version of the multifiber connector has been developed to provide a quick and reliable connection for multiple optical fibers. The "enhanced" connector is a more precise NTT compatible ferrule, connecting the fibers using bare ribbon or ruggedized ribbon cable. The "enhanced" version will incorporate the same footprint and alignment as the standard MT/MTP.

This "enhanced" connector will solve customers needs for a high density solution with minimal insertion loss. The "enhanced" MTP housing is yellow and the MT ferrule is keyed with a yellow line.

*MTP is a registered trademark of US Conec Ltd.

†ST, STII are trademarks of Lucent Technologies

Performance and Specifications

Characteristics	Units	Min.	Avg.	Max.	Comments
Insertion Loss:					
9/125µm SM fiber	dB	-	.35	0.75	-
62.5/125µm MM fiber	dB	-	.3	0.75	-
Enhanced 9/125µm SM fiber	dB	-	.14	0.45	-
Return Loss:					
Singlemode	dB	-	-	< 60	Angle polish
Temperature Range	°C	-40	-	+80	40 cycles, 0.05 dB maximum change
Durability	dB	-	-	<0.2	1000 mate/unmate cycles

Fiber Optic MT and MTP* / MPO Cable Assemblies



Mechanical Dimensions

MT Connector

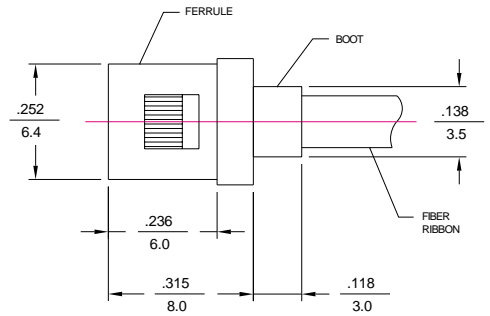
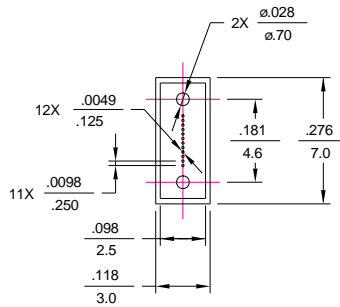
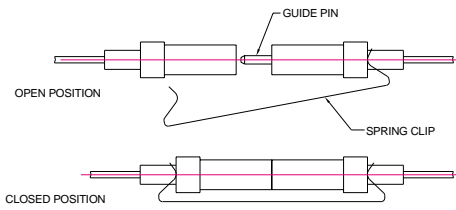

MTP Connector

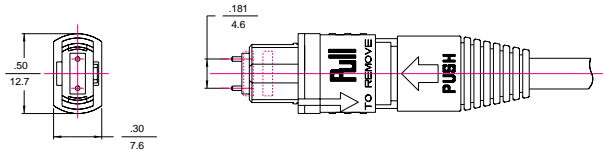
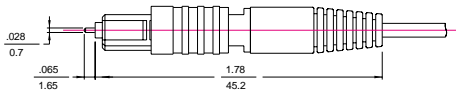

MTP Connector, 8 Degree

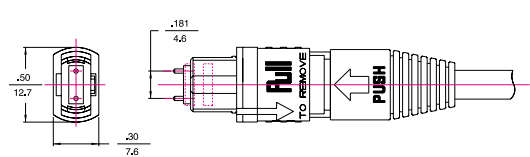
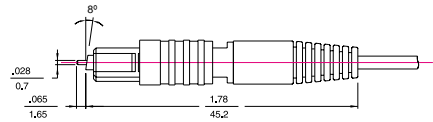

MTP Adapter

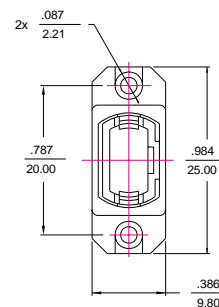
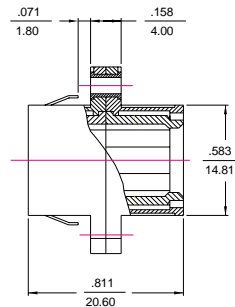
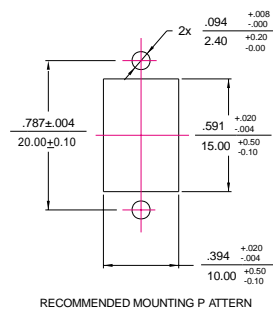

Fiber Optic MT and MTP* / MPO Cable Assemblies



Ordering Guide

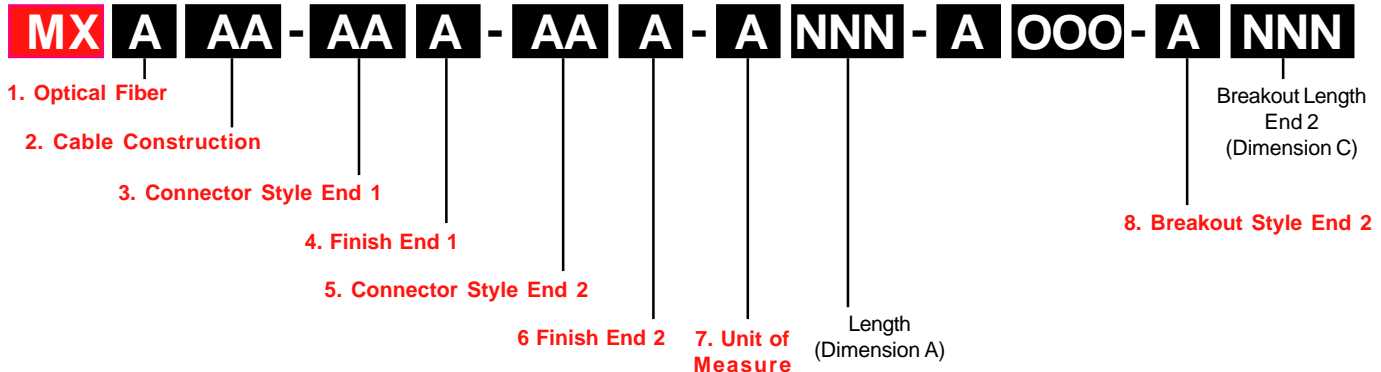

1. Optical Fiber

- A - Multimode, 50/125µm
- B - Multimode, 62.5/125µm
- D - Singlemode, 9/125µm

2. Cable Construction

- RA - Bare ribbon fiber, 4 fibers
- RB - Bare ribbon fiber, 8 fibers
- RC - Bare ribbon fiber, 10 fibers
- RD - Bare ribbon fiber, 12 fibers
- RE - Ribbon cable, OFNR, 4 fibers
- RF - Ribbon cable, OFNR, 8 fibers
- RG - Ribbon cable, OFNR, 10 fibers
- RH - Ribbon cable, OFNR, 12 fibers

3. Connector Style End 1

- MM - MT compatible, male
- MF - MT compatible, female
- PM - MTP/MPO compatible, male
- PF - MTP/MPO compatible, female

4. Finish End 1

- M - Flat
- P - Angle (singlemode)
- Q - "Enhanced" angle (singlemode)

5. Connector Style End 2

- AA - ST[†] compatible, polymer coupling nut
- AB - ST compatible, metal coupling nut
- AC - ST compatible, 90° boot, metal coupling nut
- BA - STII[†] compatible
- DA - FDDI, black housing
- DB - ESCON[‡] compatible
- EA - FC
- EB - FC/APC, standard key
- EC - FC/APC, tight fit key
- FA - SC, standard
- FB - SC, black housing, black boot
- FC - SC, red housing, red boot
- FD - SC, black housing, 90° black boot
- FE - SC, red housing, 90° red boot
- FF - SC/APC, green housing, green boot
- FG - SC Duplex
- GA - BSC
- GB - BSC/APC
- GC - BSCII
- GD - BSCII/APC
- HC - LC connector
- MM - MT compatible, male
- MF - MT compatible, female
- PH - BMTP pin holder, male
- PM - MTP/MPO compatible, male
- PF - MTP/MPO compatible, female
- ZZ - No connector (for End 2 only)

6. Finish End 2

- A - Multimode, ceramic ferrule, standard PC*
- B - Multimode, ceramic ferrule, enhanced PC
- C - Singlemode, RL > 45 dB, super PC
- D - Singlemode, RL > 55 dB, ultra PC
- E - Singlemode, RL > 70 dB, APC
- F - Multimode, stainless steel
- M - Flat
- P - Angle (SM)
- Q - "Enhanced" angle (SM)
- Z - No connector (for End 2 only)

7. Unit of Measure*

- *Numeric values must be consistent
- C - Centimeters
- F - Feet
- I - Inches
- M - Meters

Conversion Chart		
From	to	Multiply by
meter	inch	39.37
meter	foot	3.281
centimeter	inch	.394
meter	centimeter	100

8. Breakout Style End 2

- A - No breakout
- R - Ribbon to 900µm

[†]ST and STII are registered trademarks of Lucent Technologies

[‡]ESCON is a registered trademark of International Business Machines Corporation

Example 1

Customer desires a 62.5/125µm 12 fiber ribbon cable type OFNR jumper terminated with a male MTP connector and 12 SC connectors. The overall length is 20 meters with a break out length of 0.5 meters using 900µm jacketed fanout.

Ordering Format:

MXBRH-PMM-FAB-M020-A000-R0.5

Example 2

Customer desires a 62.5/125µm 8 fiber bare ribbon jumper terminated with a male MT and a female MT connector. The length is 3 feet.

Ordering Format:

MXBRB-MMM-MFM-F003-A000-A000

Fiber Optic MT and MTP* / MPO Cable Assemblies



Assembly Construction & Breakout Detail

MT to MT

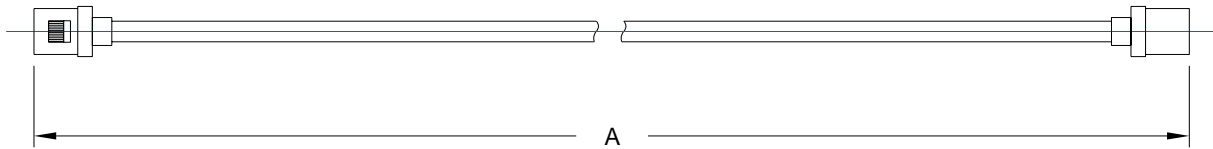

MT to Simplex Fanout

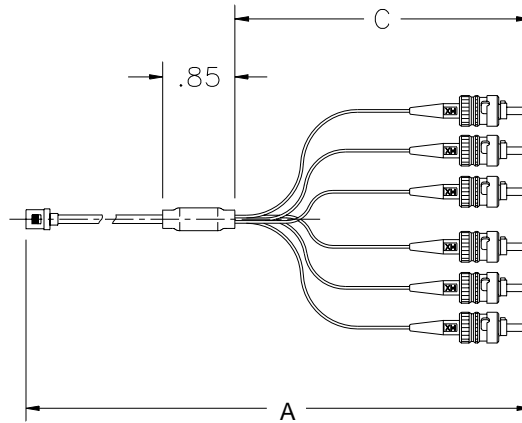

MTP to MTP

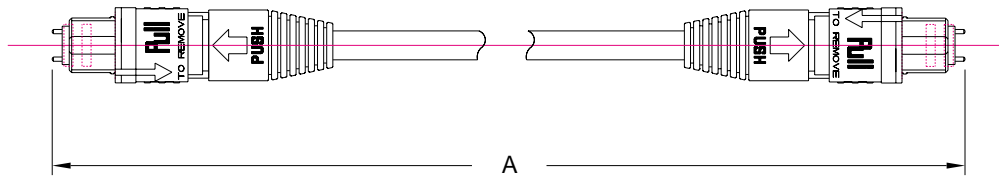

MTP to Simplex Fanout

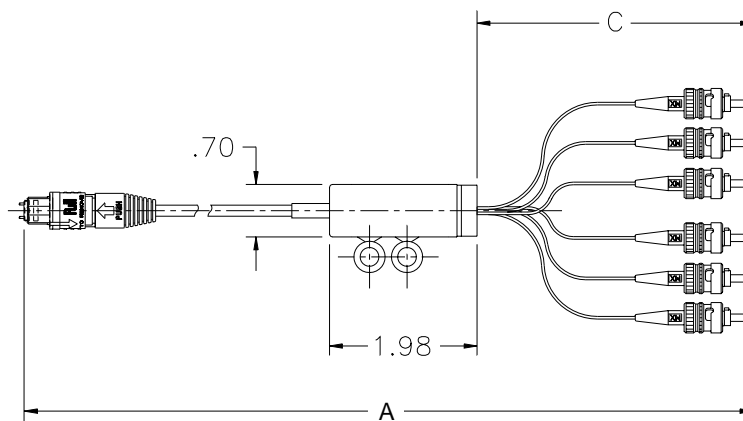

Standard Part Numbers

Order Number	Description
86181-0000	MTP adapter
86180-3001	MT spring clip (8 fibers or less)
86180-3201	MT spring clip (greater than 8 fibers)
86780-0010	MT spring fastener tool