

SHORTER BEHIND PANEL DEPTH



The HTWM offers the same performance as the standard HTW Proportional Thumbwheel but with a much shorter behind panel depth, ideal for use in grip, armrest and panel applications. Available with eight output options, the HTWM offers a spring-return-to-center, single axis thumbwheel actuator that provides linear change in voltage output in either direction from center. Options include increasing or decreasing voltage output from the center position to the full travel position, and single or dual (redundant) outputs per axis. The HTWM offers snap-in style mounting and a three million cycle rotational life. The HTWM electronics are sealed to IP68S and have excellent EMI/RFI immunity.

Features:

- Shorter behind panel depth: 0.96" max.
- 8 output options
- Spring-return-to-center single axis actuator
- Rocker switch style mounting
- 3 million cycle rotational life
- Electronics sealed to IP68S
- Excellent EMI/RFI immunity
- RoHS/WEEE/Reach compliant

Standard Characteristics/Ratings:

MECHANICAL:

Mechanical Life: 3,000,000 full forward to full back

Max Allowable Radial Load: 30.0 lbs.

ELECTRICAL RATINGS: Rated at Vcc = 5V @ 25°C Load = 1mA (4.7KΩ)

Electrical	Units	Min	Typ	Max
Supply Voltage	VDC	4.5	5	5.5
Output Voltage Tolerance at Center @ 5V Vcc	VDC	-0.25	N/A	+0.25
Output Voltage Tolerance at Full Travel @ 5V Vcc	VDC	-0.25	N/A	+0.25
Supply Current Per Sensor	mA	N/A	N/A	10

ELECTRONICS:

Seal Integrity: Electronics IP68S

ENVIRONMENTAL:

Operating Temp Range: -40°C to +85°C

Humidity: 96% RH, 70°C, 96 hours

Vibration: Per MIL-810F minimum integrity

Sand/Dust: Per SAE J1455

EMI: Withstand per MIL-STD-461D/SAE J1113-22

RFI: Withstand 100V/M 14Hz to 1GHz

MATERIALS:

Button: Thermoplastic

Bezel: Thermoplastic

Wires: 18 AWG

MINI PROPORTIONAL OUTPUT THUMBWHEEL

SHORTER BEHIND PANEL DEPTH

HTWM PART NUMBER CODE

HTWM	-	X	X	X	X	X	X	X
Travel								
1. +/- 40°								
Output 1*								
A. 2.5 +/- 2.0VDC								
B. 2.5 +/- 2.0VDC								
C. 2.5 +/- 2.0VDC								
D. 2.5 +/- 1.5VDC								
E. 2.5 +/- 1.5VDC								
F. 2.5 +/- 1.5VDC								
G. 1.0 - 4.0VDC								
H. 0.5 - 4.5VDC								
Output 2**								
NONE								
2.5 +/- 2.0VDC								
2.5 +/- 2.0VDC								
NONE								
2.5 +/- 1.5VDC								
2.5 +/- 1.5VDC								
1.0 - 4.0VDC								
0.5 - 4.5VDC								
Operating Force								
1. 5.0 oz.								
Button Style								
1. Knurled Wheel								
2. Paddle Wheel								
Termination								
A. 18 AWG Wires, 18.3" Long, Stripped Ends								
B. 0.025" SQ. Pins								
Bezel Color								
1. Red								
2. Black								
3. Orange								
4. Yellow								
5. Green								
6. Blue								
7. Violet								
8. Gray								
9. White								
Button Color								
1. Red								
2. Black								
3. Orange								
4. Yellow								
5. Green								
6. Blue								
7. Violet								
8. Gray								
9. White								

* Outputs are from the center position to the full travel position in each direction. Options A-F provide increasing voltage in Direction 1 and decreasing voltage in Direction 2 from a single output. Options G and H provide increasing voltages in both directions from two separate outputs.

** Options B and E provide redundant output 2 which duplicates output 1. Options C and F provide redundant output 2 which is inverse of output 1.

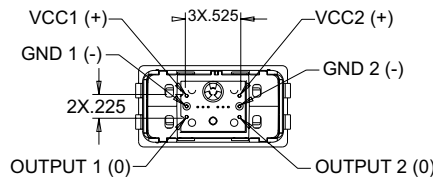
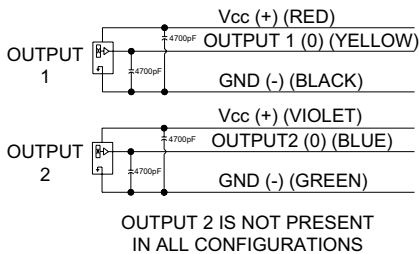
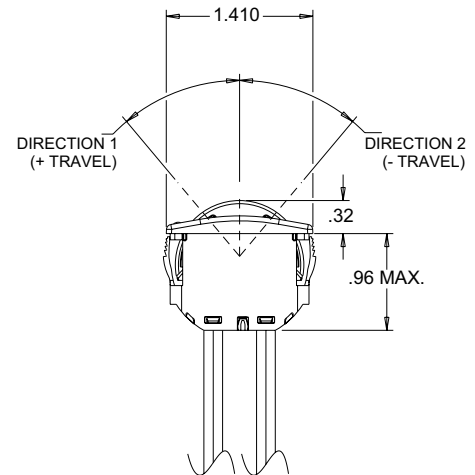
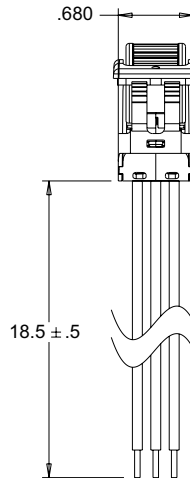
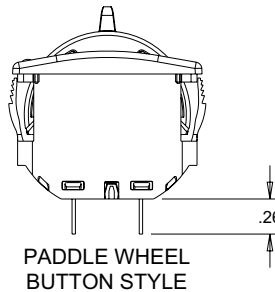
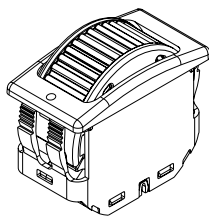

**PINNED
TERMINATION**
NOT ALL PINS ARE PRESENT
IN ALL OUTPUT CONFIGURATIONS

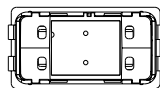

NOT ALL WIRES ARE PRESENT
IN ALL OUTPUT CONFIGURATIONS

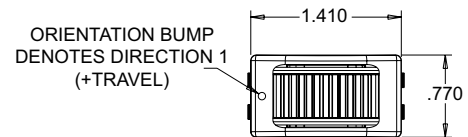

MOUNTING:

RECOMMENDED PANEL THICKNESS: 0.150 OPTIMUM THICKNESS
(0.040 MIN. - 0.200 MAX.)

RECOMMENDED PANEL OPENING: 0.700 X 1.340 OPTIMUM
(0.695/0.705 X 1.335/1.345)

RECOMMENDED PANEL RADI: 0.100 OPTIMUM
(0.090 - 0.110 MAX.)

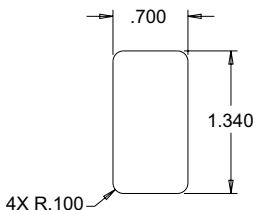

SHORTER BEHIND PANEL DEPTH

OPTION A

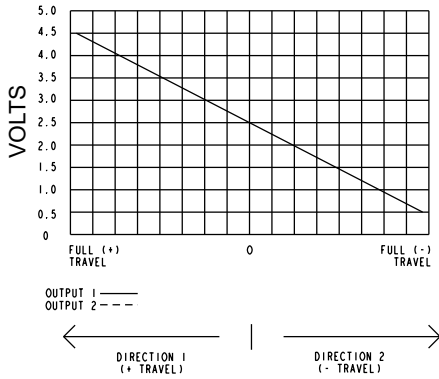

OPTION B

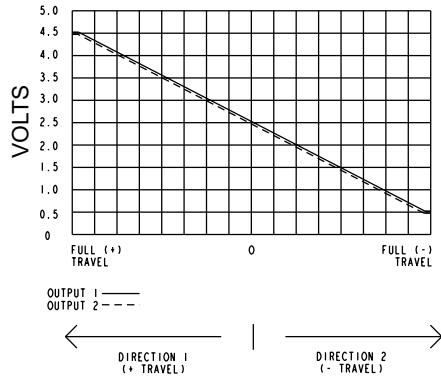

OPTION C

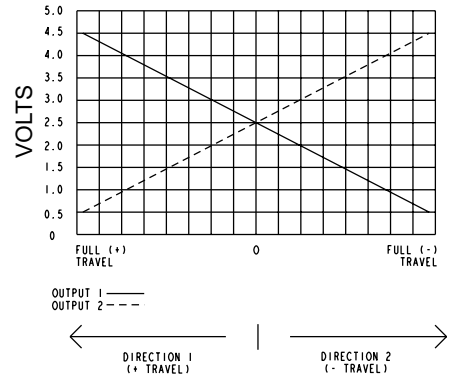

OPTION D

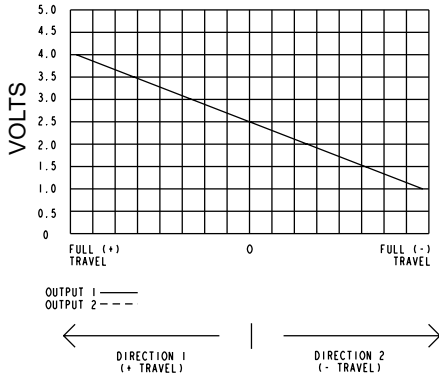

OPTION E

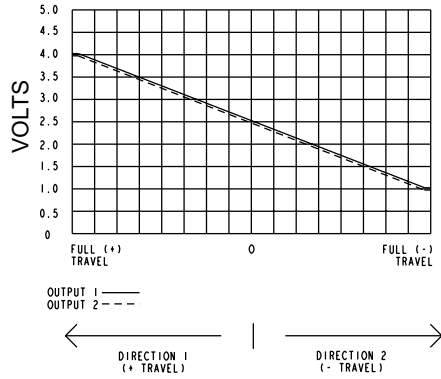

OPTION F

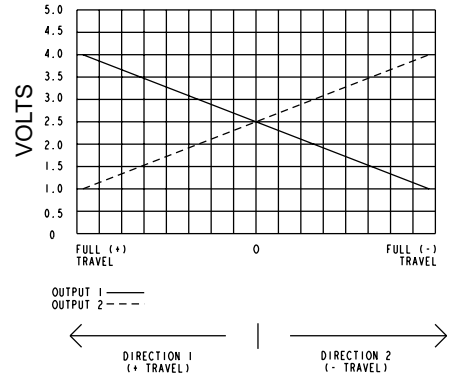

OPTION G

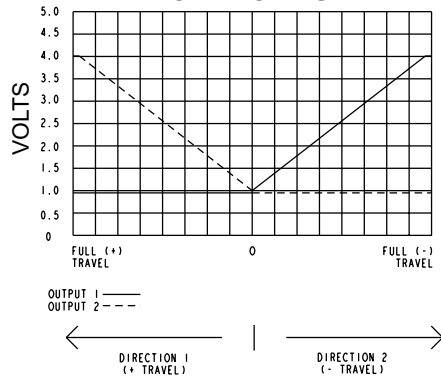

OPTION H

