

A Unit of Teledyne Electronics and Communications

MAGNETIC-LATCHING, BROADBAND RF RELAYS DPDT

SERIES RF180

DESCRIPTION

The Series RF180 relay is an ultraminiature, hermetically sealed, magnetic-latching relay featuring extremely low intercontact capacitance for exceptional RF performance over the full UHF spectrum. Its low profile height and .100" grid spaced terminals make it ideal for applications where extreme packaging density and/or close PC board spacing are required.

The RF180 design has been optimized for use in RF attenuators, RF switch matrices, and other applications requiring magnetic latching, high isolation, low insertion loss and low VSWR.

Unique construction features and manufacturing techniques provide high reliability and excellent robustness to environmental extremes.

- All welded construction.
- Unique uniframe design provides high magnetic efficiency and mechanical rigidity.
- High force/mass ratios for resistance to shock and vibration.
- Advanced cleaning techniques provide maximum assurance of internal cleanliness.
- Gold-plated precious metal alloy contacts ensure reliable d.c. switching from dry-circuit to 1/4 amp, as well as low and stable insertion loss in RF applications.

The RF180 relay is ideally suited for applications where power dissipation must be minimized. The relays can be operated with a short-duration coil voltage pulse. After the contacts have transferred, no coil power is required.

The magnetic-latching feature of the RF180 provides a nonvolatile memory capability, since the relays will not reset upon removal of coil power.

PRINCIPLE OF OPERATION

Energizing Coil A produces a magnetic field opposing the magnetic field of the permanent magnet in Circuit A. As the net holding force decreases, the attractive force in the air gap of Circuit B, which also results from the magnetic field of the permanent magnet, becomes great enough to break the armature free of Core A, and snap it into a closed position against Core B. The armature remains in this position upon removal of power from Coil A, but will snap back into position A upon energizing Coil B. Since operation depends upon cancellation of a magnetic field, it is necessary to apply the correct polarity to the relay coils as indicated on the relay schematic.

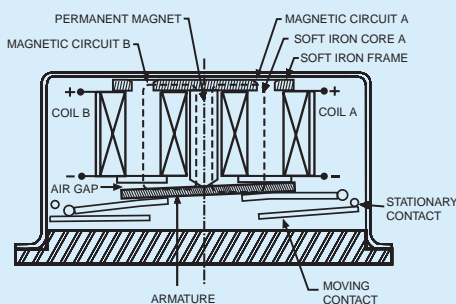

When latching relays are installed in equipment, the latch and reset coils should not be pulsed simultaneously. Coils should not be pulsed with less than rated coil voltage and the pulse width should be a minimum of three times the specified operate time of the relay. If these conditions are not followed, it is possible for the relay to be in the magnetic neutral position.

ENVIRONMENTAL AND PHYSICAL SPECIFICATIONS

Temperature (Ambient)	Storage	-65°C to +125°C
	Operating	-55°C to +85°C
Vibration (General Note 1)		30 g's to 3000 Hz
Shock (General Note 1)		100 g's, 6 msec, half-sine
Enclosure		Hermetically sealed
Weight		0.10 oz. (2.9g) max.

SERIES RF180

TYPICAL RF CHARACTERISTICS CURVES (SEE RF NOTES)

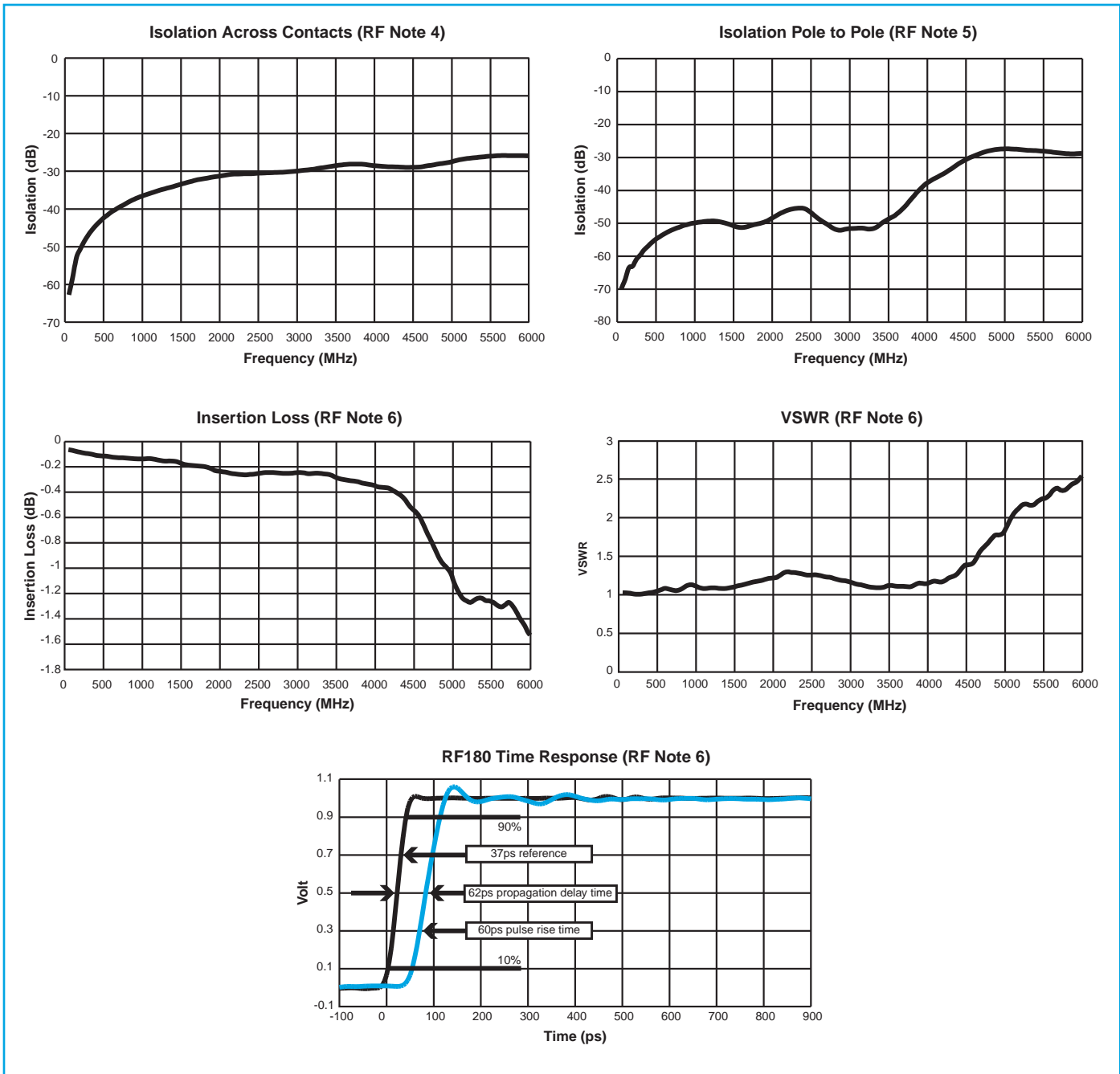

RF NOTES

- Test conditions:
 - Fixture: .031" copper clad, reinforced PTFE, RT/duroid® 6002 with SMA connectors. (RT/duroid® is a registered trademark of Rogers Corporation.)
 - Relay header is in contact with, but not soldered to, ground plane or connected to ground via ground pin.
 - Test performed at room ambient temperature.
 - Terminals not tested were terminated with 50-ohm load.
 - Contact signal level: -10 dBm.
- Data presented herein represents typical characteristics and is not intended for use as specification limits.
- Data is per pole, except for pole-to-pole data.
- Data is the average from readings taken on all open contacts.
- Data is the average from readings taken on poles after Coil A is energized then Coil B is energized.
- Data is the average from readings taken on all closed contacts.
- Test fixture effect de-embedded from frequency and time response data.

SERIES RF180

GENERAL ELECTRICAL SPECIFICATIONS (@ 25°C) (General Note 2)

Contact Arrangement	2 Form C (DPDT)
Rated Duty	Continuous
Contact Resistance	0.15Ω maximum before life; 0.25Ω maximum after life at 0.25A/28Vdc (measured 1/8" from header)
Contact Load Rating (DC)	Resistive: 0.25A/28Vdc Low Level: 10 to 50 μA/10 to 50 mV
Characteristic Contact Life Ratings (General Note 3)	10,000,000 cycles (typical) at low level (General Note 3) 100,000 cycles minimum at all other loads specified above
Contact Overload Rating	0.5A/28Vdc Resistive (100 cycles minimum)
Contact Carry Rating	Contact factory
Coil Operating Power	290 milliwatts typical at nominal rated voltage @25°C
Operate Time	2.0 msec. maximum at nominal rated coil voltage
Minimum Operate Pulse	6.0 msec. width at rated voltage
Interconnect Capacitance	0.02 pf typical
Insulation Resistance	1,000 MΩ minimum between mutually isolated terminals
Dielectric Strength	Atmospheric pressure: 350 Vrms (60 Hz)

DETAILED ELECTRICAL SPECIFICATIONS (@ 25°C) (General Note 2)

BASE PART NUMBERS		RF180-5	RF180-12	RF180-26
Coil Voltage (Vdc)	Nom.	5.0	12.0	26.5
	Max.	6.0	16.0	32.0
Coil Resistance (Ohms ±20%)		61	500	2000
Set & Reset Voltage (Vdc max.)		3.5	9.0	18.0

GENERAL NOTES

1. Relays will exhibit no contact chatter in excess of 10 μsec or transfer in excess of 1 μsec.
2. Unless otherwise specified, parameters are initial values.
3. For extended contact life ratings, contact factory.
4. Contacts shown in position resulting when Coil B last energized.

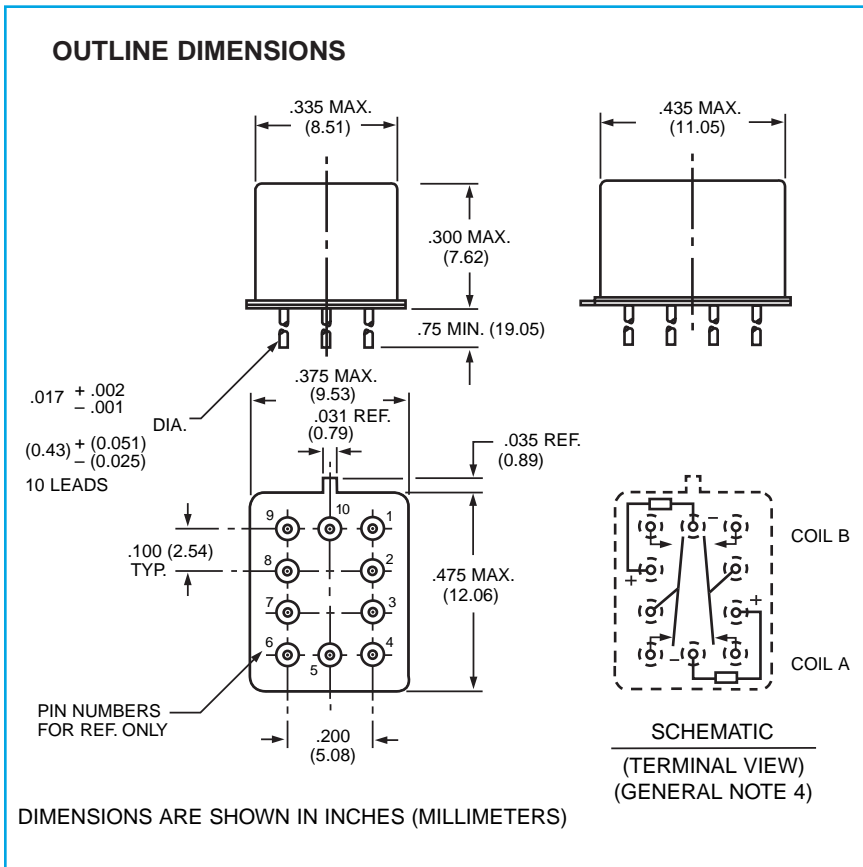

Appendix A: Spacer Pads

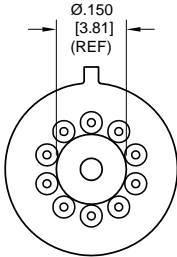
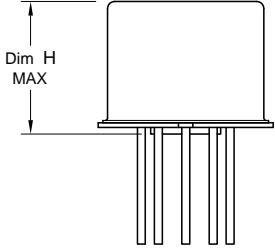
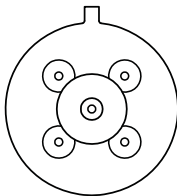
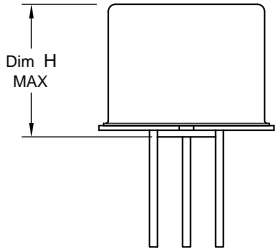
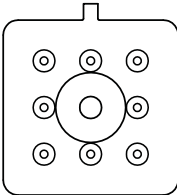
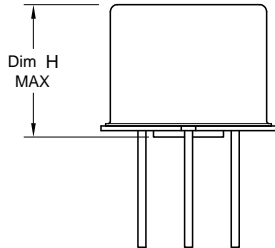
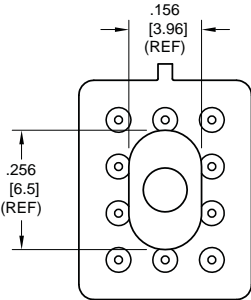
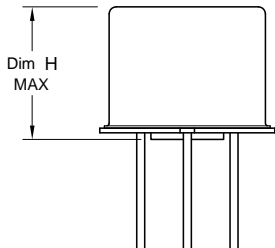
Pad designation and bottom view dimensions	Height	For use with the following:	Dim. H Max.
 <p style="text-align: center;">“M4” Pad for TO-5</p>		ER411T ER412, ER412D, ER412DD	.295 (7.49)
		712, 712D, 712TN, RF300, RF310, RF320	.300 (7.62)
		ER420, ER422D, ER420DD, 421, ER421D, ER421DD, ER422, ER422D, ER422DD, 722, 722D, RF341	.305 (7.75)
		ER431T, ER432T, ER432, ER432D, ER432DD	.400 (10.16)
		732, 732D, 732TN, RF303, RF313, RF323	.410 (10.41)
		RF312	.350 (8.89)
 <p style="text-align: center;">“M4” Pad for TO-5</p>		ER411, ER411D, ER411DD	.295 (7.49)
		ER431, ER431D, ER431DD	.400 (10.16)
		RF311	.300 (7.62)
		RF331	.410 (10.41)
 <p style="text-align: center;">“M4” Pad for Centigrid®</p>		172, 172D	.305 (7.75)
		ER114, ER114D, ER114DD, J114, J114D, J114DD	.300 (7.62)
		ER134, ER134D, ER134DD, J134, J134D, J134DD	.400 (10.16)
		RF100	.315 (8.00)
		RF103	.420 (10.67)
 <p style="text-align: center;">“M9” Pad for Centigrid®</p>		122C, A152	.320 (8.13)
		ER116C, J116C	.300 (7.62)
		ER136C, J136C	.400 (10.16)
		RF180	.325 (8.25)
		A150	.305 (7.75)

Notes:

1. Spacer pad material: Polyester film.
2. To specify an “M4” or “M9” spacer pad, refer to the mounting variants portion of the part numbering example in the applicable datasheet.
3. Dimensions are in inches (mm).
4. Unless otherwise specified, tolerance is $\pm .010$ (.25).
5. Add 10 m Ω to the contact resistance show in the datasheet.
6. Add 0.01 oz. (0.25 g) to the weight of the relay assembly shown in the datasheet.

Appendix A: Spreader Pads

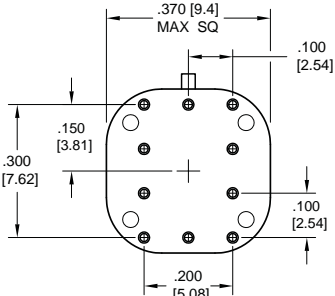
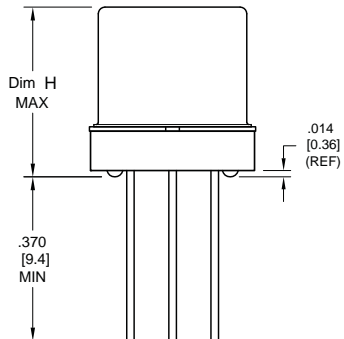
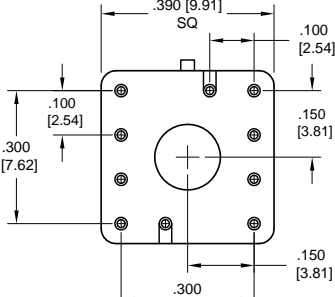
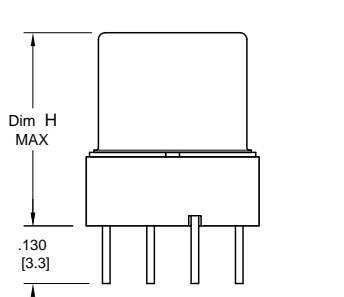
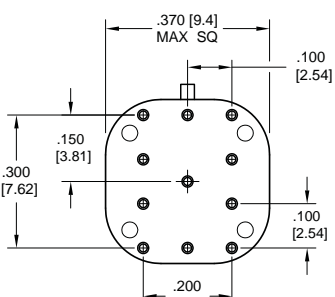
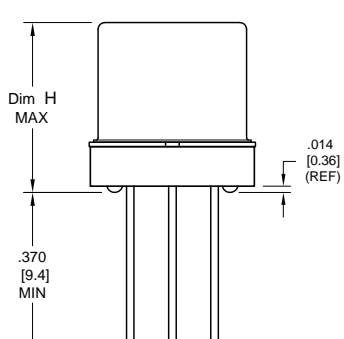
Pad designation and bottom view dimensions	Height	For use with the following:	Dim. H Max.
 <p>"M" Pad <u>5/</u> <u>6/</u> <u>9/</u></p>		ER411T, J411T, ER412, ER412D ER412DD, J412, J412D, J412DD ER412T, J412T	.388 (9.86)
		712, 712D, 712TN	.393 (9.99)
		ER431T, J431T, ER432, ER432D ER432DD, J432, J432D, J432DD ER432T, J432T	.493 (12.52)
		732, 732D, 732TN	.503 (12.78)
		ER420, J420, ER420D, J420D ER420DD, J420DD, ER421, J421 ER421D, J421D, ER421DD J422D, ER422DD, J422DD, 722	.398 (10.11)
 <p>"M4" Pad <u>7/</u> <u>8/</u></p>		ER411T ER412, ER412D, ER412DD J412, J412D, J412DD	.441 (11.20)
		712, 712D	.451 (11.46)
		ER421, ER421D, ER421DD 722, 732D	.451 (11.46)
		ER431T ER432, ER432D, ER432DD	.546 (13.87)
		732, 732D	.556 (14.12)
 <p>"M5" Pad <u>5/</u> <u>6/</u> <u>9/</u></p>		ER411, ER411D, ER411DD ER411TX ER412X, ER412DX, ER412DDX ER412TX	.388 (9.86)
		712X, 712DX, 712TNX	.393 (9.99)
		ER420X, ER420DX, ER420DDX ER421X, ER421DX, ER421DDX ER422X, ER422DX ER422DDX, 722X, 722DDX	.398 (10.11)
		ER431, ER431D, ER431DD ER431TX ER432X, ER432DX, ER432DDX ER432TX	.493 (12.52)
		732X, 732DX, 732TNX	.503 (12.78)

Notes:

1. Spreader pad material: Diallyl Phthalate.
2. To specify an "M", "M2" or "M3" spreader pad, refer to the mounting variants portion of the part number example in the applicable datasheet.
3. Dimensions are in inches (mm).
4. Unless otherwise specified, tolerance is $\pm .010$ " (0.25).
- 5/. Add 25 m Ω to the contact resistance shown in the datasheet.
- 6/. Add .01 oz. (0.25 g) to the weight of the relay assembly shown in the datasheet.
- 7/. Add 50 m Ω to the contact resistance shown in the datasheet.
- 8/. Add 0.025 oz (0.71 g) to the weight of the relay assembly shown in the datasheet.
- 9/. M3 pad to be used only when the relay has a center pin (e.g. ER411M3-12A, 722XM3-26.)

Appendix A: Ground Pin Positions

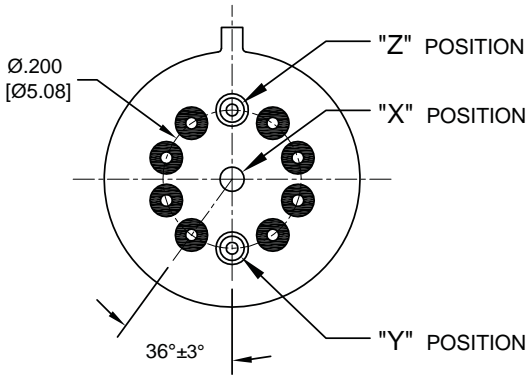

TO-5 Relays:

ER411T, ER412, ER412T, ER420, ER421, ER422,
ER431T, ER432, ER432T, 712, 712TN, 400H, 400K,
400V, RF300, RF303, RF341, RF312, RF310, RF313,
RF320, RF323

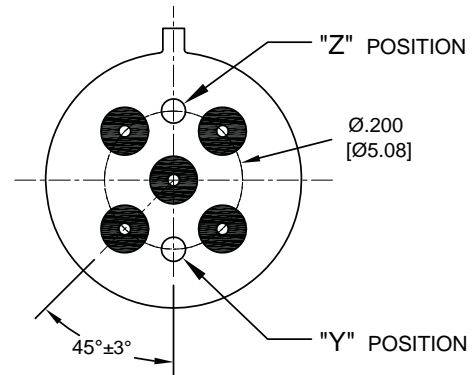

TO-5 Relays:

ER411, ER431, RF311, RF331

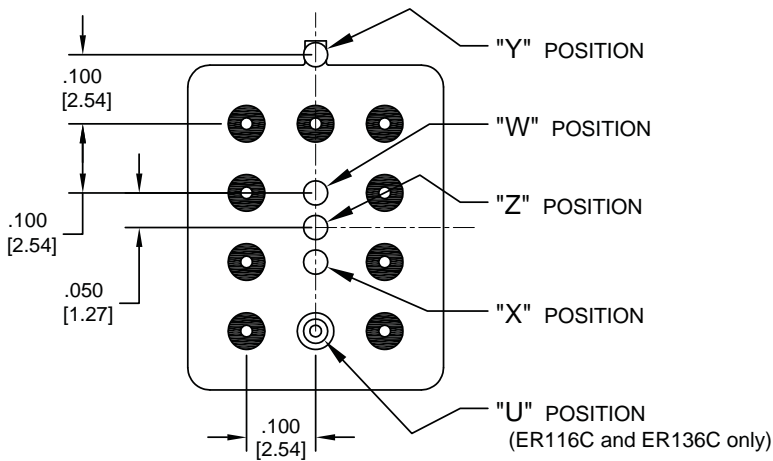

Centigrid® Relays:

RF180, ER116C, 122C, ER136C

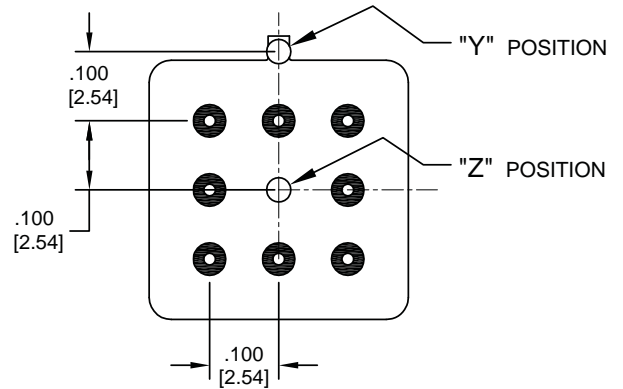

Centigrid® Relays:

RF100, RF103, ER114, ER134, 172

- Indicates ground pin position
- Indicates glass insulated lead position
- ◎ Indicates ground pin or lead position depending on relay type

NOTES

1. Terminal views shown
2. Dimensions are in inches (mm)
3. Tolerances: $\pm .010$ ($\pm .25$) unless otherwise specified
4. Ground pin positions are within $.015$ (0.38) dia. of true position
5. Ground pin head dia., 0.035 (0.89) ref: height 0.010 (0.25) ref.
6. Lead dia. 0.017 (0.43) nom.