



NUMBER <b>GS-12-651</b>	TYPE <b>PRODUCT SPECIFICATION</b>		
TITLE <b>MINI-SAS HD External Cable to Board Connector System</b>		PAGE 1 of 14	REVISION F
		AUTHORIZED BY Roger Cheng	DATE 2013-12-19
CLASSIFICATION <b>UNRESTRICTED</b>			

## TABLE OF CONTENTS

<b>1.0</b>	<b>OBJECTIVE .....</b>	<b>3</b>
<b>2.0</b>	<b>SCOPE .....</b>	<b>3</b>
<b>3.0</b>	<b>APPLICABLE DOCUMENTS.....</b>	<b>3</b>
<b>3.1</b>	<b>FCI SPECIFICATIONS.....</b>	<b>3</b>
<b>3.2</b>	<b>OTHER STANDARDS AND SPECIFICATIONS.....</b>	<b>3</b>
<b>3.3</b>	<b>FCI PRODUCT QUALIFICATION TEST REPORTS.....</b>	<b>3</b>
<b>3.4</b>	<b>SAFETY AGENCY APPROVALS.....</b>	<b>3</b>
<b>4.0</b>	<b>RATINGS .....</b>	<b>3</b>
<b>4.1</b>	<b>VOLTAGE .....</b>	<b>3</b>
<b>4.2</b>	<b>CURRENT .....</b>	<b>3</b>
<b>4.3</b>	<b>TEMPERATURE .....</b>	<b>3</b>
<b>5.0</b>	<b>GENERAL REQUIREMENTS .....</b>	<b>4</b>
<b>5.1</b>	<b>MATERIALS, PLATING, AND PRODUCT MARKINGS .....</b>	<b>4</b>
<b>5.2</b>	<b>VISUAL EXAMINATION OF PRODUCT.....</b>	<b>4</b>
<b>6.0</b>	<b>2 WIRE INTERFACE EEPROM .....</b>	<b>4</b>
<b>7.0</b>	<b>ELECTRICAL REQUIREMENTS .....</b>	<b>4</b>
<b>7.1</b>	<b>LOW LEVEL CONTACT RESISTANCE (LLCR) .....</b>	<b>4</b>
<b>7.2</b>	<b>DIELECTRIC WITHSTANDING VOLTAGE (DWV) .....</b>	<b>4</b>
<b>7.3</b>	<b>CURRENT RATING (VIA CURRENT CYCLING) .....</b>	<b>4</b>
<b>7.4</b>	<b>DIFFERENTIAL IMPEDANCE .....</b>	<b>4</b>
<b>8.0</b>	<b>MECHANICAL REQUIREMENTS.....</b>	<b>5</b>
<b>8.1</b>	<b>MATING / UN-MATING FORCES .....</b>	<b>5</b>
<b>8.2</b>	<b>LATCH MATING FORCE.....</b>	<b>5</b>
<b>8.3</b>	<b>DE-LATCHING FORCE .....</b>	<b>5</b>
<b>8.4</b>	<b>LATCH TAB PULL STRENGTH.....</b>	<b>5</b>
<b>8.5</b>	<b>LATCHED RETENTION (CABLE CONNECTOR RETENTION IN CAGE).....</b>	<b>5</b>
<b>8.6</b>	<b>CABLE JACKET RETENTION .....</b>	<b>5</b>
<b>8.7</b>	<b>WIRE FLEX.....</b>	<b>5</b>
<b>8.8</b>	<b>PRESS-FIT INSERTION FORCES .....</b>	<b>6</b>
<b>8.9</b>	<b>PRESS-FIT WITHDRAWAL FORCES .....</b>	<b>6</b>
<b>8.10</b>	<b>CONNECTOR LONGITUDINAL LOADING .....</b>	<b>6</b>
<b>8.11</b>	<b>CONNECTOR LATITUDINAL LOADING .....</b>	<b>7</b>
<b>8.12</b>	<b>RIGHT ANGLE PULL OUT .....</b>	<b>7</b>
<b>8.13</b>	<b>DURABILITY .....</b>	<b>7</b>
<b>8.14</b>	<b>DURABILITY PRE-CONDITIONING .....</b>	<b>8</b>
<b>8.15</b>	<b>SCREW TORQUE.....</b>	<b>8</b>
<b>8.16</b>	<b>PCB PTH DEGRADATION .....</b>	<b>8</b>
<b>8.16.1</b>	<b>PTH RADIAL DEFORMATION .....</b>	<b>8</b>
<b>8.16.2</b>	<b>PTH REMAINING COPPER THICKNESS .....</b>	<b>8</b>
<b>8.16.3</b>	<b>PTH WALL DAMAGE .....</b>	<b>8</b>
<b>9.0</b>	<b>ENVIRONMENTAL REQUIREMENTS.....</b>	<b>8</b>

NUMBER <b>GS-12-651</b>	TYPE <b>PRODUCT SPECIFICATION</b>		
TITLE <b>MINI-SAS HD External Cable to Board Connector System</b>		PAGE <b>2 of 14</b>	REVISION <b>F</b>
		AUTHORIZED BY <b>Roger Cheng</b>	DATE <b>2013-12-19</b>
		CLASSIFICATION <b>UNRESTRICTED</b>	

<b>9.1</b>	<b>TEMPERATURE LIFE.....</b>	<b>8</b>
<b>9.2</b>	<b>TEMPERATURE LIFE PRECONDITIONING.....</b>	<b>8</b>
<b>9.3</b>	<b>THERMAL SHOCK.....</b>	<b>9</b>
<b>9.4</b>	<b>CYCLICAL HUMIDITY AND TEMPERATURE.....</b>	<b>9</b>
<b>9.5</b>	<b>MECHANICAL VIBRATION.....</b>	<b>9</b>
<b>9.6</b>	<b>MIXED FLOWING GAS (MFG).....</b>	<b>9</b>
<b>9.7</b>	<b>THERMAL DISTURBANCE.....</b>	<b>9</b>
<b>9.8</b>	<b>RESEAT.....</b>	<b>9</b>
<b>9.9</b>	<b>CONNECTOR REPAIR.....</b>	<b>9</b>
<b>10.0</b>	<b>QUALITY ASSURANCE PROVISIONS.....</b>	<b>10</b>
<b>10.1</b>	<b>EQUIPMENT CALIBRATION.....</b>	<b>10</b>
<b>10.2</b>	<b>INSPECTION CONDITIONS.....</b>	<b>10</b>
<b>10.3</b>	<b>SAMPLE QUANTITY AND DESCRIPTION.....</b>	<b>10</b>
<b>10.4</b>	<b>ACCEPTANCE.....</b>	<b>10</b>
<b>10.5</b>	<b>QUALIFICATION TESTING.....</b>	<b>10</b>
<b>10.6</b>	<b>RE-QUALIFICATION TESTING.....</b>	<b>10</b>
<b>11.0</b>	<b>SUPPORTING INFORMATION.....</b>	<b>13</b>
<b>12.0</b>	<b>EEPROM INFORMATION FOR MSHD CABLE ASS'Y.....</b>	<b>14</b>
<b>13.0</b>	<b>REVISION RECORD.....</b>	<b>14</b>

NUMBER <b>GS-12-651</b>	TYPE <b>PRODUCT SPECIFICATION</b>		
TITLE <b>MINI-SAS HD External Cable to Board Connector System</b>		PAGE <b>3 of 14</b>	REVISION <b>F</b>
		AUTHORIZED BY <b>Roger Cheng</b>	DATE <b>2013-12-19</b>
		CLASSIFICATION <b>UNRESTRICTED</b>	

## 1.0 OBJECTIVE

This specification defines the quality and reliability, performance, and test requirements of the MINI-SAS HD external connector system. This specification applies to the 1X1, 1x2, and 1X4 size configurations.

## 2.0 SCOPE

This specification is applicable to the MINI-SAS HD external connector system which provides a high speed cable to board interconnect.

## 3.0 APPLICABLE DOCUMENTS

### 3.1 FCI Specifications

- Applicable FCI product customer drawings
- GS-20-0327: FCI Application Specification, MINI-SAS HD external connector system
- GS-14-1490 FCI Packaging Specification, MINI-SAS HD external connector system

### 3.2 Other Standards and Specifications

- UL94V-0: Test for Flammability of Plastic Materials in Devices and Appliances
- EIA 364: Electrical Connector/Socket Test Procedures Including Environmental Classifications
- SFF 8644: Mini Multilane Shielded Integrated HD Connector
- SFF 8636: Common Management Interface
- SFF 8417: Multi Conductor Cable Flex Cycle Test Procedure
- GR-1217-CORE:Telcordia Specification “ Generic Requirements for Separable Electrical Connectors”

### 3.3 FCI Product Qualification Test reports

- GS-29-0163: MINI-SAS HD External Cable to Board Connector System
- EL-2012-10-027-FR-GES-001: External 14G MINI-SAS HD Cable Assembly Cable Flex Testing

### 3.4 Safety Agency Approvals

- UL File Number: E66906

## 4.0 RATINGS

### 4.1 Voltage

- 30 Volts AC (RMS) / DC Maximum

### 4.2 Current

- 0.5 Amps Maximum

### 4.3 Temperature

- Operating: -40°C to +80°C
- Non-operating: -55°C to +80°C

NUMBER <b>GS-12-651</b>	TYPE <b>PRODUCT SPECIFICATION</b>		
TITLE <b>MINI-SAS HD External Cable to Board Connector System</b>		PAGE <b>4 of 14</b>	REVISION <b>F</b>
		AUTHORIZED BY <b>Roger Cheng</b>	DATE <b>2013-12-19</b>
		CLASSIFICATION <b>UNRESTRICTED</b>	

## 5.0 GENERAL REQUIREMENTS

### 5.1 **Materials, Plating, and Product Markings**

Refer to the appropriate customer drawing for the materials, plating, and product markings.

### 5.2 **Visual Examination of Product**

Visual examinations shall be performed using 10X magnification. Parts should be free from blistering, cracks, etc.

## 6.0 2 WIRE INTERFACE EEPROM

The MINI SAS HD serial ID provides access to sophisticated identification information that describes the Transceiver's capabilities, standard interfaces, manufacturer, and other information. The EEPROM on the MINI SAS HD External cable assembly is designed for 255 addresses. The information for addresses will be programmed in accordance with SFF8636 and/or customer own specification.

## 7.0 ELECTRICAL REQUIREMENTS

### 7.1 **Low Level Contact Resistance (LLCR)**

Measurements shall be performed per EIA 364-23. The maximum change in low level contact resistance, from the initial measurement, shall be less than 10 milliohms. The following details apply:

- Test Voltage: 20 mV maximum
- Test Current: 100 mA maximum

### 7.2 **Dielectric Withstanding Voltage (DWV)**

There shall be no evidence of arc-over, insulation breakdown, or excessive current leakage (> 5 mA) when mated connectors are tested in accordance with EIA 364-20, method B, condition 1. The following details shall apply:

- Test Voltage: 300 VDC
- Test Duration: 60 seconds
- Points of Measurement: Between signal contact pairs.
- Number of readings: 30 minimum

### 7.3 **Current Rating (Via Current Cycling)**

The temperature rise above ambient shall not exceed 30 degrees C when all contacts are powered at their maximum rating of a 0.5 A (per section 4.2). Test shall be performed in still air with an ambient temperature of 25°C. Connector's shall be cycled in one hour durations, 96 times, with the power being on for 45 minutes, followed by the power being turned off for 15 minutes. Temperature shall be measured after the 96<sup>th</sup> cycle.

### 7.4 **Differential Impedance**

The impedance of a mated cable to a corresponding board connector shall be  $100 \pm 10$  ohms when tested with a rise time of 70ps (20% - 80%).

NUMBER <b>GS-12-651</b>	TYPE <b>PRODUCT SPECIFICATION</b>		
TITLE <b>MINI-SAS HD External Cable to Board Connector System</b>		PAGE 5 of 14	REVISION F
		AUTHORIZED BY Roger Cheng	DATE 2013-12-19
		CLASSIFICATION <b>UNRESTRICTED</b>	

## 8.0 MECHANICAL REQUIREMENTS

### 8.1 Mating / Un-mating forces

The performance testing with completed assemblies. The force to mate a cable connector with a corresponding board connector shall not exceed 1.7 N per contact. The un-mating force shall not exceed 0.8 N per contact. Connectors shall be mated at a rate of 25 mm per minute; measure the force of mating contacts and un-mating before and after durability.

### 8.2 Latch Mating Force

The force to mate a cable connector with the latch engaged to a corresponding board connector shall be 10 N maximum per module in addition to the maximum contact mating force of 1.7 N per contact as specified per section 8.1 (Mating / Un-mating Forces).

### 8.3 De-Latching Force

The force to de-latch a cable connector from a corresponding board connector shall be 10 N maximum in addition to the maximum contact un-mating force of 0.0.8 N per contact as specified per section 8.1 (Mating / Un-mating Forces).

### 8.4 Latch Tab Pull Strength

The latch pull tab on the cable connector shall withstand a minimum of an 89 N force when an axial load is placed on the tab with the 6.35 mm diameter pin.

### 8.5 Latched Retention (Cable Connector Retention in Cage)

The mated cable connector, with latch engaged, shall withstand a minimum force of 75 N without separation when an axial load is applied directly to the cable. Force shall be applied at a rate of 25mm per minute.

### 8.6 Cable Jacket Retention

With the plug connector fixed, an axial load of 100 N shall be applied to the cable for 20 seconds without loss of electrical continuity. Movement of the cable jacket (as measured from the back of the plug connector) after removal of the load shall not exceed 1 mm from its initial position.

### 8.7 Wire Flex

Testing shall be performed in accordance with Type C EIA 364-41, test condition I. The cable shall show no physical damage and maintain proper impedance as specified in section 7.4 after being flexed 180°, 25 times as specified in Table 1. Load applied to cable shall be 4.4 N. Monitor for microsecond discontinuities throughout flexing. No microsecond discontinuities are allowed.

Raw Cable AWG	Minimum Bending Radius Repeated
30AWG	25mm
28AWG	25mm
26AWG	37mm
24AWG	37mm

\* Refer to SFF-8417 for non-standard cable sizes

**Table 1 – Cable Minimum Bend Radius**

NUMBER <b>GS-12-651</b>	TYPE <b>PRODUCT SPECIFICATION</b>		
TITLE <b>MINI-SAS HD External Cable to Board Connector System</b>		PAGE <b>6 of 14</b>	REVISION <b>F</b>
		AUTHORIZED BY <b>Roger Cheng</b>	DATE <b>2013-12-19</b>
		CLASSIFICATION <b>UNRESTRICTED</b>	

**8.8 Press-Fit Insertion Forces**

Press fit pins of the contact terminals shall be inserted into standard size plated through holes at a rate of 25 mm/min in accordance with IEC 60352-5, Section 5.2.2.2. The maximum insertion force shall be 18 N per press fit pin on the first insertion.

**8.9 Press-Fit Withdrawal Forces**

Press fit pins of the contact terminals shall be removed from standard size plated through holes at a rate of 10 mm/min in accordance with IEC 60352-5, Section 5.2.2.3 except that receptacle modules or subassemblies thereof shall be pulled (rather than pushed) off. The minimum withdrawal force shall be 3 N per press fit pin after repair (on the third removal).

**8.10 Connector Longitudinal Loading**

Mated connectors shall withstand a minimum force of 75 N without electrical discontinuity when tested as shown in the figure 1 shown below. Force shall be applied at a rate of 25mm per minute with a 6mm diameter pin (with a full radius tip).

For a 1x4 connector, test in port 1 and port 3.

For a 1x2 connector, test in port 1

For a 1x1 connector, test in port 1.

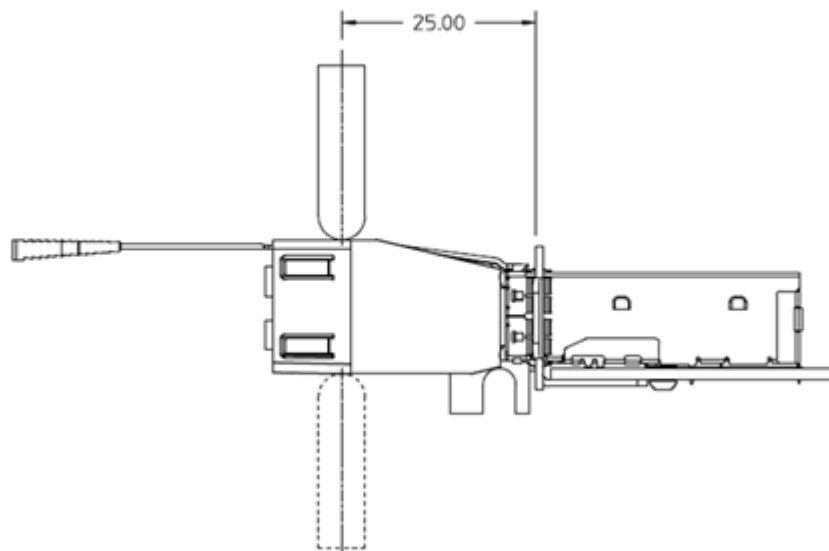

**Figure 1: Longitudinal Loading**

NUMBER <b>GS-12-651</b>	TYPE <b>PRODUCT SPECIFICATION</b>	<b>FCI</b>	
TITLE <b>MINI-SAS HD External Cable to Board Connector System</b>		PAGE <b>7 of 14</b>	REVISION <b>F</b>
		AUTHORIZED BY <b>Roger Cheng</b>	DATE <b>2013-12-19</b>
		CLASSIFICATION <b>UNRESTRICTED</b>	

### 8.11 Connector Latitudinal Loading

Mated connectors shall withstand a minimum force of 75 N without electrical discontinuity when tested as shown in the figure 2 shown below. Force shall be applied at a rate of 25mm per minute with a 6mm diameter pin (with a full radius tip).

For a 1x4 connector, test in port 1 and port 3.

For a 1x2 connector, test in port 1

For a 1x1 connector, test in port 1.

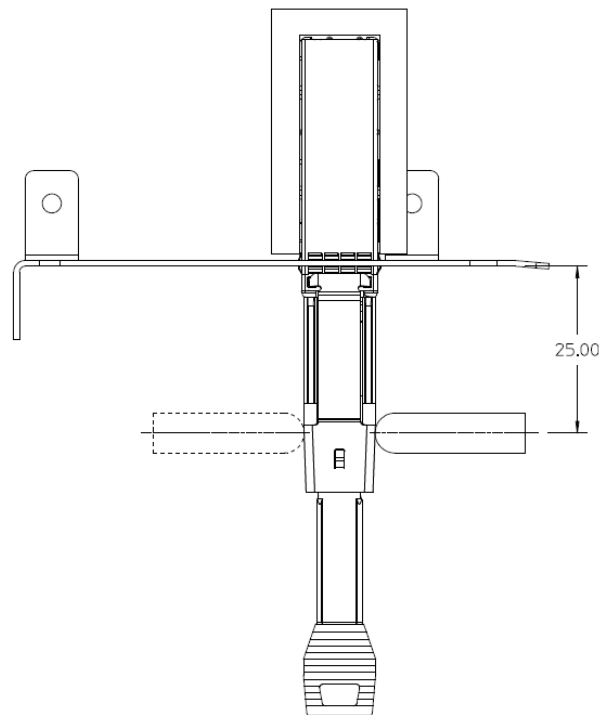

**Figure 2: Latitudinal Loading**

### 8.12 Right Angle Pull Out

- Mate plug to connector and apply a right angle pullout force on the wire at a rate of 25 mm per min. The mated connector, with latch engaged, shall withstand a minimum force of 75 N without separation.

### 8.13 Durability

Perform in accordance with EIA 364-09C. Use standard laboratory procedure as applicable to the product. The following details shall apply:

- Number of cycles: 250 total mating cycles
- Cycling rate: 125 mm per minute
- No physical damage
- Maximum change in contact resistance of 10 mΩ

NUMBER <b>GS-12-651</b>	TYPE <b>PRODUCT SPECIFICATION</b>		
TITLE <b>MINI-SAS HD External Cable to Board Connector System</b>		PAGE <b>8 of 14</b>	REVISION <b>F</b>
		AUTHORIZED BY <b>Roger Cheng</b>	DATE <b>2013-12-19</b>
		CLASSIFICATION <b>UNRESTRICTED</b>	

#### 8.14 Durability Pre-conditioning

Perform in accordance with EIA 364-09C. Use standard laboratory procedure as applicable to the product. The following details shall apply:

- Number of cycles: 50 total mating cycles
- Cycling rate: 125 mm per minute
- No evidence of physical damage

#### 8.15 Screw Torque

The mounting screw on the receptacle connector shall withstand a torque of 200 N-mm minimum without stripping of the screw threads.

#### 8.16 PCB PTH Degradation

##### 8.16.1 PTH Radial Deformation

Measure the maximum radial deformation of the drilled hole surface of the plated through hole (PTH) after the third pin insertion in accordance with IEC 60352-5, Section 5.2.2.5.1. Measurements shall be made on a transverse cross section approximately 0.3 mm from the top (connector side) surface of the printed wiring board. A minimum of ten (10) holes shall be measured. The radial deformation shall be 70 micrometers maximum.

##### 8.16.2 PTH Remaining Copper Thickness

Measure the minimum copper thickness remaining in the PTH after the third pin insertion in accordance with IEC 60352-5, Section 5.2.2.5.1. Measurements shall be made on a transverse cross section approximately 0.3 mm from the top (connector side) surface of the printed wiring board. A minimum of ten (10) holes shall be measured. The remaining copper thickness shall be 8 micrometers minimum. There shall be no cracks in the copper plating.

##### 8.16.3 PTH Wall Damage

The PTH, annulus, and connecting traces shall be examined for damage on a longitudinal cross section through the compliant feature of the pin after the third pin insertion in accordance with IEC 60352-5, Section 5.2.2.5.2. A minimum of ten (10) holes shall be examined. The axial deformation of connecting traces shall be 50 micrometers maximum. There shall be no cracks in the copper plating.

### 9.0 ENVIRONMENTAL REQUIREMENTS

#### 9.1 Temperature Life

Perform in accordance with EIA 364-17, Method A, test condition 4. Cable and board connector shall remain mated without any electrical load and following details shall apply:

- Temperature: 105°C ± 2°C
- Duration: 840 hours
- No changes in contact resistance greater than 10mΩ

#### 9.2 Temperature Life Preconditioning

Perform in accordance with EIA 364-17, Method A, test condition 4. Cable and board connector shall remain mated without any electrical load. The following details shall apply:

- Temperature: 105°C ± 2°C
- Duration: 336 hours



NUMBER <b>GS-12-651</b>	TYPE <b>PRODUCT SPECIFICATION</b>		
TITLE <b>MINI-SAS HD External Cable to Board Connector System</b>		PAGE 9 of 14	REVISION F
		AUTHORIZED BY Roger Cheng	DATE 2013-12-19
		CLASSIFICATION <b>UNRESTRICTED</b>	

### 9.3 Thermal Shock

Perform in accordance with EIA 364-32, method A, condition 1, duration A-3. The following details shall apply:

- Number of cycles: 100
- Temperature range: -55 to + 85°C
- Time at each temperature: 30 minutes minimum
- Transfer time: 30 seconds maximum

### 9.4 Cyclical Humidity and Temperature

Samples are to be exposed to cyclical humidity and temperature in accordance with EIA 364-31, Method III, except for profile and duration as follows. Samples are to be subjected to 50 cycles of 10 hour duration for a total of 500 hours.

A cycle consists of the following steps:

- 2 hour ramp from 25°C to 65°C at 90 % to 98 % RH
- 4 hour dwell at 65°C, 90 % to 98 % RH
- 2 hour ramp down from 65°C to 25°C at 80 % to 98 % RH
- 2 hour dwell at 25°C, 90 % to 98 % RH

### 9.5 Mechanical Vibration

Perform in accordance with EIA 364-28, Test Condition 7D. Mated samples are subjected to 3.1 G rms between 20 and 500 Hz for 15 minutes in each of 3 mutually perpendicular planes. Both mating halves of samples are to be rigidly mounted. No discontinuities greater than 1 micro-second are to occur during testing. The maximum change in contact resistance shall be less than 10 mΩ.

### 9.6 Mixed Flowing Gas (MFG)

Perform in accordance with EIA 364-65. Unmated board connectors shall be subjected to environmental class IIA gas exposure for 224 hours with half of the samples mated, and half unmated (receptacle exposed) followed by an additional 112 hours with all samples mated.

### 9.7 Thermal Disturbance

Samples are to be cycled 10 times between 15±3°C and 85±3°C. Ramp rate shall be a minimum of 2°C per minute. Dwell time shall be a minimum of 5 minutes at each temperature extreme.

### 9.8 Reseat

Manually unmate and remate the connector pair 3 times.

### 9.9 Connector Repair

Connector repair is conducted in accordance with IEC 60352-5, Section 5.2.2.6. After initial connector insertion, the connector is removed and replaced with a new connector (in the same PTHs). This second connector is removed and replaced with a new connector (in the same PTHs). This third connector is left in place on the printed wiring board for assessment of PTH integrity (radial deformation, remaining copper thickness, and wall damage) or is removed for measurement of final press fit retention force. There shall be no damage to the printed wiring board detrimental to function.

NUMBER <b>GS-12-651</b>	TYPE <b>PRODUCT SPECIFICATION</b>		
TITLE <b>MINI-SAS HD External Cable to Board Connector System</b>		PAGE 10 of 14	REVISION F
		AUTHORIZED BY Roger Cheng	DATE 2013-12-19
		CLASSIFICATION <b>UNRESTRICTED</b>	

## 10.0 QUALITY ASSURANCE PROVISIONS

### 10.1 Equipment Calibration

All test equipment and inspection facilities used in the performance of any test shall be maintained in a calibration system in accordance with Mil-C-45622.

### 10.2 Inspection Conditions

Unless otherwise specified herein, all inspections shall be performed under the following ambient conditions:

- Temperature:  $25 \pm 5^\circ \text{C}$ .
- Relative Humidity: 20% to 60%
- Barometric pressure: Local ambient

### 10.3 Sample Quantity and Description

Samples used for qualification testing shall be samples that were manufactured using standard production equipment and procedures. The quantity of samples needed for each test sequence is shown in Table 3.

### 10.4 Acceptance

Electrical and mechanical requirements placed on test samples as indicated in the sections of this specification shall be established from test data using appropriate statistical techniques or shall otherwise be customer specified, and all samples tested in accordance with this product specification shall meet the stated requirements.

Failures attributed to equipment, test set-up or operator error shall not disqualify the product. If product failure occurs, corrective action shall be taken and samples resubmitted for qualification.

### 10.5 Qualification Testing

Qualification testing shall be performed on samples that were produced with equipment and procedures used in normal production. Testing shall be performed per the test sequences shown in Table 2.

### 10.6 Re-qualification testing

If any of the following conditions occur, the responsible Product Engineer shall initiate re-qualification testing consisting of all applicable test sequences shown in Table 2.

- A significant design change is made to existing product, which impacts product form, fit or function. Examples of significant change include, but shall not be limited to, changes made to the contact plating, base material or base material composition of any component, contact interface geometry, etc.
- A significant change is made to the manufacturing process, which impacts the product form, fit or function.
- A significant event occurs during production or end use requiring corrective action to be taken relative to the product design or manufacturing process.

NUMBER <b>GS-12-651</b>	TYPE <b>PRODUCT SPECIFICATION</b>		
TITLE <b>MINI-SAS HD External Cable to Board Connector System</b>		PAGE <b>11 of 14</b>	REVISION <b>F</b>
		AUTHORIZED BY <b>Roger Cheng</b>	DATE <b>2013-12-19</b>
		CLASSIFICATION <b>UNRESTRICTED</b>	

TEST GROUP		1	2	3	4	5	6	7	8	9	10	11
TEST DESCRIPTION	SECTION	Latched Cable Retention	Cable Flex	Temp Life	Thermal Shock & Humidity	Corrosion Resistance	Vibration	Durability	Current Rating	Connector Loading	Bracketed Connector Loading	Compliant Pin Force
Visual Examination	5.2	1,5	1,6	1,11	1,13	1,17	1,11	1,9	1,3	1,6	1	1,6
Low Level Contact Resistance (LLCR)	7.1			2,6,8,10	2,4,8,10,12	2,6,8,10,12,14,16	2,6,8,10	2,7				
Dielectric Withstanding Voltage (DWV)	7.2							3,8				
Current Cycling/T-rise	7.3								2			
Differential Impedance	7.4	2,4	2,4									
Mating / Un-mating Forces	8.1			3,5	5,7	3,5	3,5	4,6				
Latched Mating Force	8.2									2		
De-Latching Force	8.3									3		
Latch Tab Pull Strnength	8.4									4		
Latched Retention (Cable Connector Retention in Cage)	8.5	3										
Cable Jacket Retention	8.6		5									
Wire Flex	8.7		3									
Press Fit Insertion Force	8.8											2
Press Fit Removal Force	8.9											5
Connector Longitudinal Loading	8.10										3	
Connector Latitudinal Loading	8.11										2	
RA plug Pullout	8.12										4	
Durability (250 Cycles)	8.13							5				
Durability Preconditioning (50 Cycles)	8.14			4	6	4	4					
Screw Torque	8.15									5		
PCB PTH Degradation	8.16											4
Temperature Life (840 hr)	9.1			7								
Thermal Preconditioning (336 hr)	9.2					7	7					
Thermal Shock	9.3				3							
Cylical Humidity and Temperature	9.4				9							
Mechanical Vibration	9.5						9					
MFG (½ Mated, ½ Unmated, 224 hr)	9.6					9						
MFG (Mated, 112 hr)	9.6					11						
Thermal Disturbance	9.7					13						
Reseat	9.8			9	11	15						
Connector Repair	9.9											3

**Table 2 – Product Test Sequences**

NUMBER <b>GS-12-651</b>	TYPE <b>PRODUCT SPECIFICATION</b>		
TITLE <b>MINI-SAS HD External Cable to Board Connector System</b>		PAGE 12 of 14	REVISION F
		AUTHORIZED BY Roger Cheng	DATE 2013-12-19
CLASSIFICATION <b>UNRESTRICTED</b>			

Test Group	Number of Cables Ends	Cables Description	Number of Board Connector Ports
1	6	Any AWG, single ended, 0.5 meter	3
2	6	Each AWG, single ended, 0.5 meter	1
3	5	Any AWG, single ended, 0.5 meter	5
4	5	Any AWG, single ended, 0.5 meter	5
5	10	Any AWG, single ended, 0.5 meter	10
6	12	Largest AWG, single ended, 0.5 meter	3 1x4
7	5	Any AWG, single ended, 0.5 meter	5
8	4	Smallest AWG, single ended, 0.5 meter	1 1x4
9	3	Any AWG, single ended, 0.5 meter	3
10	12	Any AWG, single ended, 0.5 meter	3 each size
11	--	--	5 Boards, 15 Connectors

**Table 3 – Product Test Sample Quantities**

**NOTE:** For qualification test samples, DC blocking capacitors on the receive channels are to be replaced by 0 ohm resistors so that LLCR measurements can be taken on the receive channels.

NUMBER <b>GS-12-651</b>	TYPE <b>PRODUCT SPECIFICATION</b>	<b>FCI</b>	
TITLE <b>MINI-SAS HD External Cable to Board Connector System</b>		PAGE <b>13 of 14</b>	REVISION <b>F</b>
		AUTHORIZED BY <b>Roger Cheng</b>	DATE <b>2013-12-19</b>
		CLASSIFICATION <b>UNRESTRICTED</b>	

## 11.0 SUPPORTING INFORMATION

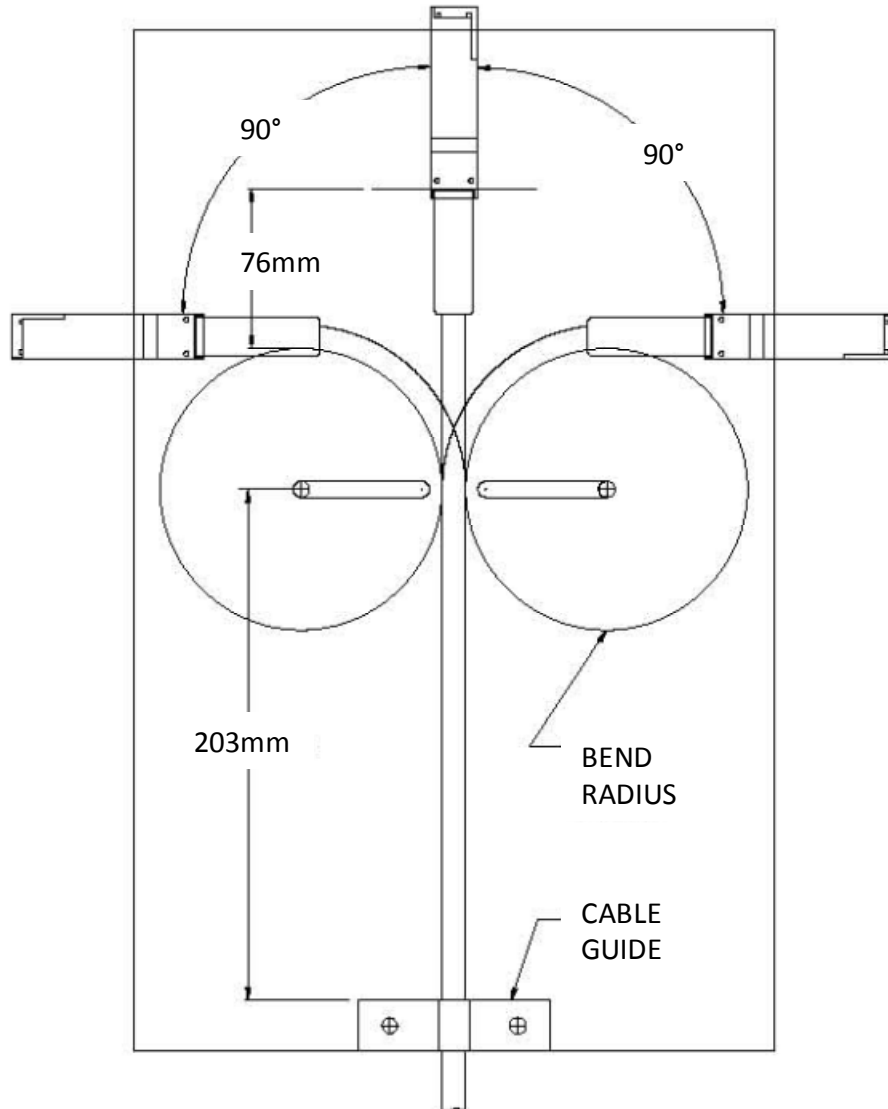

**Figure 3 – Repeated Wire Flex Test  
(See Mechanical Characteristics 8.7 and Table 1)**

NUMBER <b>GS-12-651</b>	TYPE <b>PRODUCT SPECIFICATION</b>		
TITLE <b>MINI-SAS HD External Cable to Board Connector System</b>		PAGE <b>14 of 14</b>	REVISION <b>F</b>
		AUTHORIZED BY <b>Roger Cheng</b>	DATE <b>2013-12-19</b>
CLASSIFICATION <b>UNRESTRICTED</b>			



## 12.0 EEPROM INFORMATION FOR MSHD cable ass'y

The MSHD serial ID provides access to sophisticated identification information that describes the Transceiver's capabilities, standard interfaces, manufacturer, and other information. The EEPROM on the MSHD passive cable assembly is designed for 255 addresses. This information can be tailored to FCI specification.

See attached file for detail information about the EEPROM .



FCIStdEppromTemp\_minisashD\_RevA.xl



FCIStdEppromTemp\_minisashD\_RevA.pd

## 13.0 REVISION RECORD

REV	PAGE	DESCRIPTION	EC #	DATE
A	All	Initial Release		2011-11-22
B	4-6,12	Sections 3.3, 7.4, 8.5, 8.7, Test sequence 10	ECN-ELX-V-010322	2012-02-17
C	6,8,9,11	Sections 8.5, 8.8, 8.9, Test Sequence 11; Add 8.16, 9.9	ECN-ELX-V-010479	2012-03-03
D	3	Sections 3.3 to add 14G Mini-SAS cable assembly Flex test report number	ECN-ELX-N-16200-1	2013-11-06
E		Upload correct document to Rev.D	ECN-ELX-N-16208-1	2013-11-07
F	14	Add EEPROM information for MSHD cable ass'y	ECN-ELX-N-16545-1	2013-12-19