

## SMF4L Series

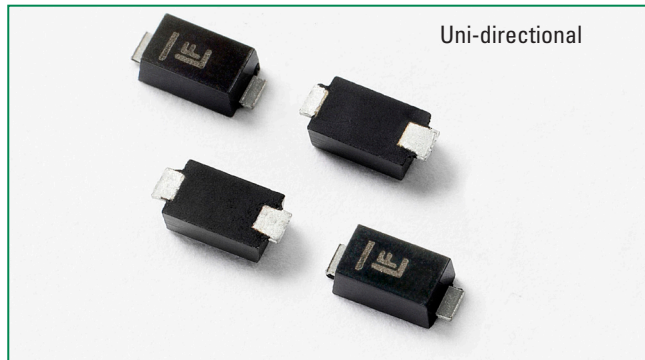

### Agency Approvals

AGENCY	AGENCY FILE NUMBER
	E230531

### Maximum Ratings and Thermal Characteristics ( $T_A=25^\circ\text{C}$ unless otherwise noted)

Parameter	Symbol	Value	Unit
Peak Pulse Power Dissipation at $T_A=25^\circ\text{C}$ (Note 1)	8/20 $\mu\text{s}$ (Note 2)	2000	W
	10/1000 $\mu\text{s}$ (Note 3)	400	W
Thermal Resistance Junction to Ambient	$R_{\theta JA}$	220	$^\circ\text{C/W}$
Thermal Resistance Junction to Lead	$R_{\theta JL}$	100	$^\circ\text{C/W}$
Operating and Storage Temperature Range	$T_J, T_{STG}$	-55 to 150	$^\circ\text{C}$

**Notes:**

1. Non-repetitive current pulse, per Fig. 4 and derated above  $T_J$  (initial) =  $25^\circ\text{C}$  per Fig. 3.
2. SMF4L5.0A~SMF4L9.0A Peak Pulse Power Dissipation is 1850W min, 2000W typical @8/20 $\mu\text{s}$
3. SMF4L5.0A~SMF4L9.0A Peak Pulse Power Dissipation is 370W min, 400W typical @ 10/1000 $\mu\text{s}$

### Functional Diagram

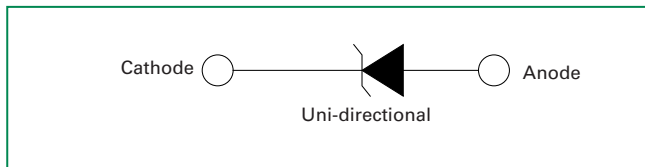

### Description

The SMF4L series of SOD-123FL small and flat lead low-profile plastic package is designed specifically to protect sensitive electronic equipment from voltage transients induced by lightning and other transient voltage events.

### Features

- 400W peak pulsepower capability at 10/1000 $\mu\text{s}$  waveform, repetition rate (duty cycle): 0.01 %
- Compatible with industrial standard package SOD-123FL
- Low profile: maximum height of 0.98mm.
- Low inductance, excellent clamping capability
- For surface mounted applications to optimize board space
- Typical failure mode is short from over-specified voltage or current
- Whisker test is conducted based on JEDEC JESD201A per its table 4a and 4c
- IEC-61000-4-2 ESD 30kV(Air), 30kV (Contact)
- ESD protection of data lines in accordance with IEC 61000-4-2
- EFT protection of data lines in accordance with IEC 61000-4-4
- Fast response time: typically less than 1.0ns from 0 Volts to  $V_{BR}$  min
- High temperature soldering: 260 $^\circ\text{C}/40$  seconds at terminals
- Glass passivated junction
- Built-in strain relief
- Plastic package is flammability rated V-0 per Underwriters Laboratories
- Meet MSL level1, per J-STD-020, LF maximum peak of 260 $^\circ\text{C}$
- Matte tin lead-free plated
- Halogen-free and RoHS compliant
- Pb-free E3 means 2<sup>nd</sup> level interconnect is Pb-free and the terminal finish material is tin(Sn) (IPC/ JEDEC J-STD-609A.01)

### Applications

SMF4L devices are ideal for the protection of portable devices/hard drives, notebooks,  $V_{CC}$  busses, POS terminal, SSDs, power supplies, monitors, and vulnerable circuit used in other consumer applications.

**Electrical Characteristics** ( $T_A=25^\circ\text{C}$  unless otherwise noted)

Part Number	Marking Code	Breakdown Voltage $V_{BR}$ (Volts) @ $I_T$		Test Current $I_T$ (mA)	Reverse Stand off Voltage $V_R$ (V)	Maximum Reverse Leakage @ $V_R$ $I_R$ ( $\mu\text{A}$ )	Maximum Peak Pulse Current $I_{pp}$ (A)	Maximum Clamping Voltage @ $I_{pp}$ $V_C$ (V)	Agency Approval 
		MIN	MAX						
SMF4L5.0A	KE	6.40	7.00	10	5.0	800	40.1	9.2	X
SMF4L6.0A	KG	6.67	7.37	10	6.0	800	35.9	10.3	X
SMF4L6.5A	KK	7.22	7.98	10	6.5	500	33.1	11.2	X
SMF4L7.0A	KM	7.78	8.60	10	7.0	200	30.9	12.0	X
SMF4L7.5A	KP	8.33	9.21	1	7.5	100	28.7	12.9	X
SMF4L8.0A	KR	8.89	9.83	1	8.0	50	27.2	13.6	X
SMF4L8.5A	KT	9.44	10.40	1	8.5	20	25.7	14.4	X
SMF4L9.0A	KV	10.00	11.10	1	9.0	10	24.1	15.4	X
SMF4L10A	KX	11.10	12.30	1	10	5	23.5	17.0	X
SMF4L11A	KZ	12.20	13.50	1	11	1	22.0	18.2	X
SMF4L12A	LE	13.30	14.70	1	12	1	20.1	19.9	X
SMF4L13A	LG	14.40	15.90	1	13	1	18.6	21.5	X
SMF4L14A	LK	15.60	17.20	1	14	1	17.2	23.2	X
SMF4L15A	LM	16.70	18.50	1	15	1	16.4	24.4	X
SMF4L16A	LP	17.80	19.70	1	16	1	15.4	26.0	X
SMF4L17A	LR	18.90	20.90	1	17	1	14.5	27.6	X
SMF4L18A	LT	20.00	22.10	1	18	1	13.7	29.2	X
SMF4L20A	LV	22.20	24.50	1	20	1	12.3	32.4	X
SMF4L22A	LX	24.40	26.90	1	22	1	11.3	35.5	X
SMF4L24A	LZ	26.70	29.50	1	24	1	10.3	38.9	X
SMF4L26A	ME	28.90	31.90	1	26	1	9.5	42.1	X
SMF4L28A	MG	31.10	34.40	1	28	1	8.8	45.4	X
SMF4L30A	MK	33.30	36.80	1	30	1	8.3	48.4	X
SMF4L33A	MM	36.70	40.60	1	33	1	7.5	53.3	X
SMF4L36A	MP	40.00	44.20	1	36	1	6.9	58.1	X
SMF4L40A	MR	44.40	49.10	1	40	1	6.2	64.5	X
SMF4L43A	MT	47.80	52.80	1	43	1	5.8	69.4	X
SMF4L45A	MV	50.00	55.30	1	45	1	5.5	72.7	X
SMF4L48A	MX	53.30	58.90	1	48	1	5.2	77.4	X
SMF4L51A	MZ	56.70	62.70	1	51	1	4.9	82.4	X
SMF4L54A	NE	60.00	66.30	1	54	1	4.6	87.1	X
SMF4L58A	NG	64.40	71.20	1	58	1	4.3	93.6	X
SMF4L60A	NK	66.70	73.70	1	60	1	4.1	96.8	X
SMF4L64A	NM	71.10	78.60	1	64	1	3.9	103.0	X
SMF4L70A	NP	77.80	86.00	1	70	1	3.5	113.0	X
SMF4L75A	NR	83.30	92.10	1	75	1	3.3	121.0	X
SMF4L78A	NT	86.70	95.80	1	78	1	3.2	126.0	X
SMF4L85A	NV	94.40	104.00	1	85	1	2.9	137.0	X

**Notes:**

- $V_{BR}$  measured after  $I_T$  applied for 300 $\mu\text{s}$ ,  $I_T$  = square wave pulse or equivalent.
- Surge current waveform per 10/1000 $\mu\text{s}$  exponential wave and derated per Fig.2.
- All terms and symbols are consistent with ANSI/IEEE C62.35.

**I-V Curve Characteristics**

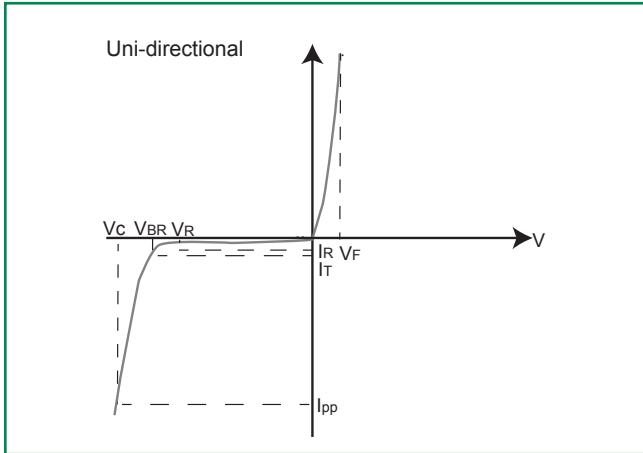

- P<sub>PPM</sub> Peak Pulse Power Dissipation** – Max power dissipation
- V<sub>R</sub> Stand-off Voltage** – Maximum voltage that can be applied to the TVS without operation
- V<sub>BR</sub> Breakdown Voltage** – Maximum voltage that flows through the TVS at a specified test current (I<sub>T</sub>)
- V<sub>C</sub> Clamping Voltage** – Peak voltage measured across the TVS at a specified I<sub>ppm</sub> (peak impulse current)
- I<sub>R</sub> Reverse Leakage Current** – Current measured at V<sub>R</sub>
- V<sub>F</sub> Forward Voltage Drop for Uni-directional**

**Ratings and Characteristic Curves (T<sub>A</sub>=25°C unless otherwise noted)**

**Figure 1 - TVS Transients Clamping Waveform**

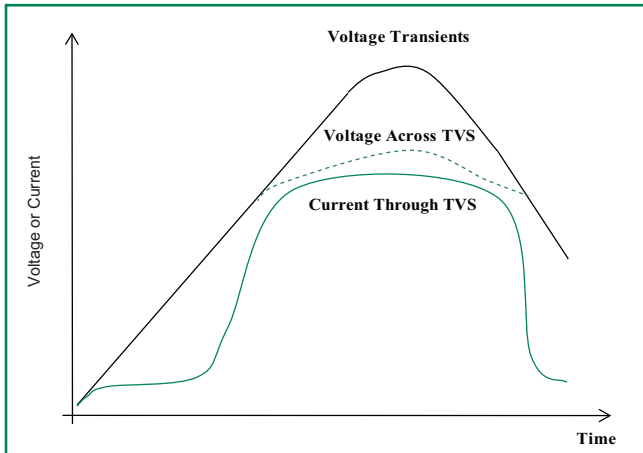

**Figure 2 - Peak Pulse Power Rating Curve**

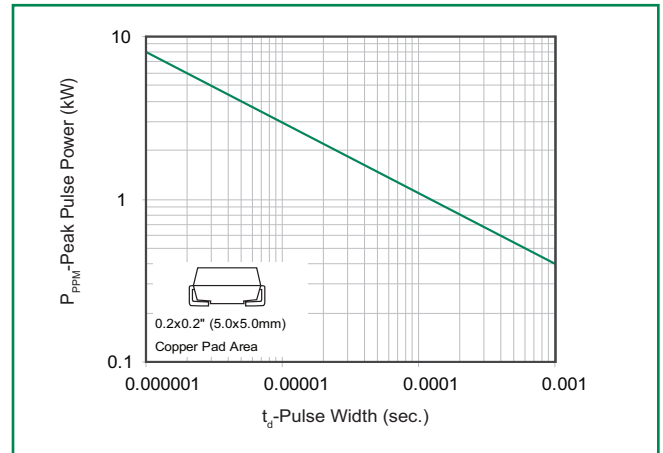

continues on next page.

**Ratings and Characteristic Curves** ( $T_A=25^\circ\text{C}$  unless otherwise noted) (Continued)

**Figure 3 - Peak Pulse Power Derating Curve**

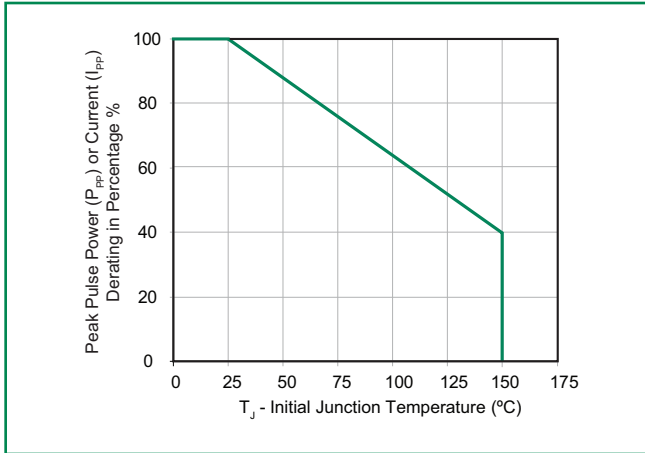

**Figure 4 - Pulse Waveform - 10/1000 $\mu$ S**

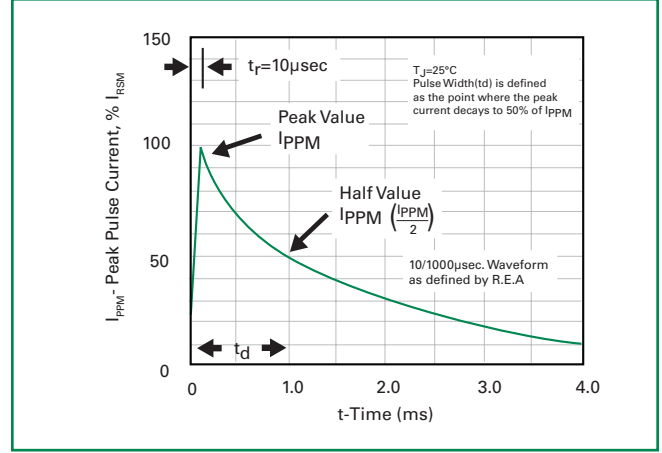

**Figure 5 - Forward Voltage**

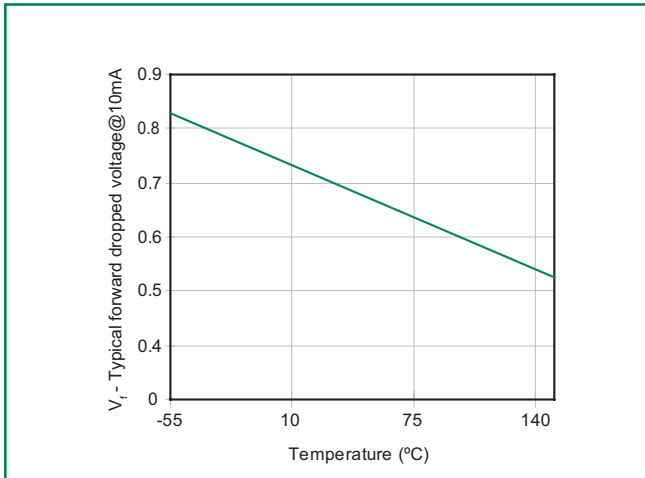

**Figure 6 - Typical Junction Capacitance**

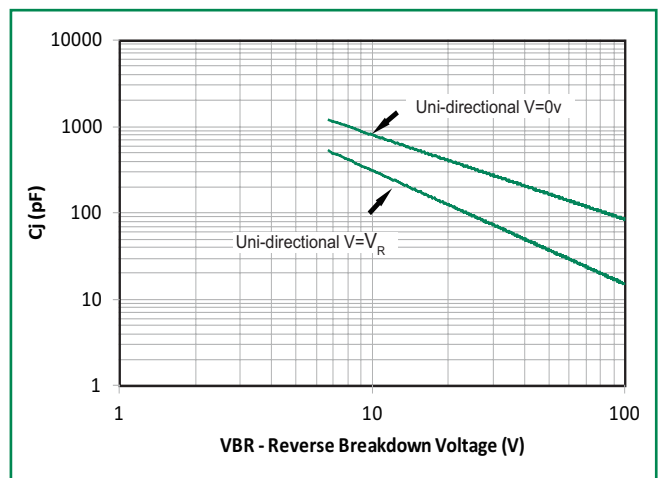

**Figure 7 - Peak Forward Voltage Drop vs. Peak Forward Current**

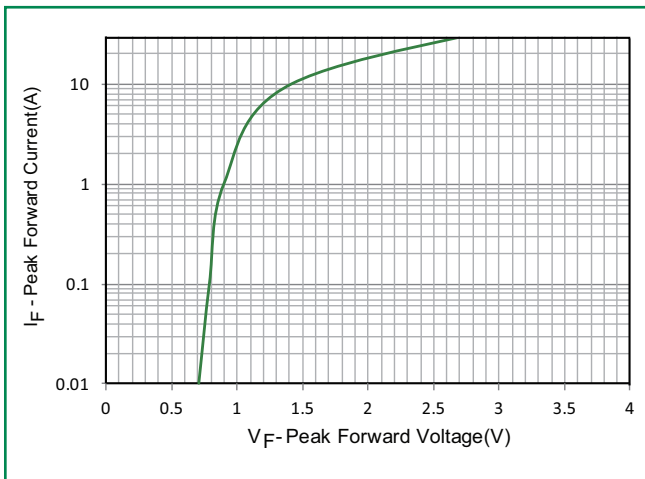
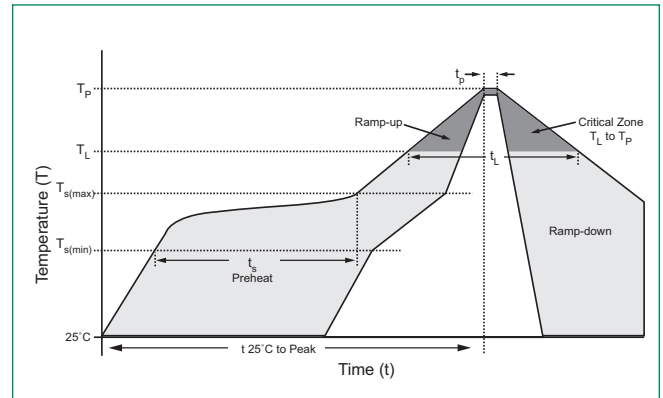

**Figure 8 - Maximum Non-Repetitive Forward Surge Current Uni-Directional Only**



**Soldering Parameters**

Reflow Condition		Lead-free assembly
Pre Heat	- Temperature Min ( $T_{s(min)}$ )	150°C
	- Temperature Max ( $T_{s(max)}$ )	200°C
	- Time (min to max) ( $t_s$ )	60 – 180 secs
Average ramp up rate (Liquidus Temp ( $T_A$ ) to peak)		3°C/second max
$T_{s(max)}$ to $T_A$ - Ramp-up Rate		3°C/second max
Reflow	- Temperature ( $T_A$ ) (Liquidus)	217°C
	- Time (min to max) ( $t_s$ )	60 – 150 seconds
Peak Temperature ( $T_p$ )		260 <sup>+0/-5</sup> °C
Time within 5°C of actual peak Temperature ( $t_p$ )		20 – 40 seconds
Ramp-down Rate		6°C/second max
Time 25°C to peak Temperature ( $T_p$ )		8 minutes Max.
Do not exceed		260°C



**Physical Specifications**

<b>Case</b>	SOD-123FL plastic over glass passivated junction
<b>Polarity</b>	Color band denotes cathode except bipolar
<b>Terminal</b>	Matte tin-plated leads, solderable per JESD22-B102

**Environmental Specifications**

<b>High Temp. Storage</b>	JESD22-A103
<b>HTRB</b>	JESD22-A108
<b>Temperature Cycling</b>	JESD22-A104
<b>MSL</b>	JEDEC-J-STD-020, Level 1
<b>H3TRB</b>	JESD22-A101
<b>RSH</b>	JESD22-A111

**Dimensions - SOD-123FL Package**

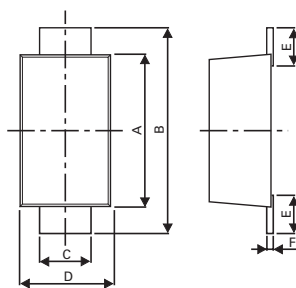

**Mounting Pad Layout**

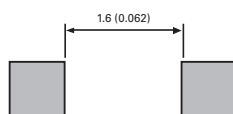

Dimensions	Millimeters		Inches	
	Min	Max	Min	Max
A	2.90	3.10	0.114	0.122
B	3.50	3.90	0.138	0.154
C	0.85	1.05	0.033	0.041
D	1.70	2.00	0.067	0.079
E	0.43	0.83	0.017	0.033
F	0.10	0.25	0.004	0.010
G	0.00	0.10	0.000	0.004
H	0.90	0.98	0.035	0.039

**Part Numbering System**

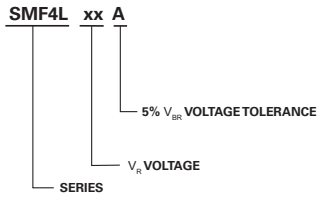

**Part Marking System**

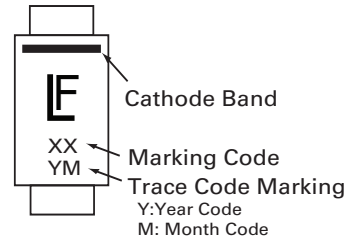

**Packaging Options**

Part number	Component Package	Quantity	Packaging Option	Packaging Specification
SMF4LXXX	SOD-123FL	3000	Tape & Reel – 8mm tape/7" reel	EIA RS-481

**Tape and Reel Specification**

