

## Adafruit I2S Stereo Decoder - UDA1334A

Created by lady\_ada

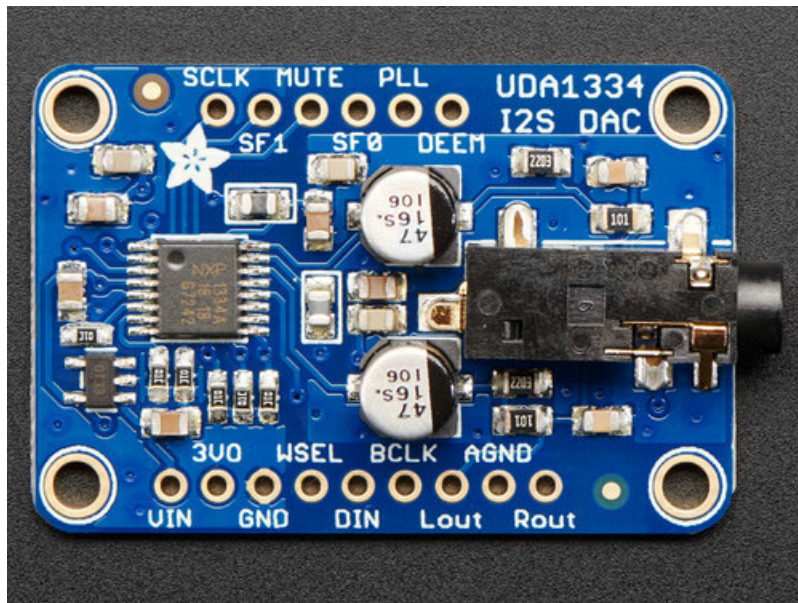

Last updated on 2020-06-15 04:21:25 PM EDT

## Overview

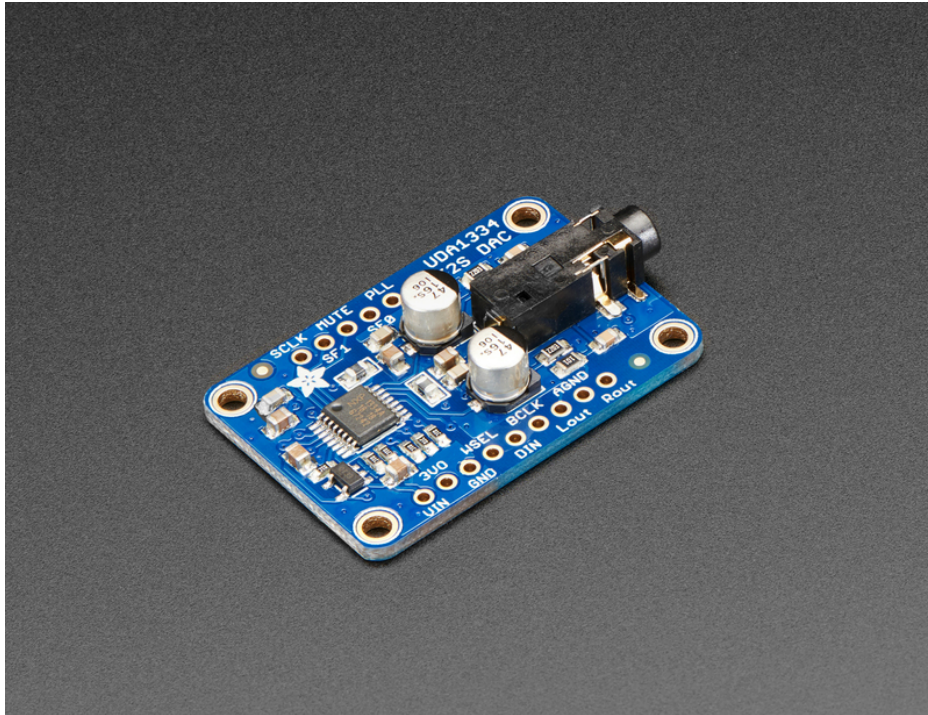

This fully-featured UDA1334A I2S Stereo DAC breakout is a perfect match for any I2S-output audio interface. It's affordable but sounds great! The NXP UDA1334A is a jack-of-all-I2S-trades: you can use 3.3V - 5V logic levels (a rarity), and can process multiple different formats by setting two pins to high or low. The DAC will process data immediately, and give you a clear, analog, stereo line level output. It's even cool with MCLK-less I2S interfaces such as the Raspberry Pi (which it's ideal for) - a built in PLL will generate the proper clock from the incoming signal.

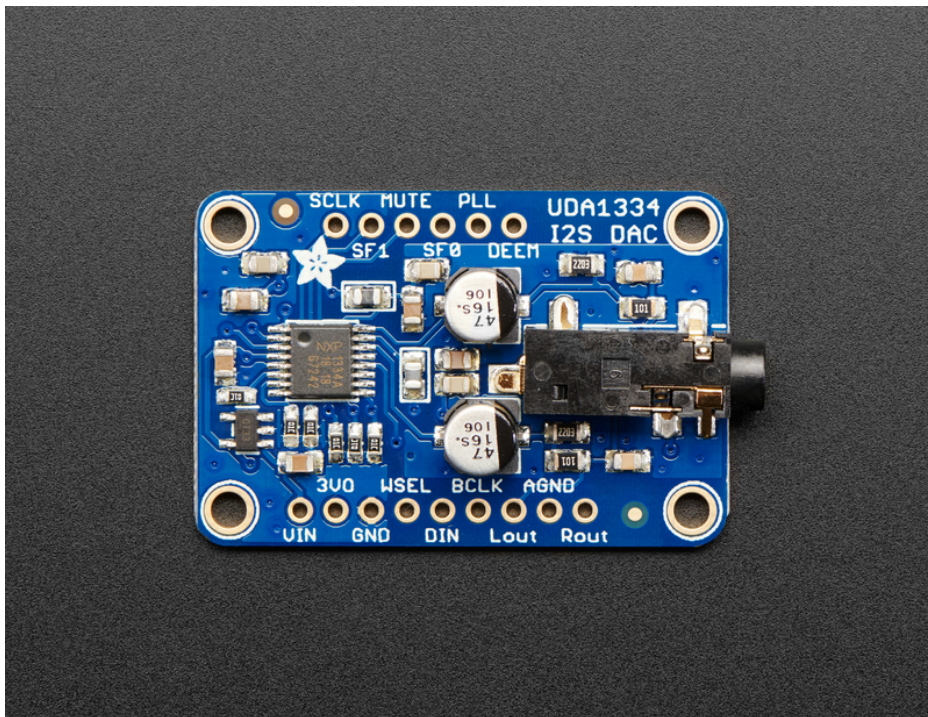



For inputs, you can use classic I2S (the default) or 16-bit, 20-bit or 24-bit left justified data. You can set it up to take an input system/main clock but we default-set it to just generate it for you, so you only need to connect Data In, Word Select (Left/Right Clock) and Bit Clock lines. If you want, there's a mute pin and a de-emphasis filter you can turn on.

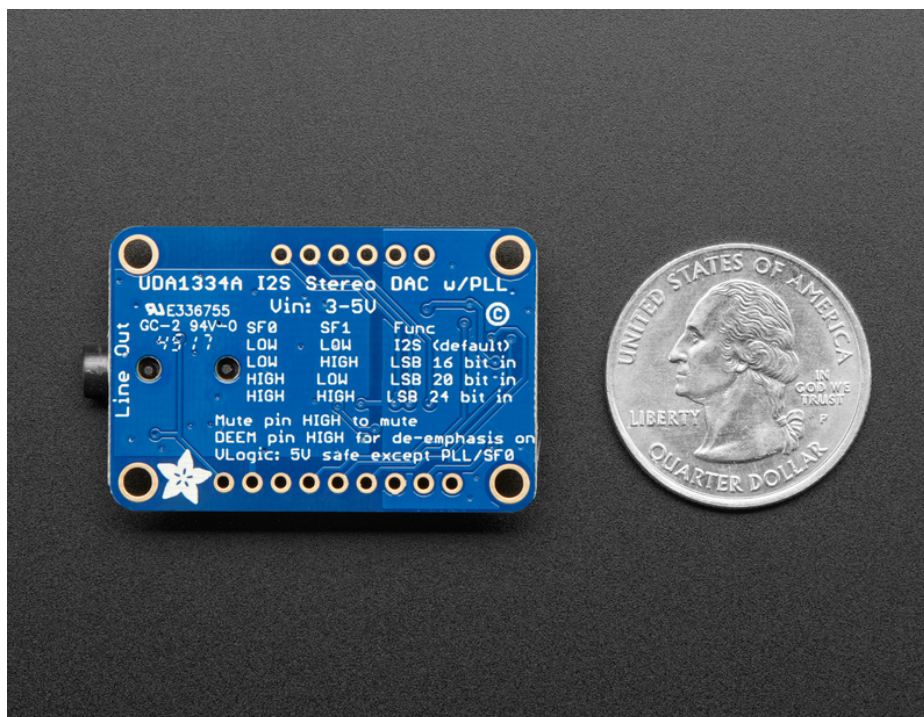

We put in plenty of ferrite beads, a low-dropout regulator, and the recommended band-pass filter so you get a very nice clean output. With a sine-wave generator we swept through 20-20KHz and saw no attenuation or distortion. Plug into either the 3.5mm stereo headphone jack or the breadboard-friendly pads. We think you'll be pleased with this DAC!

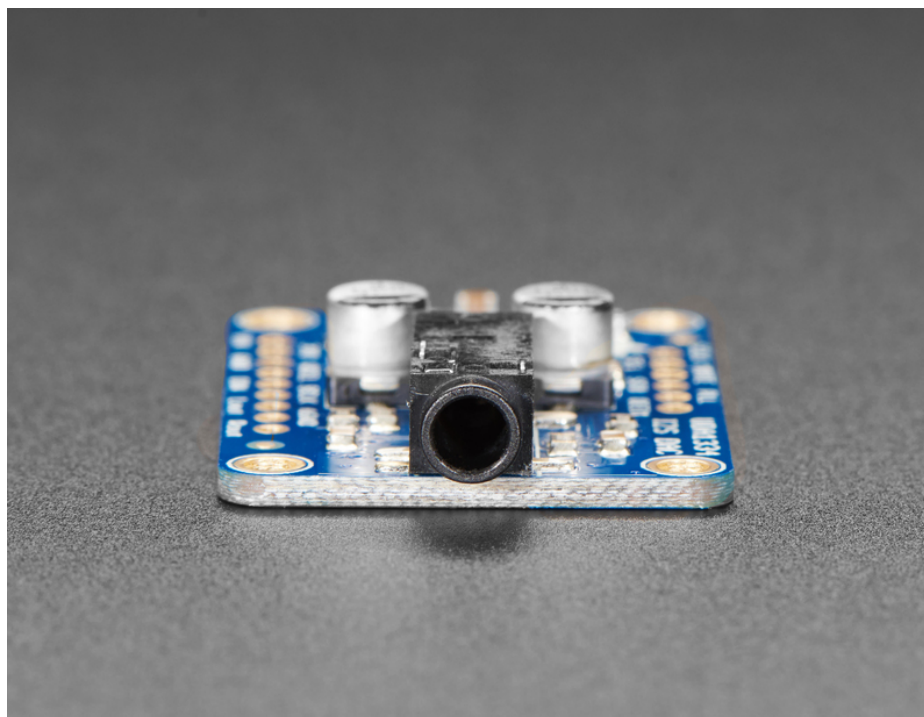

Each order comes with one I2S Stereo DAC breakout and some header you can solder on.

## Pinouts

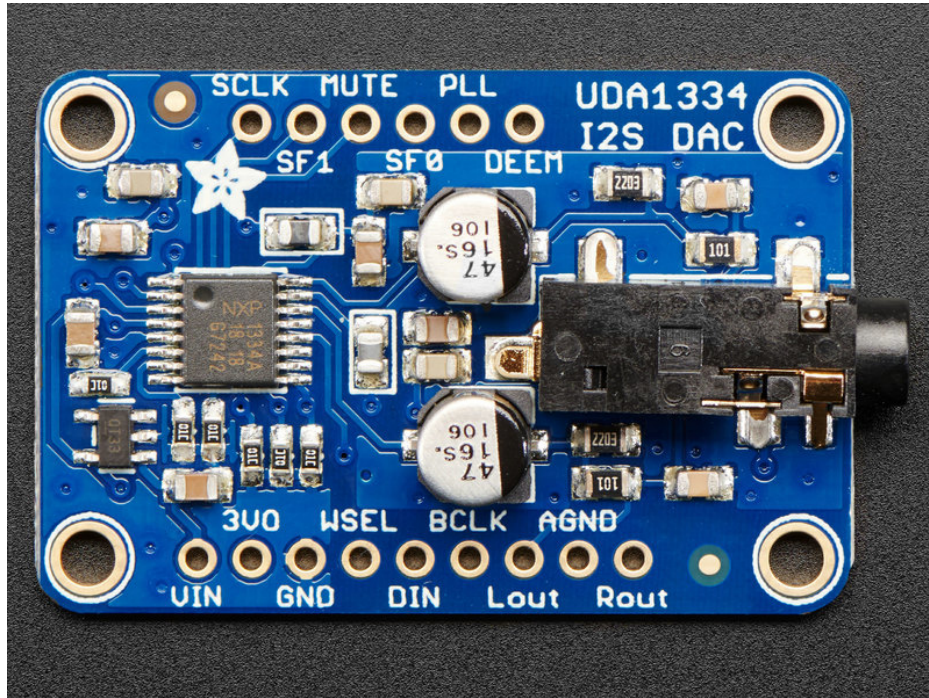

The UDA1334A is an I2S amplifier - it does not use analog inputs, it only has digital audio input support! Don't confuse I2S with I2C, I2S is a sound protocol whereas I2C is for small amounts of data.

## Power Pins

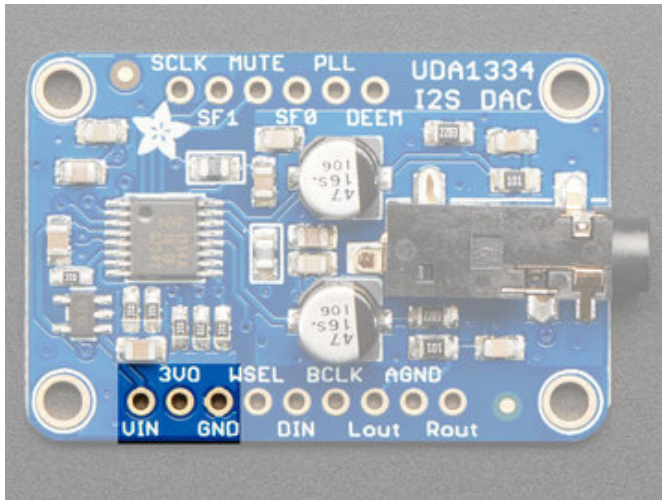

The UDA1334A requires 3.3V power but can take 3-5V level logic on nearly all pins.

You can provide 3-5V power on the **VIN** pin and **GND** and the built in regulator will generate a nice clean 3.3V supplier on **3VOut**.

Use the quietest power supply for Vin, we do filter the power supply, but the quieter the better!

## I2S Pins



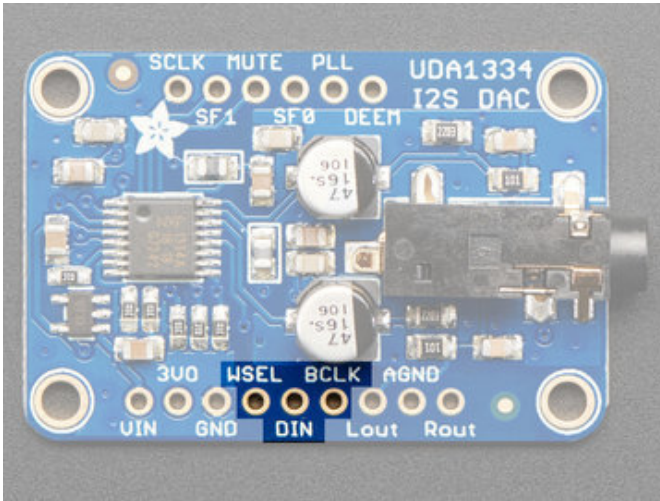

Three pins are used for stereo I2S data in. These pins are required!

These can be 3.3-5V logic

- **WSEL** (Word Select or Left/Right Clock) - this is the pin that tells the DAC when the data is for the left channel and when its for the right channel
- **DIN** (Data In) - This is the pin that has the actual data coming in, both left and right data are sent on this pin, the WSEL pin indicates when left or right is being transmitted
- **BCLK** (Bit Clock) - This is the pin that tells the amplifier when to read data on the data pin.

**MCLK is not required to use this DAC**, if you have an MCLK pin on your audio source, leave it disconnected.

## Audio Outputs

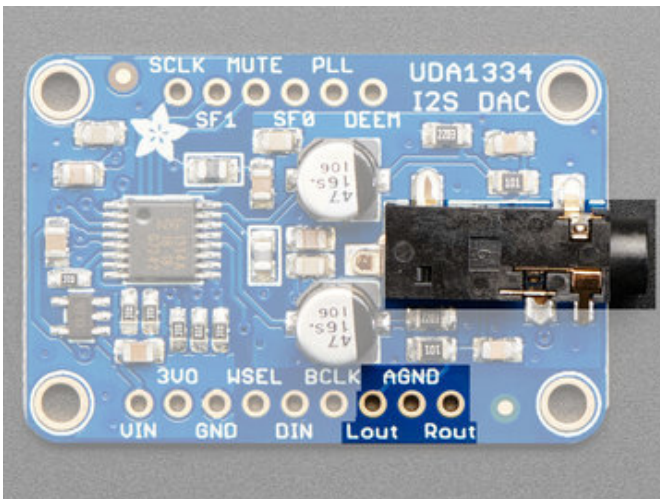

The exciting part! This is where your line level audio comes out. We put big 47µF blocking capacitors on the output so you can connect this to any stereo system. **AGND** is a clean analog ground signal that we recommend using as your analog reference, you'll get a cleaner signal.

Note that this DAC was intended for use with a separate amplifier and is rated for a 3 KΩ load. However, we've found you *can* plug in 32Ω headphones and the output is current-limited so it won't damage the DAC but you will get distortions. (Powered headphones won't have this issue)

## Optional Control Pins

There are some extra configuration pins if you want to use them. They are not required for 99% of usage with an Arduino or Teensy or Raspberry Pi. But you never know! So they are there for you. **PLL** and **SF0** are 3.3V logic only, the other pins are 3-5V safe.

Most of the pins have to do with changing the setup from audio mode to video mode. If you happen to want video-mode, for synchronizing with NTSC/PAL, check the datasheet - we haven't used it for that purpose.

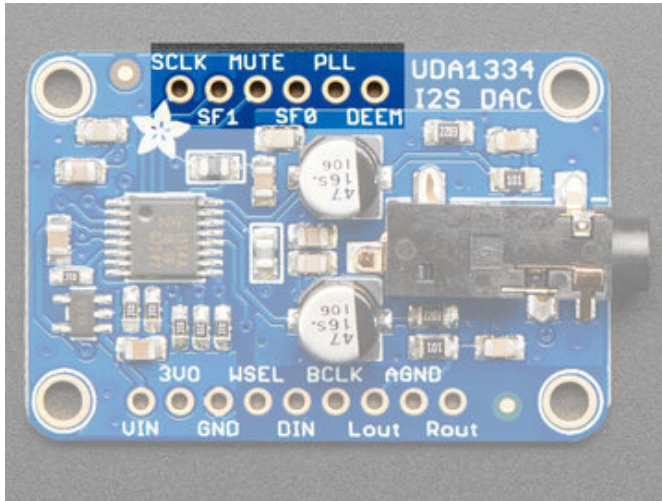

- **SCLK (Sys Clock)** - Optional 27 MHz 'video mode' system clock input - by default we generate the sysclock from the WS clock in 'audio mode' But the UDA can also take an oscillator input on this pin
- **Mute** - Setting this pin High will mute the output
- **De-Emphasis** - In audio mode (which is the default), can be used to add a de-emphasis filter. In video mode, where the system clock is generated from an oscillator, this is the clock output.
- **PLL** - sets the PLL mode, by default pulled low for Audio. Can be pulled high or set to ~1.6V to set PAL or NTSC video frequency

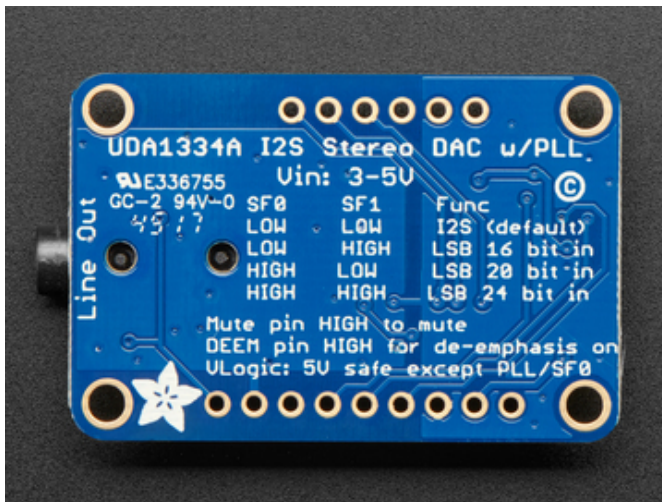

**SF0** and **SF1** are used to set the input data format. By default both are pulled Low for I2S but you can change them around for alternate formats.

See the back of the PCB for a quick reference

## Assembly

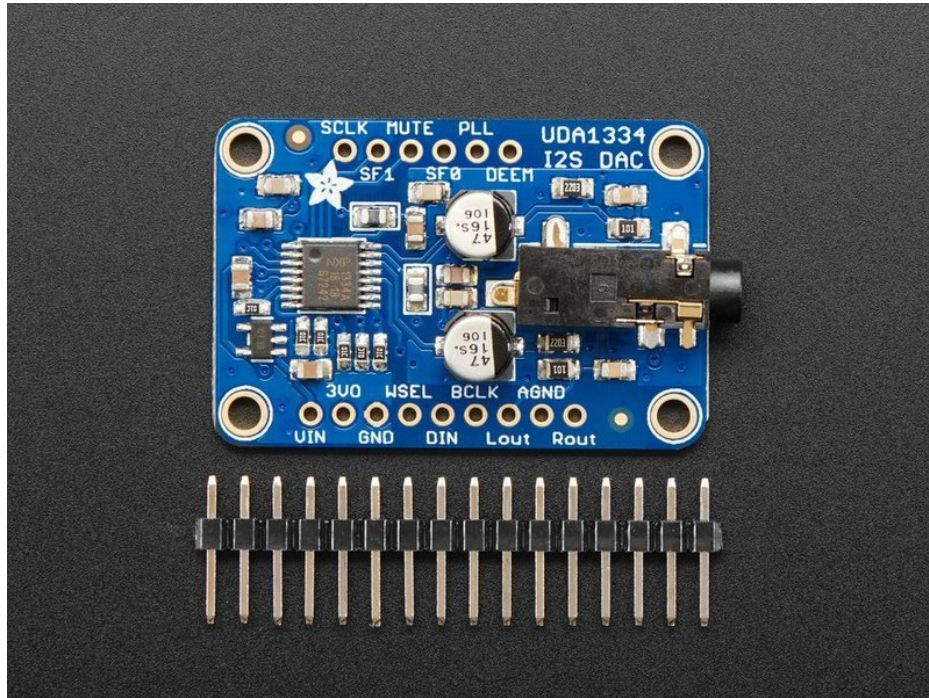

### Installing Standard Headers

The shield comes with 0.1" standard header.

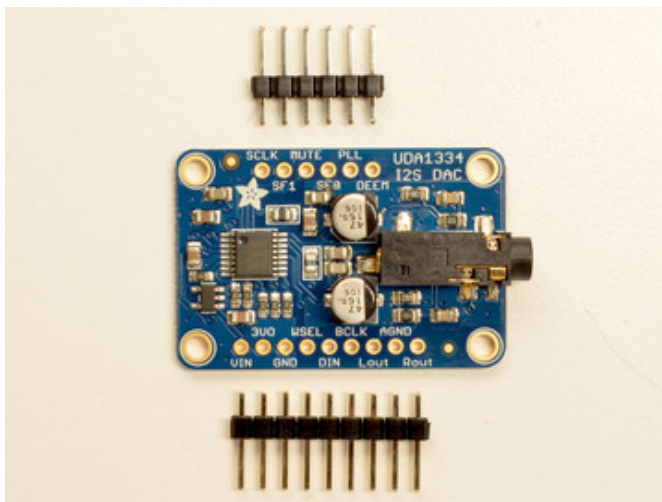

Break apart the 0.1" header into 6 and 9-pin long pieces and slip the short ends into the holes in the board



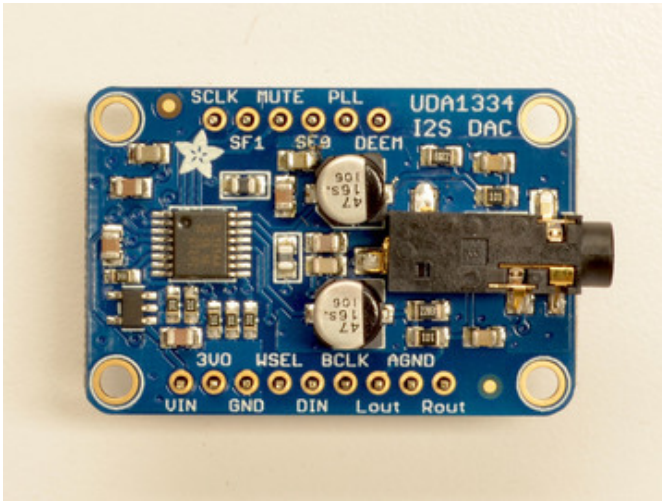

Make sure that all of the short parts of the header are sticking through the two sets of pads on either side of the board

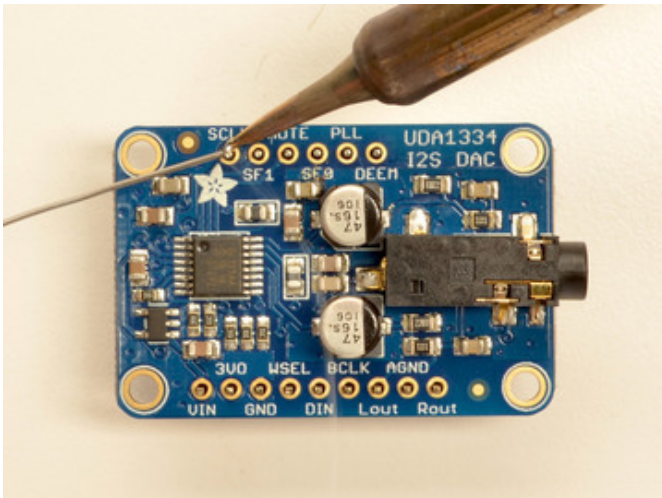

Solder each one of the pins into the board to make a secure connection

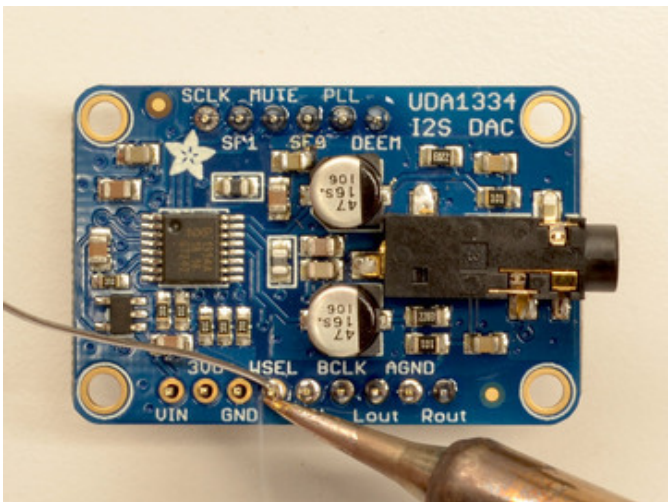
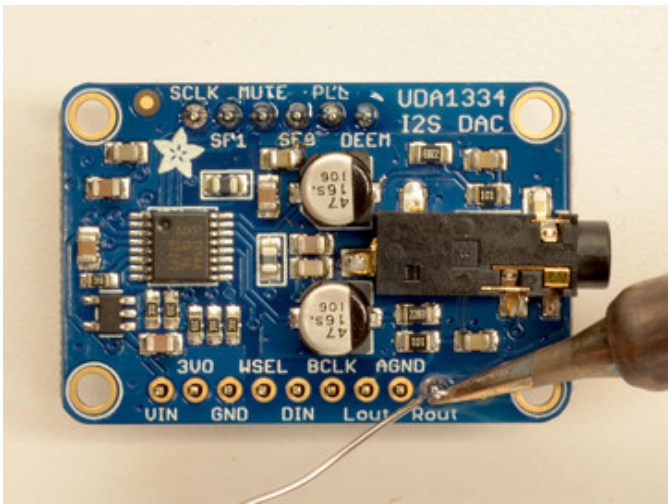
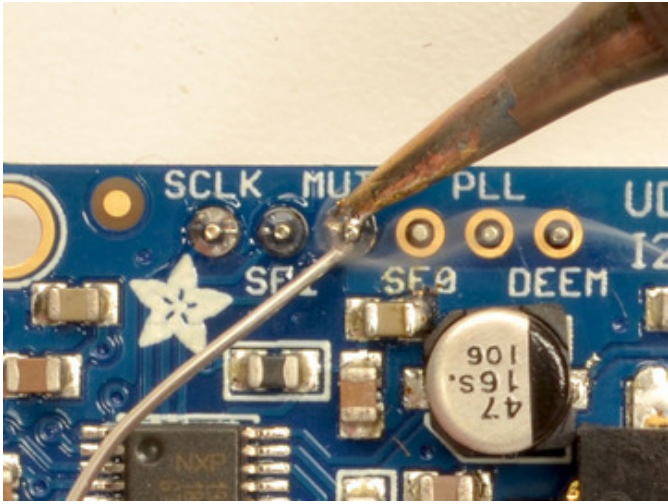

That's it! Move on to next page for wiring information

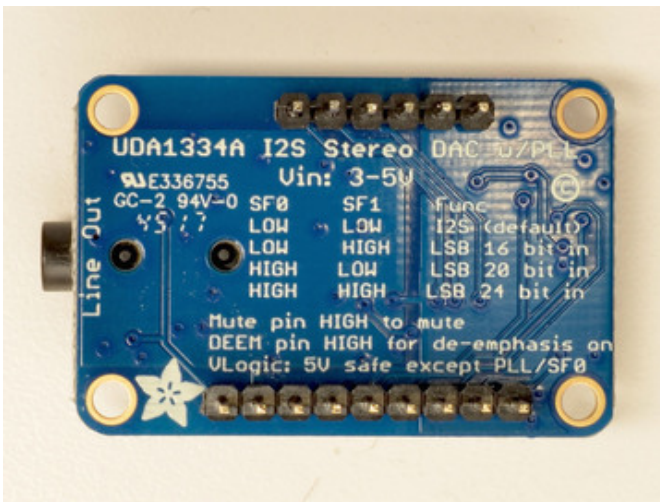
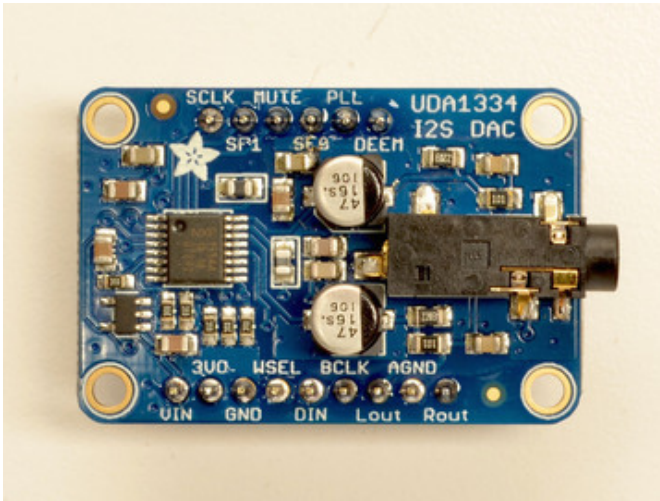



## Raspberry Pi Wiring

if you have a Raspberry Pi and you want higher quality audio than the headphone jack can provide, I2S is a good option! You only use 3 pins, and since its a pure-digital output, there can be less noise and interference.

This board works very well with boards that *don't* have audio like the Pi Zero and is the easiest way to get quality audio out



This technique will work with any Raspberry Pi with the 2x20 connector. Older Pi 1's with a 2x13 connector do not bring out the I2S pins as easily

Connect:

- Amp Vin to Raspberry Pi 3V or 5V
- Amp GND to Raspberry Pi GND
- Amp DIN to Raspberry Pi #21
- Amp BCLK to Raspberry Pi #18
- Amp LRCLK to Raspberry Pi #19

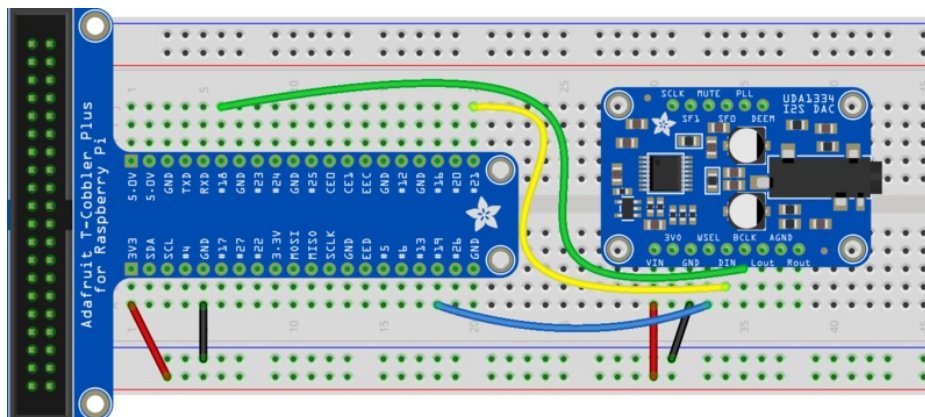

<https://adafru.it/A9T>

<https://adafru.it/A9T>

## Raspberry Pi Setup

At this time, Raspberry Pi linux kernel does not support mono audio out of the I2S interface, you can only play stereo, so any mono audio files may need conversion to stereo!

2017-11-2 Raspbian PIXEL ('full') has broken something in volume control. I2S works, but there's no software volume setup, if you need this, try Raspbian Lite - will try to fix as soon as we figure out why :)

## Fast Install

Luckily its quite easy to install support for I2S DACs on Raspbian.

These instructions are totally cribbed from the PhatDAC instructions at the lovely folks at Pimoron! (<https://adafru.it/nFy>)

Run the following from your Raspberry Pi with Internet connectivity:

```
curl -sS https://raw.githubusercontent.com/adafruit/Raspberry-Pi-Installer-Scripts/master/i2samp.sh | bash
```

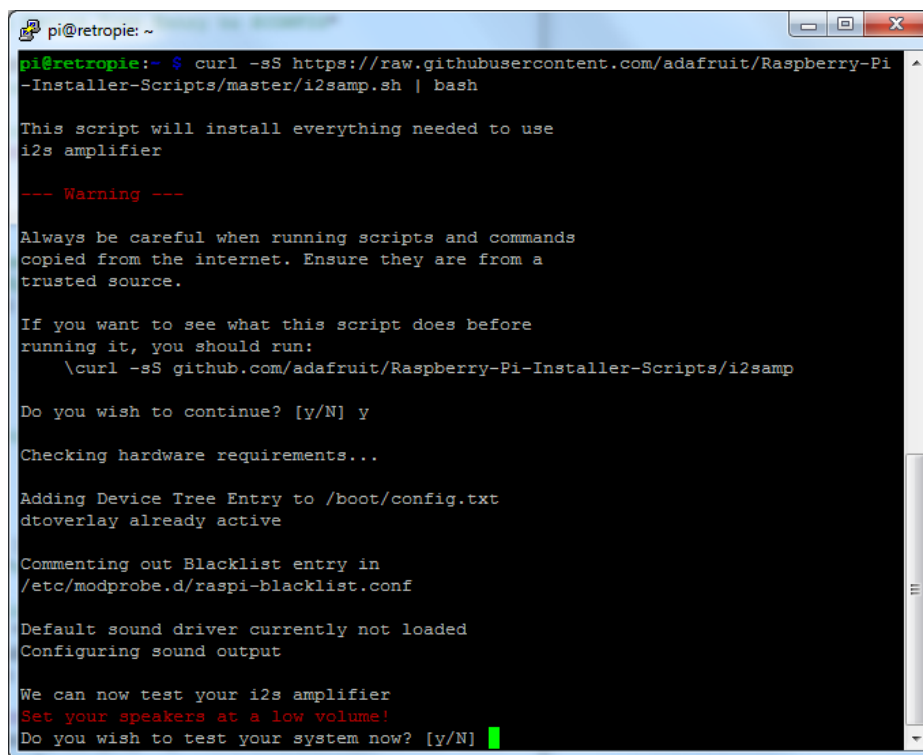

```
pi@retropie: ~  
pi@retropie:~$ curl -sS https://raw.githubusercontent.com/adafruit/Raspberry-Pi-Installer-Scripts/master/i2samp.sh | bash  
  
This script will install everything needed to use  
i2s amplifier  
  
--- Warning ---  
  
Always be careful when running scripts and commands  
copied from the internet. Ensure they are from a  
trusted source.  
  
If you want to see what this script does before  
running it, you should run:  
  \curl -sS github.com/adafruit/Raspberry-Pi-Installer-Scripts/i2samp  
  
Do you wish to continue? [y/N] y  
  
Checking hardware requirements...  
  
Adding Device Tree Entry to /boot/config.txt  
dtoverlay already active  
  
Commenting out Blacklist entry in  
/etc/modprobe.d/raspi-blacklist.conf  
  
Default sound driver currently not loaded  
Configuring sound output  
  
We can now test your i2s amplifier  
Set your speakers at a low volume!  
Do you wish to test your system now? [y/N] █
```

We've added an extra helper systemd script that will play quiet audio when the I2S peripheral isn't in use. This removes popping when playback starts or stops. It uses a tiny amount of CPU time (on a Pi Zero, 5%, on a Pi 2 or 3 its negligible). You don't need this on RetroPie because it never releases the I2S device, but it's great for Raspbian.

```
Installing aplay system unit
Removed /etc/systemd/system/multi-user.target.wants/aplay.service.

You can optionally activate '/dev/zero' playback in
the background at boot. This will remove all
popping/clicking but does use some processor time.

Activate '/dev/zero' playback in background? [RECOMMENDED] [y/N] y
```

You will need to reboot once installed.

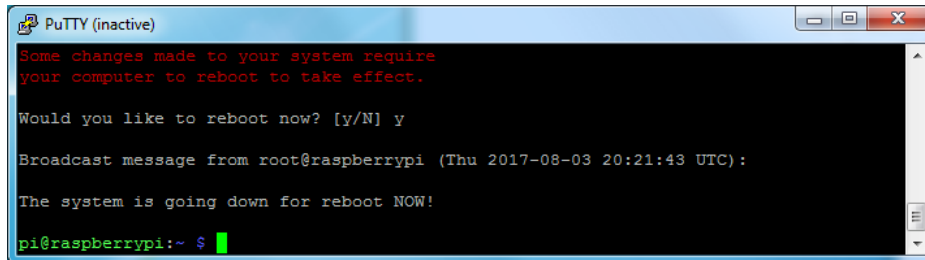

```
PuTTY (inactive)
Some changes made to your system require
your computer to reboot to take effect.

Would you like to reboot now? [y/N] y

Broadcast message from root@raspberrypi (Thu 2017-08-03 20:21:43 UTC):

The system is going down for reboot NOW!

pi@raspberrypi:~ $
```

You must reboot to enable the speaker hardware!

After rebooting, log back in and re-run the script again...It will ask you if you want to test the speaker. Say yes and listen for audio to come out of your speakers...

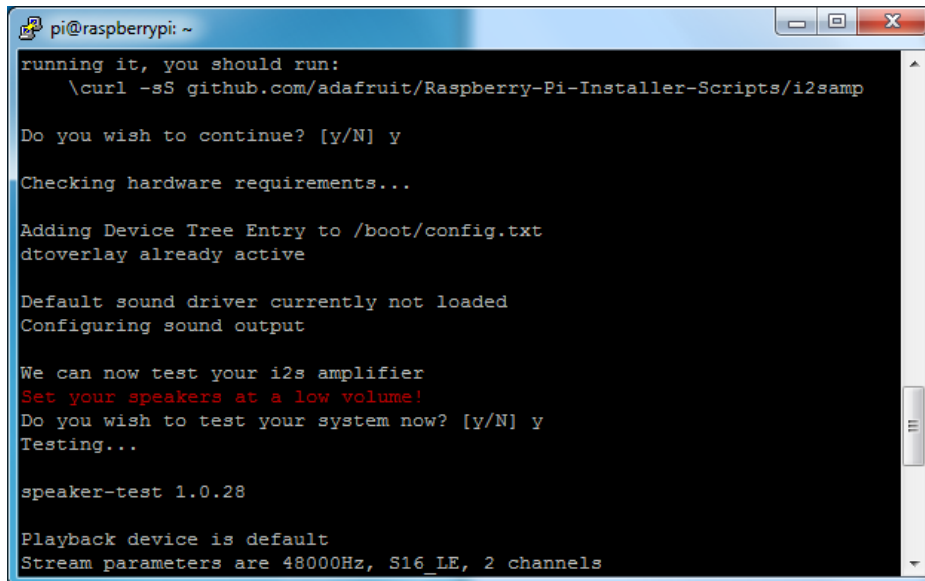

```
pi@raspberrypi: ~
running it, you should run:
  \curl -sS github.com/adafruit/Raspberry-Pi-Installer-Scripts/i2samp

Do you wish to continue? [y/N] y

Checking hardware requirements...

Adding Device Tree Entry to /boot/config.txt
dtoverlay already active

Default sound driver currently not loaded
Configuring sound output

We can now test your i2s amplifier
Set your speakers at a low volume!
Do you wish to test your system now? [y/N] y
Testing...

speaker-test 1.0.28

Playback device is default
Stream parameters are 48000Hz, S16_LE, 2 channels
```

If it sounds really distorted, it could be the volume is too high. However, in order to have volume control appear in Raspbian desktop or RetroPie you must reboot a second time after doing the speaker test, with **sudo reboot**

You must reboot \*twice\* to enable alsamixer volume (really!)

Once rebooted, try running **alsamixer** and use arrow keys to lower the volume, 50% is a good place to start.

If you're still having audio problems, try re-running the script and saying **N** (disable) the **/dev/zero playback service**.



You can then go to the next page on testing and optimizing your setup. Skip the rest of this page on **Detailed Installation** if the script worked for you!

## Detailed Install

---

If, for some reason, you can't just run the script and you want to go through the install by hand - here's all the steps!

Update /etc/modprobe.d (if it exists)

Log into your Pi and get into a serial console (either via a console cable, the TV console, RXVT, or what have you)

Edit the raspi blacklist with

```
sudo nano /etc/modprobe.d/raspi-blacklist.conf
```

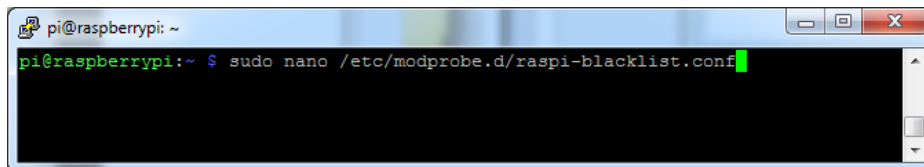

```
pi@raspberrypi: ~  
pi@raspberrypi:~ $ sudo nano /etc/modprobe.d/raspi-blacklist.conf
```

If the file is empty, just skip this step

However, if you see the following lines:

```
blacklist i2c-bcm2708  
blacklist snd-soc-pcm512x  
blacklist snd-soc-wm8804
```

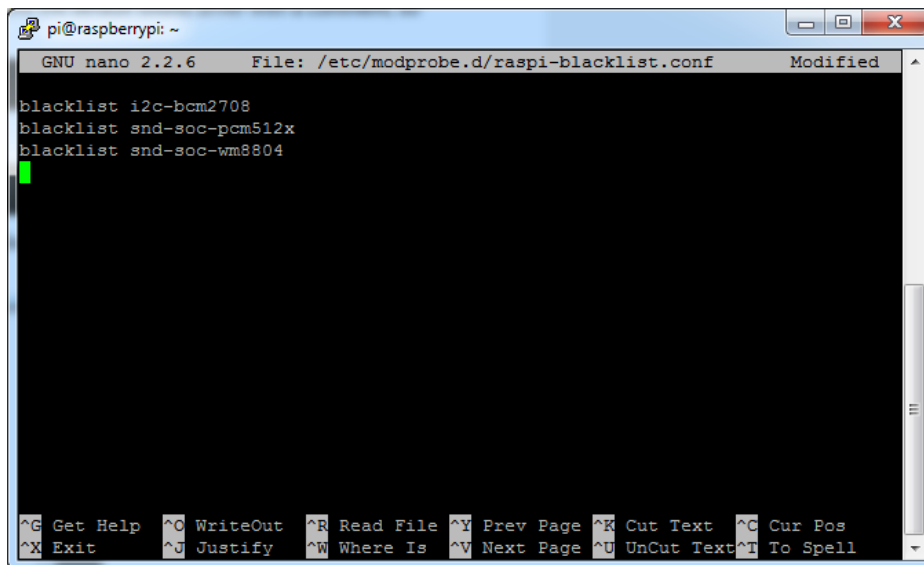

```
pi@raspberrypi: ~  
GNU nano 2.2.6 File: /etc/modprobe.d/raspi-blacklist.conf Modified  
blacklist i2c-bcm2708  
blacklist snd-soc-pcm512x  
blacklist snd-soc-wm8804  
  
^G Get Help ^O WriteOut ^R Read File ^Y Prev Page ^K Cut Text ^C Cur Pos  
^X Exit ^J Justify ^W Where Is ^V Next Page ^U UnCut Text ^I To Spell
```

Update the lines by putting a # before each line

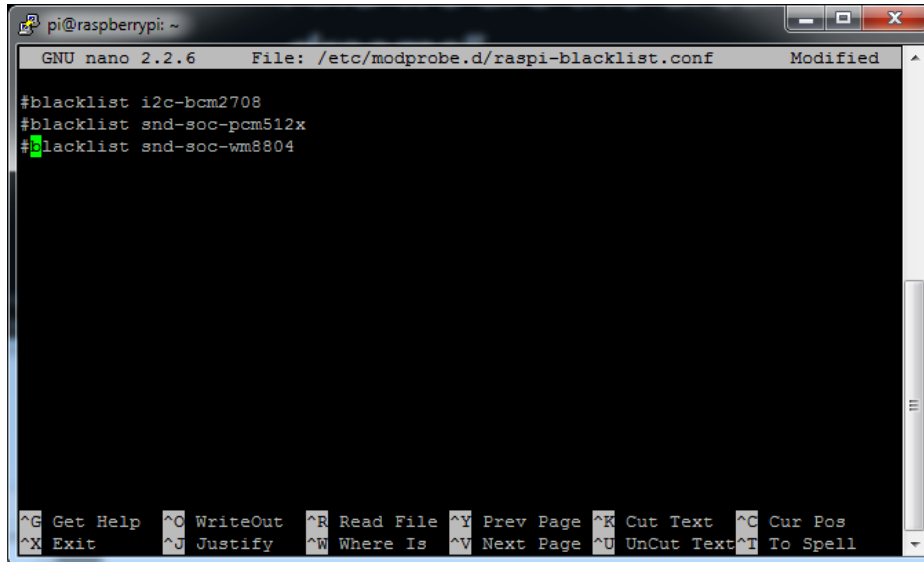

```
pi@raspberrypi: ~
GNU nano 2.2.6 File: /etc/modprobe.d/raspi-blacklist.conf Modified
#blacklist i2c-bcm2708
#blacklist snd-soc-pcm512x
#blacklist snd-soc-wm8804

^G Get Help ^O WriteOut ^R Read File ^Y Prev Page ^K Cut Text ^C Cur Pos
^X Exit ^J Justify ^W Where Is ^V Next Page ^U UnCut Text ^T To Spell
```

Save by typing **Control-X Y <return>**

Disable headphone audio (if it's set)

Edit the raspi modules list with

```
sudo nano /etc/modules
```

If the file is empty, just skip this step

However, if you see the following line:

```
snd_bcm2835
```

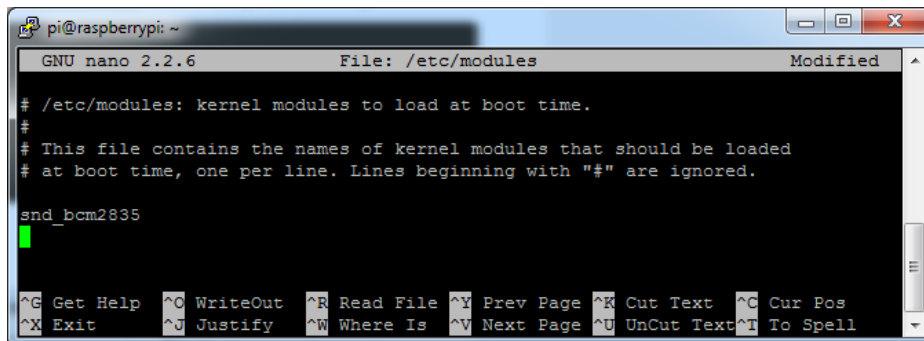

```
pi@raspberrypi: ~
GNU nano 2.2.6 File: /etc/modules Modified
# /etc/modules: kernel modules to load at boot time.
#
# This file contains the names of kernel modules that should be loaded
# at boot time, one per line. Lines beginning with "#" are ignored.
snd_bcm2835

^G Get Help ^O WriteOut ^R Read File ^Y Prev Page ^K Cut Text ^C Cur Pos
^X Exit ^J Justify ^W Where Is ^V Next Page ^U UnCut Text ^T To Spell
```

Put a # in front of it

```
pi@raspberrypi: ~  
GNU nano 2.2.6 File: /etc/modules Modified  
# /etc/modules: kernel modules to load at boot time.  
#  
# This file contains the names of kernel modules that should be loaded  
# at boot time, one per line. Lines beginning with "#" are ignored.  
  
#snd_bcm2835  
  
^G Get Help ^O WriteOut ^R Read File ^Y Prev Page ^K Cut Text ^C Cur Pos  
^X Exit ^J Justify ^W Where Is ^V Next Page ^U UnCut Text ^T To Spell
```

and save with **Control-X Y <return>**

Create asound.conf file

Edit the raspi modules list with

```
sudo nano /etc/asound.conf
```

This file ought to be blank!

```
pi@raspberrypi: ~  
GNU nano 2.2.6 File: /etc/asound.conf  
  
[ New File ]  
  
^G Get Help ^O WriteOut ^R Read File ^Y Prev Page ^K Cut Text ^C Cur Pos  
^X Exit ^J Justify ^W Where Is ^V Next Page ^U UnCut Text ^T To Spell
```

Copy and paste the following text into the file



```
pcm.speakerbonnet {
    type hw card 0
}

pcm.dmixer {
    type dmix
    ipc_key 1024
    ipc_perm 0666
    slave {
        pcm "speakerbonnet"
        period_time 0
        period_size 1024
        buffer_size 8192
        rate 44100
        channels 2
    }
}

ctl.dmixer {
    type hw card 0
}

pcm.softvol {
    type softvol
    slave.pcm "dmixer"
    control.name "PCM"
    control.card 0
}

ctl.softvol {
    type hw card 0
}

pcm.!default {
    type          plug
    slave.pcm     "softvol"
}
```

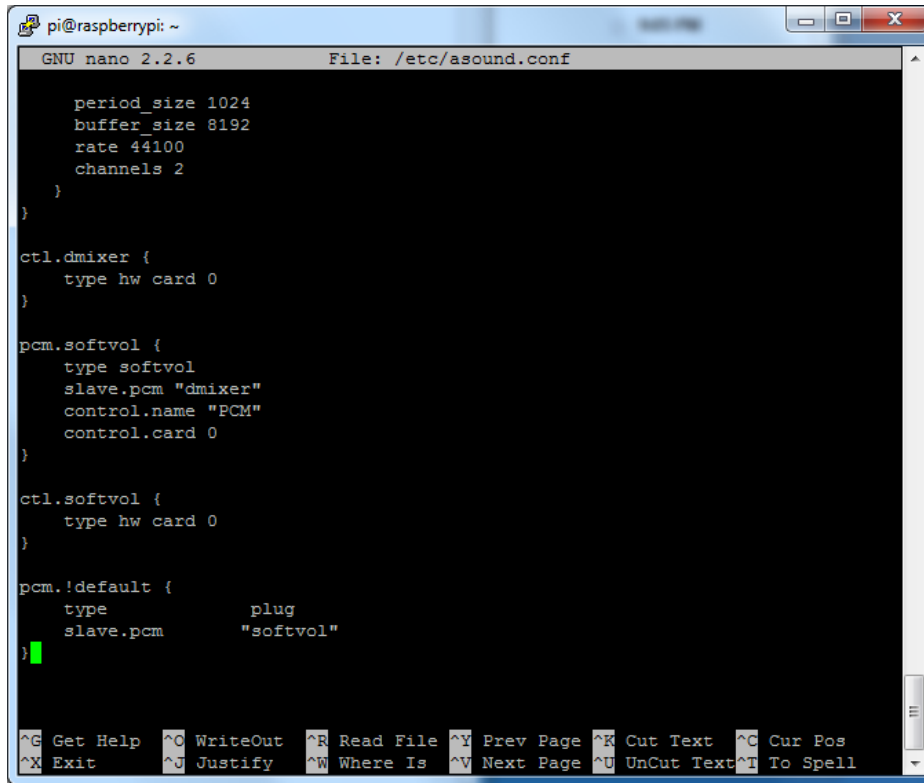

```
pi@raspberrypi: ~
GNU nano 2.2.6 File: /etc/asound.conf

    period_size 1024
    buffer_size 8192
    rate 44100
    channels 2
}
}

ctl.dmixer {
    type hw card 0
}

pcm.softvol {
    type softvol
    slave.pcm "dmixer"
    control.name "PCM"
    control.card 0
}

ctl.softvol {
    type hw card 0
}

pcm.!default {
    type          plug
    slave.pcm     "softvol"
}

^G Get Help  ^O WriteOut  ^R Read File ^Y Prev Page ^K Cut Text   ^C Cur Pos
^X Exit      ^J Justify   ^W Where Is  ^V Next Page ^U UnCut Text ^T To Spell
```

Save the file as usual

## Add Device Tree Overlay

Edit your Pi configuration file with

```
sudo nano /boot/config.txt
```

And scroll down to the bottom. If you see a line that says: `dtparam=audio=on`

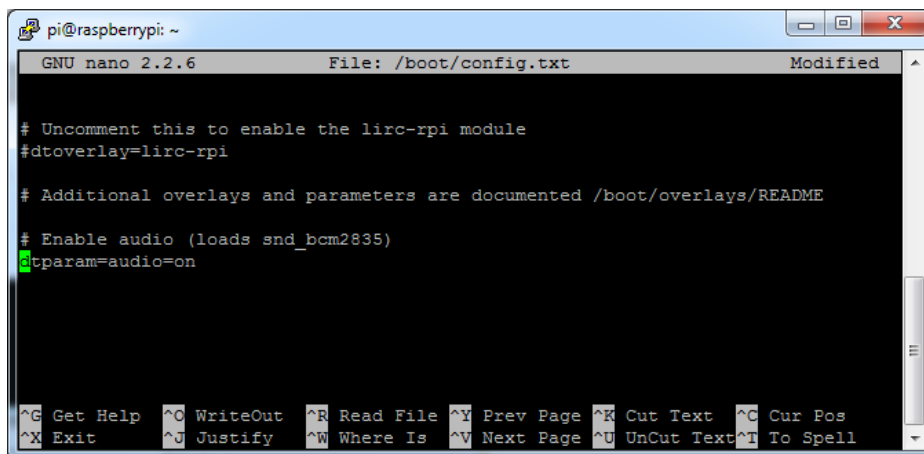

```
pi@raspberrypi: ~
GNU nano 2.2.6 File: /boot/config.txt Modified

# Uncomment this to enable the lirc-rpi module
#dtoverlay=lirc-rpi

# Additional overlays and parameters are documented /boot/overlays/README

# Enable audio (loads snd_bcm2835)
dtparam=audio=on

^G Get Help  ^O WriteOut  ^R Read File ^Y Prev Page ^K Cut Text   ^C Cur Pos
^X Exit      ^J Justify   ^W Where Is  ^V Next Page ^U UnCut Text ^T To Spell
```

Disable it by putting a # in front.

Then add:

```
dtoverlay=hifiberry-dac
dtoverlay=i2s-mmap
```

on the next line. Save the file.

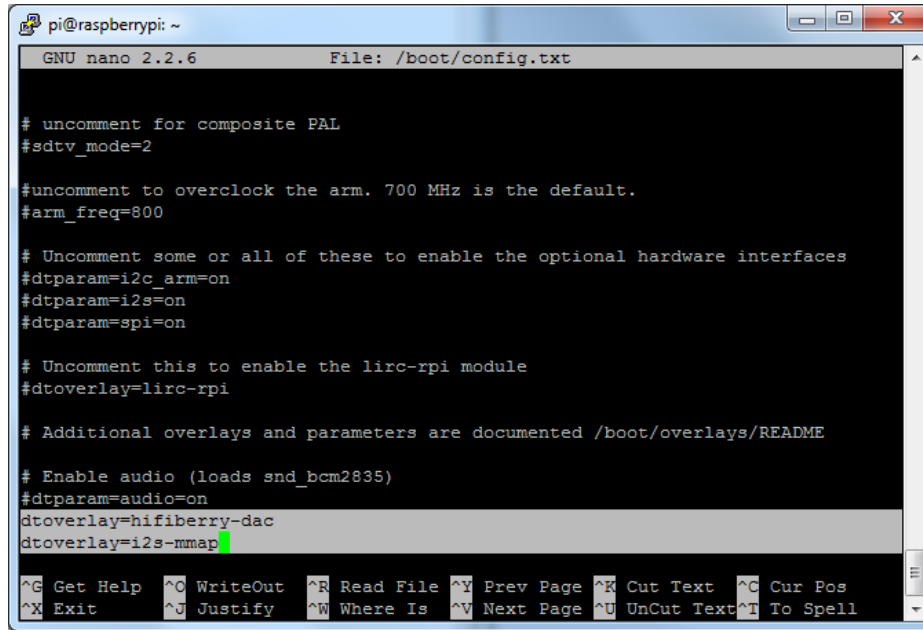

```
pi@raspberrypi: ~
GNU nano 2.2.6 File: /boot/config.txt

# uncomment for composite PAL
#sdtv_mode=2

#uncomment to overclock the arm. 700 MHz is the default.
#arm_freq=800

# Uncomment some or all of these to enable the optional hardware interfaces
#dtparam=i2c_arm=on
#dtparam=i2s=on
#dtparam=spi=on

# Uncomment this to enable the lirc-rpi module
#dtoverlay=lirc-rpi

# Additional overlays and parameters are documented /boot/overlays/README

# Enable audio (loads snd_bcm2835)
#dtparam=audio=on
dtoverlay=hifiberry-dac
dtoverlay=i2s-mmap
```

Reboot your Pi with `sudo reboot`

# Raspberry Pi Test

## Speaker Tests!

---

OK you can use whatever software you like to play audio but if you'd like to test the speaker output, here's some quick commands that will let you verify your amp and speaker are working as they should!

### Simple white noise speaker test

Run `speaker-test -c2` to generate white noise out of the speaker, alternating left and right.

If you have a mono output amplifier, the I2S amp merges left and right channels, so you'll hear continuous white noise

### Simple WAV speaker test

Once you've got something coming out, try to play an audio file with `speaker-test` (for WAV files, not MP3)

```
speaker-test -c2 --test=wav -w /usr/share/sounds/alsa/Front_Center.wav
```

You'll hear audio coming from left and right alternating speakers

### Simple MP3 speaker test

If you want to play a stream of music, you can try

```
sudo apt-get install -y mpg123  
mpg123 http://ice1.somafm.com/u80s-128-mp3
```

If you want to play MP3's on command, check out this tutorial which covers how to set that up (<https://adafru.it/aTD>)

At this time, Jessie Raspberry Pi kernel **does not support mono audio** out of the I2S interface, **you can only play stereo**, so any mono audio files may need conversion to stereo!



omxplayer does not seem use the I2S interface for audio - only HDMI - so you won't be able to use it

## Volume adjustment

---

Many programs like PyGame and Sonic Pi have volume control within the application. For other programs you can set the volume using the command line tool called `alsamixer`. Just type `alsamixer` in and then use the up/down arrows to set the volume. Press Escape once its set



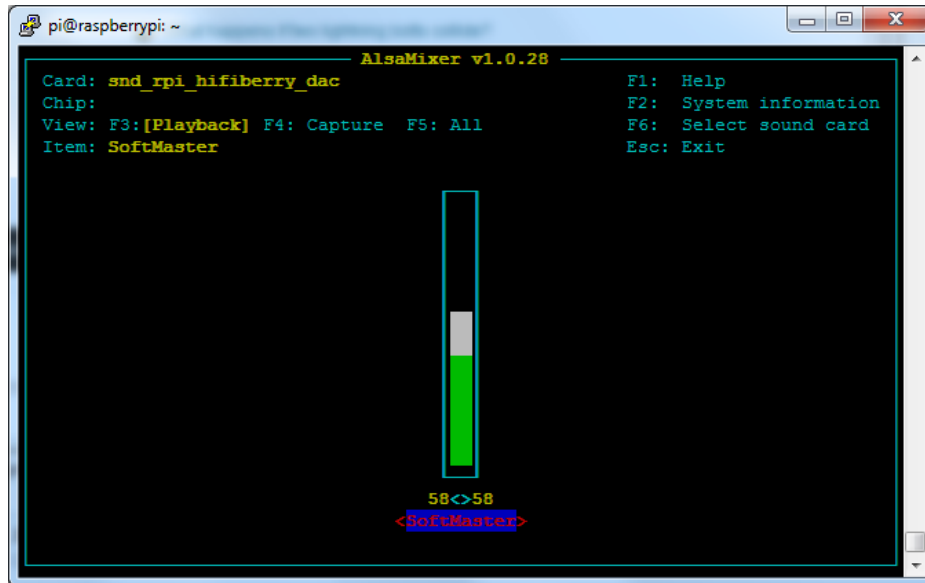

In Raspbian PIXEL you can set the volume using the menu item control. If it has an X through it, try restarting the Pi (you have to restart twice after install to get PIXEL to recognize the volume control)

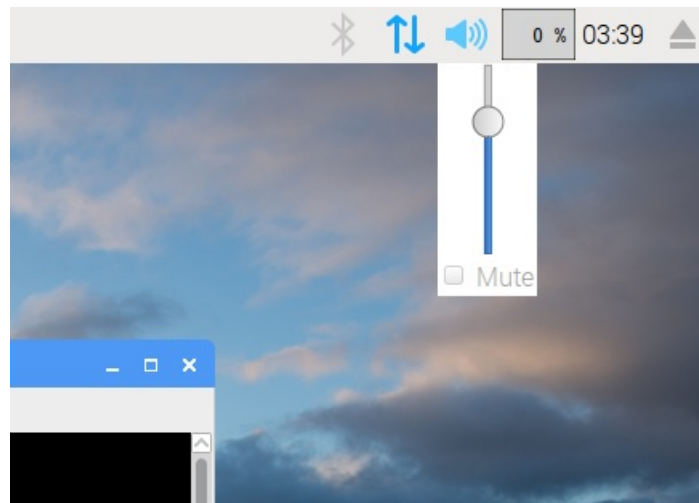

## Pi I2S Tweaks



This page is deprecated, our installer already performs these steps for you, but we'll keep them here for archival use!

### Reducing popping

For people who followed our original installation instructions with the simple alsa config, they may find that the I2S audio pops when playing new audio.

The workaround is to use a software mixer to output a fixed sample rate to the I2S device so the bit clock does not change. I use ALSA so I configured **dmixer** and I no longer have any pops or clicks. Note that the RaspPi I2S driver does not support **dmixer** by default and you must [follow these instructions provided \(https://adafru.it/sHF\)](https://adafru.it/sHF) to add it. Continue on for step-by-step on how to enable it!

#### Step 1

Start by modify `/boot/config.txt` to add `dtoverlay=i2s-mmap`

Run `sudo nano /boot/config.txt` and add the text to the bottom like so:

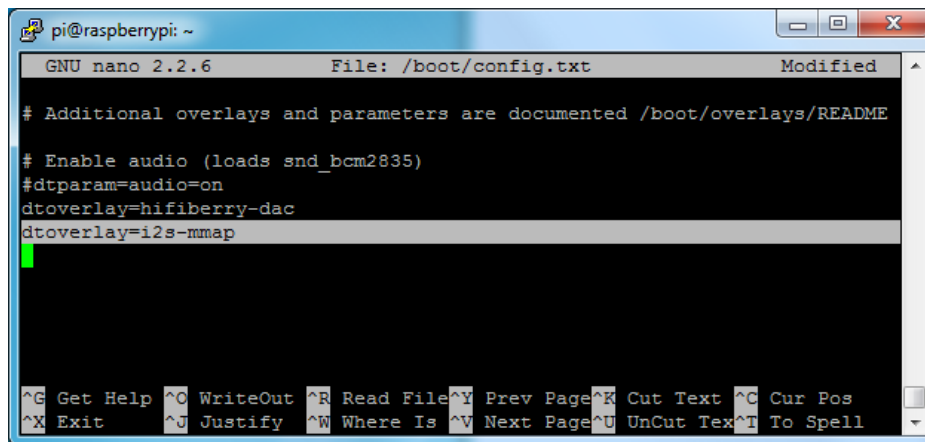

```
pi@raspberrypi: ~
GNU nano 2.2.6 File: /boot/config.txt Modified
# Additional overlays and parameters are documented /boot/overlays/README
# Enable audio (loads snd_bcm2835)
#dtparam=audio=on
dtoverlay=hifiberry-dac
dtoverlay=i2s-mmap
^G Get Help ^O WriteOut ^R Read File ^Y Prev Page ^K Cut Text ^C Cur Pos
^X Exit ^J Justify ^W Where Is ^V Next Page ^U UnCut Text ^T To Spell
```

Save and exit.

Then change `/etc/asound.conf` to:

```

pcm.speakerbonnet {
    type hw card 0
}

pcm.!default {
    type plug
    slave.pcm "dmixer"
}

pcm.dmixer {
    type dmix
    ipc_key 1024
    ipc_perm 0666
    slave {
        pcm "speakerbonnet"
        period_time 0
        period_size 1024
        buffer_size 8192
        rate 44100
        channels 2
    }
}

ctl.dmixer {
    type hw card 0
}

```

By running `sudo nano /etc/asound.conf`

This creates a PCM device called speakerbonnet which is connected to the hardware I2S device. Then we make a new 'dmix' device ( `type dmix` ) called `pcm.dmixer` . We give it a unique Inter Process Communication key ( `ipc_key 1024` ) and permissions that are world-read-writeable ( `ipc_perm 0666` ) The mixer will control the hardware pcm device speakerbonnet (pcm "speakerbonnet") and has a buffer set up so its nice and fast. The communication buffer is set up so there's no delays ( `period_time 0` , `period_size 1024` and `buffer_size 8192` work well). The default mixed rate is 44.1khz stereo ( `rate 44100 channels 2` )

Finally we set up a control interface but it ended up working best to just put in the hardware device here - `ctl.dmixer { type hw card 0 }`

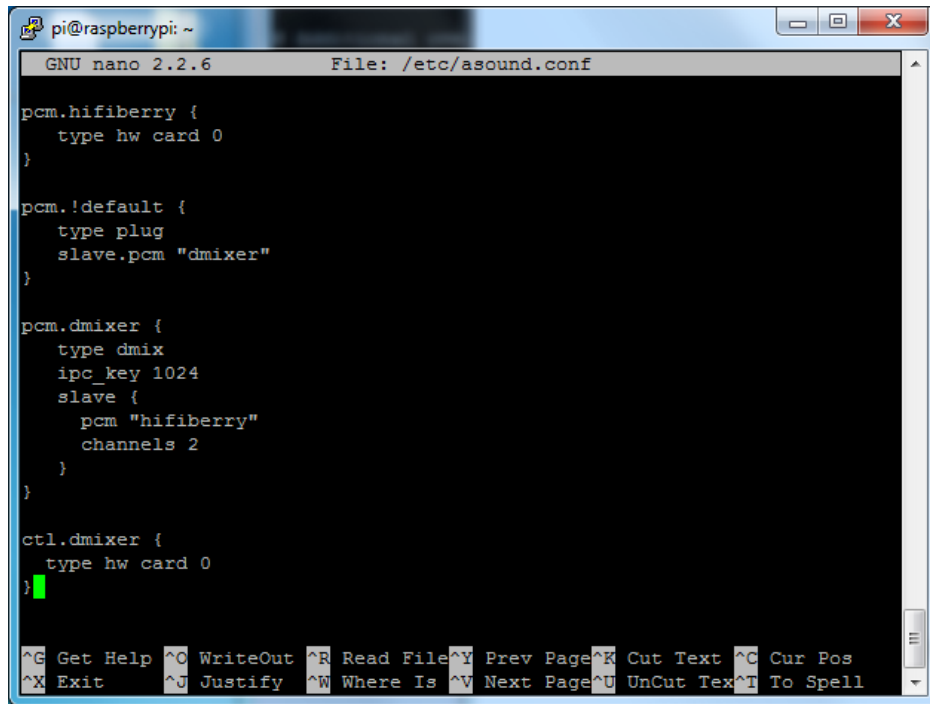

```
pi@raspberrypi: ~
GNU nano 2.2.6 File: /etc/asound.conf

pcm.hifiberry {
  type hw card 0
}

pcm.!default {
  type plug
  slave.pcm "dmixer"
}

pcm.dmixer {
  type dmix
  ipc_key 1024
  slave {
    pcm "hifiberry"
    channels 2
  }
}

ctl.dmixer {
  type hw card 0
}

^G Get Help ^O WriteOut ^R Read File ^Y Prev Page ^K Cut Text ^C Cur Pos
^X Exit ^J Justify ^W Where Is ^V Next Page ^U UnCut Text ^T To Spell
```

Save and exit. Then reboot the Pi to enable the mixer. Also, while it will *greatly* reduce popping, you still may get one once in a while - especially when first playing audio!

## Add software volume control

The basic I2S chipset used here does not have software control built in. So we have to 'trick' the Pi into creating a software volume control. [Luckily, its not hard once you know how to do it \(https://adafruit.it/ydQ\)](https://adafruit.it/ydQ).

Create a new audio config file in `~/asoundrc` with `nano ~/.asoundrc` and inside put the following text:



```

pcm.speakerbonnet {
    type hw card 0
}

pcm.dmixer {
    type dmix
    ipc_key 1024
    ipc_perm 0666
    slave {
        pcm "speakerbonnet"
        period_time 0
        period_size 1024
        buffer_size 8192
        rate 44100
        channels 2
    }
}

ctl.dmixer {
    type hw card 0
}

pcm.softvol {
    type softvol
    slave.pcm "dmixer"
    control.name "PCM"
    control.card 0
}

ctl.softvol {
    type hw card 0
}

pcm.!default {
    type          plug
    slave.pcm     "softvol"
}

```

 This assumes you set up the dmixer for no-popping above!



## Play Audio with PyGame

You can use **mpg123** for basic testing but it's a little clumsy for use where you want to dynamically change the volume or have an interactive program. For more powerful audio playback we suggest using PyGame to playback a variety of audio formats (MP3 included!)

### Install PyGame

---

Start by installing pygame support, you'll need to open up a console on your Pi with network access and run:

```
sudo apt-get install python-pygame
```

Next, download this pygame example zip to your Pi

```
https://adafru.it/wbp
```

```
https://adafru.it/wbp
```

On the command line, run

```
wget https://cdn-learn.adafruit.com/assets/assets/000/041/506/original/pygame_example.zip (https://adafru.it/wbq)
```

```
unzip pygame_example.zip (https://adafru.it/wbq)
```

### Run Demo

---

Inside the zip is an example called **pygameMP3.py**

This example will playback all MP3's within the script's folder. To demonstrate that you can also adjust the volume within pygame, the second argument is the volume for playback. Specify a volume to playback with a command line argument between 0.0 and 1.0

For example here is how to play at 75% volume:

```
python pygameMP3.py 0.75
```

Here's the code if you have your own mp3s!

```
''' pg_midi_sound101.py
play midi music files (also mp3 files) using pygame
tested with Python273/331 and pygame192 by vegaseat
'''

#code modified by James DeVito from here: https://www.daniweb.com/programming/software-
development/code/454835/let-pygame-play-your-midi-or-mp3-files

#!/usr/bin/python

import sys
import pygame as pg
```

```

import os
import time

def play_music(music_file):
    '''
    stream music with mixer.music module in blocking manner
    this will stream the sound from disk while playing
    '''
    clock = pg.time.Clock()
    try:
        pg.mixer.music.load(music_file)
        print("Music file {} loaded!".format(music_file))
    except pygame.error:
        print("File {} not found! {}".format(music_file, pg.get_error()))
        return

    pg.mixer.music.play()

    # If you want to fade in the audio...
    # for x in range(0,100):
    #     pg.mixer.music.set_volume(float(x)/100.0)
    #     time.sleep(.0075)
    # # check if playback has finished
    while pg.mixer.music.get_busy():
        clock.tick(30)

freq = 44100 # audio CD quality
bitsize = -16 # unsigned 16 bit
channels = 2 # 1 is mono, 2 is stereo
buffer = 2048 # number of samples (experiment to get right sound)
pg.mixer.init(freq, bitsize, channels, buffer)

if len(sys.argv) > 1:
    try:
        user_volume = float(sys.argv[1])
    except ValueError:
        print "Volume argument invalid. Please use a float (0.0 - 1.0)"
        pg.mixer.music.fadeout(1000)
        pg.mixer.music.stop()
        raise SystemExit

    print("Playing at volume: " + str(user_volume)+ "\n")
    pg.mixer.music.set_volume(user_volume)
    mp3s = []
    for file in os.listdir("."):
        if file.endswith(".mp3"):
            mp3s.append(file)

    print mp3s

    for x in mp3s:
        try:
            play_music(x)
            time.sleep(.25)
        except KeyboardInterrupt:
            # if user hits Ctrl/C then exit

```



```
    # If user hits ctrl/C then exit
    # (works only in console mode)
    pg.mixer.music.fadeout(1000)
    pg.mixer.music.stop()
    raise SystemExit
else:
    print("Please specify volume as a float! (0.0 - 1.0)")
```

## Arduino Wiring & Test

The classic ATmega328P-based Arduino's like the UNO and Metro 328 don't have I2S interfaces, so you *can't* use this breakout with them

But the newer ATSAMD21-based boards like the Zero, Metro M0, Feather M0 can! (Note, Gemma M0 & Trinket M0 do not have I2S pins available). And so can the even newer ATSAMD51-based boards like the Metro M4 and Feather M4.

To use I2S with M0 or M4 boards, you'll need to install the [Adafruit Zero I2S library \(https://adafru.it/DHD\)](https://adafru.it/DHD). It is available through the Library Manager. You can search for (see below) and then just click the install button.

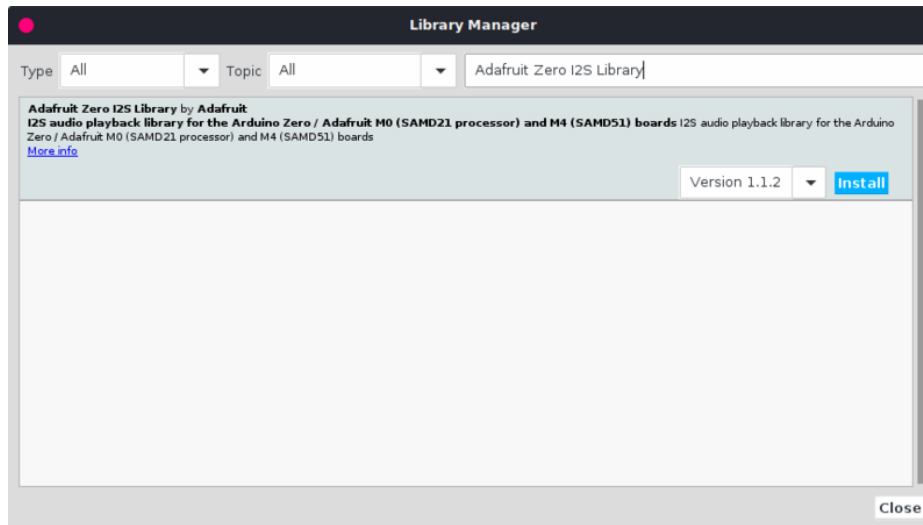

### Wiring

Wiring connections are the same as those used for CircuitPython. So go to the [CircuitPython Wiring & Test](#) page to see how to wire the breakout for your specific board.

### Basic Test

To test things out, try running the demo below. It comes with the library installation, so you can find it by going to:

**File -> Examples -> Adafruit Zero I2S Library -> basic**

Be sure to change this line:

```
Adafruit_ZeroI2S i2s(0, 1, 9, 2);
```

to match the pins used for your setup. If you've wired as shown in this guide, then you can try using the default pins by changing that line to this:

```
Adafruit_ZeroI2S i2s;
```

```

#include <Arduino.h>

#include <Adafruit_ZeroI2S.h>
#include <math.h>

/* max volume for 32 bit data */
#define VOLUME ( (1UL << 31) - 1)

/* create a buffer for both the left and right channel data */
#define BUFSIZE 128
int left[BUFSIZE];
int right[BUFSIZE];

Adafruit_ZeroI2S i2s(0, 1, 9, 2);

void setup()
{
  for(int i=0; i<BUFSIZE; i++){
    /* create a sine wave on the left channel */
    left[i] = sin( (2*PI / (BUFSIZE) ) * i ) * VOLUME;

    /* create a cosine wave on the right channel */
    right[i] = cos( (2*PI / (BUFSIZE) ) * i ) * VOLUME;
  }

  /* begin I2S on the default pins. 24 bit depth at
   * 44100 samples per second
   */
  i2s.begin(I2S_32_BIT, 44100);
  i2s.enableTx();
}

void loop()
{
  /* write the output buffers
   * note that i2s.write() will block until both channels are written.
   */
  for(int i=0; i<BUFSIZE; i++){
    i2s.write(left[i], right[i]);
  }
}

```

## DMA Test

The basic test above created the output directly by using the `i2s.write()` function in a loop. Another approach is to use DMA to generate the output. With this approach, you do some initial setup to configure the DMA engine for playback. It can then take care of generating the output in the background allowing you to do other things in your code.

To take this approach, you will need to install the [Zero DMA library \(https://adafru.it/lnb\)](https://adafru.it/lnb). You can do that through the Library Manager:

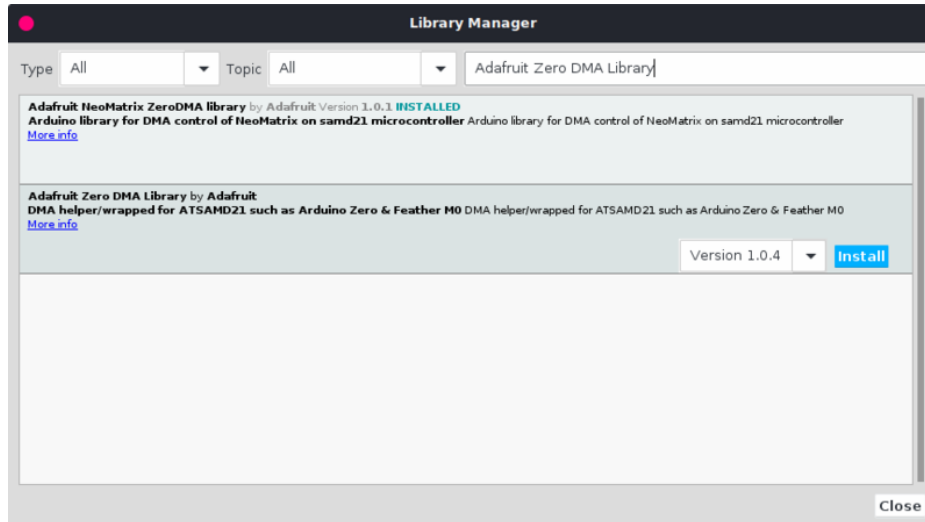

And then you can use the DMA example found in the Zero I2S library:

File -> Examples -> Adafruit Zero I2S Library -> dma

```

#include <Adafruit_ZeroI2S.h>
#include <Adafruit_ZeroDMA.h>
#include "utility/dma.h"
#include <math.h>

/* max volume for 32 bit data */
#define VOLUME ( 1UL << 31) - 1

/* create a buffer for both the left and right channel data */
#define BUFSIZE 256
int data[BUFSIZE];

Adafruit_ZeroDMA myDMA;
ZeroDMAstatus stat; // DMA status codes returned by some functions

Adafruit_ZeroI2S i2s;

void dma_callback(Adafruit_ZeroDMA *dma) {
  /* we don't need to do anything here */
}

void setup()
{
  Serial.begin(115200);
  //while(!Serial); // Wait for Serial monitor before continuing

  Serial.println("I2S output via DMA");

  int *ptr = data;

  /*the I2S module will be expecting data interleaved LRLR*/
  for(int i=0; i<BUFSIZE/2; i++){
    /* create a sine wave on the left channel */
    *ptr++ = sin( (2*PI / (BUFSIZE/2) ) * i) * VOLUME;

    /* create a cosine wave on the right channel */
    *ptr++ = cos( (2*PI / (BUFSIZE/2) ) * i) * VOLUME;
  }
}

```

```

    *ptr++ = cos( (2*PI / (BUFSIZE/2) ) * 1) * VOLUME;
}

Serial.println("Configuring DMA trigger");
myDMA.setTrigger(I2S_DMAC_ID_TX_0);
myDMA.setAction(DMA_TRIGGER_ACTON_BEAT);

Serial.print("Allocating DMA channel...");
stat = myDMA.allocate();
myDMA.printStatus(stat);

Serial.println("Setting up transfer");
myDMA.addDescriptor(
    data, // move data from here
#if defined(__SAM51__)
    (void *)&I2S->TXDATA.reg, // to here (M4)
#else
    (void *)&I2S->DATA[0].reg, // to here (M0+)
#endif
    BUFSIZE, // this many...
    DMA_BEAT_SIZE_WORD, // bytes/hword/words
    true, // increment source addr?
    false);
myDMA.loop(true);
Serial.println("Adding callback");
myDMA.setCallback(dma_callback);

/* begin I2S on the default pins. 24 bit depth at
 * 44100 samples per second
 */
i2s.begin(I2S_32_BIT, 44100);
i2s.enableTx();

stat = myDMA.startJob();
}

void loop()
{
    Serial.println("do other things here while your DMA runs in the background.");
    delay(2000);
}

```



## CircuitPython Wiring & Test

CircuitPython 3.0 and higher has I2S built in which means you can use this breakout super easily with the supported M0 and M4 Express CircuitPython boards! Supported boards are Feather M0 Express, Feather M4 Express, Metro M0 Express, Metro M4 Express, and ItsyBitsy M0 Express.

Note that Trinket M0, Gemma M0 and ItsyBitsy M4 do not support I2S (the last one is not a typo!)

The M0 boards have multiple I2S pin combinations available. We're going to demonstrate a single pin combination for each board.

### Wiring

The following wiring diagrams show how to connect the UDA1334 breakout to your CircuitPython board. You'll be using voltage in, ground, bit clock, word select and data pins.

- **VIN** is the **red** wire.
- **GND** is the **black** wire.
- **BCLK** is the **blue** wire.
- **WSEL** is the **yellow** wire.
- **DIN** is the **green** wire.

For Feather M0 Express, ItsyBitsy M0 Express and Metro M0 Express:

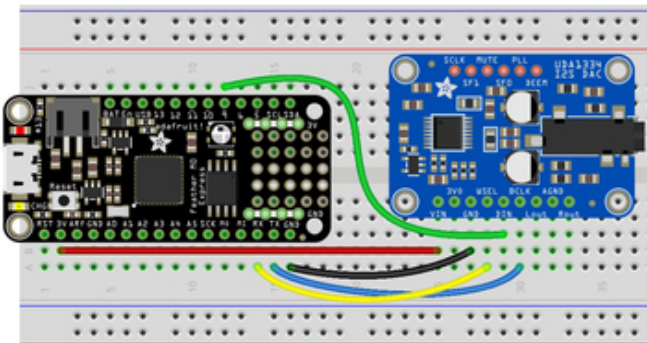

- Connect **VIN** on the breakout to **3V/3.3** on the board.
- Connect **GND** on the breakout to **G/GND** on the board.
- Connect **BCLK** on the breakout to **D1/TX** on the board.
- Connect **WSEL** on the breakout to **D0/RX** on the board.
- Connect **DIN** on the breakout to **D9** on the board.

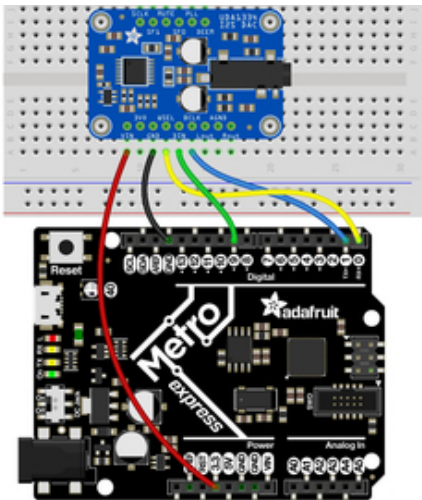
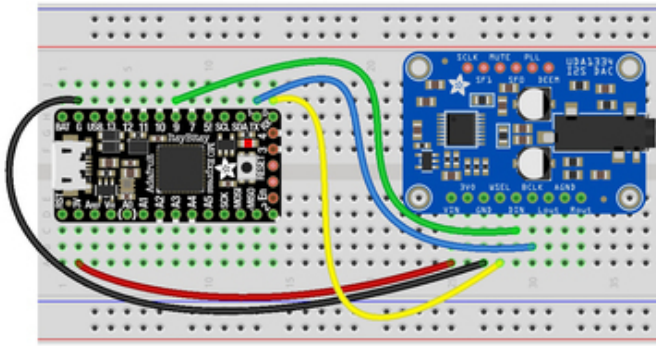

**For Feather M4 Express:**

- Connect VIN on the breakout to 3V on the board.
- Connect GND on the breakout to Gnd on the board.
- Connect BCLK on the breakout to TX on the board.
- Connect WSEL on the breakout to D10 on the board.
- Connect DIN on the breakout to D11 on the board.

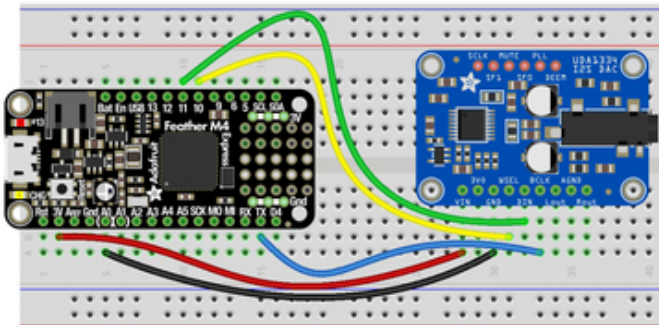

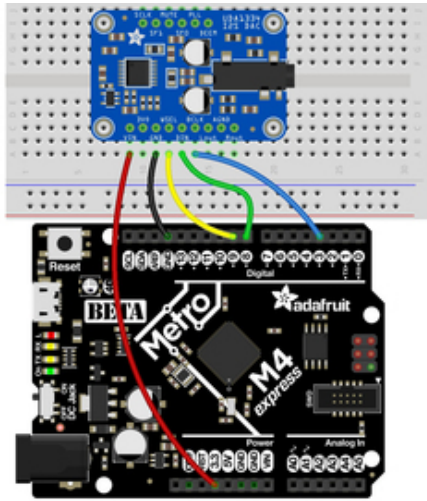

#### For Metro M4 Express:

- Connect **VIN** on the breakout to **3.3** on the board.
- Connect **GND** on the breakout to **GND** on the board.
- Connect **BCLK** on the breakout to **D3** on the board.
- Connect **WSEL** on the breakout to **D9** on the board.
- Connect **DIN** on the breakout to **D8** on the board.

## Code Examples

We have two CircuitPython code examples. The first plays a generated tone through the audio jack on the breakout. The second plays a wave file. Let's take a look!



The default volume of the audio in the following code is very high. Do put on plugged in headphones before first running the code to check the volume.

## Tone Generation

The first example generates one period of a sine wave and then loops it to generate a tone. You can change the volume and the Hz of the tone by changing the associated variables. Inside the loop, we play the tone for one second and stop it for one second.

```

import time
import array
import math
import audioio
import board
import audiobusio

tone_volume = 0.1 # Increase this to increase the volume of the tone.
frequency = 440 # Set this to the Hz of the tone you want to generate.
length = 8000 // frequency
sine_wave = array.array("h", [0] * length)
for i in range(length):
    sine_wave[i] = int((math.sin(math.pi * 2 * i / length)) * tone_volume * (2 ** 15 - 1))

# For Feather M0 Express, ItsyBitsy M0 Express, Metro M0 Express
audio = audiobusio.I2SOut(board.D1, board.D0, board.D9)
# For Feather M4 Express
# audio = audiobusio.I2SOut(board.D1, board.D10, board.D11)
# For Metro M4 Express
# audio = audiobusio.I2SOut(board.D3, board.D9, board.D8)
sine_wave_sample = audioio.RawSample(sine_wave)

while True:
    audio.play(sine_wave_sample, loop=True)
    time.sleep(1)
    audio.stop()
    time.sleep(1)

```

For **Feather M0 Express**, **ItsyBitsy M0 Express** and **Metro M0 Express**, no changes are needed for the code to work.

For **Feather M4 Express**, comment out `audio = audiobusio.I2SOut(board.D1, board.D0, board.D9)` and uncomment `# audio = audiobusio.I2SOut(board.D1, board.D10, board.D11)`.

For **Metro M4 Express**, comment out `audio = audiobusio.I2SOut(board.D1, board.D0, board.D9)` and uncomment `# audio = audiobusio.I2SOut(board.D3, board.D3, board.D8)`.

Now you'll hear one second of a 440Hz tone, and one second of silence. Remember, listen for it without headphones on your ears first as the volume is quite high.

You can try changing the Hz of the tone to produce different tones. Try changing the number of seconds in `time.sleep()` to produce longer or shorter tones.

## Wave File

The second example plays a wave file. We open the file in a readable format. Then inside the loop, we play the file and tell the code to continue playing the file until it's completed. You can use any [supported wave file](https://adafruit.it/BRJ) (<https://adafruit.it/BRJ>). We've included the wave file used in the code.

<https://adafruit.it/BTM>

<https://adafruit.it/BTM>

```

import audioio
import board
import audiobusio

wave_file = open("StreetChicken.wav", "rb")
wave = audioio.WaveFile(wave_file)

# For Feather M0 Express, ItsyBitsy M0 Express, Metro M0 Express
audio = audiobusio.I2SOut(board.D1, board.D0, board.D9)
# For Feather M4 Express
# audio = audiobusio.I2SOut(board.D1, board.D10, board.D11)
# For Metro M4 Express
# audio = audiobusio.I2SOut(board.D3, board.D9, board.D8)

while True:
    audio.play(wave)
    while audio.playing:
        pass

```

The object setup in the code is the same as above.

For **Feather M0 Express**, **ItsyBitsy M0 Express** and **Metro M0 Express**, no changes are needed for the code to work.

For **Feather M4 Express**, comment out `audio = audiobusio.I2SOut(board.D1, board.D0, board.D9)` and uncomment `# audio = audiobusio.I2SOut(board.D1, board.D10, board.D11)`.

For **Metro M4 Express**, comment out `audio = audiobusio.I2SOut(board.D1, board.D0, board.D9)` and uncomment `# audio = audiobusio.I2SOut(board.D3, board.D3, board.D8)`.

Now you'll hear the wave file play through and loop. Remember, listen for it without headphones on your ears first as the volume is quite high.

There's plenty you can do with this example. Try playing a different wave file, or, instead of including `while audio.playing: pass`, include a `time.sleep()` to have it play for a specified number of seconds. Check out the [Audio Out page in the CircuitPython Essentials guide \(https://adafru.it/BRj\)](https://adafru.it/BRj) for `pause` and `resume` features.



For more information about I2SOut, check out <https://circuitpython.readthedocs.io/en/latest/shared-bindings/audiobusio/I2SOut.html>

## Where's my I2S?

We mentioned earlier that the supported M0 boards have multiple I2S pin combinations available to you. The M4 boards have one option. Either way, if you'd like to know what options are available to you, copy the following code into your `code.py`, connect to the serial console, and check out the output.

These are the results from the ItsyBitsy M0 Express.

```

Adafruit CircuitPython 3.0.0 on 2018-07-09; Adafruit ItsyBitsy M0 Express with samd21g18
>>>
soft reboot

Auto-reload is on. Simply save files over USB to run them or enter REPL to disable.
code.py output:
Bit clock pin: board.D1      Word select pin: board.D0      Data pin: board.D4
Bit clock pin: board.D1      Word select pin: board.D0      Data pin: board.D9
Bit clock pin: board.D1      Word select pin: board.D0      Data pin: board.D12
Bit clock pin: board.D1      Word select pin: board.D7      Data pin: board.D4
Bit clock pin: board.D1      Word select pin: board.D7      Data pin: board.D9
Bit clock pin: board.D1      Word select pin: board.D7      Data pin: board.D12
Bit clock pin: board.D6      Word select pin: board.D0      Data pin: board.D4
Bit clock pin: board.D6      Word select pin: board.D0      Data pin: board.D9
Bit clock pin: board.D6      Word select pin: board.D0      Data pin: board.D12
Bit clock pin: board.D6      Word select pin: board.D7      Data pin: board.D4
Bit clock pin: board.D6      Word select pin: board.D7      Data pin: board.D9
Bit clock pin: board.D6      Word select pin: board.D7      Data pin: board.D12

```

```

import board
import audiobusio
from microcontroller import Pin

def is_hardware_i2s(bit_clock, word_select, data):
    try:
        p = audiobusio.I2SOut(bit_clock, word_select, data)
        p.deinit()
        return True
    except ValueError:
        return False

def get_unique_pins():
    exclude = ['NEOPIXEL', 'APA102_MOSI', 'APA102_SCK']
    pins = [pin for pin in [
        getattr(board, p) for p in dir(board) if p not in exclude]
        if isinstance(pin, Pin)]
    unique = []
    for p in pins:
        if p not in unique:
            unique.append(p)
    return unique

for bit_clock_pin in get_unique_pins():
    for word_select_pin in get_unique_pins():
        for data_pin in get_unique_pins():
            if bit_clock_pin is word_select_pin or bit_clock_pin is data_pin or word_select_pin\
               is data_pin:
                continue
            else:
                if is_hardware_i2s(bit_clock_pin, word_select_pin, data_pin):
                    print("Bit clock pin:", bit_clock_pin, "\t Word select pin:", word_select_pin,
                          "\t Data pin:", data_pin)
                else:
                    pass

```



## Downloads

## Files

- [EagleCAD PCB Files \(https://adafru.it/BtN\)](https://adafru.it/BtN)
- [Fritzing object in Adafruit Fritzing library \(https://adafru.it/aP3\)](https://adafru.it/aP3)
- [UDA1334A Datasheet \(https://adafru.it/BtO\)](https://adafru.it/BtO)

## Schematic & Fabrication Print

