

THIS DRAWING IS UNPUBLISHED.

RELEASED FOR PUBLICATION

2006

© COPYRIGHT 2006 BY -

ALL RIGHTS RESERVED.

REVISIONS

P	LTR	DESCRIPTION	DATE	DWN	APVD
C		CHANGE COLOR RAW MTL.	21NOV2008	AV	GT
D		RELEASED FOR PRODUCTION FROM -1 TO -9	31AUG2009	AV	GT
D1		UPDATED OVERALL LENGTH	22AUG2012	MZ	JC
D2		REVISED PER ECR-16-002347	22FEB2016	RS	JL

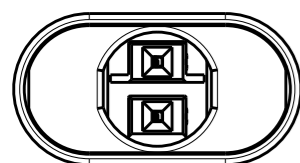

HV - 4

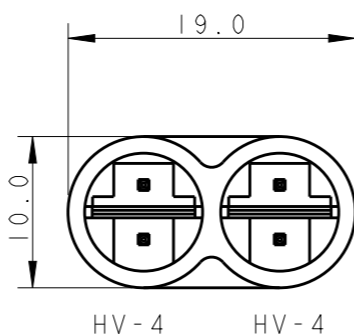
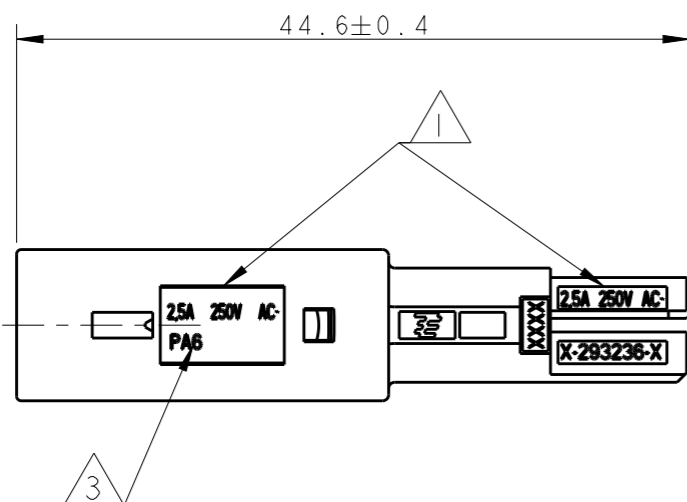

HV - 4 HV - 4

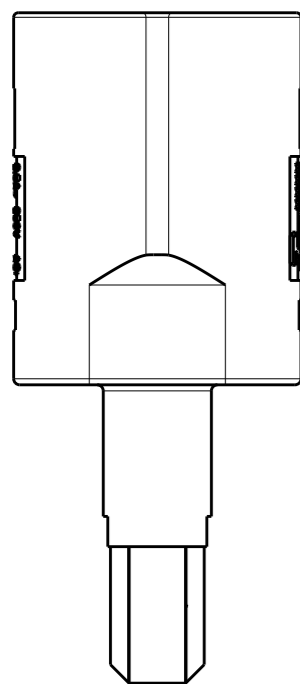
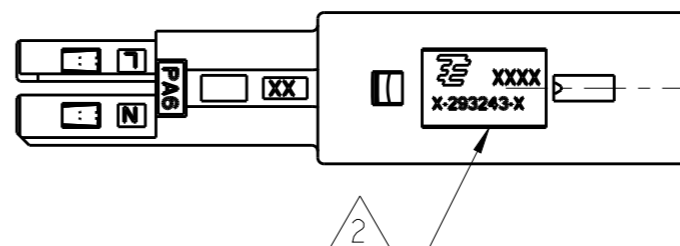

HV - 4

P/N 293234-1 AS SHOWN

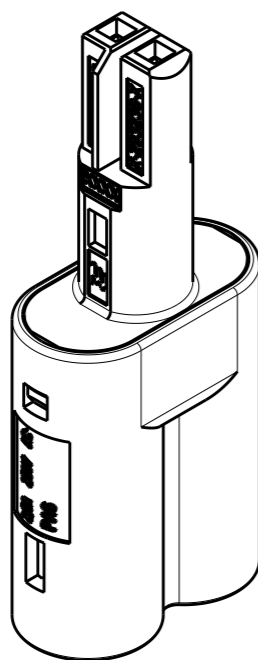

- 1 KEYING DEPENDENT TO THE MARKING
- 2 PART MARKING
-Tyco Electronics Product Identifier
Date code
Part number
- 3 RAW MATERIAL IDENTIFICATION PA6
- 4 OBSOLETED.

HV-1/HV-1&HV-1	0-293234-9	A	HIGH-VOLT 250V	2,5A 250V AC~	BLACK
LV-2/LV-2&LV-2	0-293234-8	B	LOW-VOLT 42V DC	7A 42V DC=	YELLOW
LV-1/LV-1&LV-1	0-293234-7	B	LOW-VOLT 42V AC	7A 42V AC~	LIGHT GREY
HV-5/HV-5&HV-5	0-293234-6	A	HIGH-VOLT 250V	2,5A 250V AC~	BLACK
HV-5/HV-5&HV-5	0-293234-5	A	HIGH-VOLT 250V	2,5A 250V AC~	WHITE
HV-3/HV-3&HV-3	0-293234-4	B	HIGH-VOLT 125V	6A 125V AC~	BLUE
HV-1/HV-1&HV-1	0-293234-3	A	HIGH-VOLT 250V	2,5A 250V AC~	WHITE
HV-4/HV-4&HV-4	0-293234-2	A	HIGH-VOLT 250V	2,5A 250V AC~	BLACK
HV-4/HV-4&HV-4	0-293234-1	A	HIGH-VOLT 250V	2,5A 250V AC~	WHITE
KEYING	P/N	REV.	REMARKS	MARKING	COLOR

THIS DRAWING IS A CONTROLLED DOCUMENT.

DWN 18AUG2006

A. Vecchia

CHK 18AUG2006

G. Turco

APVD 18AUG2006

G. Turco

PRODUCT SPEC

-

APPLICATION SPEC

-

WEIGHT

-

CUSTOMER DRAWING



TE Connectivity

NAME
T-SPLITTER CONNECTOR
STANDARD VERSION

-

SIZE

CAGE CODE

DRAWING NO

A300779 C-293234

RESTRICTED TO

SCALE 2:1

SHEET 1 OF 2

REV D2

DIMENSIONS:

mm

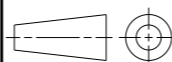

TOLERANCES UNLESS OTHERWISE SPECIFIED:

0 PLC	±-
1 PLC	±0.2
2 PLC	±0.1
3 PLC	±0.013
4 PLC	±0.0001
ANGLES	±-

MATERIAL

-

FINISH

-

THIS DRAWING IS UNPUBLISHED.

RELEASED FOR PUBLICATION

2006

© COPYRIGHT 2006 BY -

ALL RIGHTS RESERVED.

REVISIONS

P	LTR	DESCRIPTION	DATE	DWN	APVD
-	-	SEE SHEET 1	-	-	-

P/N 0-293234-3 AND P/N 293234-9 AS SHOWN



P/N 0-293234-5; 0-293234-6 AS SHOWN



P/N 0-293234-8 AS SHOWN



THIS DRAWING IS A CONTROLLED DOCUMENT.

DIMENSIONS:
mm

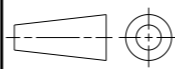

TOLERANCES UNLESS OTHERWISE SPECIFIED:

0 PLC	±.
1 PLC	±0.2
2 PLC	±0.1
3 PLC	±0.013
4 PLC	±0.0001
ANGLES	±.

MATERIAL

FINISH

DWN 18AUG2006

A. Vecchia

CHK 18AUG2006

G. Turco

APVD 18AUG2006

G. Turco

PRODUCT SPEC

-

APPLICATION SPEC

-

WEIGHT

-

CUSTOMER DRAWING



TE Connectivity

NAME
T-SPLITTER CONNECTOR
STANDARD VERSION

SIZE	CAGE CODE	DRAWING NO	RESTRICTED TO
------	-----------	------------	---------------

A300779	C-293234		
---------	----------	--	--

SCALE	SHEET	OF	REV
3:2	2	2	D2