



LK162A-4T

Including the LK162A-4T-USB variant

Technical Manual

Revision 1.0

PCB Revision: 1.0 or Higher

Firmware Revision: 7.2 or Higher

Revision History

Revision	Date	Description	Author
1.0	February 20, 2014	Initial Release	Clark

Contents

1 Introduction	1
2 Quick Connect Guide.....	2
2.1 Available Headers	2
2.2 Standard Module	3
Recommended Parts.....	3
Serial Connections.....	3
I ² C Connections	4
2.3 USB Module	5
Recommended Parts.....	5
USB Connections	5
3 Software	6
3.1 uProject.....	6
3.2 Application Notes.....	7
4 Hardware.....	8
4.1 Standard Model	8
Communication/Power Header	8
Protocol Select Jumpers.....	8
4.2 USB Model.....	9
Four Pin USB Header	9
4.3 Common Features.....	9
General Purpose Outputs	9
5 Troubleshooting.....	10
5.1 Power	10
5.2 Display.....	10
5.3 Communication.....	11
5.4 Manual Override	11
6 Commands	12
6.1 Communication.....	12
6.2 Text.....	13
6.3 Special Characters.....	15

6.4 General Purpose Output	17
6.5 Keypad.....	18
6.6 Display Functions	21
6.7 Data Security	22
6.8 Miscellaneous	23
7 Appendix	24
7.1 Command Summary	24
7.2 Character Sets	27
7.3 Block Diagram	28
7.4 Environmental Specifications.....	28
7.5 Electrical Tolerances	28
7.6 Dimensional Drawings	29
7.7 Optical Characteristics	30
8 Ordering	30
8.1 Part Numbering Scheme	30
8.2 Options.....	30
8.3 Accessories.....	31
9 Definitions.....	32
10 Contact	32

1 Introduction



Figure 1: LK162A-4T Display

The LK162A-4T is an intelligent alphanumeric liquid crystal display designed to decrease development time by providing an instant solution to any project. In addition to the RS232, TTL and I2C protocols available in the standard model, the USB communication model allows the LK162A-4T to be connected to a wide variety of host controllers. Communication speeds of up to 115.2kbps for serial protocols and 100kbps for I²C ensure lightning fast display updates.

The simple command structure permits easy software control of many settings including backlight brightness, screen contrast, and baud rate. On board memory provides up to forty custom characters which can be saved within the unit and recalled for start screens, bar graphs or larger numbers.

User input on the LK162A-4T is available through a four key, integrated tactile keypad and three bi-colour LEDs provide visual output. An additional two general purpose outputs on the back of the unit provide simple, switchable five volt sources.

The versatile LK162A-4T, with all the features mentioned above, is available in a variety of colour, voltage, and temperature options to suit almost any application.



2 Quick Connect Guide

2.1 Available Headers

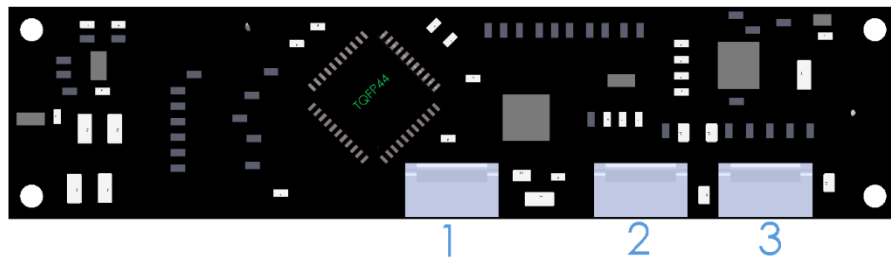

Figure 2: LK162A-4T Standard and USB Module Header Locations

Table 1: List of Available Headers

#	Header	Mate	Population
1	Mini USB Connector	EXTMUSB3FT/INTMUSB3FT	USB Model Only
2	GPO Header	None Offered	All Models
3	Communication/Power Connector	SCCPC5V/BBC	Standard Model Only

2.2 Standard Module

The standard version of the LK162A-4T allows for user configuration of three common communication protocols. First, the unit can communicate using serial protocol at either RS232 or TTL voltage levels. Second, it can communicate using the Inter-Integrated Circuit connect, or I²C protocol. Connections for each protocol can be accessed through the four pin Communication/Power Header as outlined in the Serial Connections and I²C Connections sections below.

Recommended Parts



Figure 3: Communication/Power Cable (SCCPC5V)

The most common cable choice for any alphanumeric Matrix Orbital Display, the Communication/ Power Cable offers a simple connection to the unit with familiar interfaces. DB9 and floppy power headers provide all necessary input to drive your display.



Figure 4: Breadboard Cable (BBC)

For a more flexible interface to the LK162A-4T a Breadboard Cable may be used. This provides a simple four wire connection that is popular among developers for its ease of use in a breadboard environment.

Serial Connections

A serial interface provides a classic connection to the LK162A-4T. The Communication/Power Cable is most commonly used for this set up as it provides connections for DB9 serial and floppy power cables. To place your board in Serial mode, adhere to the steps laid out below.

1. Set the Protocol Select jumpers.
 - RS232: Connect the three jumpers* in the 232 protocol box with the zero ohm jumper resistors provided or an alternate wire or solder solution.
 - TTL: Connect the two jumpers* in the TTL protocol box.

***Note:** Jumpers must be removed from all protocol boxes save for the one in use.



2. Make the connections.
 - a. Connect the four pin female header of the Communication/Power Cable to the Communication/Power Header of your LK162A-4T.
 - b. Insert the male end of your serial cable to the corresponding DB9 header of the Communication/Power Cable and mate the female connector with the desired communication port of your computer.
 - c. Select an unmodified floppy cable from a PC power supply and connect it to the power header of the Communication/Power Cable.
3. Create.
 - Use uProject or a terminal program to get started, and then move on with your own development. A number of application notes are available at www.matrixorbital.ca/appnotes.

I²C Connections

A more advanced connection to the LK162A-4T is provided by the I²C protocol setting. This is best accomplished using a breadboard and the Breadboard Cable. Power must be supplied from your breadboard or another external source. To dive right into your application and use the LK162A-4T in I²C mode, get started with the guidelines below.

1. Set the Protocol Select switches.
 - I²C: Ensure that the two I²C jumpers in the corresponding protocol box are connected while all others are open.
2. Make the connections.
 - a. Connect the Breadboard Cable to the Communication/Power Header on your LK162A-4T and plug the four leads into your breadboard. The red lead will require power, while the black should be connected to ground, and the green and yellow should be connected to your controller clock and data lines respectively.
 - b. Pull up the clock and data lines to five volts using a resistance between one and ten kilohms on your breadboard.
3. Create.
 - This time you're on your own. While there are many examples within the Matrix Orbital AppNote section, www.matrixorbital.ca/appnotes, too many controllers and languages exist to cover them all. If you get stuck in development, it is possible to switch over to another protocol on the standard board, and fellow developers are always on our forums for additional support.



2.3 USB Module

The LK162A-4T-USB offers a single USB protocol for an easy connection to a host computer. This simple and widely available protocol can be accessed using the on-board keyed, friction lock style USB connector as outlined in the USB Connections section.

Recommended Parts



Figure 5: Four Pin USB Cable
(CBL-USBA24PIN3FT)

The Four Pin USB cable is recommended for the LK162A-4T-USB display. It will connect to the keyed, friction lock style header on the unit and provide a connection to a regular A style USB connector, commonly found on a PC.

USB Connections

The USB connection is the quickest, easiest solution for PC development. After driver installation, the LK162A-4T-USB will be accessible through a virtual serial port, providing the same result as a serial setup without the cable hassle. To connect to your LK162A-4T-USB please follow the steps below.

1. Set the Protocol Select jumpers.
 - USB: The LK162A-4T-USB offers USB protocol only. Model specific hardware prevents this unit from operating in any other protocol, and does not allow other models to operate in USB. Protocol Select jumpers on the USB model cannot be moved.
2. Make the connections.
 - Plug the mini-B header of your External Mini USB cable into your LK162A-4T-USB and the regular USB header into your computer USB jack.
3. Install the drivers.
 - a. Download the latest drivers at www.matrixorbital.ca/drivers, and save them to a known location.
 - b. When prompted, install the USB bus controller driver automatically
 - c. If asked, continue anyway, even though the driver is not signed
 - d. When the driver install is complete, your display will turn on, but communication will not yet be possible.
 - e. At the second driver prompt, install the serial port driver automatically
 - f. Again, if asked, continue anyway
4. Create.
 - Use uProject or a terminal program to get started, and then move on with your own development. A number of application notes are available at www.matrixorbital.ca/appnotes.



3 Software

The multiple communication protocols available and simple command structure of the LK162A-4T means that a variety of applications can be used to communicate with the display. Text is sent to the display as a character string, for example, sending the decimal value 41 will result in an 'A' appearing on the screen. A number of control characters are also activated. Commands are merely values prefixed with a special command byte, 254 in decimal.

Table 2: Reserved Control Characters

Control Characters							
8	Backspace	10	Line feed / New line	12	Clear screen / New page	13	Carriage return

Once the correct communication port is identified, the following communication settings can be applied to communicate correctly with the LK162A-4T.

Table 3: Communication Settings

BPS	Data Bits	Parity	Stop Bits	Flow Control
19200	8	None	1	None

Finally, with a communication port identified and correctly setup simple text strings or even command bytes can easily be transmitted to control your display.

3.1 uProject

The Matrix Orbital alphanumeric display tuner, or uProject, is offered as a free download from the www.matrixorbital.ca support site. It allows the basic functionality of *any display to be tested using a simple graphical user interface system.

While basic functionality can be tested using the GUI portion of the program, more advanced users will enjoy the scripting capability found in the uploader tab. Here commands can be stacked, run, and saved for later use. Although many commands are available to be dragged into the script dialog, perhaps the most powerful is the raw data command found in the other branch.

***Note:** The uProject AutoDetect function will not perform correctly when a USB display is connected. Please manually configure any USB display.



This command allows raw bytes to be sent to the display, permitting many different formats for entry and displaying in decimal notation. Any command from this manual may be entered in decimal notation separated by slashes.

/254/ /88/

Figure 6: uProject Command

Again, the clear screen command is sent to a connected display, this time using uProject raw data command style. Scripts can be run as a whole using the execute command from the script menu, or as single commands by selecting execute once. Before issuing commands, it is a good idea to ensure communication with a display is successful using some of the more basic GUI functions in the main window.

This program provides scratch pad upon which a tome of display projects and ideas can be assembled.

3.2 Application Notes

Full demonstration programs and code are available for Matrix Orbital Displays in the C# language from Simple C# AppNote Pack in the Application Note section at www.matrixorbital.ca/appnotes. Difficulty increases from beginner, with the Hello World program, to advanced with the Dallas One-Wire temperature reading application.

Many additional applications are available in a number of different programming languages. These programs are meant to showcase the capability of the display and are not intended to be integrated into a final design. For additional information regarding code, please read the On Code document also found on the support site.



4 Hardware

4.1 Standard Model

Communication/Power Header

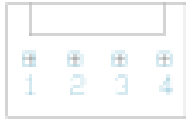

Figure 7: Communication/Power Header

Table 4: Communication/Power Pinout

Pin	Function
1	Vcc
2	Rx (SCL)
3	Tx (SDA)
4	Gnd

The Communication/Power Header provides a standard connector for interfacing to the LK162A-4T. Voltage is applied through pins one and four of the four pin Communication/Power Header. Please ensure the correct voltage input for your display by referencing Voltage Specifications before connecting power. Pins two and three are reserved for serial transmission, using either the RS-232/TTL or clocking data through the I²C protocol, depending on what has been selected by the Protocol Select Jumpers. The versatile Tyco 640456-4-LF style header used can be mated to a number of connectors, the Molex 22-01-3047 for example.

Protocol Select Jumpers

The Protocol Select Jumpers provide the means necessary to toggle the LK162A-4T between RS-232, TTL and I²C protocols. As a default, the jumpers are set to RS-232 mode with solder jumps on the RS232 jumpers. In order to place the display module in I²C mode you must first remove the solder jumps from the RS232 jumpers and then place them on the I²C jumpers. The display will now be in I²C mode and have a default slave address of 80, unless changed with the appropriate command. Similarly, in order to change the display to TTL mode, simply remove the zero ohm resistors from the RS232 or I²C jumpers and solder them to the TTL jumpers.

4.2 USB Model

Four Pin USB Header

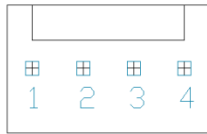

Figure 8: Four Pin USB Header

Table 5: USB Pinout

Pin	Function
1	GND
2	D+
3	D-
4	Vcc

The LK162A-4T-USB comes with a keyed, friction lock style USB connector to fulfill both communication and power needs. This special header requires a CBL-USBA24PIN3FT cable. Most commonly used with a PC, this connection creates a virtual com port that offers a simple power solution with a familiar communication scheme.

4.3 Common Features

General Purpose Outputs

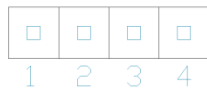

Figure 9: GPO Header

Table 6: GPO Pinout

Pin	Function
1	GPO 1
2	GND
3	GPO 2
4	GND

A unique feature of the LK162A-4T is the ability to control relays* and other external devices using either one of two General Purpose Outputs. Each can source up to 10mA of current at five volts when on or sink 20mA at zero volts when off. The single row, four pin header can be interfaced to a number of female connectors to provide control to any peripheral devices required.

***Note:** If connecting a relay, be sure that it is fully clamped using a diode and capacitor in order to absorb any electro-motive force (EMF) which will be generated.



5 Troubleshooting

5.1 Power

In order for your LK162A-4T to function correctly, it must be supplied with the appropriate power. If the power LED near the top right corner of the board is not illuminated, power is not applied correctly. Try following the tips below.

- First, make sure that you are using the correct power connector. Standard floppy drive power cables from your PC power supply may fit on the Communication/Power Header; however they do not have the correct pin out to provide power. Matrix Orbital supplies power cable adapters for connecting to a PC, which can be found in the accessories section.
- Next, check the power cable which you are using for continuity. If you don't have an ohm meter, try using a different power cable, if this does not help try using a different power supply.
- If changes have been made to the protocol select block, ensure all the appropriate protocol select jumpers are connected and all unused protocol jumpers are disconnected.
- The last step will be to check the interface connector in use on your display. If the power connections have become loose, or you are unable to resolve the issue, please Contact Matrix Orbital for more information.

5.2 Display

If your display is powered successfully, the Matrix Orbital logo, or user created screen should display on start up. If this is not the case, check out these tips.

- Ensure the contrast is not too high or too low. This can result in a darkened or blank screen respectively. See the Manual Override section to reset to default.
- Make sure that the start screen is not blank. It is possible to overwrite the Matrix Orbital logo start screen, if this happens the screen may be blank. Try writing to the display to ensure it is functional, after checking the contrast above.



5.3 Communication

When communication of either text or commands is interrupted, try the steps below.

- First, check the communication cable for continuity. If you don't have an ohm meter, try using a different communication cable. If you are using a PC try using a different Com/USB Port.
- Next, please ensure that the display module is set to communicate on the protocol that you are using, by checking the Protocol Select Jumpers.
- In serial and USB protocols, ensure that the host system and display module are both communicating on the same baud rate. The default rate for the display module is 19200 bps.
- Match Rx from your display to the transmitting pin from your host and the Tx pin to the receiving pin.
- If you are communicating to the display via I²C* please ensure that the data is being sent to the correct address. The default slave address for the display module is 80.
- In I²C mode, connect Rx to the clock line of your controller and Tx to the data output.
- Unlock the display. See the Set and Save Data Lock command for more info.
- Finally, you may reset the display to its default settings using the Manual Override procedure outlined below.

***Note:** I²C communication will always require pull up resistors on SCL and SDA of one to ten kilohms.

5.4 Manual Override

Should the settings of your display become altered in a way that dramatically impacts usability, the default settings can be temporarily restored. To override the display, please follow the steps below.

1. Disconnect power from your display.
2. Hold down the bottom arrow key.
3. Reconnect power to your unit, and wait for the start screen before releasing the key.
4. Settings will be temporarily* overridden to the defaults listed in the Manual Override Settings table. At this point any important settings, such as contrast, backlight, or baud rate, should not only be set but saved so they remain when the override is removed.

Parameter	Value
Backlight	255
Contrast	128
Baud Rate	19200
I ² C Address	80

Table 7: Manual Override Settings

***Note:** The display module will revert back to the old settings once turned off, unless desired settings are saved.



6 Commands

6.1 Communication

1.1 Change Baud Rate	Dec	254 57	Speed	v7.2
	Hex	FE 39	Speed	
	ASCII	■ 9	Speed	
Immediately changes the baud rate. Not available in I2C. Baud rate can be temporarily forced to 19200 by a manual override.				
Speed	Byte	Valid settings shown below.		

Table 8: Accepted Baud Rate Values

Rate	1200	2400	4800	9600	19200	28800	38400	57600	76800	115200
Speed	83	41	207	103	51	34	25	16	12	8

1.2 Change I²C Slave Address	Dec	254 51	Address	v7.2
	Hex	FE 33	Address	
	ASCII	■ 3	Address	
Immediately changes the I ² C write address. Only even values are permitted as the next odd address will become the read address. Default is 80.				
Address	Byte	Even value.		

1.3 Transmission Protocol Select	Dec	254 160	Protocol	v7.2
	Hex	FE A0	Protocol	
	ASCII	■ á	Protocol	
Selects the protocol used for data transmission from the display. Data transmission to the display is not affected. Must be set to the protocol in use to receive data correctly.				
Protocol	Byte	1 for Serial (RS232/RS422/TTL/USB) or 0 for I ² C.		

1.4 Set a Non-Standard Baud Rate	Dec	254 164	Speed	v7.2
	Hex	FE A4	Speed	
	ASCII	■ ñ	Speed	
Immediately changes the baud rate to a non-standard value. Speed must be a whole number between 977 and 153800. Due to rounding, error increases with baud rate, actual baud must be within 3% of desired baud to ensure accurate communication. Not available in I2C. Can be temporarily forced to 19200 by a manual override.				
Speed	Word	Calculations shown below, standard crystal speed is 16MHz.		

$$Speed = \frac{CrystalSpeed}{(8 \times DesiredBaud)} - 1 \quad ActualBaud = \frac{CrystalSpeed}{(8 \times (Speed + 1))}$$

Equation 1: Speed Byte Calculation Equation 2: Actual Baud Rate Calculation

$$\frac{|DesiredBaud - ActualBaud|}{DesiredBaud} < 0.03$$

Equation 3: Baud Rate Error Calculation



1.5 Software Reset	Dec	254 253 77 79 117 110	v8.4
	Hex	FE FD 4D 4F 75 6E	
	ASCII	■ ²M O u n	

Reset the display as if power had been cycled via a software command. No commands should be sent while the unit is in the process of resetting; a response will be returned to indicate the unit has successfully been reset.

Response | **Short** | Successful reset response, 254 212.

6.2 Text

2.1 Clear Screen	Dec	254 88	v7.2
	Hex	FE 58	
	ASCII	■ X	

Clears the contents of the screen.

2.2 Change the Start Up Screen	Dec	254 64	Characters	v7.2
	Hex	FE 40	Characters	
	ASCII	■ @	Characters	

Changes the message displayed on start up. Custom characters can be included by adding their decimal value (0-7). Characters will automatically wrap on the display.

Characters | 32 bytes, space characters can be added as needed

2.3 Auto Scroll On	Dec	254 81	v7.2
	Hex	FE 51	
	ASCII	■ Q	

The entire contents of screen are shifted up one line when the end of the screen is reached. Display default is on.

2.4 Auto Scroll Off	Dec	254 82	v7.2
	Hex	FE 52	
	ASCII	■ R	

New text is written over the top line when the end of the screen is reached. Display default is Auto Scroll on.

2.5 Set Auto Line Wrap On	Dec	254 67	v7.2
	Hex	FE 43	
	ASCII	■ C	

Text will wrap to the next consecutive line once a row becomes full. Default is Auto Line Wrap on.

2.6 Set Auto Line Wrap Off	Dec	254 68	v7.2
	Hex	FE 44	
	ASCII	■ D	

Text will skip one line when wrapping once a row becomes full. Writing order will be rows 1, 3, 2, and then 4. Default is Auto Line Wrap on.



2.7 Set Cursor Position	Dec	254 71	Column Row	v7.2
	Hex	FE 47	Column Row	
	ASCII	■ G	Column Row	
Sets the cursor to a specific cursor position where the next transmitted character is printed.				
Column	Byte	Value between 1 and number of character columns.		
Row	Byte	Value between 1 and number of character rows.		

2.8 Go Home	Dec	254 72		v7.2
	Hex	FE 48		
	ASCII	■ H		
Returns the cursor to the top left of the screen.				

2.9 Move Cursor Back	Dec	254 76		v7.2
	Hex	FE 4C		
	ASCII	■ L		
Moves cursor one position to the left. Cursor will obey wrap settings.				

2.10 Move Cursor Forward	Dec	254 77		v7.2
	Hex	FE 4D		
	ASCII	■ M		
Moves cursor one position to the right. Cursor will obey wrap settings.				

2.11 Underline Cursor On	Dec	254 74		v7.2
	Hex	FE 4A		
	ASCII	■ J		
Displays a line under the current cursor position. Can be used with block cursor.				

2.12 Underline Cursor Off	Dec	254 75		v7.2
	Hex	FE 4B		
	ASCII	■ K		
Removes line under current cursor position.				

2.13 Blinking Block Cursor On	Dec	254 83		v7.2
	Hex	FE 53		
	ASCII	■ S		
Displays a blinking block over the current cursor position. Can be used with underline.				

2.14 Blinking Block Cursor Off	Dec	254 84		v7.2
	Hex	FE 54		
	ASCII	■ T		
Removes blinking block over current cursor position.				



6.3 Special Characters

3.1 Create a Custom Character	Dec	254 78	ID Data	v7.2
	Hex	FE 4E	ID Data	
	ASCII	■ N	ID Data	

Creates a custom character. Each character is divided into 8 rows of 5 pixels; each data byte represents one row. Each byte is padded by three zero bits followed by five bits representing each pixel state. A one represents an on condition while a zero is off. Characters are lost when a new memory bank is loaded, unless they are saved.

ID	Byte	Character ID, value between 0 and 7.
Data	Byte[8]	Character pixel data as shown below.

Table 9: Custom Degree Character

Data[1]	000	p1	p2	p3	p4	p5	00001000	8
Data[2]	000	p1	p2	p3	p4	p5	00010100	20
Data[3]	000	p1	p2	p3	p4	p5	00001000	8
Data[4]	000	p1	p2	p3	p4	p5	00000011	3
Data[5]	000	p1	p2	p3	p4	p5	00000100	4
Data[6]	000	p1	p2	p3	p4	p5	00000100	4
Data[7]	000	p1	p2	p3	p4	p5	00000011	3
Data[8]	000	p1	p2	p3	p4	p5	00000000	0

3.2 Save Custom Characters	Dec	254 193	Bank ID Data	v7.2
	Hex	FE C1	Bank ID Data	
	ASCII	■ ñ	Bank ID Data	

Provides access to all memory banks to create and save custom characters, graph bars, and large digits. Any new characters saved will overwrite the old, so care should be taken when writing to any bar or digit memory bank. Bank structure is shown below.

Bank	Byte	1 byte, memory bank ID, value between 0 and 4, as below.
ID	Byte	1 byte, value between 0 and 7.
Data	Byte[8]	8 bytes, character pixel data as above.

Table 10: Custom Character Banks

0	Start-up Characters	1	Horizontal Bars	2	Vertical Bars	3	Medium Digits	4	Large Digits
----------	---------------------	----------	-----------------	----------	---------------	----------	---------------	----------	--------------

3.3 Load Custom Characters	Dec	254 192	Bank	v7.2
	Hex	FE C0	Bank	
	ASCII	■ L	Bank	

Loads a bank of custom characters into memory for use. Must be issued before using a bank of characters. Alternatively, an appropriate initialize command can be used.

Bank	Byte	Memory bank ID, value between 0 and 4, as above.
-------------	-------------	--



3.4 Save Start Up Screen Custom Characters	Dec	254 194	ID Data	v7.2
	Hex	FE C2	ID Data	
	ASCII	■ T	ID Data	
Saves a custom character to memory for the start up screen or repeated use. Start up characters are displayed by sending their ID to the screen.				
ID	Byte	Value between 0 and 7.		
Data	Byte[8]	Character pixel data, see Custom Degree Character example.		

3.5 Initialize Medium Numbers	Dec	254 109		v7.2
	Hex	FE 6D		
	ASCII	■ m		
Loads the medium number custom character bank into memory. Medium numbers must be initialized before use.				

3.6 Place Medium Numbers	Dec	254 111	Row Column Digit	v7.2
	Hex	FE 6F	Row Column Digit	
	ASCII	■ o	Row Column Digit	
Places a single medium decimal digit of 2 row height and 1 column width on the display at the position specified. Medium numbers must be initialized before being placed.				
Row	Byte	Value between 1 and 20.		
Column	Byte	Value between 1 and 4.		
Digit	Byte	Single decimal digit to display.		

3.7 Initialize Horizontal Bar	Dec	254 104		v7.2
	Hex	FE 68		
	ASCII	■ h		
Loads the horizontal bar graph custom character bank into memory. Horizontal bar characters must be initialized before a graph is displayed.				

3.8 Place Horizontal Bar Graph	Dec	254 124	Column Row Direction Length	v7.2
	Hex	FE 7C	Column Row Direction Length	
	ASCII	■ 	Column Row Direction Length	
Places a horizontal bar graph on the screen beginning at the column and row specified. The bar extends either right or left to the length indicated. New bars will overwrite old.				
Column	Byte	1 byte, value between 1 and 20		
Row	Byte	1 byte, value between 1 and 4		
Direction	Byte	1 byte, 0 for right and 1 for left		
Length	Byte	1 byte, length in pixels of the graph, value between 0 and 100		



3.9 Initialize Narrow Vertical Bar	Dec	254 115		v7.2
	Hex	FE 73		
	ASCII	■ s		

Loads the narrow horizontal bar graph custom character bank into memory. A narrow bar is 2 pixels wide. Horizontal bar characters must be initialized before a graph is displayed.

3.10 Initialize Wide Vertical Bar	Dec	254 118		v7.2
	Hex	FE 76		
	ASCII	■ v		

Loads the wide horizontal bar graph custom character bank into memory. A wide bar is 5 pixels wide. Horizontal bar characters must be initialized before a graph is displayed.

3.11 Place Vertical Bar	Dec	254 61	Column Length	v7.2
	Hex	FE 3D	Column Length	
	ASCII	■ =	Column Length	

Places a vertical bar graph on the screen extending from the first row of the column specified. The bar extends upwards to the length indicated. A new bar will over write the old.

Column	Byte	Value between 1 and 20.
Length	Byte	Height in pixels of the graph, value between 0 and 32.

6.4 General Purpose Output

4.1 General Purpose Output On	Dec	254 87	Number	v7.2
	Hex	FE 57	Number	
	ASCII	■ W	Number	

Turns the specified GPO on, sourcing current from an output of five volts.

Number	Byte	GPO to be turned on.
---------------	-------------	----------------------

4.2 General Purpose Output Off	Dec	254 86	Number	v7.2
	Hex	FE 56	Number	
	ASCII	■ V	Number	

Turns the specified GPO off, sinking current to an output of zero volts.

Number	Byte	GPO to be turned off.
---------------	-------------	-----------------------

4.3 Set Start Up GPO State	Dec	254 195	Number State	v7.2
	Hex	FE C3	Number State	
	ASCII	■ 	Number State	

Sets and saves the start up state of the specified GPO in non volatile memory. Changes will be seen on start up.

Number	Byte	GPO to be controlled.
State	Byte	1 for on or 0 for off.



LED Indicators

The LK162A-4T has 6 General Purpose Outputs which control 3 bi-colour LEDs. Red, green, and orange-yellow colours can be created using these software controlled GPOs. Odd numbered GPOs control red while even numbers switch the green aspects of the LEDs, as shown in the table below.

Table 11: LED Output

Colour	GPO _O	GPO _E
Yellow	0	0
Green	0	1
Red	1	0
Off	1	1

4.4 Set LED Indicators		Dec	254 90	Number Colour	v8.0
		Hex	FE 5A	Number Colour	
		ASCII	■ Z	Number Colour	
Immediately sets the state of the specified LED indicator to a specific colour. Temporary unless remember is on.					
Number	Byte	LED indicator to be controlled.			
Colour	Byte	LED colour state as below.			

Table 12: LED Indicator Colour

State	Colour
Off	0
Green	1
Red	2
Yellow	3

6.5 Keypad

5.1 Auto Transmit Key Presses On		Dec	254 65	v7.2
		Hex	FE 41	
		ASCII	■ A	
Key presses are automatically sent to the host when received by the display. Default is Auto Transmit on.				

5.2 Auto Transmit Key Presses Off		Dec	254 79	v7.2
		Hex	FE 4F	
		ASCII	■ O	
Key presses are held in the 10 key buffer to be polled by the host using the Poll Key Press command. Use this mode for I2C transactions. Default is Auto Transmit on.				



5.3 Poll Key Press	Dec	254 38	v7.2
	Hex	FE 26	
	ASCII	■ &	

Reads the last unread key press from the 10 key display buffer. If another key is stored in the buffer the MSB will be 1, the MSB will be 0 when the last key press is read. If there are no stored key presses a value of 0 will be returned. Auto transmit key presses must be turned off for this command to be successful.

Response | **Byte** | Value of key pressed (MSb determines additional keys to be read).

5.4 Clear Key Buffer	Dec	254 69	v7.2
	Hex	FE 45	
	ASCII	■ E	

Clears all key presses from the key buffer.

5.5 Set Debounce Time	Dec	254 85	Time	v7.2
	Hex	FE 55	Time	
	ASCII	■ U	Time	

Sets the time between a key press and a key read by the display. Most switches will bounce when pressed; the debounce time allows the switch to settle for an accurate read. Default is 8 representing approximately 52ms.

Time | **Byte** | Debounce increment (debounce time = **Time** * 6.554ms).

5.6 Set Auto Repeat Mode	Dec	254 126	Mode	v7.2
	Hex	FE 7E	Mode	
	ASCII	■ DEL	Mode	

Sets key press repeat mode to typematic or hold. In typematic mode if a key press is held, the key value is transmitted immediately, then 5 times a second after a 1 second delay. In hold mode, the key down value is transmitted once when pressed, and then the key up value is sent when the key is released. Default is typematic.

Mode | **Byte** | 1 for hold mode or 0 for typematic.

5.7 Auto Repeat Mode Off	Dec	254 96	v7.2
	Hex	FE 60	
	ASCII	■ `	

Turns auto repeat mode off. Default is on (typematic).



5.8 Assign Keypad Codes	Dec	254 213	Key Down Key Up	v7.2
	Hex	FE D5	Key Down Key Up	
	ASCII	■ F	Key Down Key Up	

Assigns the key down and key up values sent to the host when a key press is detected. A key up and key down value must be sent for every key, a value of 255 will leave the key unaltered. Defaults are shown below.

Key Down	Bytes [4]	Key down values, beginning at row one column one moving right then down.
Key Up	Bytes [4]	Key up values, beginning at row one column one moving right then down.

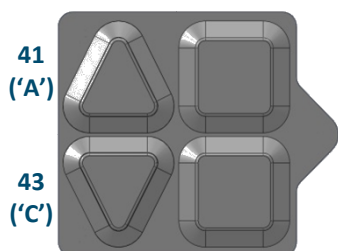

Figure 10: Default Tactile Key Down Values

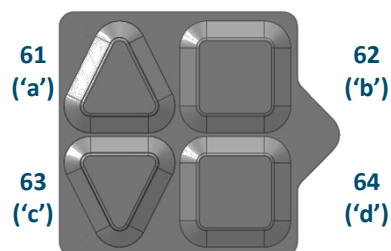

Figure 11: Default Tactile Key Up Values

5.9 Keypad Backlight Off	Dec	254 155	v7.2
	Hex	FE 9B	
	ASCII	■ ¢	

Turns the keypad backlight off.

5.10 Set Keypad Brightness	Dec	254 156	Brightness	v7.2
	Hex	FE 9C	Brightness	
	ASCII	■ £	Brightness	

Immediately sets the keypad brightness. On time is set using the Backlight On command. Default is 255.

Brightness	Byte	Brightness level from 0(Dim) to 255(Bright).
-------------------	-------------	--

5.11 Set Auto Backlight	Dec	254 157	Setting	v7.2
	Hex	FE 9D	Setting	
	ASCII	■ ¥	Setting	

Set the way the display and keypad backlights respond when a key is pressed. The options in the tables below allow a keypress to turn on the display and/or keypad backlights after they have timed out or been turned off.

Setting	Byte	What portions of the unit light on a keypress, if any, and if that press is returned.
----------------	-------------	---

Table 13: AutoBacklight Settings

Transmit First Keypress		Omit First Keypress	
0	No Lighting Change	8	No Lighting Change
1	Light Keypad Backlight	9	Light Keypad Backlight
2	Light Display Backlight	10	Light Display Backlight
3	Light Keypad and Display	11	Light Keypad and Display



6.6 Display Functions

6.1 Backlight On	Dec	254 66	Minutes	v7.2
	Hex	FE 42	Minutes	
	ASCII	■ B	Minutes	

Turns the display backlight on for a specified length of time. If an inverse display color is used this command will essentially turn on the text.

Minutes | **Byte** | Number of minutes to leave backlight on, a value of 0 leaves the display on indefinitely.

6.2 Backlight Off	Dec	254 70		v7.2
	Hex	FE 46		
	ASCII	■ F		

Turns the display backlight off. If an inverse display colour is used this command will turn off the text.

6.3 Set Brightness	Dec	254 153	Brightness	v7.2
	Hex	FE 99	Brightness	
	ASCII	■ Ö	Brightness	

Immediately sets the backlight brightness. If an inverse display color is used this represents the text colour intensity instead. Default is 255.

Brightness | **Byte** | Brightness level from 0(Dim) to 255(Bright).

6.4 Set and Save Brightness	Dec	254 152	Brightness	v7.2
	Hex	FE 98	Brightness	
	ASCII	■ ÿ	Brightness	

Immediately sets and saves the backlight brightness. Although brightness can be changed using the set command, it is reset to this saved value on start up. Default is 255.

Brightness | **Byte** | Brightness level from 0(Dim) to 255(Bright).

6.5 Set Backlight Colour	Dec	254 130	Red Green Blue	v7.2
	Hex	FE 82	Red Green Blue	
	ASCII	■ é	Red Green Blue	

Set the colour of a tri-colour backlight. Only for tri-colour displays. Default is white (255, 255, 255).

Red | **Byte** | Brightness level of Red from 0(Dim) to 255(Bright).

Green | **Byte** | Brightness level of Green from 0(Dim) to 255(Bright).

Blue | **Byte** | Brightness level of Blue from 0(Dim) to 255(Bright).

6.6 Set Contrast	Dec	254 80	Contrast	v7.2
	Hex	FE 50	Contrast	
	ASCII	■ P	Contrast	

Immediately sets the contrast between background and text. If an inverse display color is used this also represents the text brightness. Default is 128.

Contrast | **Byte** | Contrast level from 0(Light) to 255(Dark).



6.7 Set and Save Contrast	Dec	254 145	Contrast	v7.2
	Hex	FE 91	Contrast	
	ASCII	■ æ	Contrast	

Immediately sets and saves the contrast between background and text. Although contrast can be changed using the set command, it is reset to this saved value on start up. Default is 128.

Contrast **Byte** Contrast level from 0(Light) to 255(Dark).

6.7 Data Security

7.1 Set Remember	Dec	254 147	Switch	v7.2
	Hex	FE 93	Switch	
	ASCII	■ ô	Switch	

Allows changes to specific settings to be saved to the display memory. Writing to non-volatile memory can be slow and each change consumes 1 write of at least 100,000 available. The Command Summary outlines which commands are saved always, never, and when this command is on only. Remember is off by default.

Switch **Byte** 1 for on or 0 for off.

7.2 Set Data Lock	Dec	254 202 245 160	Level	v7.2
	Hex	FE CA F5 A0	Level	
	ASCII	■ J̄ J á	Level	

Temporarily locks certain aspects of the display to ensure no inadvertent changes are made. The lock is released after a power cycle. A new level overrides the old, and levels can be combined. Default is 0.

Level **Byte** Lock level, see Data Lock Bits table.

Table 14: Data Lock Bits

Display	Command	Reserved	Setting	Address	Reserved	Reserved	Reserved
7	6	5	4	3	2	1	0

Table 15: Lock Parameters

Reserved	Place holders only, should be 0
Address	Locks the Baud Rate and I2C address
Setting	Locks all settings from being saved
Command	Locks all commands, text can still be written
Display	Locks entire display, no new text can be displayed

7.3 Set and Save Data Lock	Dec	254 203 245 160	Level	v7.2
	Hex	FE CB F5 A0	Level	
	ASCII	■ J̄ J á	Level	

Locks certain aspects of the display to ensure no inadvertent changes are made. The lock is not affected by a power cycle. A new level overrides the old, and levels can be combined. Default is 0.

Level **Byte** See Data Lock Bits table.



6.8 Miscellaneous

8.1 Write Customer Data	Dec	254 52	Data	v7.2
	Hex	FE 34	Data	
	ASCII	■ 4	Data	

Saves a user defined block of data to non-volatile memory. Useful for storing display information for later use.

Data	Byte [16]	User defined data.
-------------	------------------	--------------------

8.2 Read Customer Data	Dec	254 53	v7.2
	Hex	FE 35	
	ASCII	■ 5	

Reads data previously written to non-volatile memory. Data is only changed when written, surviving power cycles.

Response	Byte [16]	Previously saved user defined data.
-----------------	------------------	-------------------------------------

8.3 Read Version Number	Dec	254 54	v7.2
	Hex	FE 36	
	ASCII	■ 6	

Causes display to respond with its firmware version number. Test.

Response	Byte	Convert to hexadecimal to view major and minor revision numbers.
-----------------	-------------	--

8.4 Read Module Type	Dec	254 55	v7.2
	Hex	FE 37	
	ASCII	■ 7	

Causes display to respond with its module number.

Response	Byte	Module number, see Sample Module Type Responses for a partial list.
-----------------	-------------	---

Table 16: Sample Module Type Responses

50	LK162B-7T-1U	60	LK162A-4T-1U
62	LK162A-4T-1U-USB	63	LK162B-7T-1U-USB



7 Appendix

7.1 Command Summary

Available commands below include identifying number, required parameters, the returned response and an indication of whether settings are remembered always, never, or with remember set to on.

Table 17: Communication Command Summary

Name	Dec	Hex	ASCII	Parameters	Response	Remembered
Change Baud Rate	57	39	9	Byte	None	Always
Change I ² C Slave Address	51	33	3	Byte	None	Always
Transmission Protocol Select	160	A0	á	Byte	None	Remember On
Set a Non-Standard Baud Rate	164	A4	ñ	Byte	None	Always
Software Reset	253	FD	²	Byte[4]	Byte[2]	Never

Table 18: Text Command Summary

Name	Dec	Hex	ASCII	Parameters	Response	Remembered
Clear Screen	88	58	X	None	None	Never
Change the Start Up Screen	64	40	@	Byte[]	None	Always
Auto Scroll On	81	51	Q	None	None	Remember On
Auto Scroll Off	82	52	R	None	None	Remember On
Set Auto Line Wrap On	67	43	C	None	None	Remember On
Set Auto Line Wrap Off	68	44	D	None	None	Remember On
Set Cursor Position	71	47	G	Byte[2]	None	Never
Go Home	72	48	H	None	None	Never
Move Cursor Back	76	4C	L	None	None	Never
Move Cursor Forward	77	4D	M	None	None	Never
Underline Cursor On	74	4A	J	None	None	Remember On
Underline Cursor Off	75	4B	K	None	None	Remember On
Blinking Block Cursor On	83	53	S	None	None	Remember On
Blinking Block Cursor Off	84	54	T	None	None	Remember On



Table 19: Special Character Command Summary

Name	Dec	Hex	ASCII	Parameters	Response	Remembered
Create a Custom Character	78	4E	N	Byte[9]	None	Remember On
Save Custom Characters	193	C1	ñ	Byte[10]	None	Always
Load Custom Characters	192	C0		Byte	None	Never
Save Start Up Screen Custom Characters	194	C2		Byte[9]	None	Always
Initialize Medium Numbers	109	6D	m	None	None	Never
Place Medium Numbers	111	6F	o	Row, Col, Digit	None	Never
Initialize Horizontal Bar	104	68	h	None	None	Never
Place Horizontal Bar Graph	124	7C		Col, Row, Dir, Length	None	Never
Initialize Narrow Vertical Bar	115	73	s	None	None	Never
Initialize Wide Vertical Bar	118	76	v	None	None	Never
Place Vertical Bar	61	3D	=	Col, Length	None	Never

Table 20: General Purpose Output Command Summary

Name	Dec	Hex	ASCII	Parameters	Response	Remembered
4.2General Purpose Output Off	86	56	V	Byte	None	Never
General Purpose Output On	87	57	W	Byte	None	Never
Set Start Up GPO State	195	C3		Byte[2]	None	Always
Set LED Indicators	90	5A	Z	Byte[2]	None	Remember On

Table 21: Keypad Command Summary

Name	Dec	Hex	ASCII	Parameters	Response	Remembered
Auto Transmit Key Presses On	65	41	A	None	None	Remember On
Auto Transmit Key Presses Off	79	4F	`	None	None	Remember On
Poll Key Press	38	26	&	None	Byte	Never
Clear Key Buffer	69	45	E	None	None	Never
Set Debounce Time	85	55	U	Byte	None	Remember On
Set Auto Repeat Mode	126	7E	DEL	Mode	None	Remember On
Auto Repeat Mode Off	96	60	`	None	None	Remember On
Assign Keypad Codes	213	D5		Byte[4], Byte[4]	None	Always
Keypad Backlight Off	155	98		None	None	Never
Set Keypad Brightness	156	9C		Byte	None	Remember On
Set Auto Backlight	157	9D		Byte	None	Always



Table 22: Display Functions Command Summary

Name	Dec	Hex	ASCII	Parameters	Response	Remembered
Backlight On	66	42	B	Byte	None	Remember On
Backlight Off	70	46	F	None	None	Remember On
Set Brightness	153	99	Ö	Byte	None	Remember On
Set and Save Brightness	152	98	ÿ	Byte	None	Always
Set Backlight Colour	130	82	é	Byte[3]	None	Remember On
Set Contrast	80	50	P	Byte	None	Remember On
Set and Save Contrast	145	91	æ	Byte	None	Always

Table 23: Data Security Command Summary

Name	Dec	Hex	ASCII	Parameters	Response	Remembered
Set Remember	147	93	ô	Byte	None	Always
Set Data Lock	202, 245, 160	CA, F5, A0	Ĳ, Ĵ, á	Byte	None	Remember On
Set and Save Data Lock	203, 245, 160	CB, F5, A0	Ĳ, Ĵ, á	Byte	None	Always

Table 24: Miscellaneous Command Summary

Name	Dec	Hex	ASCII	Parameters	Response	Remembered
Write Customer Data	52	34	4	Byte[16]	None	Always
Read Customer Data	53	35	5	None	Byte[16]	Never
Read Version Number	54	36	6	None	Byte	Never
Read Module Type	55	37	7	None	Byte	Never



7.2 Character Sets

		Higher 4-bit (D4 to D7) of Character Code (Hexadecimal)																		
		0	1	2	3	4	5	6	7	8	9	A	B	C	D	E	F			
Lower 4-bit (D0 to D3) of Character Code (Hexadecimal)	0	CG RAM (1)	±		0	1	2	3	4	5	6	7	8	9	A	B	C	D	E	F
	1	CG RAM (2)	≡	!	1	A	Q	a	9	0	a	i		U	+	y	v			
	2	CG RAM (3)	7	"	2	B	R	b	r	e	R	o	°	o	9	o				
	3	CG RAM (4)	∟	⊛	3	O	S	s	8	a	o	'	7	7	e					
	4	CG RAM (5)	∟	⊛	4	D	T	t	a	b	c	'	+	7	z					
	5	CG RAM (6)	∟	∟	5	E	U	u	à	à	e	'	o	7	∟	∟				
	6	CG RAM (7)	∟	∟	6	F	V	v	à	o	∟	'	∟	∟	∟	∟				
	7	CG RAM (8)	∟	'	7	a	w	w	s	o	r	x	x	∟	∟	∟				
	8	CG RAM (1)	∟	∟	8	H	X	x	e	e	'	'	∟	∟	∟	∟				
	9	CG RAM (2)	∟	∟	9	I	Y	y	e	e	i	∟	∟	∟	∟	∟				
	A	CG RAM (3)	∟	∟	A	J	Z	z	e	o	∟	∟	∟	∟	∟	∟				
	B	CG RAM (4)	∟	∟	B	K	C	c	i	a	∟	∟	∟	∟	∟	∟				
	C	CG RAM (5)	∟	∟	C	L	V	v	i	∟	∟	∟	∟	∟	∟	∟				
	D	CG RAM (6)	∟	∟	D	M	N	n	i	∟	∟	∟	∟	∟	∟	∟				
	E	CG RAM (7)	∟	∟	E	.	>	N	∟	∟	∟	∟	∟	∟	∟	∟				
	F	CG RAM (8)	∟	∟	F	∟	∟	∟	∟	∟	∟	∟	∟	∟	∟	∟				

Figure 12: LCD Model European Character Set



7.3 Block Diagram

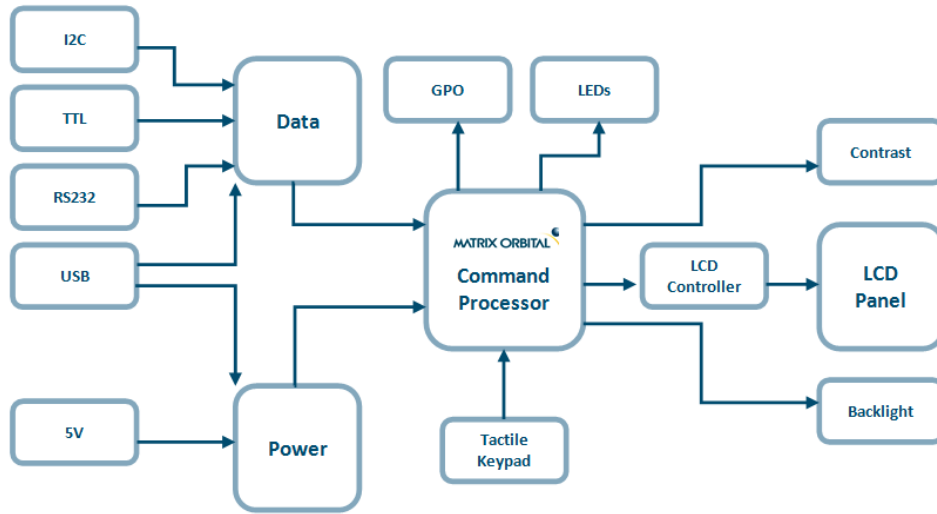

Figure 13: Functional Diagram

7.4 Environmental Specifications

Table 25: Environmental Limits

	Standard	Extended (-E)
Operating Temperature	0°C to +50°C	-20°C to +70°C
Storage Temperature	-10°C to +60°C	-30°C to +80°C
Operating Relative Humidity	Maximum 90% non-condensing	
Thermal Shock	Maximum 10°C /min	

7.5 Electrical Tolerances

Current Consumption

Table 26: Current Consumption

Board	+	Backlight	+	Keypad Backlight	+	BiColour LEDs	+	GPOs
50mA		25 to 35 mA		20 mA		2(Red) to 20(Grn) mA		20mA each (max)

Table 27: Backlight Current Draw

YG & FGW & WB	TCI
25mA	35mA

Input Voltage Specifications

Table 28: Voltage Specifications

Standard
4.75-5.25V



7.6 Dimensional Drawings

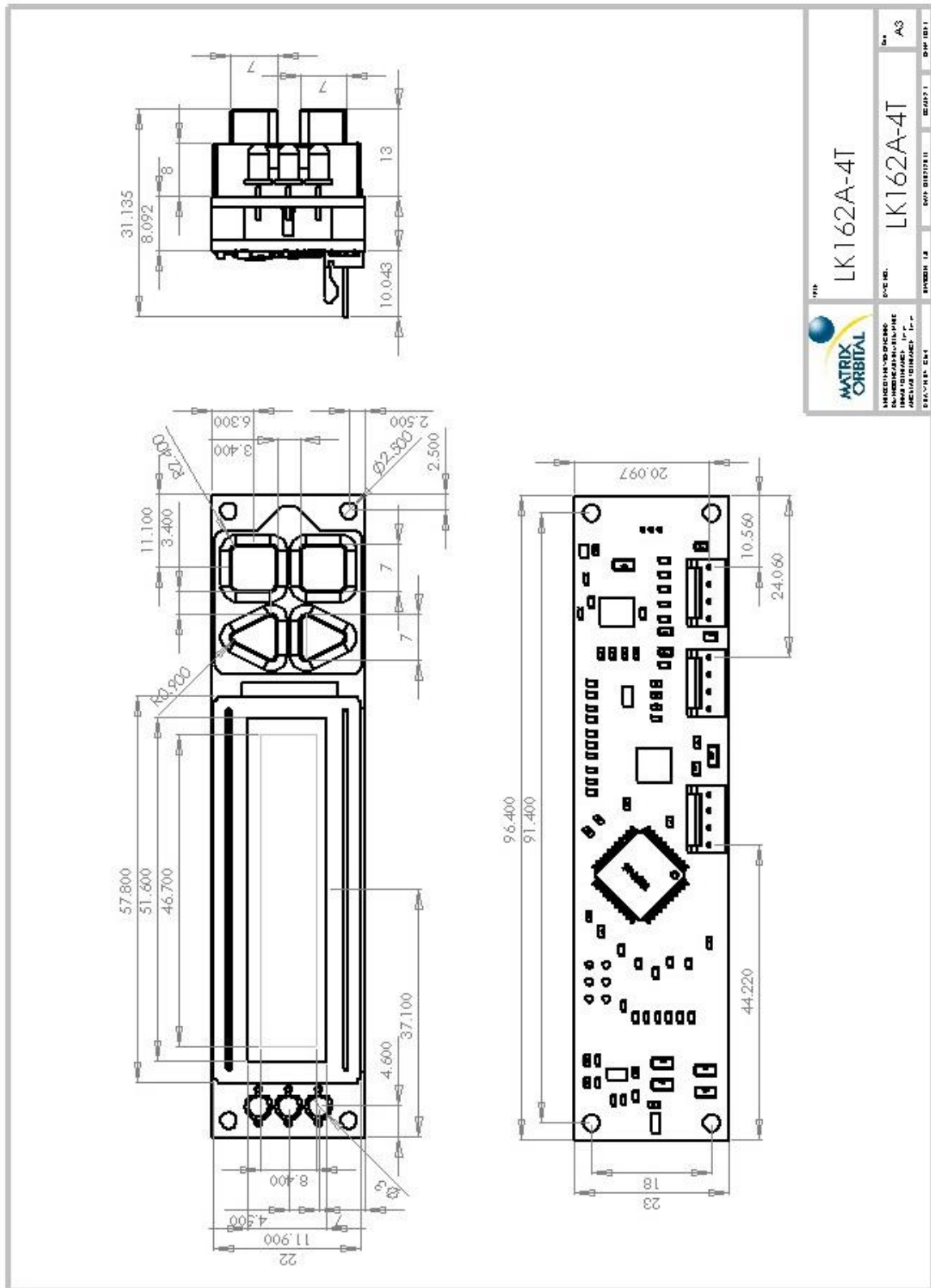

Figure 14: LK162A-4T Dimensional Drawing



7.7 Optical Characteristics

Table 29: Display Optics

Module Size	96.40 x 23.00 x 31.14	mm
Viewing Area	51.6 x 11.9	mm
Active Area	48.2 x 8.9	mm
Character Size	2.45 x 3.95	mm
Character Pitch	3.05 x 4.95	mm
Pixel Size	0.45 x 0.45	mm
Pixel Pitch	0.50 x 0.50	mm
Viewing Direction	12	O'clock
Viewing Angle	-30 to +30	°
Contrast Ratio	3	
Backlight Half-Life	50,000*	Hours

*Note: Operation above 40°C and/or 50% RH will decrease half-life.

8 Ordering

8.1 Part Numbering Scheme

Table 30: Part Numbering Scheme

LK	-162	A	-4T	-USB	-WB	-E
1	2	3	4	5	6	7

8.2 Options

Table 31: Display Options

#	Designator	Options
1	Product Type	LK: Liquid Crystal Display with Keypad Input
2	Display Size	-162: 16 columns by 2 rows
3	Form Factor	A: A form factor
4	Keypad Size	-4T: Four Integrated Tactile Keys
5	Protocol	*NP: Standard Model -USB: USB Only Model
6	Colour	*NP: Standard (Grey Text with Yellow-Green Background) -FGW: Grey Text with White Background -WB: White Text with Blue Background -TCI: Tricolour Text with Black Background
7	Temperature	*NP: Standard -E: Extended Temperature



*Note: NP means No Populate; skip this designator in the part number and move to the next option.



8.3 Accessories

Communication

Table 32: Communication Accessories

CBL-USBA24PIN3FT	Four Pin USB Cable	
SCCPC5V	Serial Communication/5V Power Cable	
BBC	Breadboard Cable	

Mounting

Table 33: Mounting Accessories

B1624T-BK	Black 4T Mounting Bracket	
-----------	---------------------------	---



9 Definitions

ASCII: American standard code for information interchange used to give standardized numeric codes to alphanumeric characters.

BPS: Bits per second, a measure of transmission speed.

FFSTN: Double film super-twisted nematic in reference to an LCD. The addition of two layers of film between the STN display and polarizer improves contrast.

GPO: General purpose output, used to control peripheral devices from a display.

GUI: Graphical user interface.

Hexadecimal: A base 16 number system utilizing symbols 0 through F to represent the values 0-15.

I²C: Inter-integrated circuit protocol uses clock and data lines to communicate short distances at slow speeds from a master to up to 128 addressable slave devices. A display is a slave device.

LSB: Least significant bit or byte in a transmission, the rightmost when read.

MSB: Most significant bit or byte in a transmission, the leftmost when read.

RS232: Recommended standard 232, a common serial protocol. A low level is -30V, a high is +30V.

SDA: Serial data line used to transfer data in I²C protocol. This open drain line should be pulled high through a resistor. Nominal values are between 1K and 10K Ω .

SCL: Serial clock line used to designate data bits in I²C protocol. This open drain line should be pulled high through a resistor. Nominal values are between 1K and 10K Ω .

STN: Super-twisted nematic in reference to an LCD. In a relaxed or nematic state, crystals orientate themselves in the same direction and allow light to pass. In an excited state these crystals align to block light. Super-twisted crystals move from 180 to 270 degrees providing greater contrast than TN models.

TTL: Transistor-transistor logic applied to serial protocol. Low level is 0V while high logic is 5V.

10 Contact

Sales

Phone: 403.229.2737

Email: sales@matrixorbital.ca

Support

Phone: 403.204.3750

Email: support@matrixorbital.ca

Online

Purchasing: www.matrixorbital.com

Support: www.matrixorbital.ca

