



Main

Range of product	OsiSense XU
Series name	Application
Electronic sensor type	Photo-electric sensor
Sensor name	XUY
Sensor design	Fork
Detection system	Thru beam
Emission	Infrared laser, modulated (class 1) conforming to IEC 825-1
Passage width	1.18 in (30 mm)
Passage depth	1.65 in (42 mm)
Material	Metal/plastic
Supply circuit type	DC
Wiring technique	4-wire
Discrete output type	PNP and NPN
Discrete output function	1 NO or 1 NC programmable
Electrical connection	1 male connector M8, 4 pins
Product specific application	Detection of reference marks Detection of transparent object Detection on vibrating rail Detection on small conveyor
[Sn] nominal sensing distance	1.18 in (30 mm)

Complementary

Enclosure material	Painted aluminium and polyamide/glass
Keypad type	Green
Minimum object diameter for detection	0 in (0.05 mm)
Type of output signal	Discrete
Output type	Solid state
Status LED	1 LED (red) adjustment mode and keypad locking 1 LED (yellow) output state
[Us] rated supply voltage	12...24 V DC with reverse polarity protection
Supply voltage limits	10...30 V DC
Switching capacity in mA	100 mA (overload and short-circuit protection)
Switching frequency	10 kHz
Voltage drop	< 2 V (closed state)
Current consumption	40 mA (no-load)
Load capacitance	330 nF
Time response	-20...20 µs
Setting-up	Sensitivity by numeric potentiometer
Product weight	0.42 lb(US) (0.19 kg)

Environment

product certifications	CE CULus
ambient air temperature for operation	-4...140 °F (-20...60 °C)
ambient air temperature for storage	-22...176 °F (-30...80 °C)
immunity to ambient light	10000 lux with natural light 5000 lux with incandescent bulb
vibration resistance	7 gn, amplitude = +/- 0.75 mm (f = 10...55 Hz) conforming to IEC 60068-2-6
shock resistance	30 gn (duration = 11 ms) conforming to IEC 60068-2-27

Offer Sustainability

Not Green Premium product

Not Green Premium product

Compliant - since 0727 - Schneider Electric declaration of conformity

Compliant - since 0727 - Schneider Electric declaration of conformity

WARNING: This product can expose you to chemicals including:

WARNING: This product can expose you to chemicals including:

Diisononyl phthalate (DINP), which is known to the State of California to cause cancer, and

Diisononyl phthalate (DINP), which is known to the State of California to cause cancer, and

Di-isodecyl phthalate (DIDP), which is known to the State of California to cause birth defects or other reproductive harm.

Di-isodecyl phthalate (DIDP), which is known to the State of California to cause birth defects or other reproductive harm.

For more information go to www.p65warnings.ca.gov

For more information go to www.p65warnings.ca.gov

Contractual warranty

Warranty period

18 months

Dimensions

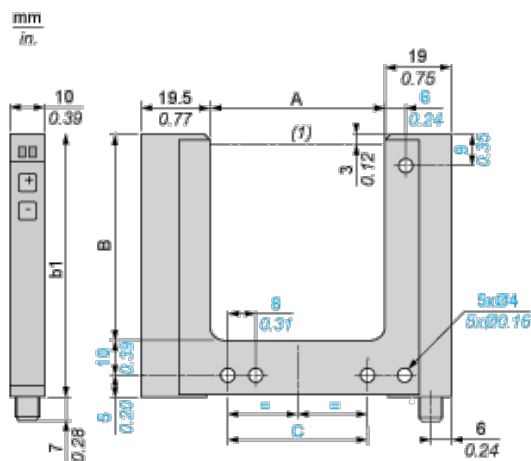

(1) Optical axis

Dimensions in mm

A	B	b1	C
30	42	57	42

Dimensions in in.

A	B	b1	C
1.18	1.65	2.24	1.65

Wiring Schemes

M8 Connector

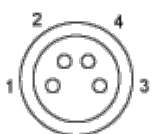

- 1 : BN: Brown
- 2 : WH: White
- 3 : BU: Blue
- 4 : BK: Black

4-Wire, PNP/NPN Outputs



BN : Brown

WH :White

BK : Black

BU : Blue