

Part Number: APL3015EC-F01

High Efficiency Red

### Features

- 3.0mmx1.5mm SMT LED, 1.4mm thickness.
- Low power consumption.
- Ideal for backlight and indicator.
- Various colors and lens types available.
- Package : 2000pcs / reel.
- Moisture sensitivity level : level 3.
- RoHS compliant.

### Description

The High Efficiency Red source color devices are made with Gallium Arsenide Phosphide on Gallium Phosphide Orange Light Emitting Diode.

### Package Dimensions

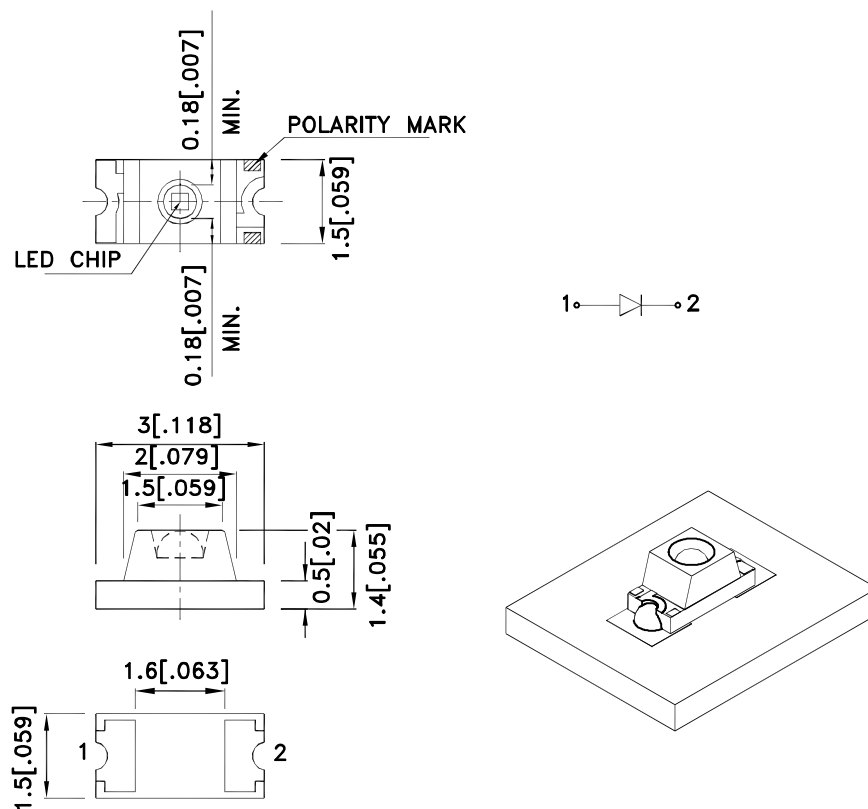

#### Notes:

1. All dimensions are in millimeters (inches).
2. Tolerance is  $\pm 0.2$  (0.008") unless otherwise noted.
3. The specifications, characteristics and technical data described in the datasheet are subject to change without prior notice.
4. The device has a single mounting surface. The device must be mounted according to the specifications.



## Selection Guide

| Part No.      | Dice                            | Lens Type   | Iv (mcd) [2]<br>@ 20mA |      | Viewing<br>Angle [1] |
|---------------|---------------------------------|-------------|------------------------|------|----------------------|
|               |                                 |             | Min.                   | Typ. | 2θ1/2                |
| APL3015EC-F01 | High Efficiency Red (GaAsP/GaP) | Water Clear | 12                     | 25   | 70°                  |

Notes:

1. θ1/2 is the angle from optical centerline where the luminous intensity is 1/2 of the optical peak value.
2. Luminous intensity/ luminous Flux: +/-15%.

## Electrical / Optical Characteristics at TA=25°C

| Symbol             | Parameter                | Device              | Typ. | Max. | Units | Test Conditions           |
|--------------------|--------------------------|---------------------|------|------|-------|---------------------------|
| λ <sub>peak</sub>  | Peak Wavelength          | High Efficiency Red | 627  |      | nm    | I <sub>F</sub> =20mA      |
| λ <sub>D</sub> [1] | Dominant Wavelength      | High Efficiency Red | 625  |      | nm    | I <sub>F</sub> =20mA      |
| Δλ <sub>1/2</sub>  | Spectral Line Half-width | High Efficiency Red | 45   |      | nm    | I <sub>F</sub> =20mA      |
| C                  | Capacitance              | High Efficiency Red | 15   |      | pF    | V <sub>F</sub> =0V;f=1MHz |
| V <sub>F</sub> [2] | Forward Voltage          | High Efficiency Red | 2    | 2.5  | V     | I <sub>F</sub> =20mA      |
| I <sub>R</sub>     | Reverse Current          | High Efficiency Red |      | 10   | uA    | V <sub>R</sub> =5V        |

Notes:

- 1.Wavelength: +/-1nm.
2. Forward Voltage: +/-0.1V.

## Absolute Maximum Ratings at TA=25°C

| Parameter                | High Efficiency Red | Units |
|--------------------------|---------------------|-------|
| Power dissipation        | 75                  | mW    |
| DC Forward Current       | 30                  | mA    |
| Peak Forward Current [1] | 160                 | mA    |
| Reverse Voltage          | 5                   | V     |
| Operating Temperature    | -40°C To +85°C      |       |
| Storage Temperature      | -40°C To +85°C      |       |

Note:

1. 1/10 Duty Cycle, 0.1ms Pulse Width.

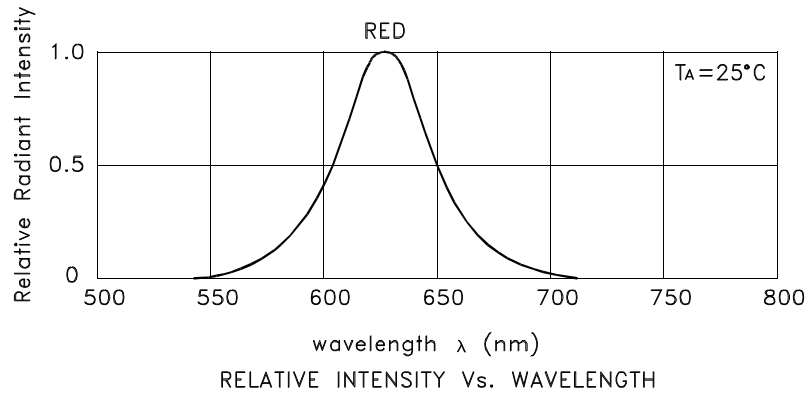

## High Efficiency Red APL3015EC-F01

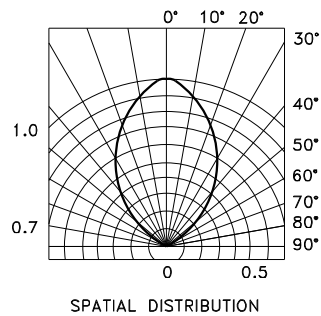
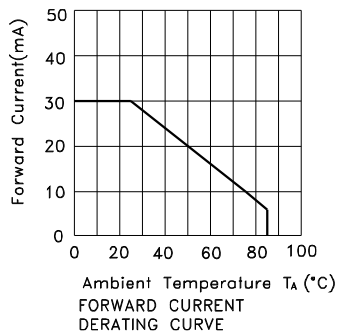

## APL3015EC-F01

Reflow soldering is recommended and the soldering profile is shown below.  
Other soldering methods are not recommended as they might cause damage to the product.

Reflow Soldering Profile For Lead-free SMT Process.



NOTES:

1. We recommend the reflow temperature 245°C(+/-5°C). The maximum soldering temperature should be limited to 260°C.
2. Don't cause stress to the epoxy resin while it is exposed to high temperature.
3. Number of reflow process shall be 2 times or less.

### Recommended Soldering Pattern (Units : mm; Tolerance: ± 0.1)

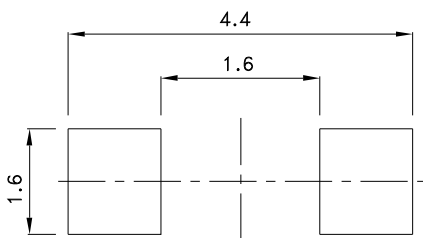

### Reel Dimension



### Tape Dimensions (Units : mm)

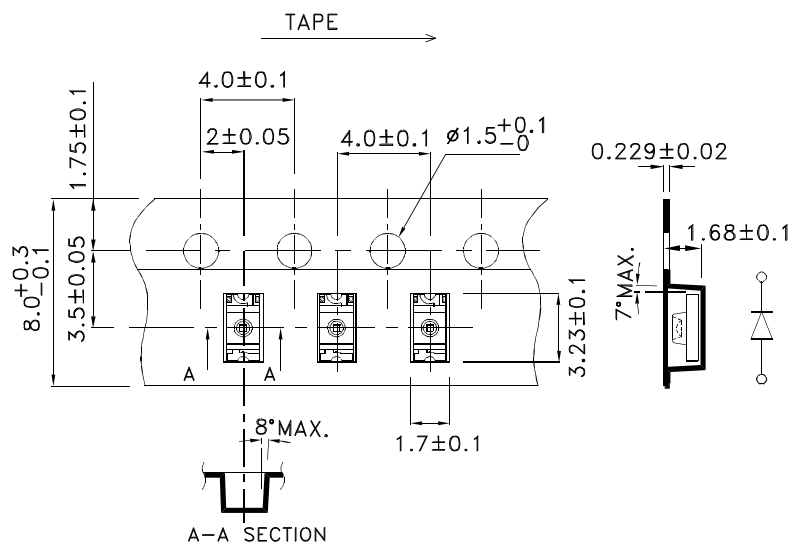

# Kingbright

PACKING & LABEL SPECIFICATIONS

APL3015EC-F01



|   |  |
|---|--|
| <b>Kingbright</b>   |  |
| P/NO: APL3015xxx  |  |
| QTY: 2,000 pcs  | Q.C. <span style="border: 1px solid black; border-radius: 50%; padding: 2px;">Q C<br/>xx xx xxxx<br/>PASSED</span> |
| S/N: XXXX   |  |
| CODE: XXX   |  |
| LOT NO:   |  |
| <br><small>xxxxxxxxxxxxxxxxxxxxxxxxxxxxxxxx</small> |  |
| RoHS Compliant  |  |