



Is Now Part of



**ON Semiconductor®**

To learn more about ON Semiconductor, please visit our website at  
[www.onsemi.com](http://www.onsemi.com)

Please note: As part of the Fairchild Semiconductor integration, some of the Fairchild orderable part numbers will need to change in order to meet ON Semiconductor's system requirements. Since the ON Semiconductor product management systems do not have the ability to manage part nomenclature that utilizes an underscore (\_), the underscore (\_) in the Fairchild part numbers will be changed to a dash (-). This document may contain device numbers with an underscore (\_). Please check the ON Semiconductor website to verify the updated device numbers. The most current and up-to-date ordering information can be found at [www.onsemi.com](http://www.onsemi.com). Please email any questions regarding the system integration to [Fairchild\\_questions@onsemi.com](mailto:Fairchild_questions@onsemi.com).

ON Semiconductor and the ON Semiconductor logo are trademarks of Semiconductor Components Industries, LLC dba ON Semiconductor or its subsidiaries in the United States and/or other countries. ON Semiconductor owns the rights to a number of patents, trademarks, copyrights, trade secrets, and other intellectual property. A listing of ON Semiconductor's product/patent coverage may be accessed at [www.onsemi.com/site/pdf/Patent-Marking.pdf](http://www.onsemi.com/site/pdf/Patent-Marking.pdf). ON Semiconductor reserves the right to make changes without further notice to any products herein. ON Semiconductor makes no warranty, representation or guarantee regarding the suitability of its products for any particular purpose, nor does ON Semiconductor assume any liability arising out of the application or use of any product or circuit, and specifically disclaims any and all liability, including without limitation special, consequential or incidental damages. Buyer is responsible for its products and applications using ON Semiconductor products, including compliance with all laws, regulations and safety requirements or standards, regardless of any support or applications information provided by ON Semiconductor. "Typical" parameters which may be provided in ON Semiconductor data sheets and/or specifications can and do vary in different applications and actual performance may vary over time. All operating parameters, including "Typicals" must be validated for each customer application by customer's technical experts. ON Semiconductor does not convey any license under its patent rights nor the rights of others. ON Semiconductor products are not designed, intended, or authorized for use as a critical component in life support systems or any FDA Class 3 medical devices or medical devices with a same or similar classification in a foreign jurisdiction or any devices intended for implantation in the human body. Should Buyer purchase or use ON Semiconductor products for any such unintended or unauthorized application, Buyer shall indemnify and hold ON Semiconductor and its officers, employees, subsidiaries, affiliates, and distributors harmless against all claims, costs, damages, and expenses, and reasonable attorney fees arising out of, directly or indirectly, any claim of personal injury or death associated with such unintended or unauthorized use, even if such claim alleges that ON Semiconductor was negligent regarding the design or manufacture of the part. ON Semiconductor is an Equal Opportunity/Affirmative Action Employer. This literature is subject to all applicable copyright laws and is not for resale in any manner.



# FPF1015/6/7/8 IntelliMAX™ 1V Rated Advanced Load Management Products

## Features

- 0.8 to 1.8V Input Voltage Range
- Typical  $R_{DS(ON)} = 34m\Omega @ V_{ON} - V_{IN} = 2.0V$
- Output Discharge Function
- Internal Pull down at ON Pin
- Accurate Slew Rate Controlled Turn-on time
- Low < 1µA Quiescent Current
- ESD Protected, above 8000V HBM, 2000V CDM
- RoHS Compliant
- Free from Halogenated Compounds and Antimony Oxides

## General Description

The FPF1015/6/7/8 series is an IntelliMAX advanced slew rate loadswitch offering a very low operating voltage. These devices consist of a 34mΩ N-channel MOSFET that supports an input voltage up to 2.0V. These slew rate devices control the switch turn-on and prevent excessive in-rush current from the supply rails. The input voltage range operates from 0.8V to 1.8V to fulfill today's lowest Ultraportable Device's supply requirements. Switch control is via a logic input (ON) capable of interfacing directly with low voltage control signals.

The FPF1016 and FPF1018 have an On-Chip pull down allowing for quick and controlled output discharge when switch is turned off. The FPF1015/6/7/8 series is available in a space-saving 2X2 MLP-6L package.

## Applications

- PDAs
- Cell Phones
- GPS Devices
- MP3 Players
- Digital Cameras
- Notebook Computers



## Typical Application Circuit

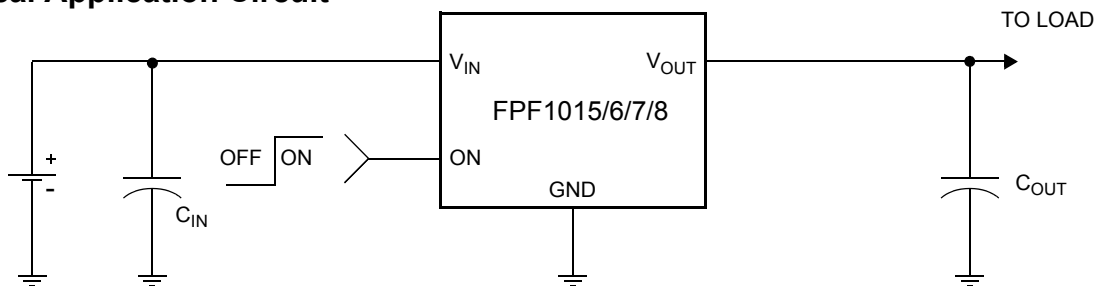

## Ordering Information

Part	Switch	Turn-on Time	Output Discharge	ON Pin Activity	Package
FPF1015	34mΩ, NMOS	43us	NA	Active HI	MLP 2x2
FPF1016	34mΩ, NMOS	43us	60Ω	Active HI	MLP 2x2
FPF1017	34mΩ, NMOS	165us	NA	Active HI	MLP 2x2
FPF1018	34mΩ, NMOS	165us	60Ω	Active HI	MLP 2x2

### Functional Block Diagram

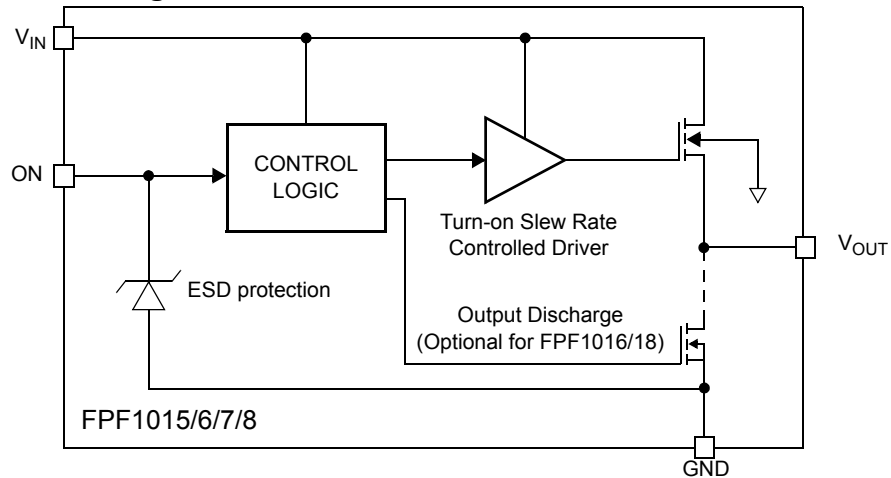

### Pin Configuration

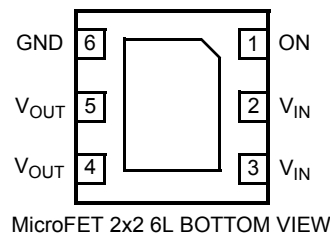

### Pin Description

Pin	Name	Function
1	ON	ON/OFF Control Input, 2nd Supply
2, 3	$V_{IN}$	Supply Input: Input to the power switch
4, 5	$V_{OUT}$	Switch Output.
6	GND	Ground

### Absolute Maximum Ratings

Parameter	Min	Max	Unit
$V_{IN}$ , $V_{OUT}$ to GND	-0.3	2	V
$V_{ON}$ to GND	-0.3	4.2	V
Maximum Continuous Switch Current		1.5	A
Power Dissipation @ $T_A = 25^\circ\text{C}$ (Note 1)		1.2	W
Operating Temperature Range	-40	85	$^\circ\text{C}$
Storage Temperature	-65	150	$^\circ\text{C}$
Thermal Resistance, Junction to Ambient		86	$^\circ\text{C/W}$
Electrostatic Discharge Protection	HBM	8000	V
	CDM	2000	V

### Recommended Operating Range

Parameter	Min	Max	Unit
$V_{IN}$	0.8	1.8	V
Ambient Operating Temperature, $T_A$	-40	85	$^\circ\text{C}$

**Note 1:** Package power dissipation on 1square inch pad, 2 oz. copper board

## Electrical Characteristics

$V_{IN} = 0.8$  to  $1.8V$ ,  $T_A = -40$  to  $+85^{\circ}C$  unless otherwise noted. Typical values are at  $V_{IN} = 1.8V$  and  $T_A = 25^{\circ}C$ .

Parameter	Symbol	Conditions	Min	Typ	Max	Unit
<b>Basic Operation</b>						
Operating Voltage	$V_{IN}$		0.8		1.8	V
ON input Voltage	$V_{ON(MIN)}$	$V_{IN} = 0.8V$	1.8	2.8	4.0	V
	$V_{ON(MAX)}$	$V_{IN} = 1.8V$ (Note2)	2.8	3.8	4.0	V
Operating Current	$I_{CC}$	$V_{IN} = 1V$ , $V_{ON} = 3.3V$ , $V_{OUT} = \text{Open}$			1	$\mu A$
Quiescent Current	$I_Q$	$V_{IN} = 1V$ , $V_{ON} = V_{OUT} = \text{Open}$			2	$\mu A$
Off Switch Current	$I_{SWOFF}$	$V_{IN} = 1.8V$ , $V_{ON} = \text{GND}$ , $V_{OUT} = \text{GND}$			2	$\mu A$
On-Resistance	$R_{ON}$	$V_{IN} = 1V$ , $V_{ON} = 3V$ , $I_{LOAD} = 1A$ , $T_A = 25^{\circ}C$		34	45	m $\Omega$
		$V_{IN} = 1V$ , $V_{ON} = 2.3V$ , $I_{LOAD} = 1A$ , $T_A = 25^{\circ}C$		41	55	
Output Pull Down Resistance	$R_{PD}$	$V_{IN} = 1V$ , $V_{ON} = 0V$ , $T_A = 25^{\circ}C$ , $I_{LOAD} = 1mA$ , FPF1016, FPF1018		60	120	$\Omega$
ON Input Logic Low Voltage	$V_{IL}$	$V_{IN} = 0.8V$ , $R_{LOAD} = 1K\Omega$			0.3	V
		$V_{IN} = 1.8V$ , $R_{LOAD} = 1K\Omega$			0.8	
ON Input Leakage		$V_{ON} = V_{IN}$ or GND	-1		1	$\mu A$
<b>Dynamic (<math>V_{IN} = 1.0V</math>, <math>V_{ON} = 3.0V</math>, <math>T_A = 25^{\circ}C</math>)</b>						
$V_{OUT}$ Rise Time	$T_R$	FPF1015, FPF1016, $R_L = 500\Omega$ , $C_L = 0.1\mu F$		28		$\mu s$
		FPF1017, FPF1018, $R_L = 500\Omega$ , $C_L = 0.1\mu F$		114		
		FPF1015, FPF1016, $R_L = 3.3\Omega$ , $C_L = 10\mu F$		38		
		FPF1017, FPF1018, $R_L = 3.3\Omega$ , $C_L = 10\mu F$		155		
Turn ON	$T_{ON}$	FPF1015, FPF1016, $R_L = 500\Omega$ , $C_L = 0.1\mu F$		43		$\mu s$
		FPF1017, FPF1018, $R_L = 500\Omega$ , $C_L = 0.1\mu F$		165		
		FPF1015, FPF1016, $R_L = 3.3\Omega$ , $C_L = 10\mu F$		58		
		FPF1017, FPF1018, $R_L = 3.3\Omega$ , $C_L = 10\mu F$		228		
$V_{OUT}$ Fall Time	$T_F$	FPF1015, FPF1017, $R_L = 500\Omega$ , $C_L = 0.1\mu F$		105		$\mu s$
		FPF1016, FPF1018, $R_{PD} = 60\Omega$ , $R_L = 500\Omega$ , $C_L = 0.1\mu F$		15		
		FPF1015, FPF1017, $R_L = 3.3\Omega$ , $C_L = 10\mu F$		80		
		FPF1016, FPF1018, $R_{PD} = 60\Omega$ , $R_L = 3.3\Omega$ , $C_L = 10\mu F$		74		
Turn Off	$T_{OFF}$	FPF1015, FPF1017, $R_L = 500\Omega$ , $C_L = 0.1\mu F$		150		$\mu s$
		FPF1016, FPF1018, $R_{PD} = 60\Omega$ , $R_L = 500\Omega$ , $C_L = 0.1\mu F$		53		
		FPF1015, FPF1017, $R_L = 3.3\Omega$ , $C_L = 10\mu F$		102		
		FPF1016, FPF1018, $R_{PD} = 60\Omega$ , $R_L = 3.3\Omega$ , $C_L = 10\mu F$		96		

**Note 2:**  $V_{ON(MAX)}$  is limited by the absolute rating.

## Typical Characteristics

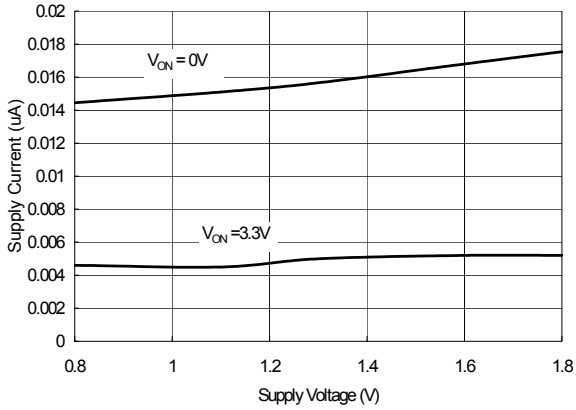

Figure 1. Supply Current vs.  $V_{IN}$

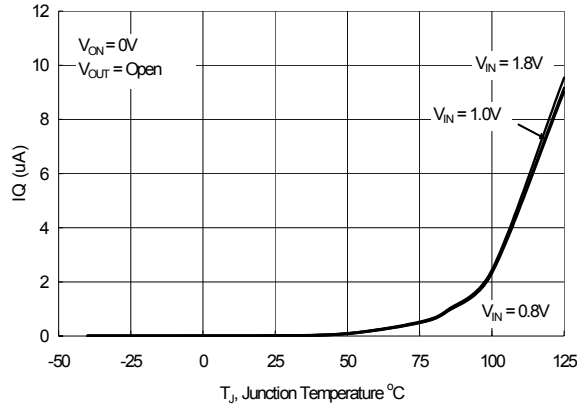

Figure 2. Quiescent Current vs. Temperature

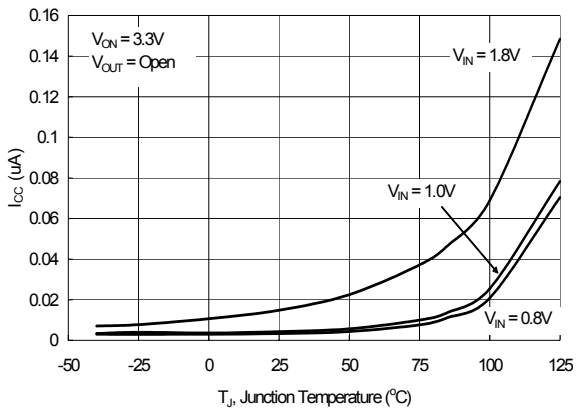

Figure 3. Operating Current vs. Temperature

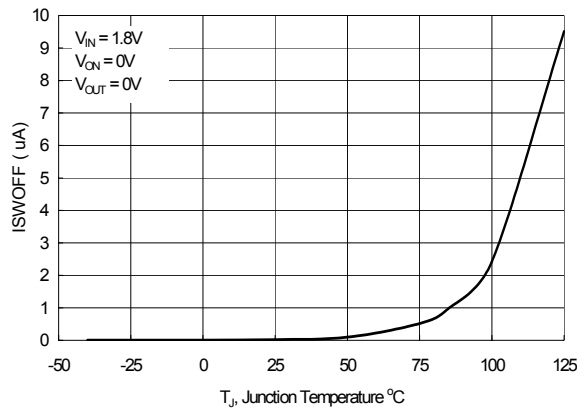

Figure 4. Off Switch Current vs. Temperature

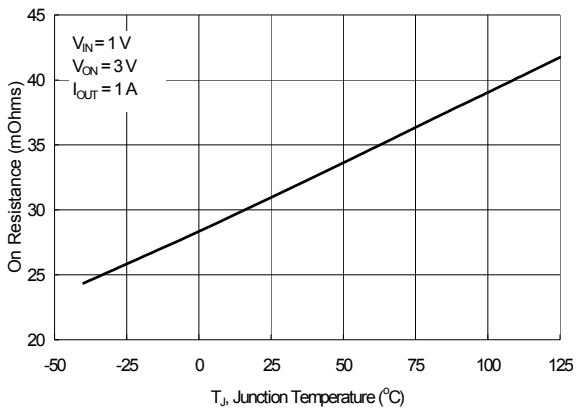

Figure 5.  $R_{ON}$  vs. Temperature

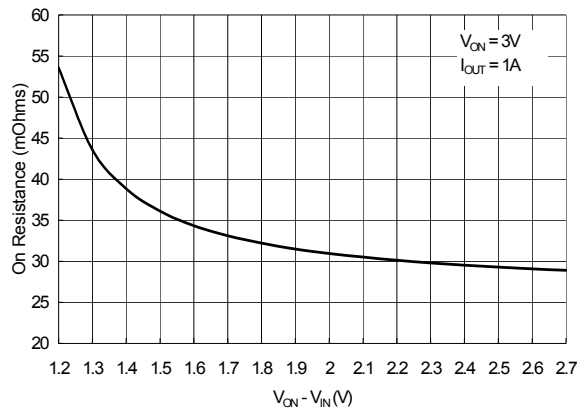

Figure 6.  $R_{ON}$  vs.  $V_{ON} - V_{IN}$

## Typical Characteristics

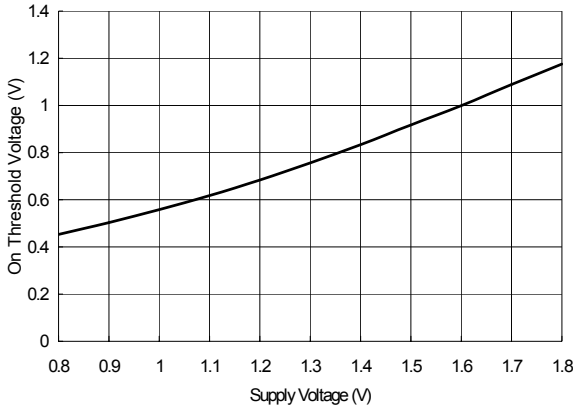

Figure 7.  $V_{IL}$  vs.  $V_{IN}$

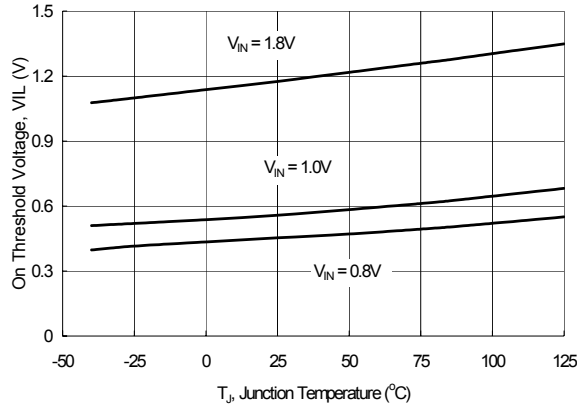

Figure 8.  $V_{IL}$  vs. Temperature

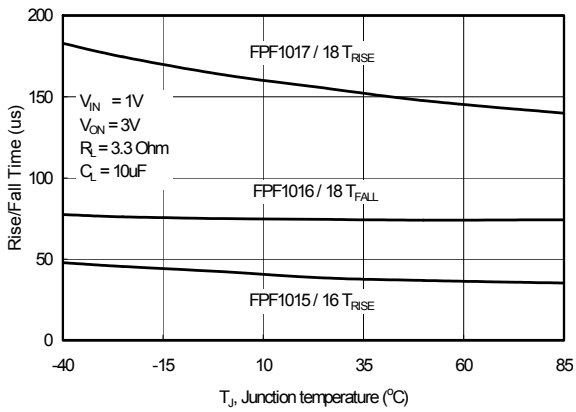

Figure 9.  $T_{RISE}/T_{FALL}$  vs. Temperature

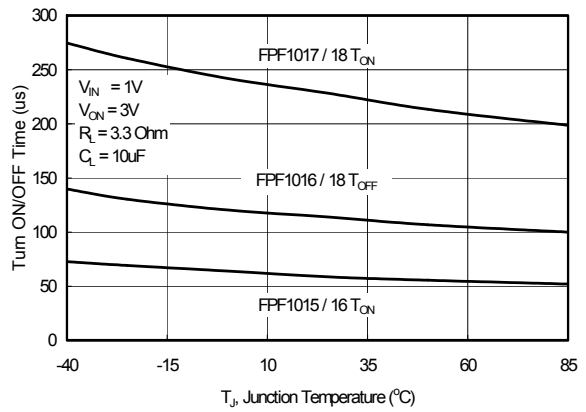

Figure 10.  $T_{ON}/T_{OFF}$  vs. Temperature

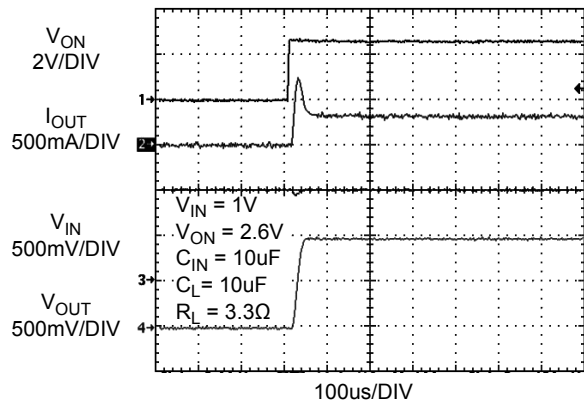

Figure 11. FPF1015 / 16 Turn ON response

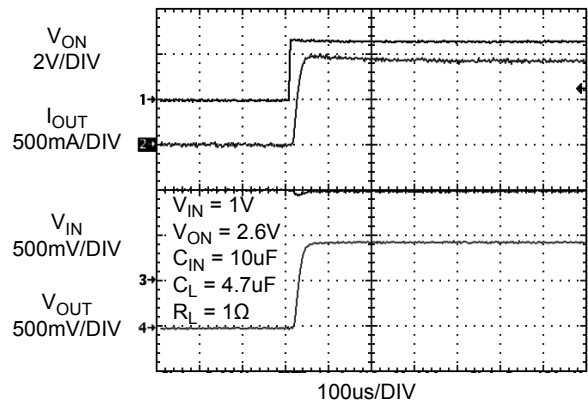

Figure 12. FPF1015 / 16 Turn ON response

## Typical Characteristics

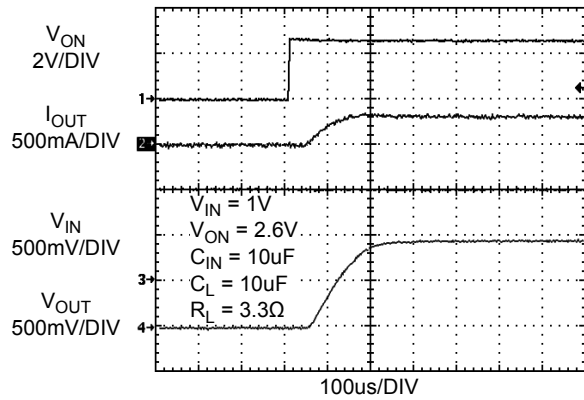

Figure 13. FPF1017 / 18 Turn On response

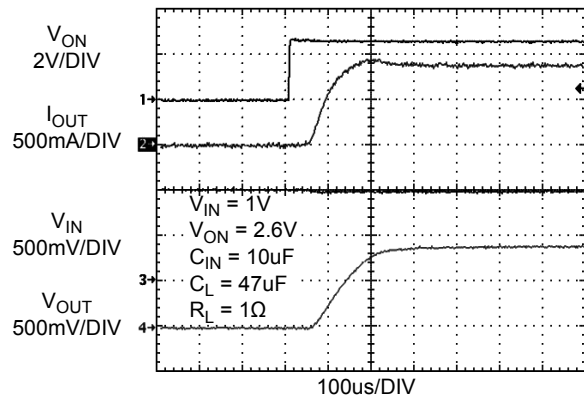

Figure 14. FPF1017 / 18 Turn On response

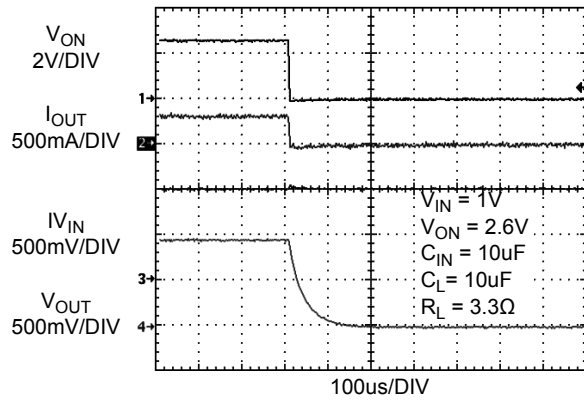

Figure 15. FPF1015 / 17 Turn OFF response

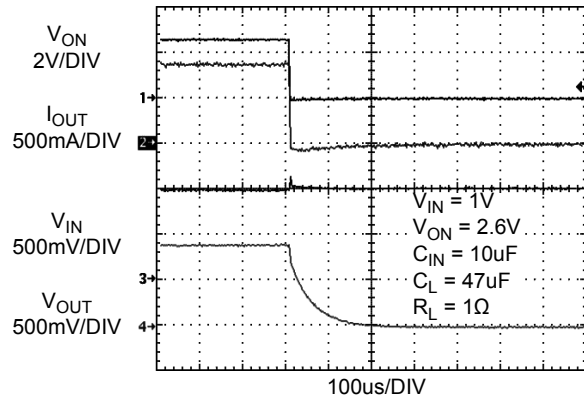

Figure 16. FPF1015 / 17 Turn OFF response

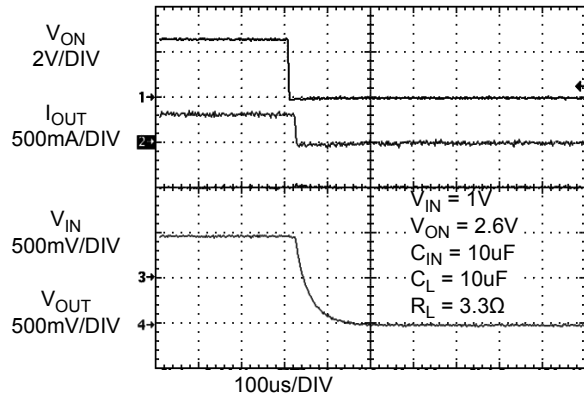

Figure 17. FPF1016 / 18 Turn OFF response

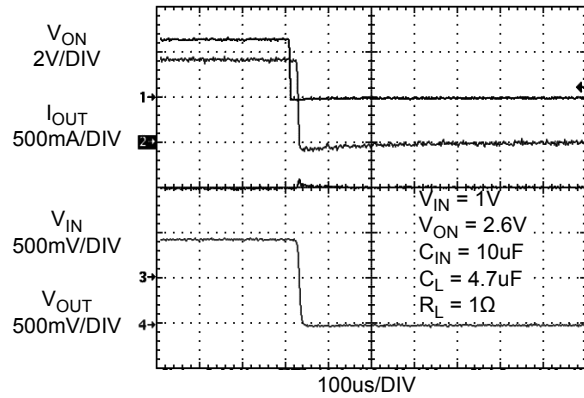

Figure 18. FPF1016 / 18 Turn OFF response

### Typical Characteristics

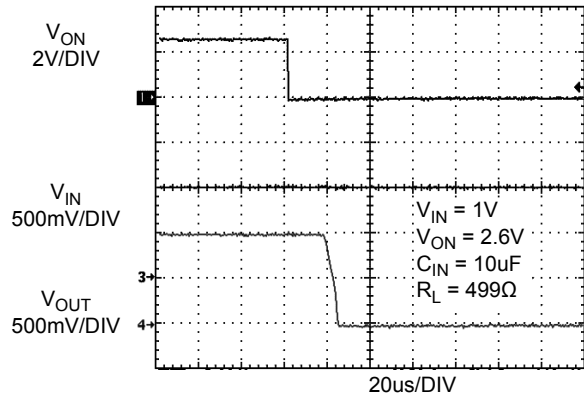

Figure 19. FPF1016 / 18 Output Pull Down response



## Description of Operation

The FPF1015/6/7/8 are low  $R_{DS(ON)}$  N-Channel load switches with controlled turn-on. The core of each device is a 34mΩ ( $V_{IN} = 1V$ ,  $V_{ON} = 3V$ ) N-Channel MOSFET and is customized for a low input operating range of 0.8 to 1.8V. The ON pin controls the state of the switch.

The FPF1016 and FPF1018 contain a 60Ω(typ) on-chip resistor which is connected internally from  $V_{OUT}$  to GND for quick output discharge when the switch is turned off.

## On/Off Control

The ON pin is active high and it controls the state of the switch. Applying a continuous high signal will hold the switch in the ON state. In order to minimize the switch on resistance, the ON pin voltage should exceed the input voltage by 2V. This device is compatible with a GPIO (General Purpose Input/Output) port, where the logic voltage level can be configured to  $4V \geq V_{ON} \geq V_{IN} + 2V$  and power consumed is less than 1μA in steady state.

## Application Information

### Typical Application

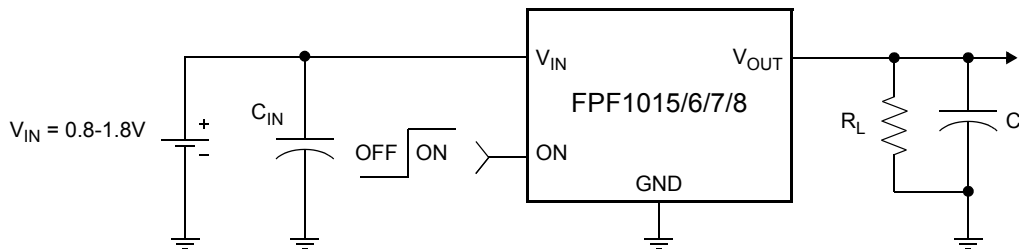

### Input Capacitor

To limit the voltage drop on the input supply caused by transient in-rush currents when the switch turns-on, a capacitor must be placed between  $V_{IN}$  and GND. For minimized voltage drop, especially when the operating voltage approaches 1V and a fast slew rate part (FPF1015 and FPF1016) is selected, a 10μF ceramic capacitor should be placed close to the  $V_{IN}$  pins. Higher values of  $C_{IN}$  can be used to further reduce the voltage drop during higher current modes of operation.

### Output Capacitor

A 0.1μF capacitor,  $C_L$ , should be placed between  $V_{OUT}$  and GND. This capacitor will prevent parasitic board inductance from forcing  $V_{OUT}$  below GND when the switch turns-off. If the application has a capacitive load, the FPF1016 and FPF1018 can be used to discharged that load through an on-chip output discharge path.

## Timing Diagram

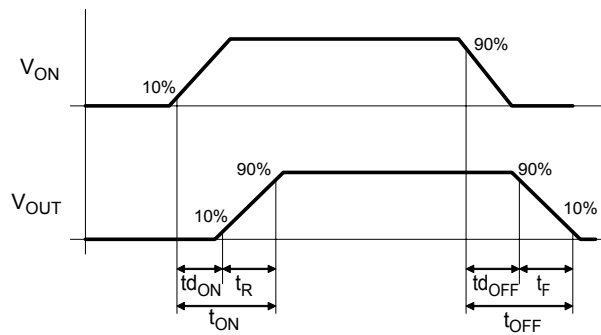

where:

- $t_{dON}$  = Delay On Time
- $t_R$  =  $V_{OUT}$  Rise Time
- $t_{ON}$  = Turn On Time
- $t_{dOFF}$  = Delay Off Time
- $t_F$  =  $V_{OUT}$  Fall Time
- $t_{OFF}$  = Turn Off Time

### Board Layout

For best performance, all traces should be as short as possible. To be most effective, the input and output capacitors should be placed close to the device to minimize the effects that parasitic trace inductances may have on normal and short-circuit operation. Using wide traces or large copper planes for all pins ( $V_{IN}$ ,  $V_{OUT}$ , ON and GND) will help minimize the parasitic electrical effects along with minimizing the case to ambient thermal impedance.

### Improving Thermal Performance

An improper layout could result in higher junction temperature. This concern applies when the current is at its continuous maximum value and is then switched into a large capacitive load that introduces a large transient current. Since the FPF1015/6/7/8 does not have thermal shutdown capability, a proper layout is essential to improving power dissipation of the switch in transient events and prevents the switch from exceeding the maximum absolute power dissipation of 1.2W.

The following techniques have been identified to improve the thermal performance of this family of devices. These techniques are listed in order of the significance of their impact.

1. Thermal performance of the load switch can be improved by connecting pin7 of the DAP (Die Attach Pad) to the GND plane of the PCB.
2. Embedding two exposed through-hole vias into the DAP (pin7) provides a path for heat to transfer to the back GND plane of the PCB. A drill size of Round, 14 mils (0.35mm) with 1-ounce copper plating is recommended to result in appropriate solder reflow. A smaller size hole prevents the solder from penetrating into the via, resulting in device lift-up. Similarly, a larger via-hole consumes excessive solder, and may result in voiding of the DAP.

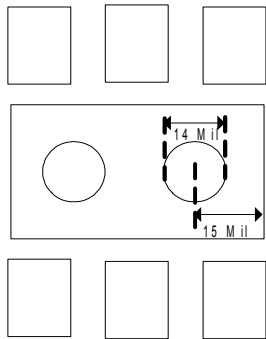

Figure 19: Two through hole open vias embedded in DAP

3. The  $V_{IN}$ ,  $V_{OUT}$  and GND pins will dissipate most of the heat generated during a high load current condition. The layout suggested in Figure 20 provides each pin with adequate copper so that heat may be transferred as efficiently as possible out of the device. The ON pin trace may be laid-out diagonally from the device to maximize the area available to the ground pad. Placing the input and output capacitors as close to the device as possible also contributes to heat dissipation, particularly during high load currents.

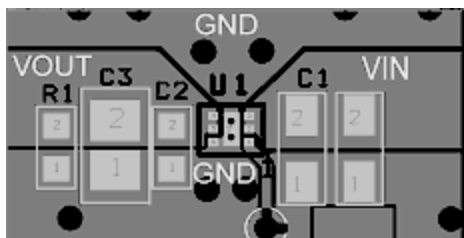

Figure 20: Proper layout of output, input and ground copper area

### Demo Board Layout

FPF1015/6/7/8 Demo board has the components and circuitry to demonstrate FPF1015/6/7/8 load switches functions. Thermal performance of the board is improved using a few techniques recommended in the layout recommendations section of datasheet.

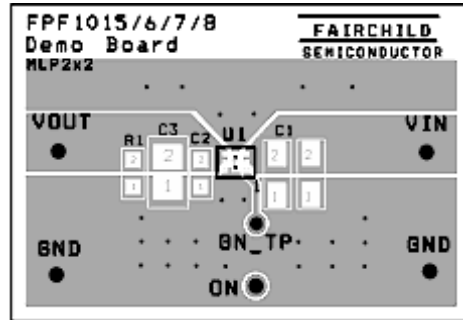
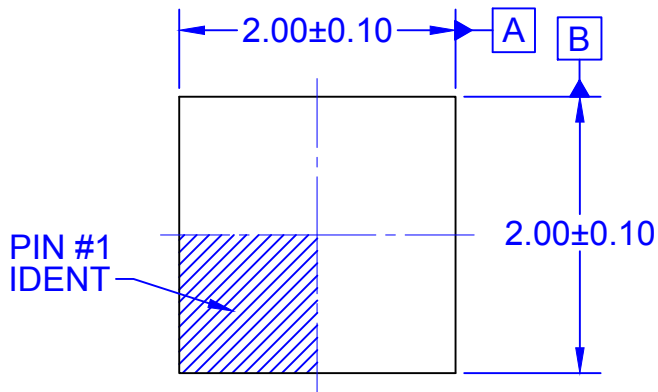
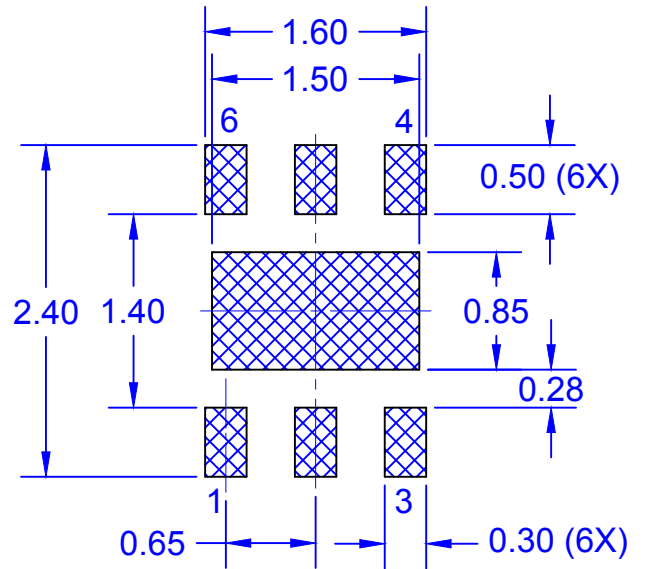

Figure 21. FPF1015/6/7/8 Demo board TOP, SST, ASTOP and DRL layers



TOP VIEW



RECOMMENDED LAND PATTERN

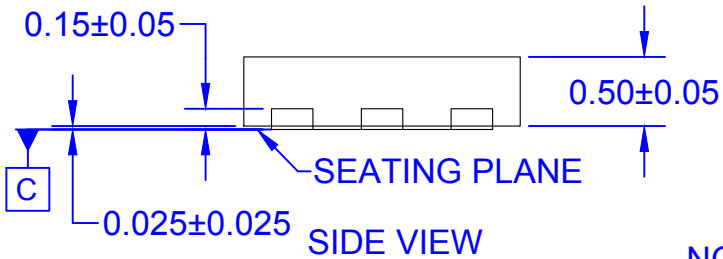

SIDE VIEW

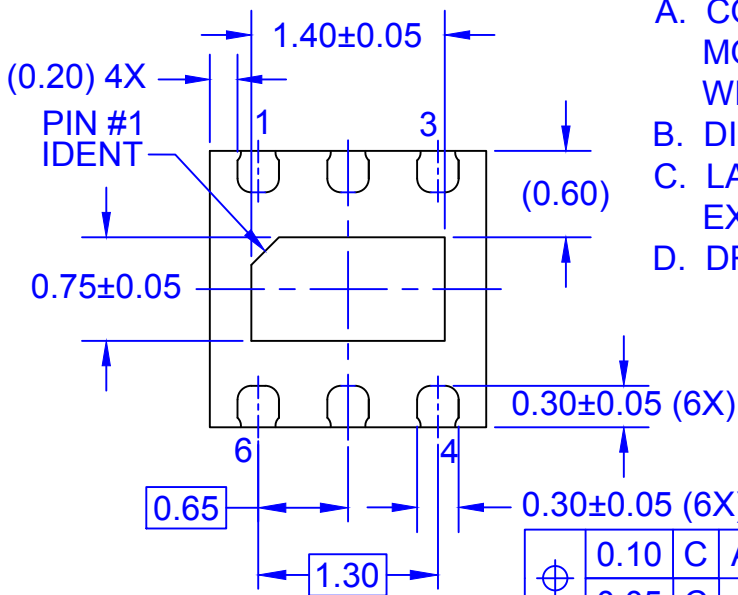

BOTTOM VIEW

NOTES:

- A. CONFORM TO JEDEC REGISTRATIONS MO-229, VARIATION VCCC, EXCEPT WHERE NOTED.
- B. DIMENSIONS ARE IN MILLIMETERS.
- C. LAND PATTERN RECOMMENDATION IS EXISTING INDUSTRY LAND PATTERN.
- D. DRAWING FILENAME: MKT-UMLP16ErevC

**ON Semiconductor**



⌀	0.10	C	A	B
	0.05	C		

ON Semiconductor and  are trademarks of Semiconductor Components Industries, LLC dba ON Semiconductor or its subsidiaries in the United States and/or other countries. ON Semiconductor owns the rights to a number of patents, trademarks, copyrights, trade secrets, and other intellectual property. A listing of ON Semiconductor's product/patent coverage may be accessed at [www.onsemi.com/site/pdf/Patent-Marking.pdf](http://www.onsemi.com/site/pdf/Patent-Marking.pdf). ON Semiconductor reserves the right to make changes without further notice to any products herein. ON Semiconductor makes no warranty, representation or guarantee regarding the suitability of its products for any particular purpose, nor does ON Semiconductor assume any liability arising out of the application or use of any product or circuit, and specifically disclaims any and all liability, including without limitation special, consequential or incidental damages. Buyer is responsible for its products and applications using ON Semiconductor products, including compliance with all laws, regulations and safety requirements or standards, regardless of any support or applications information provided by ON Semiconductor. "Typical" parameters which may be provided in ON Semiconductor data sheets and/or specifications can and do vary in different applications and actual performance may vary over time. All operating parameters, including "Typicals" must be validated for each customer application by customer's technical experts. ON Semiconductor does not convey any license under its patent rights nor the rights of others. ON Semiconductor products are not designed, intended, or authorized for use as a critical component in life support systems or any FDA Class 3 medical devices or medical devices with a same or similar classification in a foreign jurisdiction or any devices intended for implantation in the human body. Should Buyer purchase or use ON Semiconductor products for any such unintended or unauthorized application, Buyer shall indemnify and hold ON Semiconductor and its officers, employees, subsidiaries, affiliates, and distributors harmless against all claims, costs, damages, and expenses, and reasonable attorney fees arising out of, directly or indirectly, any claim of personal injury or death associated with such unintended or unauthorized use, even if such claim alleges that ON Semiconductor was negligent regarding the design or manufacture of the part. ON Semiconductor is an Equal Opportunity/Affirmative Action Employer. This literature is subject to all applicable copyright laws and is not for resale in any manner.

## PUBLICATION ORDERING INFORMATION

### LITERATURE FULFILLMENT:

Literature Distribution Center for ON Semiconductor  
19521 E. 32nd Pkwy, Aurora, Colorado 80011 USA  
**Phone:** 303-675-2175 or 800-344-3860 Toll Free USA/Canada  
**Fax:** 303-675-2176 or 800-344-3867 Toll Free USA/Canada  
**Email:** [orderlit@onsemi.com](mailto:orderlit@onsemi.com)

**N. American Technical Support:** 800-282-9855 Toll Free  
USA/Canada  
**Europe, Middle East and Africa Technical Support:**  
Phone: 421 33 790 2910  
**Japan Customer Focus Center**  
Phone: 81-3-5817-1050

**ON Semiconductor Website:** [www.onsemi.com](http://www.onsemi.com)  
**Order Literature:** <http://www.onsemi.com/orderlit>  
For additional information, please contact your local  
Sales Representative

# Mouser Electronics

Authorized Distributor

Click to View Pricing, Inventory, Delivery & Lifecycle Information:

[ON Semiconductor:](#)

[FPF1018](#)