

MMBT2907A-HF (PNP)

RoHS Device

Halogen Free

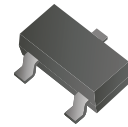

Features

- Epitaxial planar die construction
- Device is designed as a general purpose amplifier and switching.

Mechanical data

- Case: SOT-23, molded plastic.
- Terminals: Solderable per MIL-STD-750, method 2026.
- Weight: 0.0078 grams(approx.).

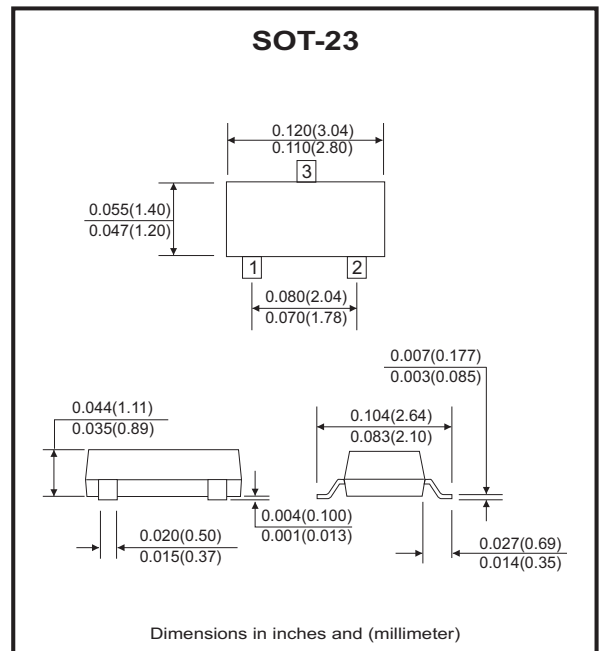

Maximum Ratings (at Ta=25°C unless otherwise noted)

Parameter	Symbol	Value	Unit
Collector-Emitter voltage	V _{CEO}	-60	V
Collector-Base voltage	V _{CBO}	-60	V
Emitter-Base voltage	V _{EBO}	-5	V
Collector current-continuous	I _c	-600	mA

Circuit diagram

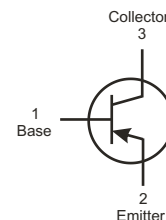

Thermal Characteristics (at Ta=25°C unless otherwise noted)

Parameter	Conditions	Symbol	Value	Unit
Total device dissipation	FR-5 board (Note.1) @ Ta=25°C Derate above 25°C	P _D	225	mW
			1.8	mW / °C
Thermal resistance	Junction to ambient (Note.1)	R _{θJA}	556	°C/W
Total device dissipation	Alumina substrate (Note.2) @ Ta=25°C Derate above 25°C	P _D	300	mW
			2.4	mW / °C
Thermal resistance	Junction to ambient (Note.2)	R _{θJA}	417	°C/W
Junction temperature range		T _J	-55 to +150	°C
Storage temperature range		T _{STG}	-55 to +150	°C

Note. 1. FR-5= 1.0X0.75X0.062 in

2. Alumina = 0.4X0.3X0.024 in . 99.5% alumina.

Company reserves the right to improve product design , functions and reliability without notice.

REV:A

Electrical Characteristics (@ $T_A=25^{\circ}\text{C}$ unless otherwise noted)

OFF CHARACTERISTICS

Parameter	Symbol	Conditions	Min.	Max.	Unit
Collector-Emitter breakdown voltage	$V_{BR(CEO)}$	$I_C=-10\text{mA}, I_B=0$	-60		V
Collector-Base breakdown voltage	$V_{BR(CBO)}$	$I_C=-10\mu\text{A}, I_E=0$	-60		V
Emitter-Base breakdown voltage	$V_{BR(EBO)}$	$I_E=-10\mu\text{A}, I_C=0$	-5		V
Collector cut-off current	I_{CEX}	$V_{CE}=-30\text{V}, V_{EB(off)}=-0.5\text{V}$		-50	nA
Collector cut-off current	I_{CBO}	$V_{CB}=-50\text{V}, I_E=0$	$T_A=25^{\circ}\text{C}$	-0.01	uA
			$T_A=125^{\circ}\text{C}$	-10	
Base current	I_B	$V_{CE}=-30\text{V}, V_{EB(off)}=-0.5\text{V}$		-50	nA

ON CHARACTERISTICS (Note.1)

DC current gain	h_{FE}	$V_{CE}=-10\text{V}, I_C=-0.1\text{mA}$	75		
		$V_{CE}=-10\text{V}, I_C=-1.0\text{mA}$	100		
		$V_{CE}=-10\text{V}, I_C=-10\text{mA}$	100		
		$V_{CE}=-10\text{V}, I_C=-150\text{mA}$ (Note 3)	100	300	
		$V_{CE}=-10\text{V}, I_C=-500\text{mA}$ (Note 3)	50		
Collector-Emitter saturation voltage (Note 3)	$V_{CE(sat)}$	$I_C=-150\text{mA}, I_B=-15\text{mA}$ $I_C=-500\text{mA}, I_B=-50\text{mA}$		-0.4 -1.6	V
Base-Emitter saturation voltage	$V_{BE(sat)}$	$I_C=-150\text{mA}, I_B=-15\text{mA}$ $I_C=-500\text{mA}, I_B=-50\text{mA}$		-1.3 -2.6	V

SMALL-SIGNAL CHARACTERISTICS

Parameter	Symbol	Conditions	Min.	Max.	Unit
Current-Gain-Bandwidth Product (Note 4)	f_T	$V_{CE}=-20\text{V}, I_C=-50\text{mA}$ $f=100\text{MHz}$	200		MHz
Output Capacitance	C_{ob0}	$V_{CB}=-10\text{V}, I_E=0, f=1.0\text{MHz}$		8	pF
Input Capacitance	C_{ib0}	$V_{EB}=-2.0\text{V}, I_C=0, f=1.0\text{MHz}$		30	pF

SWITCHING CHARACTERISTICS

Turn-On time	t_{on}	$V_{CC}=-30\text{V}, I_C=-150\text{mA}, I_{B1}=-15\text{mA}$		45	nS
Delay time	t_d			10	
Rise time	t_r			40	
Storage time	t_s	$V_{CC}=-6\text{V}, I_C=-150\text{mA}, I_{B1}=-I_{B2}=-15\text{mA}$		225	
Fall time	t_f			60	
Turn-off time	t_{off}			280	

Notes:

1. Pulse test: Pulse Width < 300 μs , Duty Cycle < 2.0%.
2. f_T is defined as the frequency at which h_{FE} extrapolates to unity.

RATING AND CHARACTERISTIC CURVES (MMBT2907A-HF)

Fig.1 - DC Current Gain

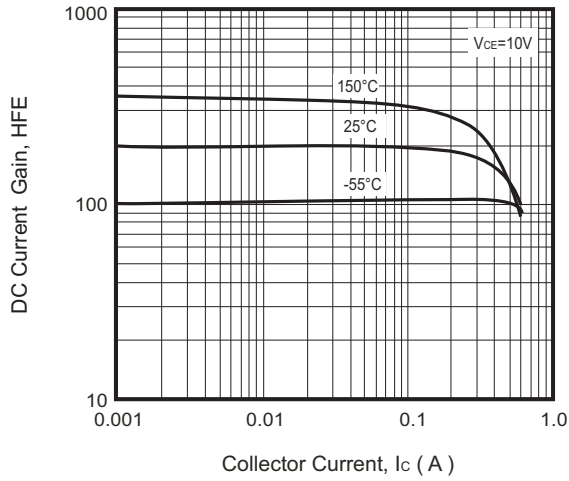

Fig.2 - Collector Saturation Region

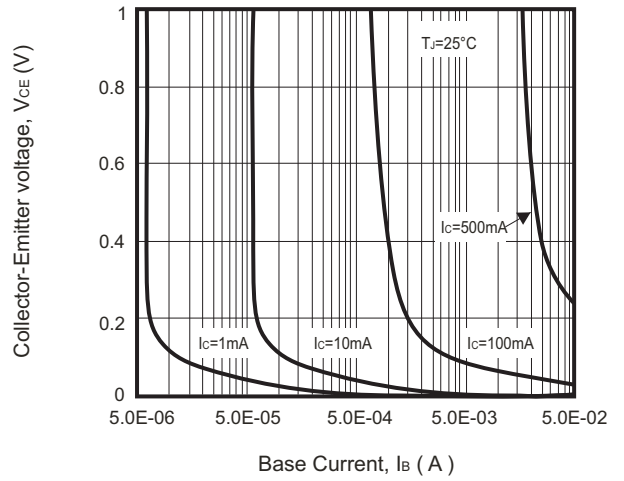

Fig.3 - Collector Emitter Saturation Voltage vs. Collector Current

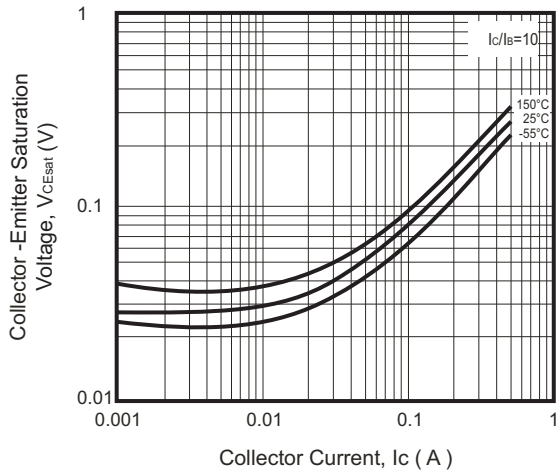

Fig.4 - Base Emitter Saturation Voltage vs. Collector Current

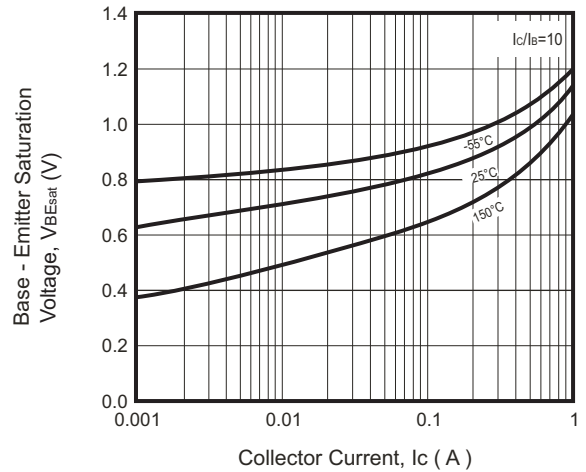

Fig.5 - Base Emitter Voltage vs. Collector Current

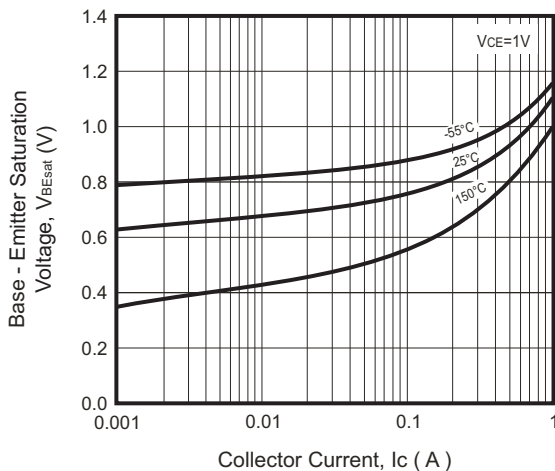
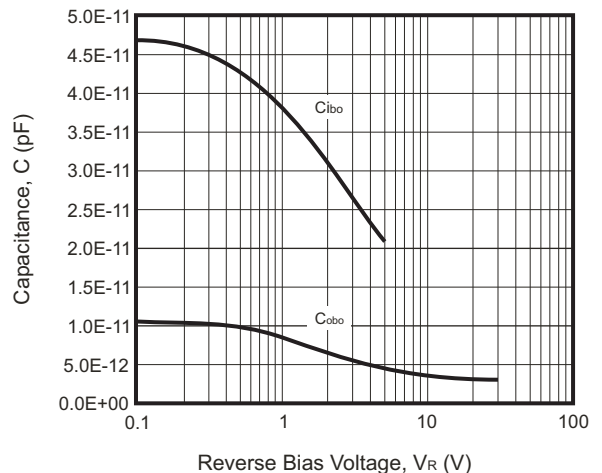
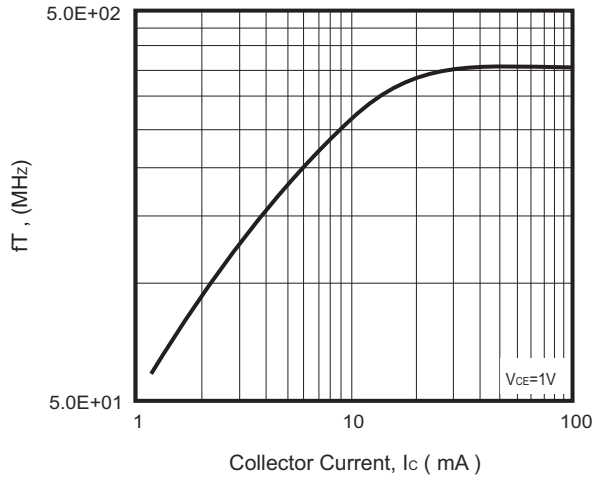

Fig.6 - Capacitance



RATING AND CHARACTERISTIC CURVES (MMBT2907A-HF)

Fig.7 - Current-Gain Bandwidth Product



Reel Taping Specification

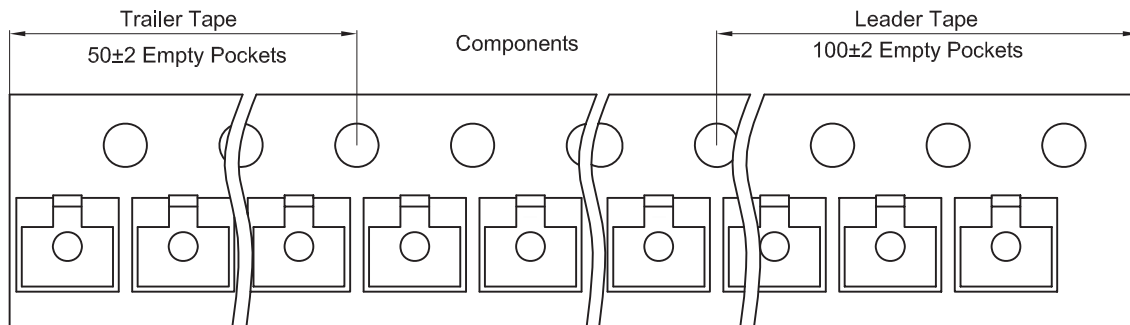
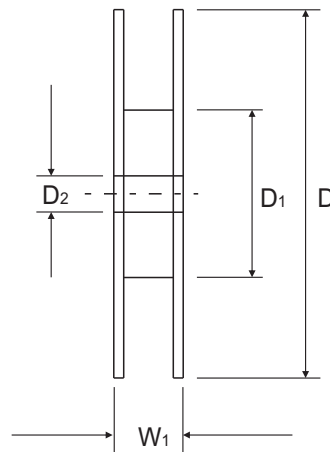
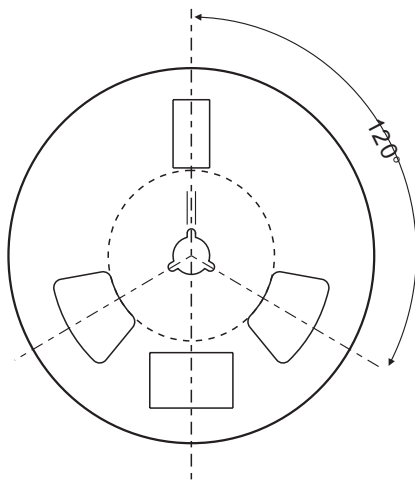
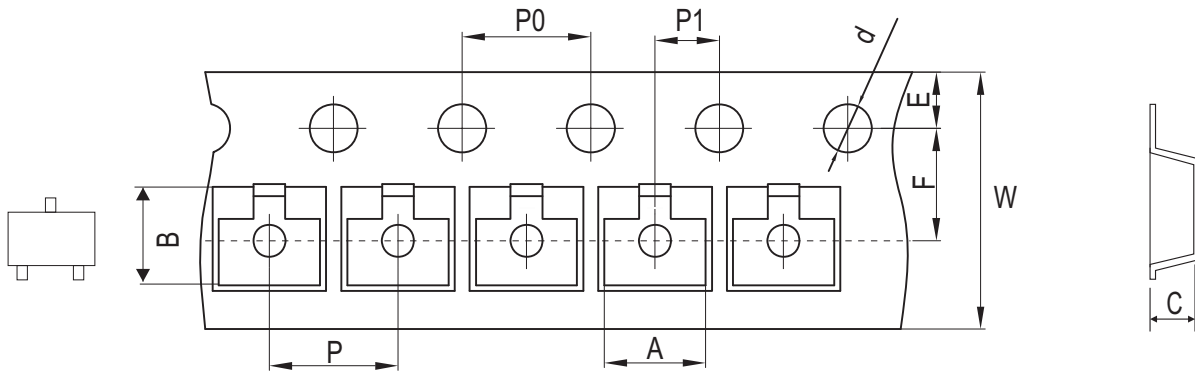

SOT-23	SYMBOL	A	B	C	d	D	D1	D2
	(mm)	See Note 1			$1.50 + 0.10$ $- 0.00$	178 Max.	50.00 Min	13.00 ± 0.50
	(inch)	See Note 1			$0.059 + 0.004$ $- 0.000$	7.008 Max.	1.969 Min	0.512 ± 0.002

SOT-23	SYMBOL	E	F	P	P0	P1	W	W1
	(mm)	1.75 ± 0.10	3.50 ± 0.05	4.00 ± 0.10	4.00 ± 0.10	2.00 ± 0.10	8.30 Max.	10.90 Max.
	(inch)	0.069 ± 0.004	0.138 ± 0.002	0.157 ± 0.004	0.157 ± 0.004	0.079 ± 0.004	0.327 Max.	0.429 Max.

Note: 1. A,B, and C are determined by component size. The clearance between the components and the cavity must be within 0.05mm to 50mm max.

Company reserves the right to improve product design , functions and reliability without notice.

Marking Code

Part Number	Marking Code
MMBT2907A-HF	2F Σ

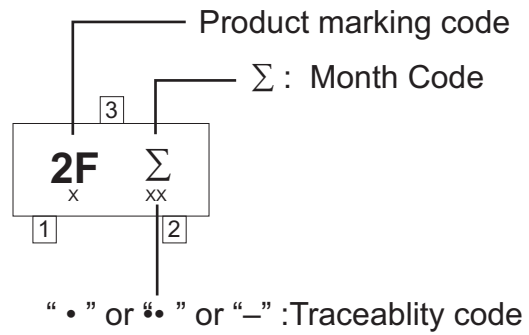

Month Code:

Month	Odd Year (per A.D.)	Even Year (per A.D.)
Jan	1	E
Feb	2	F
Wer	3	H
Apr	4	J
May	5	K
Jun	6	L

Month	Odd Year (per A.D.)	Even Year (per A.D.)
Jul	7	N
Aug	8	P
Sep	9	U
Oct	T	X
Nov	V	Y
Dec	C	Z

Suggested PAD Layout

SIZE	SOT-23	
	(mm)	(inch)
A	0.80	0.031
B	0.90	0.035
C	0.95	0.037
D	2.00	0.079
E	2.90	0.114

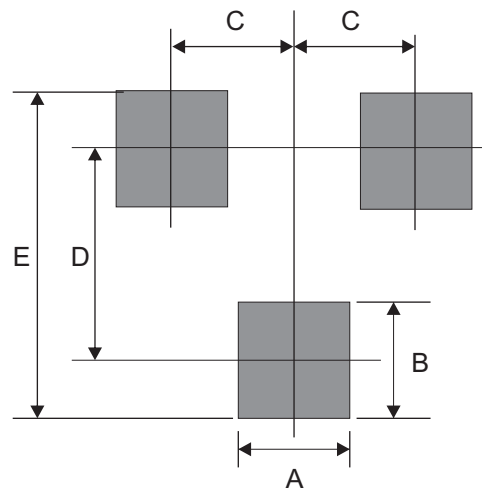

Standard Packaging

Case Type	REEL PACK	
	REEL (pcs)	Reel Size (inch)
SOT-23	3,000	7