

FEATURES

Initial accuracy

A grade: $\pm 0.70\%$ (maximum)

B grade: $\pm 0.35\%$ (maximum)

Maximum temperature coefficient

A grade: 50 ppm/ $^{\circ}\text{C}$

B grade: 25 ppm/ $^{\circ}\text{C}$

$C_{\text{LOAD}} = 50 \text{ nF}$ to $10 \mu\text{F}$

Output current: +4 mA/–2 mA

Low operating current: 80 μA (typical)

Output noise: 6 μV p-p @ 1.0 V output

Input range: 2.0 V to 18 V

Temperature range: -40°C to $+125^{\circ}\text{C}$

Tiny, Pb-free TSOT package

APPLICATIONS

Battery-powered instrumentation

Portable medical equipment

Communication infrastructure equipment

GENERAL DESCRIPTION

The ADR130 is the industry's first family of tiny, micropower, low voltage, high precision voltage references. Featuring 0.35% initial accuracy and 25 ppm/ $^{\circ}\text{C}$ of temperature drift in the tiny TSOT-23 package, the ADR130 voltage reference only requires 80 μA for typical operation. The ADR130 design includes a patented temperature drift curvature correction technique that minimizes the nonlinearities in the output voltage vs. temperature characteristics.

PIN CONFIGURATION

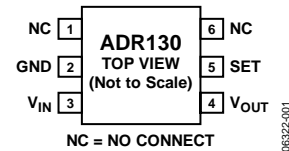

Figure 1. 6-Lead TSOT (UJ-6)

Available in the industrial temperature range of -40°C to $+125^{\circ}\text{C}$, the ADR130 is housed in a tiny TSOT package.

For 0.5 V output, tie SET (Pin 5) to V_{OUT} (Pin 4). For 1.0 V output, tie SET (Pin 5) to GND (Pin 2).

Rev. 0

Information furnished by Analog Devices is believed to be accurate and reliable. However, no responsibility is assumed by Analog Devices for its use, nor for any infringements of patents or other rights of third parties that may result from its use. Specifications subject to change without notice. No license is granted by implication or otherwise under any patent or patent rights of Analog Devices. Trademarks and registered trademarks are the property of their respective owners.

TABLE OF CONTENTS

Features	1	Theory of Operation	12
Applications.....	1	Power Dissipation Considerations.....	12
Pin Configuration.....	1	Input Capacitor.....	12
General Description	1	Output Capacitor.....	12
Revision History	2	Application Notes	13
Specifications.....	3	Basic Voltage Reference Connection	13
Electrical Characteristics.....	3	Stacking Reference ICs for Arbitrary Outputs	13
Absolute Maximum Ratings.....	5	Negative Precision Reference Without Precision Resistors..	14
Thermal Resistance	5	Precision Current Source	14
ESD Caution.....	5	Outline Dimensions	15
Typical Performance Characteristics	6	Ordering Guide	15
Terminology	11		

REVISION HISTORY

10/06—Revision 0: Initial Version

SPECIFICATIONS

ELECTRICAL CHARACTERISTICS

$T_A = 25^\circ\text{C}$, $V_{IN} = 2.0\text{ V}$ to 18 V , unless otherwise noted. SET (Pin 5) tied to V_{OUT} (Pin 4).

Table 1.

Parameter	Symbol	Conditions	Min	Typ	Max	Unit
OUTPUT VOLTAGE	V_O					
A Grade			0.49650	0.5	0.50350	V
B Grade			0.49825	0.5	0.50175	V
INITIAL ACCURACY ERROR	V_{OERR}					
A Grade			-3.50		+3.50	mV
B Grade			-1.75		+1.75	mV
TEMPERATURE COEFFICIENT	TCV_O	$-40^\circ\text{C} < T_A < +125^\circ\text{C}$				
A Grade				15	50	ppm/ $^\circ\text{C}$
B Grade				5	25	ppm/ $^\circ\text{C}$
LOAD REGULATION		$-40^\circ\text{C} < T_A < +125^\circ\text{C}$; $3\text{ V} \leq V_{IN} \leq 18\text{ V}$; $0\text{ mA} < I_{OUT} < 4\text{ mA}$	-0.13		+0.13	mV/mA
		$-40^\circ\text{C} < T_A < +125^\circ\text{C}$; $3\text{ V} \leq V_{IN} \leq 18\text{ V}$; $-2\text{ mA} < I_{OUT} < 0\text{ mA}$	-1.0		+1.0	mV/mA
LINE REGULATION		2.0 V to 18 V , $I_{OUT} = 0\text{ mA}$	-40	+10	+40	ppm/V
QUIESCENT CURRENT	I_Q	$-40^\circ\text{C} < T_A < +125^\circ\text{C}$, no load		75	150	μA
SHORT-CIRCUIT CURRENT TO GROUND		$V_{IN} = 2.0\text{ V}$		15		mA
		$V_{IN} = 18.0\text{ V}$		50		mA
VOLTAGE NOISE		0.1 Hz to 10 Hz		3		$\mu\text{V p-p}$
TURN-ON SETTLING TIME		To 0.1%, $C_L = 0.1\ \mu\text{F}$		80		μs
LONG-TERM STABILITY		1000 hours @ 25°C		100		ppm/1000 hours
OUTPUT VOLTAGE HYSTERESIS				150		ppm

ADR130

$T_A = 25^\circ\text{C}$, $V_{IN} = 2.0\text{ V}$ to 18 V , unless otherwise noted. SET (Pin 5) tied to GND (Pin 2).

Table 2.

Parameter	Symbol	Conditions	Min	Typ	Max	Unit
OUTPUT VOLTAGE	V_O		0.9930	1.0	1.0070	V
A Grade						
B Grade			0.9965	1.0	1.0035	V
INITIAL ACCURACY ERROR	V_{OERR}		-7.0		+7.0	mV
A Grade						
B Grade			-3.5		+3.5	mV
TEMPERATURE COEFFICIENT	TCV_O	$-40^\circ\text{C} < T_A < +125^\circ\text{C}$		15	50	ppm/ $^\circ\text{C}$
A Grade						
B Grade			5	25	ppm/ $^\circ\text{C}$	
LOAD REGULATION		$-40^\circ\text{C} < T_A < +125^\circ\text{C}$; $3\text{ V} \leq V_{IN} \leq 18\text{ V}$; $0\text{ mA} < I_{OUT} < 4\text{ mA}$	-0.25		+0.25	mV/mA
LINE REGULATION		2.0 V to 18 V , $I_{OUT} = 0\text{ mA}$	-40	+10	+40	ppm/V
QUIESCENT CURRENT	I_Q	$-40^\circ\text{C} < T_A < +125^\circ\text{C}$, no load		85	150	μA
SHORT-CIRCUIT CURRENT TO GROUND		$V_{IN} = 2.0\text{ V}$		15		mA
		$V_{IN} = 18.0\text{ V}$		50		mA
VOLTAGE NOISE		0.1 Hz to 10 Hz		6		$\mu\text{V p-p}$
TURN-ON SETTLING TIME		To 0.1%, $C_L = 0.1\ \mu\text{F}$		80		μs
LONG-TERM STABILITY		1000 hours @ 25°C		100		ppm/1000 hours
OUTPUT VOLTAGE HYSTERESIS				150		ppm

ABSOLUTE MAXIMUM RATINGS

Table 3.

Parameter	Ratings
V _{IN} to GND	20 V
Internal Power Dissipation	40 mW
Storage Temperature Range	−65°C to +150°C
Specified Temperature Range	−40°C to +120°C
Lead Temperature, Soldering	
Vapor Phase (60 sec)	215°C
Infrared (15 sec)	220°C

Stresses above those listed under Absolute Maximum Ratings may cause permanent damage to the device. This is a stress rating only; functional operation of the device at these or any other conditions above those indicated in the operational section of this specification is not implied. Exposure to absolute maximum rating conditions for extended periods may affect device reliability.

THERMAL RESISTANCE

θ_{JA} is specified for the worst-case conditions, that is, a device soldered in a circuit board for surface-mount packages.

Table 4. Thermal Resistance

Package Type	θ_{JA}	θ_{JC}	Unit
TSOT (UJ-6)	186	67	°C/W

ESD CAUTION



ESD (electrostatic discharge) sensitive device. Charged devices and circuit boards can discharge without detection. Although this product features patented or proprietary protection circuitry, damage may occur on devices subjected to high energy ESD. Therefore, proper ESD precautions should be taken to avoid performance degradation or loss of functionality.

TYPICAL PERFORMANCE CHARACTERISTICS

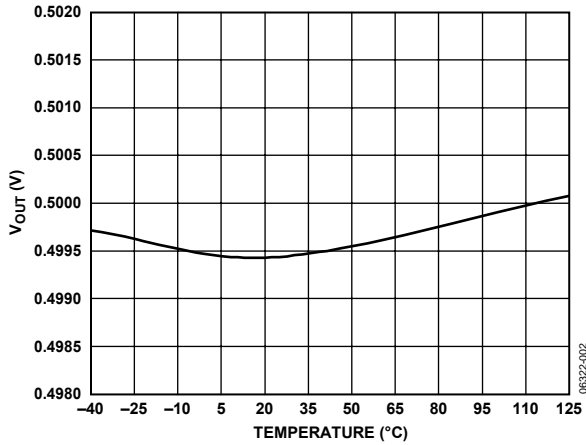

Figure 2. V_{OUT} vs. Temperature, $V_{OUT} = 0.5 V$

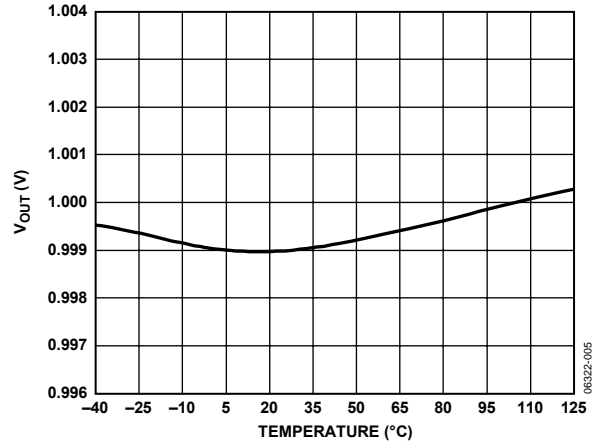

Figure 5. V_{OUT} vs. Temperature, $V_{OUT} = 1 V$

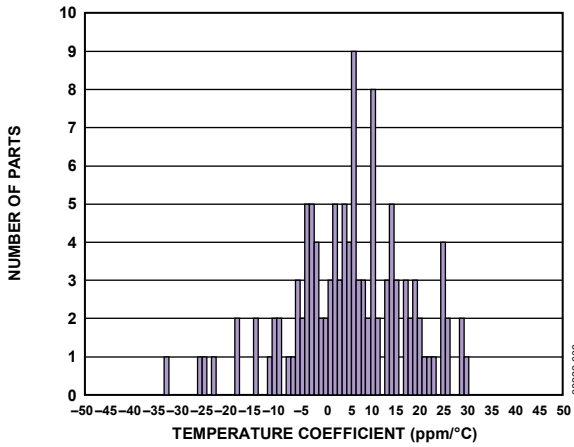

Figure 3. Temperature Coefficient, $V_{OUT} = 0.5 V$

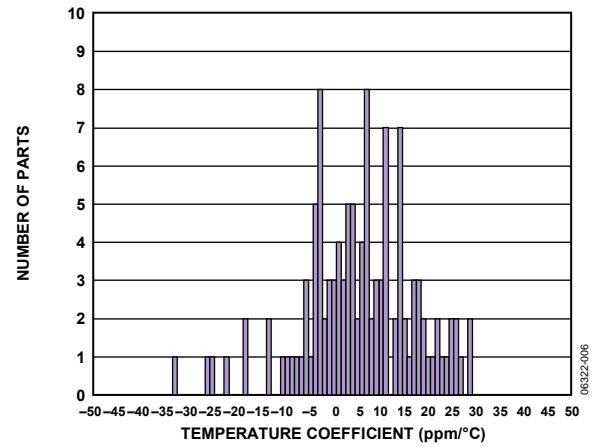

Figure 6. Temperature Coefficient, $V_{OUT} = 1 V$

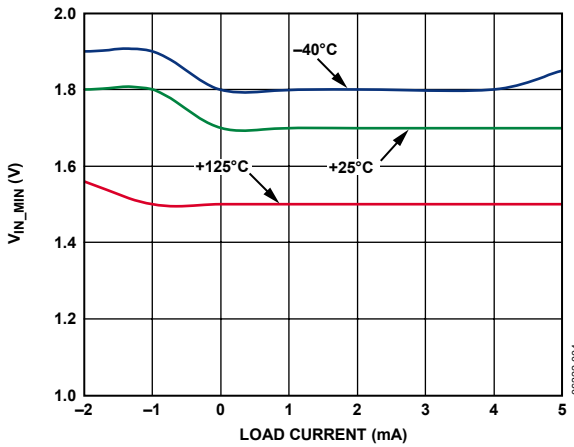

Figure 4. Minimum Input Voltage vs. Load Current, $V_{OUT} = 0.5 V$

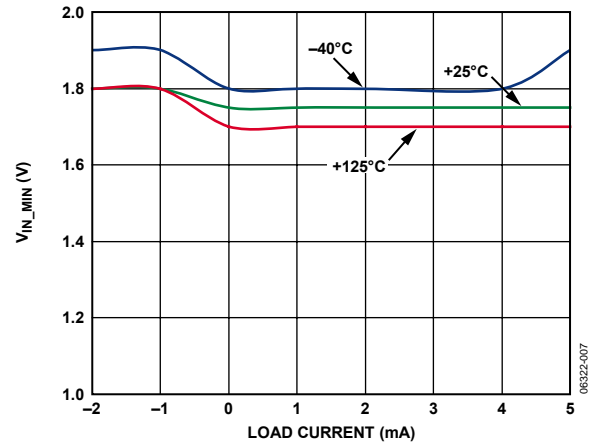

Figure 7. Minimum Input Voltage vs. Load Current, $V_{OUT} = 1 V$

ADR130

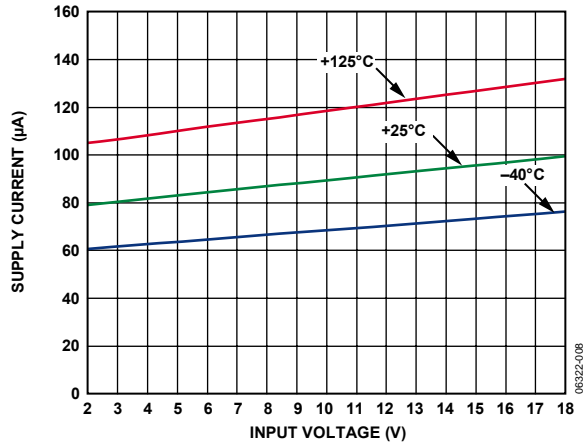

Figure 8. Supply Current vs. Input Voltage, $V_{OUT} = 0.5 V$

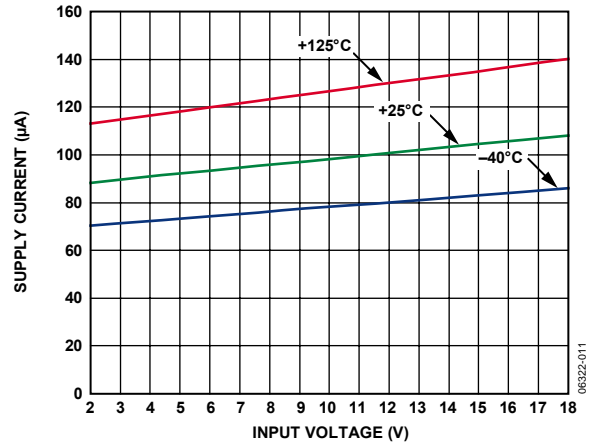

Figure 11. Supply Current vs. Input Voltage, $V_{OUT} = 1 V$

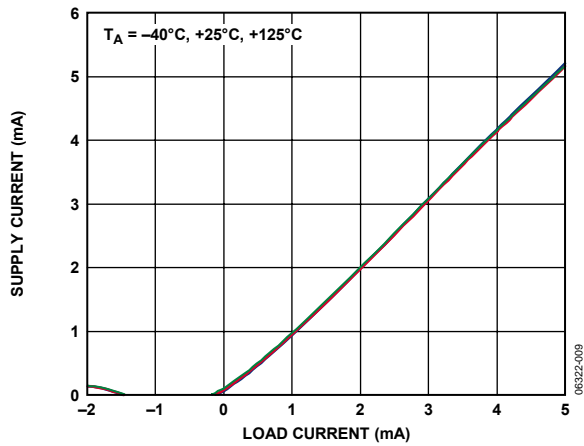

Figure 9. Supply Current vs. Load Current, $V_{OUT} = 0.5 V$

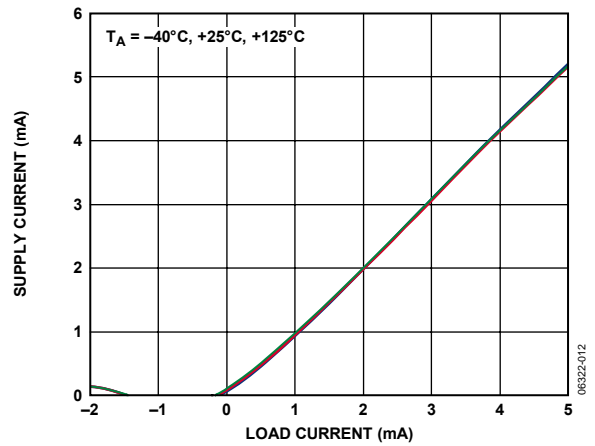

Figure 12. Supply Current vs. Load Current, $V_{OUT} = 1 V$

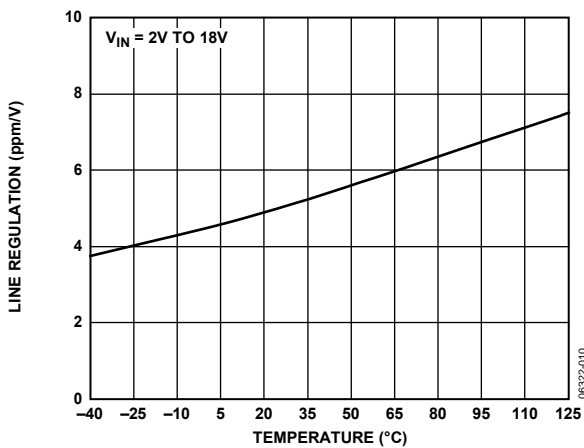

Figure 10. Line Regulation vs. Temperature, $V_{OUT} = 0.5 V$

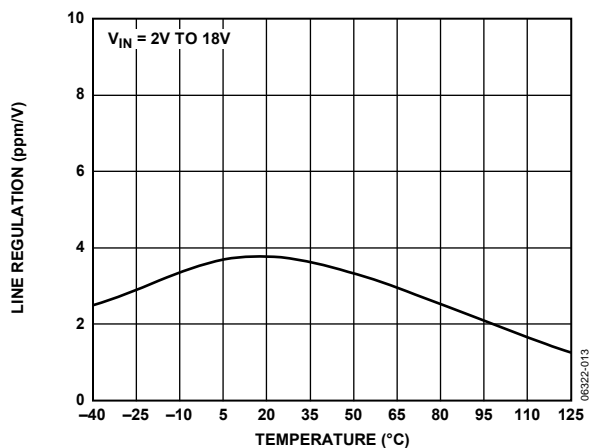

Figure 13. Line Regulation vs. Temperature, $V_{OUT} = 1 V$

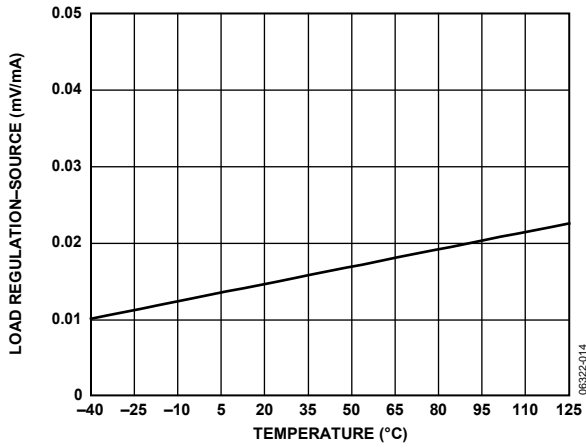

Figure 14. Load Regulation (Source) vs. Temperature, $V_{OUT} = 0.5 V$

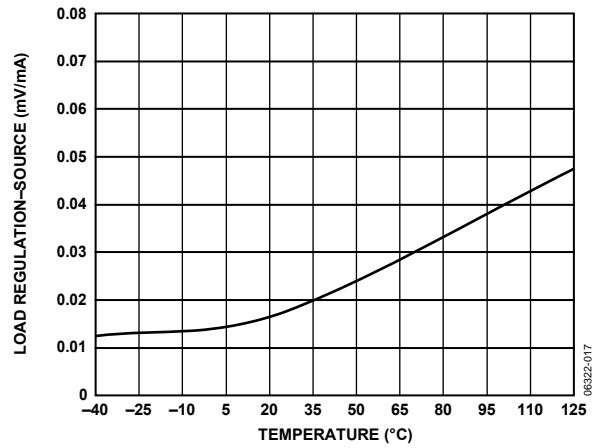

Figure 17. Load Regulation (Source) vs. Temperature, $V_{OUT} = 1 V$

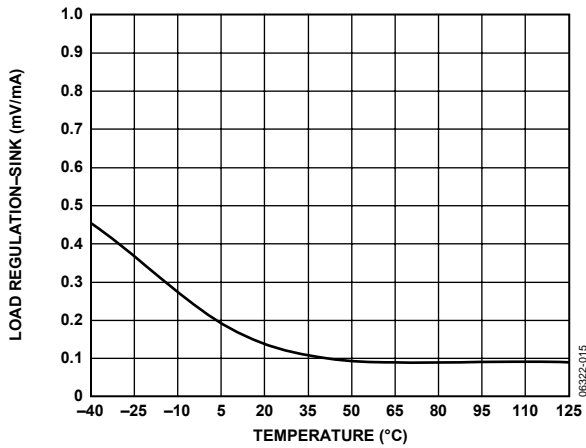

Figure 15. Load Regulation (Sink) vs. Temperature, $V_{OUT} = 0.5 V$

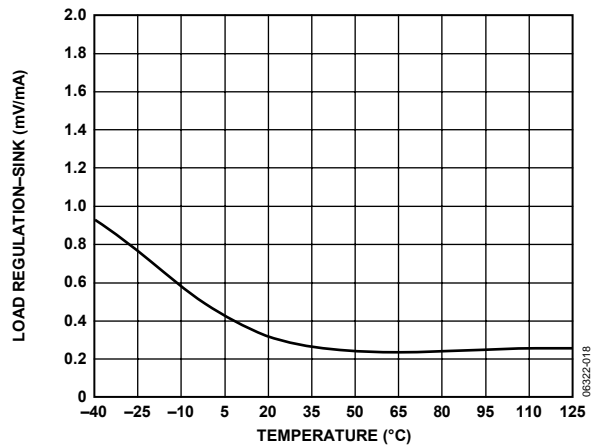

Figure 18. Load Regulation (Sink) vs. Temperature, $V_{OUT} = 1 V$

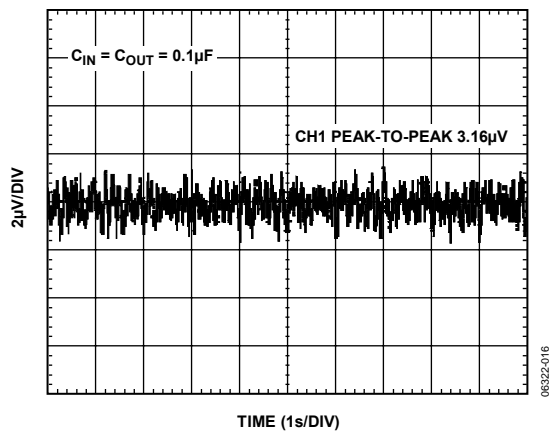

Figure 16. 0.1 Hz to 10 Hz Noise, $V_{OUT} = 0.5 V$

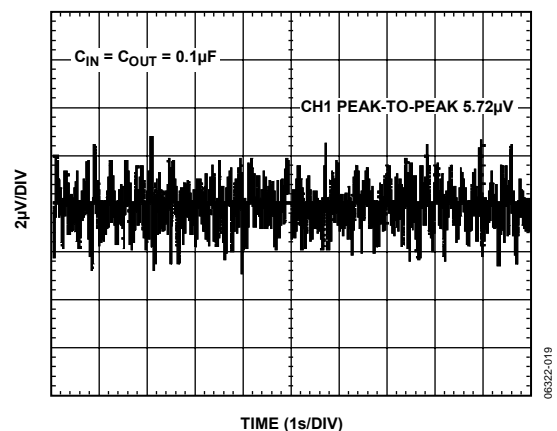

Figure 19. 0.1 Hz to 10 Hz Noise, $V_{OUT} = 1 V$

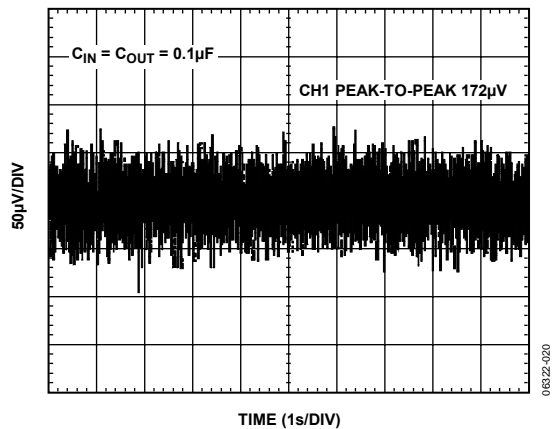

Figure 20. 10 Hz to 10 kHz Noise, $V_{OUT} = 0.5 V$

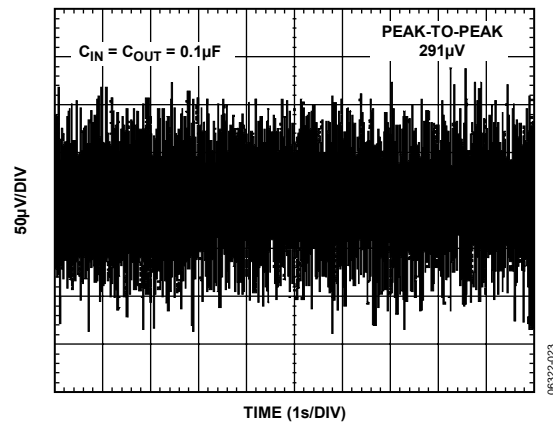

Figure 23. 10 Hz to 10 kHz Noise, $V_{OUT} = 1 V$

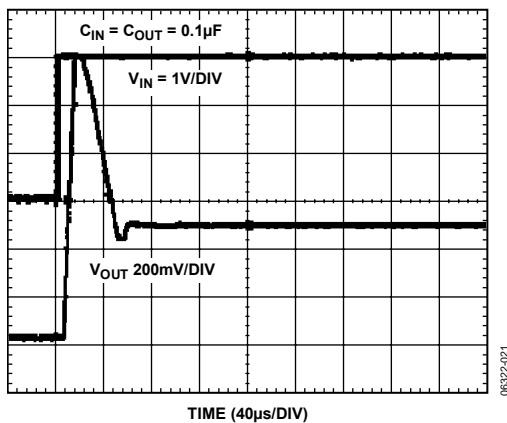

Figure 21. Turn-On Response, $V_{OUT} = 0.5 V$

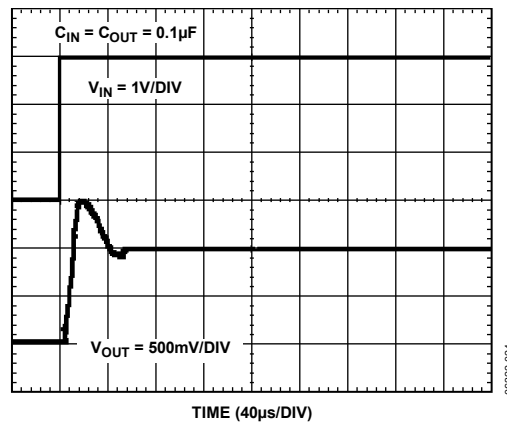

Figure 24. Turn-On Response, $V_{OUT} = 1 V$

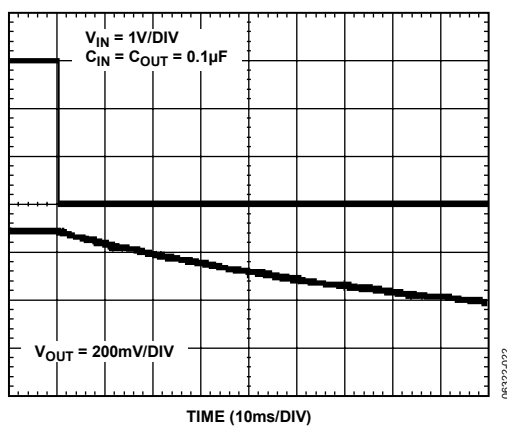

Figure 22. Turn-Off Response, $V_{OUT} = 0.5 V$

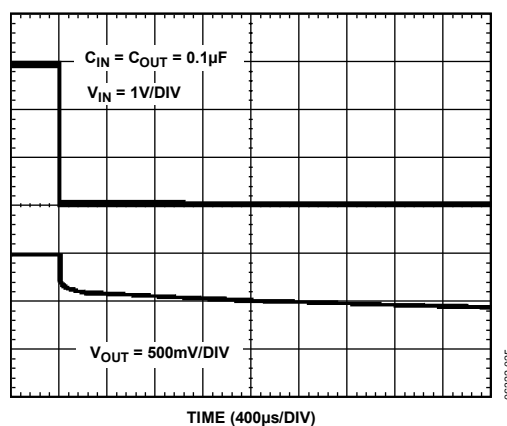

Figure 25. Turn-Off Response, $V_{OUT} = 1 V$

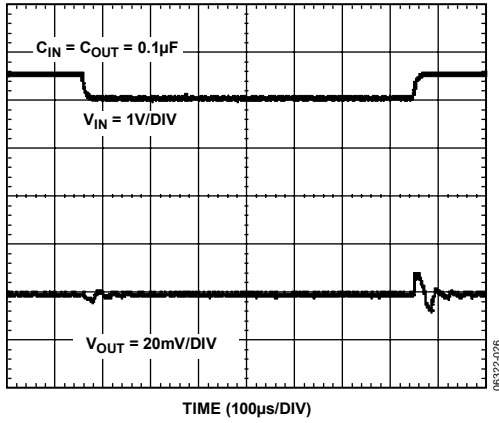

Figure 26. Line Transient Response, $V_{OUT} = 0.5 V$

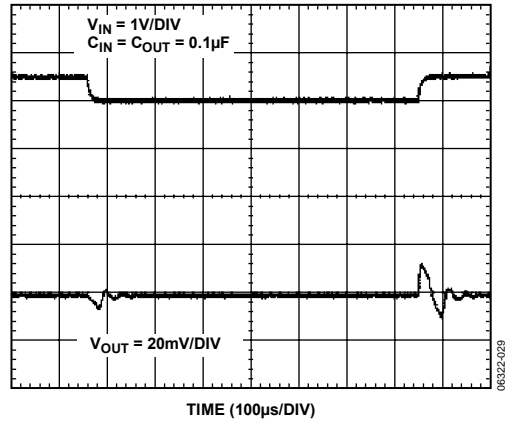

Figure 29. Line Transient Response, $V_{OUT} = 1 V$

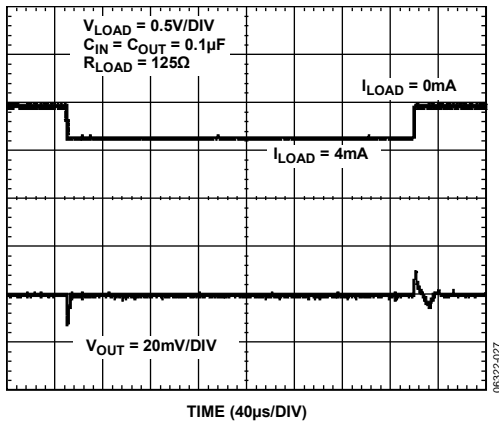

Figure 27. Load Transient Response (Source), $V_{OUT} = 0.5 V$

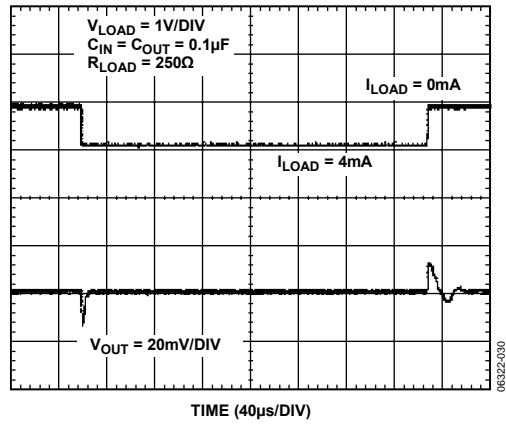

Figure 30. Load Transient Response (Source), $V_{OUT} = 1 V$

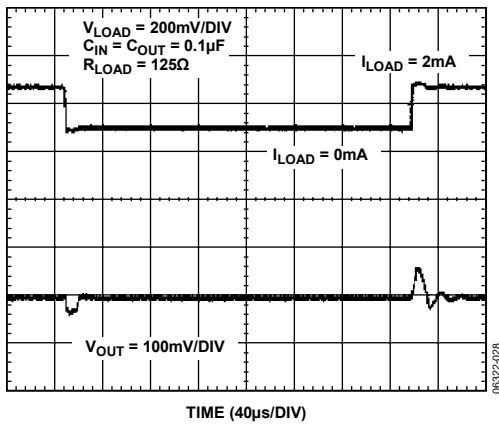

Figure 28. Load Transient Response (Sink), $V_{OUT} = 0.5 V$

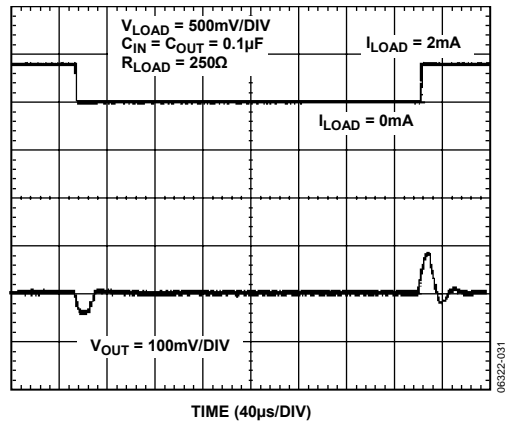

Figure 31. Load Transient Response (Sink), $V_{OUT} = 1 V$

TERMINOLOGY

Temperature Coefficient

Temperature coefficient is the change of output voltage with respect to the operating temperature change normalized by the output voltage at 25°C. This parameter is expressed in ppm/°C and is determined by

$$TCV_O [\text{ppm}/^\circ\text{C}] = \frac{V_O(T_2) - V_O(T_1)}{V_O(25^\circ\text{C}) \times (T_2 - T_1)} \times 10^6$$

where:

$V_O(25^\circ\text{C}) = V_O$ at 25°C.

$V_O(T_1) = V_O$ at Temperature 1.

$V_O(T_2) = V_O$ at Temperature 2.

Line Regulation

Line regulation is the change in the output due to a specified change in input voltage. This parameter accounts for the effects of self-heating. Line regulation is expressed in either %/V, ppm/V, or $\mu\text{V}/\Delta V_{\text{IN}}$.

Load Regulation

Load regulation is the change in output voltage due to a specified change in load current. This parameter accounts for the effects of self-heating. Load regulation is expressed in either mV/mA, ppm/mA, or dc output resistance (Ω).

Long-Term Stability

Long-term stability is the typical shift of output voltage at 25°C on a sample of parts subjected to a test of 1000 hours at 25°C.

$$\Delta V_O = V_O(t_0) - V_O(t_1)$$

$$\Delta V_O [\text{ppm}] = \frac{V_O(t_0) - V_O(t_1)}{V_O(t_0)} \times 10^6$$

where:

$V_O(t_0) = V_O$ at 25°C at Time 0.

$V_O(t_1) = V_O$ at 25°C after 1000 hours operating at 25°C.

Thermal Hysteresis

Thermal hysteresis is the change of output voltage after the device is cycled through temperatures from +25°C to -40°C to +125°C, then back to +25°C. This is a typical value from a sample of parts put through such a cycle.

where:

$V_O(25^\circ\text{C}) = V_O$ at 25°C.

$V_{Orc} = V_O$ at 25°C after temperature cycle from +25°C to -40°C to +125°C, then back to +25°C.

THEORY OF OPERATION

The ADR130 sub-band gap reference is the high performance solution for low supply voltage and low power applications. The uniqueness of this product lies in its architecture.

POWER DISSIPATION CONSIDERATIONS

The ADR130 is capable of delivering load currents to 4 mA with an input range from 3.0 V to 18 V. When this device is used in applications with large input voltages, care must be taken to avoid exceeding the specified maximum power dissipation or junction temperature, because this results in premature device failure.

Use the following formula to calculate the maximum junction temperature or dissipation:

$$P_D = \frac{T_J - T_A}{\theta_{JA}}$$

where:

T_J is the junction temperature.

T_A is the ambient temperature.

P_D is the device power dissipation.

θ_{JA} is the device package thermal resistance.

INPUT CAPACITOR

Input capacitors are not required on the ADR130. There is no limit for the value of the capacitor used on the input, but a 1 μF to 10 μF capacitor on the input improves transient response in applications where there is a sudden supply change. An additional 0.1 μF capacitor in parallel also helps reduce noise from the supply.

OUTPUT CAPACITOR

The ADR130 requires a small 0.1 μF output capacitor for stability. Additional 0.1 μF to 10 μF capacitance in parallel can improve load transient response. This acts as a source of stored energy for a sudden increase in load current. The only parameter affected by the additional capacitance is turn-on time.

APPLICATION NOTES

BASIC VOLTAGE REFERENCE CONNECTION

The circuits in Figure 32 and Figure 33 illustrate the basic configuration for the ADR130 voltage reference.

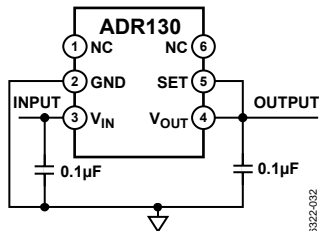

Figure 32. Basic Configuration, $V_{OUT} = 0.5\text{ V}$

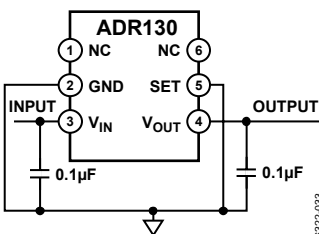

Figure 33. Basic Configuration, $V_{OUT} = 1\text{ V}$

STACKING REFERENCE ICs FOR ARBITRARY OUTPUTS

Some applications may require two reference voltage sources that are a combined sum of the standard outputs. Figure 34 and Figure 35 show how these stacked output references can be implemented.

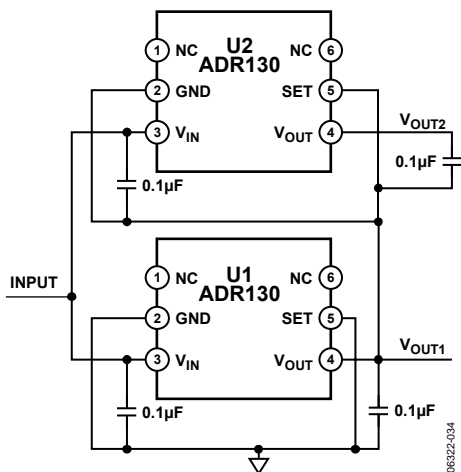

Figure 34. Stacking References with ADR130, $V_{OUT1} = 1.0\text{ V}$, $V_{OUT2} = 2.0\text{ V}$

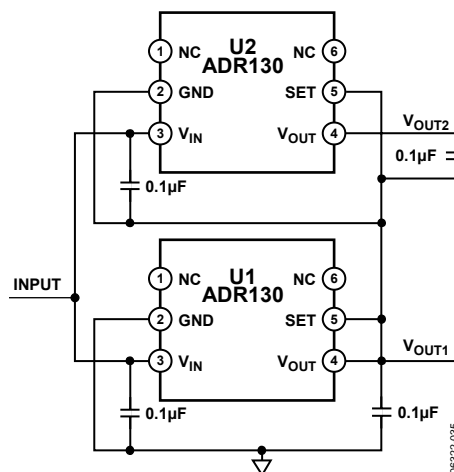

Figure 35. Stacking References with ADR130, $V_{OUT1} = 0.5\text{ V}$, $V_{OUT2} = 1.5\text{ V}$

Two reference ICs are used and fed from an unregulated input, V_{IN} . The outputs of the individual ICs that are connected in series provide two output voltages, V_{OUT1} and V_{OUT2} . V_{OUT1} is the terminal voltage of U1, and V_{OUT2} is the sum of this voltage and the terminal voltage of U2. U1 and U2 are chosen for the two voltages that supply the required outputs (see Table 5). For example, if U1 is set to have an output of 1 V or 0.5 V, the user can stack on top of U2 to get an output of 2 V or 1.5 V.

Table 5. Required Outputs

U1/U2	Comments	V_{OUT1}	V_{OUT2}
ADR130/ADR130	See Figure 34	1 V	2 V
ADR130/ADR130	See Figure 35	0.5 V	1.5 V

ADR130

NEGATIVE PRECISION REFERENCE WITHOUT PRECISION RESISTORS

A negative reference is easily generated by adding an op amp, A1, and is configured as shown in Figure 36. V_{OUT} is at virtual ground and, therefore, the negative reference can be taken directly from the output of the op amp. The op amp must be dual-supply, low offset, and rail-to-rail if the negative supply voltage is close to the reference output.

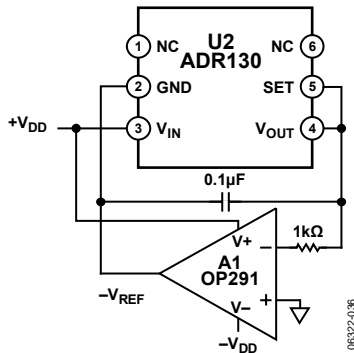

Figure 36. Negative Reference, $-V_{REF} = -0.5 V$

PRECISION CURRENT SOURCE

In low power applications, the need can arise for a precision current source that can operate on low supply voltages. The ADR130 can be configured as a precision current source (see Figure 37). The circuit configuration shown is a floating current source with a grounded load. The reference output voltage is bootstrapped across R_{SET} , which sets the output current into the load. With this configuration, circuit precision is maintained for load currents ranging from the reference supply current, typically $85 \mu A$, to approximately $4 mA$.

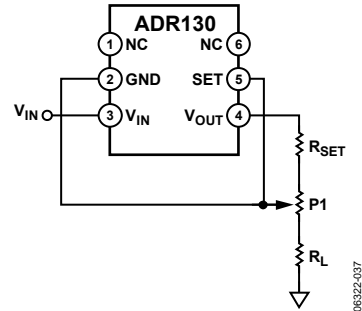
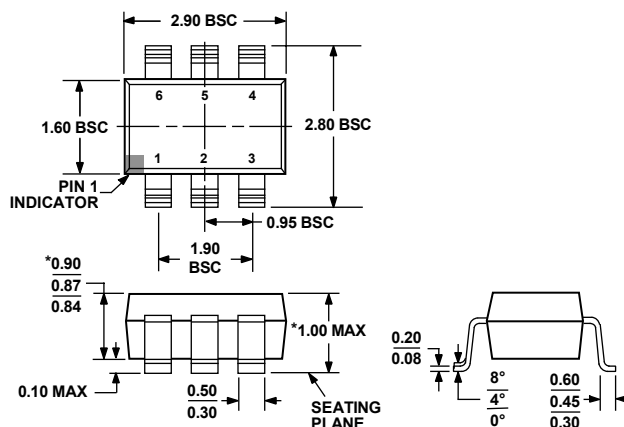

Figure 37. ADR130 as a Precision Current Source

OUTLINE DIMENSIONS



*COMPLIANT TO JEDEC STANDARDS MO-193-AA WITH THE EXCEPTION OF PACKAGE HEIGHT AND THICKNESS.

Figure 38. 6-Lead Thin Small Outline Transistor Package [TSOT] (UJ-6)

Dimensions shown in millimeters

ORDERING GUIDE

Model	Temperature Coefficient (ppm/°C)	Temperature Range	Package Description	Package Option	Branding	Ordering Quantity
ADR130AUJZ-REEL7 ¹	50	-40°C to +125°C	6-Lead TSOT	UJ-6	R0W	3,000
ADR130AUJZ-R2 ¹	50	-40°C to +125°C	6-Lead TSOT	UJ-6	R0W	250
ADR130BUJZ-REEL7 ¹	25	-40°C to +125°C	6-Lead TSOT	UJ-6	R0X	3,000
ADR130BUJZ-R2 ¹	25	-40°C to +125°C	6-Lead TSOT	UJ-6	R0X	250

¹ Z = Pb-free part.

ADR130

NOTES