



Main

| | |
|-------------------------------|--|
| Range of product | OsiSense XC |
| Series name | Standard format |
| Product or component type | Limit switch |
| Device short name | XCMD |
| Sensor design | Miniature |
| Body type | Plug-in body |
| Head type | M16 plunger head |
| Material | Metal |
| Body material | Zamak |
| Head material | Zamak |
| Fixing mode | By the head |
| Movement of operating head | Linear |
| Type of operator | Spring return roller plunger metal (with elastomer boot) |
| Type of approach | Vertical approach 1 direction |
| Number of poles | 2 |
| Contacts type and composition | 1 NC + 1 NO |
| Contact operation | Snap action |

Complementary

| | |
|--|--|
| Switch actuation | On end |
| Electrical connection | Male connector M12, 5 pins |
| Contacts insulation form | Zb |
| Positive opening | With |
| Positive opening minimum force | 42.5 N |
| Minimum force for tripping | 8.5 N |
| Minimum actuation speed | 0.01 m/min |
| Maximum actuation speed | 1.64 ft/s (0.5 m/s) |
| [Ie] rated operational current | 0.22 A at 50 V, DC-13 conforming to EN/IEC 60947-5-1 appendix A 3 A at 50 V, AC-15 conforming to EN/IEC 60947-5-1 appendix A |
| [Ithe] conventional enclosed thermal current | 4 A |
| [Ui] rated insulation voltage | 60 V degree of pollution 3 conforming to IEC 60947-5-1 |
| Resistance across terminals | <= 25 MOhm conforming to IEC 60255-7 category 3 |
| [Uimp] rated impulse withstand voltage | 0.8 kV conforming to IEC 60664 0.8 kV conforming to IEC 60947-1 |
| Short-circuit protection | 4 A by gG cartridge fuse |
| Electrical durability | 5000000 cycles, DC-13, 24 V, 3 W, operating rate: <= 60 cyc/mn, load factor: 0.5 conforming to IEC 60947-5-1 appendix C 5000000 cycles, DC-13, 48 V, 2 W, operating rate: <= 60 cyc/mn, load factor: 0.5 conforming to IEC 60947-5-1 appendix C |
| Mechanical durability | 10000000 cycles |
| Width | 1.18 in (30 mm) |
| Height | 1.97 in (50 mm) |
| Depth | 0.63 in (16 mm) |
| Product weight | 0.28 lb(US) (0.125 kg) |

Environment

| | |
|------------------|---|
| shock resistance | 25 gn (duration = 18 ms) conforming to IEC 60068-2-27 |
|------------------|---|

The information provided in this documentation contains general descriptions and/or technical characteristics of the products contained herein. This documentation is not intended as a substitute for and is not to be used for determining suitability or reliability of these products for specific user applications. It is the duty of any such user or integrator to perform the appropriate and complete risk analysis, evaluation and testing of the products with respect to the relevant specific application or use thereof. Neither Schneider Electric Industries SAS nor any of its affiliates or subsidiaries shall be responsible or liable for misuse of the information contained herein.

| | |
|---------------------------------------|--|
| vibration resistance | 5 gn (f = 10...500 Hz) conforming to IEC 60068-2-6 |
| IP degree of protection | IP68 conforming to IEC 60529 IP66 conforming to IEC 60529 IP67 conforming to IEC 60529 |
| IK degree of protection | IK06 conforming to EN 62262 |
| electrical shock protection class | Class I conforming to IEC 61140 Class I conforming to NF C 20-030 |
| ambient air temperature for operation | -13...158 °F (-25...70 °C) |
| ambient air temperature for storage | -40...158 °F (-40...70 °C) |
| protective treatment | TC |
| product certifications | CCC CSA UL |
| standards | EN/IEC 60204-1 EN/IEC 60947-5-1 UL 508 CSA C22.2 No 14 |

Offer Sustainability

| | |
|--|--|
| Green Premium product | Green Premium product |
| Compliant - since 1002 - Schneider Electric declaration of conformity | Compliant - since 1002 - Schneider Electric declaration of conformity |
| Reference not containing SVHC above the threshold | Reference not containing SVHC above the threshold |
| Available | Available |
| Need no specific recycling operations | Need no specific recycling operations |
| WARNING: This product can expose you to chemicals including: | WARNING: This product can expose you to chemicals including: |
| Diisononyl phthalate (DINP), which is known to the State of California to cause cancer, and | Diisononyl phthalate (DINP), which is known to the State of California to cause cancer, and |
| Di-isodecyl phthalate (DIDP), which is known to the State of California to cause birth defects or other reproductive harm. | Di-isodecyl phthalate (DIDP), which is known to the State of California to cause birth defects or other reproductive harm. |
| For more information go to www.p65warnings.ca.gov | For more information go to www.p65warnings.ca.gov |

Contractual warranty

| | |
|-----------------|-----------|
| Warranty period | 18 months |
|-----------------|-----------|

Dimensions

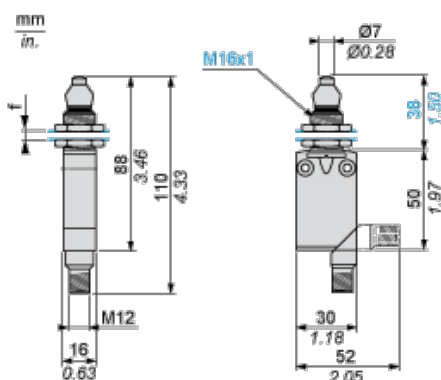

f : 8 mm max., panel cut-out Ø 16.5 mm, fixing nut thickness 3.5 mm.

Panel Mounting

Mounting and Fixing Limit Switches by the Head

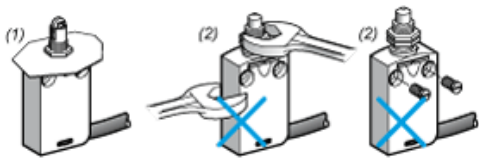

- (1) Recommended
- (2) Forbidden

Setting-up

Plunger or Multi-directional Heads

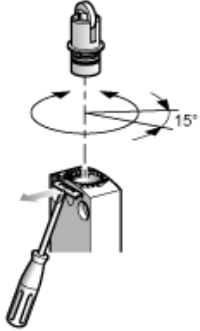

Wiring Diagram

2-pole NC + NO Snap Action + Integral M12 5-pin Connector

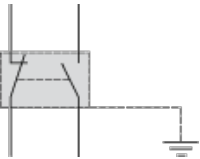

Wiring Diagram

5-pin, M12, 4A-60V

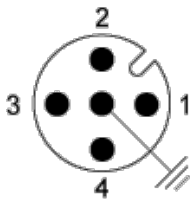

- 1 - NC
- 2 :
- 3 - NO
- 4 :
- 5 : Grounding

Characteristics of Actuation

Switch Actuation on End

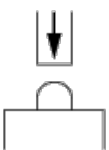

Functionnal Diagram

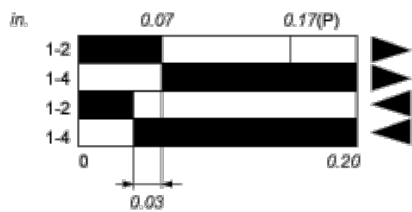
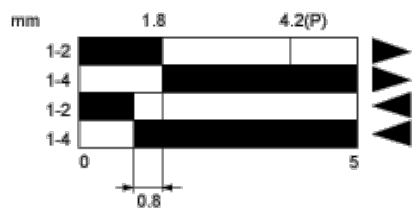

- (1)
- (2)
- ▲ (3)
- ▼ (4)

- (P) Positive opening point
- (1) Closed
- (2) Open
- (4) Tripping
- (5) Resetting