

## FEED-THROUGH

### 35 or 32mm DIN Rail

Altech "U" Series Universal Rail Mounting Standard Screw Clamp Feed through terminals are the most versatile terminals for wire-to-wire connection in control, automation, instrumentation and power distribution applications. A special design feature on the flexible foot enables easy mounting and dismounting from the DIN Rail with the help of a screwdriver.

**The terminals with AEx eII EEx eII can be used in a potentially explosive atmosphere which may occur in chemical and petrochemical industry. These terminals can be used in Class 1, Zone 0, 1 & 2 hazardous locations. These terminal blocks comply to En 500019.**



### COLOR BLOCKS

(other than grey standard)

When ordering please add color suffix to Cat. No.

Example: CTS2.5U-N/R

Color	Ordering Suffix
Red	R
Blue	BU
Black	BL
Orange	O
Green	G
Yellow	Y
White	W
Beige	BG
Dark Brown	DB

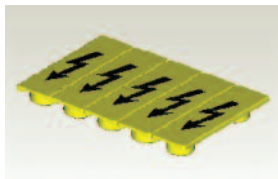

Warning labels available. See page 67.

\* 35A with one No. 10 AWG and 40A with two No. 12 AWG wires.

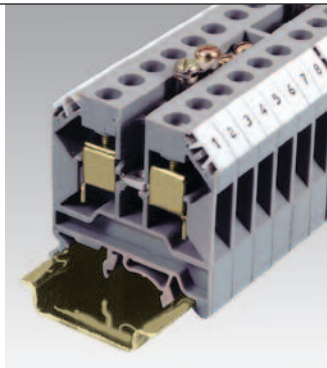

Terminal Width	5 mm
Height x Length	45 x 43 mm
Stripping Length	9 mm
Insulation Material	Polyamide 6.6
Type of Connection	2 screw clamps & 1 tapped hole for cross connection
Approvals	
Wire Range	22-12 AWG 0.5-2.5 sq.mm 22-14 AWG
Voltage Rating	600 V 750 V 600 V
Current Rating	25 A 24 A 20 A
Torque	7 lb-in 0.4 Nm 7 lb-in



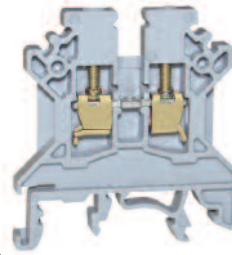



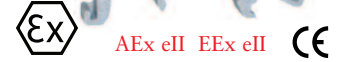
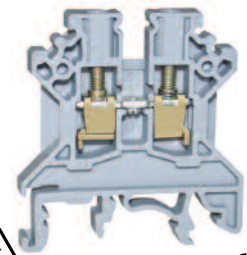





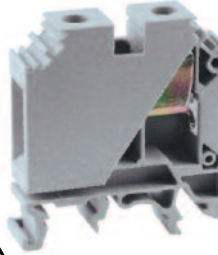













### CTS2.5U-N











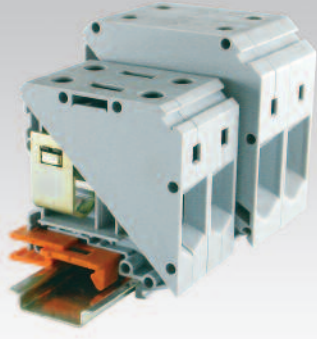
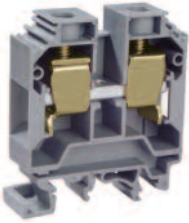

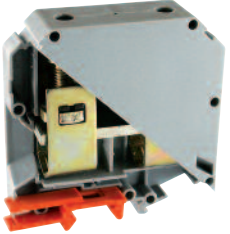







### CTS4U-N



Terminal Block	Cat. No.	Std. Pk.	Cat. No.	Std. Pk.
Terminal Block	CTS2.5U-N	100	CTS4U-N	100
End Plate	EP2.5/4UN	50	EP2.5/4UN	50
Isolation Partition	PP2.5/4UN	50	PP2.5/4UN	50
Separator Plate	SP2.5/4UN	100	SP2.5/4UN	100
DIN Rail for ordering information refer to page 62				
End Stop for ordering information refer to page 63	CA702 CA802	50 50	CA702 CA802	50 50
Internal Jumper	2 pole CA721/2 3 pole CA721/3 4 pole CA721/4 10 pole CA721/10 100 pole CA721/100	100 50 50 10 10	2 pole CA722/2 3 pole CA722/3 4 pole CA722/4 10 pole CA722/10 100 pole CA722/100	100 50 50 10 10
Insulated Internal Jumper	2 pole CA741/2 3 pole CA741/3 4 pole CA741/4 10 pole CA741/10 100 pole CA741/100	100 50 50 10 10	2 pole CA742/2 3 pole CA742/3 4 pole CA742/4 10 pole CA742/10 100 pole CA742/100	100 50 50 10 10
Current Bars	2 pole CA703/01 3 pole CA704/01 4 pole CA705/01 10 pole CA731/10 10 pole (breakable) — 100 pole CA731/100	100 100 100 100 — 10	2 pole CA703/1 3 pole CA704/1 4 pole CA705/1 10 pole CA732/10 100 pole CA732/10-A 100 pole CA732/100	100 100 100 100 100 10
Shorting Sleeve & Screw	CA 707/S/Q/01	100	CA707/S/Q/01	100
External Jumper	2 pole CA717/2 3 pole CA717/3 4 pole CA717/4 10 pole CA717/10	100 100 100 25	2 pole CA713/2 3 pole CA713/3 4 pole CA713/4 10 pole CA713/10	100 100 50 25
Marking Tags	MT5	100	MT6	100
Warning Label				

CTS6U		CTS10U		CTS16U		CTS25U	
							
 AEx eH EEx eH 		 AEx eH EEx eH 		 AEx eH EEx eH 		 AEx eH EEx eH 	
8 mm		10 mm		12 mm		12 mm	
47 x 43 mm		47 x 43 mm		47 x 43 mm		56 x 49.5 mm	
12 mm		12 mm		16 mm		18 mm	
Polyamide 6.6		Polyamide 6.6		Polyamide 6.6		Polyamide 6.6	
2 screw clamps & 1 tapped hole for cross connection		2 screw clamps & 1 tapped hole for cross connection		2 screw clamps & 1 tapped hole for cross connection		2 screw clamps & 1 tapped hole for cross connection	
  		  		  		  	
22-8 AWG 1.5-6 sq.mm 22-8 AWG		22-6 AWG 1.5-10 sq.mm 16-6 AWG		22-6 AWG 2.5-16 sq.mm 20-4 AWG		12-2 AWG 6-25 sq.mm 14-2 AWG	
600 V 750 V 600 V		600 V 750 V 600 V		600 V 800 V 600 V		600 V 750 V 600 V	
50 A 41 A 50 A		65 A 57 A 65 A		70 A 76 A 85 A		115 A 101 A 115 A	
9 lb-in 0.8 Nm 14 lb-in		14 lb-in 1.2 Nm 14 lb-in		14 lb-in 1.2 Nm 14 lb-in		25 lb-in 2.0 Nm 25 lb-in	
<b>Cat. No.</b>	<b>Std. Pk.</b>	<b>Cat. No.</b>	<b>Std. Pk.</b>	<b>Cat. No.</b>	<b>Std. Pk.</b>	<b>Cat. No.</b>	<b>Std. Pk.</b>
CTS6U	100	CTS10U	100	CTS16U	50	CTS25U	50
EP6/10U	50	EP6/10U	50			EP25U	50
PP6/10U	50	PP6/10U	50			PP25U	50
SP6/10U	100	SP6/10U	100	SP6/10U	100		
							
CA702	50	CA702	50	CA702	50	CA702	50
CA802	50	CA802	50	CA802	50	CA802	50
CA723/2	100	CA724/2	100	CA751/2	50	CA725/2	50
CA723/3	50	CA724/3	50	CA751/3	50	CA725/3	25
CA723/4	50	CA724/4	50	CA751/4	50	CA725/4	25
CA723/10	10	CA724/10	10	CA751/10	10	CA725/10	10
CA743/2	100	CA744/2	100	CA761/2	50	CA745/2	50
CA743/3	50	CA744/3	50	CA761/3	50	CA745/3	25
CA743/4	50	CA744/4	50	CA761/4	50	CA745/4	25
CA743/10	10	CA744/10	10	CA761/10	10	CA745/10	10
CA703/2	100	CA703/3	100	CA703/8	100	CA703/4	100
CA704/2	100	CA704/3	100	CA704/8	100	CA704/4	100
CA705/2	100	CA705/3	100	CA705/8	100	CA705/4	100
CA733/10	100	CA734/10	100	CA739/10	100	CA735/10	100
CA707/S/Q/1	100	CA707/S/Q/1	100	CA707/S/Q/5	100	CA707/S/Q/2	100
CA710/2	100	CA718/2	100				
CA710/3	100	CA718/3	50				
CA710/4	100	CA718/4	50				
CA710/10	25	CA718/10	25				
MT8	100	MT10	100	MT12	100	MT12	100
SWL6	100						

	CTS35U			CTS50U			CTS95U		
					AEx eII EEx eII				
Terminal Width	15 mm			20.5 mm			25 mm		
Height x Length	58 x 52.5 mm			75.5 x 71 mm			90 x 83 mm		
Stripping Length	18 mm			22 mm			24 mm		
Insulation Material	Polyamide 6.6			Polyamide 6.6			Polyamide 6.6		
Type of Connection	2 screw clamps & 1 tapped hole for cross connection			2 screw clamp connections			2 Allen screw clamp connections		
Approvals									
Wire Range	8-2 AWG	10-35 sq.mm	8-2 AWG	6-2/0 AWG	16-50 sq.mm	6-2/0 AWG	2-4/0 AWG	16-95 sq.mm	2-4/0 AWG
Voltage Rating	600 V	750 V	600 V	600V	1000 V	600 V	600V	1000 V	600 V
Current Rating	145 A	125 A	145 A	150 A	150 A	150 A	230 A	232 A	230 A
Torque	25 lb-in	2.5 Nm	25 lb-in	60 lb-in	6.8 Nm	60 lb-in	160 lb-in	18.2 Nm	160 lb-in
Terminal Block	Cat. No. CTS35U	Std. Pk. 50		Cat. No. CTS50U	Std. Pk. 20		Cat. No. CTS95U	Std. Pk. 10	
End Plate	EP35U	50							
Isolation Partition	PP35U	50							
Separator Plate									
DIN Rail <i>for ordering information refer to page 62</i>									
End Stop <i>for ordering information refer to page 63</i>		CA702 CA802	50 50	CA202 CA102	50 50	CA202 CA102	50 50	CA202 CA102	50 50
Internal Jumper 	CA726/2 CA726/3 CA726/4 CA726/10	50 25 25 10							
Insulated Internal Jumper 	CA746/2 CA746/3 CA746/4 CA746/10	50 25 25 10							
Current Bars 	CA703/5 CA704/5 CA705/5 CA736/10	100 100 100 100							
Shorting Sleeve & Screw 	CA707/S/Q/2	100							
Marking Tags 	MT15	100		MT20	100		MT25	100	



## FEED-THROUGH MULTI-CONNECTION 35 or 32mm DIN Rail

Connect multiple wires to a single terminal block and eliminate reliability problems encountered when connecting two wires into a single clamp. Two versions are available.

Type CMC1-2 features a single screw-cage clamp for 22-10 AWG wires on one side and two clamps on the other side for 22-10 AWG wires.

Type CMC2-2 has two identical clamps for 22-10 AWG wires on both sides.

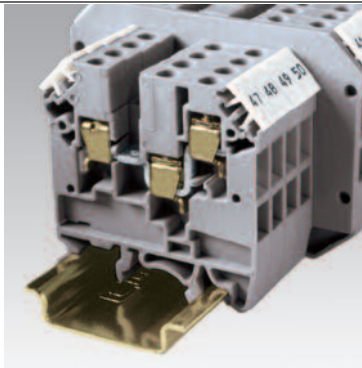

	CMC1-2			CMC2-2		
Terminal Width	6 mm			6 mm		
Height x Length	47 x 46.5 mm			51.5 x 65 mm		
Stripping Length	9 mm			9 mm		
Insulation Material	Polyamide 6.6			Polyamide 6.6		
Type of Connection	3 screw clamps & 1 tapped hole for cross connection			4 screw clamps & 2 tapped holes for cross connection		
Approvals						
Wire Range	22-10AWG	0.5-4 sq.mm	22-10 AWG	22-10 AWG	0.5-4 sq.mm	22-10 AWG
Voltage Rating	600 V	600 V	600 V	600 V	600 V	600 V
Current Rating	35 A	32 A	35 A	35 A	32 A	35 A
Torque	7 lb-in.	0.5 Nm	7 lb-in.	7 lb-in.	0.5 Nm	7 lb-in.
	<b>Cat. No.</b>	<b>Std. Pk.</b>		<b>Cat. No.</b>	<b>Std. Pk.</b>	
Terminal Block	CMC1-2	100		CMC2-2	50	
End Plate	EPCMC1-2	50		EPCMC2-2	50	
DIN Rail <i>for ordering information refer to page 62</i>						
End Stop <i>for ordering information refer to page 63</i>						
Internal Jumper	2 pole	CA722/2	100	CA722/2	100	
	3 pole	CA722/3	50	CA722/3	50	
	4 pole	CA722/4	50	CA722/4	50	
	10 pole	CA722/10	10	CA722/10	10	
	100 pole	CA722/100	5	CA722/100	5	
Insulated Internal Jumper	2 pole	CA742/2	100	CA742/2	100	
	3 pole	CA742/3	50	CA742/3	50	
	4 pole	CA742/4	50	CA742/4	50	
	10 pole	CA742/10	10	CA742/10	10	
	100 pole	CA742/100	5	CA742/100	5	
Current Bars	2 pole	CA703/1	100	CA703/1	100	
	3 pole	CA704/1	100	CA704/1	100	
	4 pole	CA705/1	100	CA705/1	100	
	10 pole	CA732/10	100	CA732/10	100	
	10 pole (breakable)	CA732/10-A	100	CA732/10-A	100	
	100 pole	CA732/100	10	CA732/100	10	
Shorting Sleeve & Screw		CA707/S/Q/01	100	CA707/S/Q/01	100	
External Jumper	2 pole	CA713/2	100	CA713/2	100	
	3 pole	CA713/3	100	CA713/3	100	
<i>for use in upper level</i>	4 pole	CA713/4	50	CA713/4	50	
	10 pole	CA713/10	25	CA713/10	25	
Marking Tags (MTType)		MT6	100	MT6	100	



### COLOR BLOCKS (other than grey standard)

When ordering please add color suffix to Cat. No.

Example: CTS2.5U-N/R

Color	Ordering Suffix
Red	R
Blue	BU
Black	BL
Orange	O
Green	G
Yellow	Y
White	W
Beige	BG
Dark Brown	DB

## FEED-THROUGH DOUBLE LEVEL 35 or 32mm DIN Rail

Altech double level terminals are the answer to high wiring density problems posed by certain unavoidable wiring arrangements. Double level terminals have the following advantages:

- Double wiring density available without extension of mounting rails.
- Interconnection/shorting can be done at both levels.
- Marking/identification by marking tags possible at both levels.

CDL4U(I.S) internally shorted double level terminals are useful for distribution applications by using shorting links at lower levels.

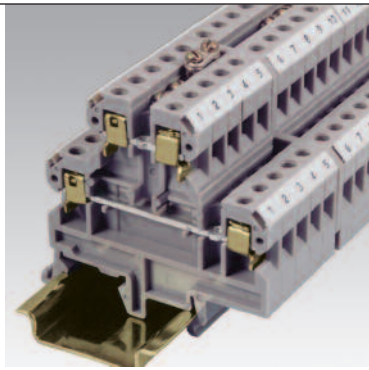

CDL4U

CDL4U(I.S)

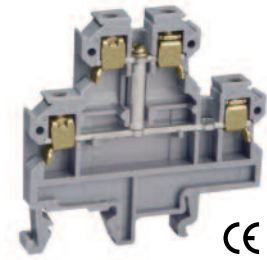
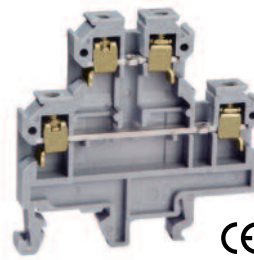

Terminal Width	6 mm			6 mm		
Height x Length	54 x 55.5 mm			54 x 55.5 mm		
Stripping Length	9 mm			9 mm		
Insulation Material	Polyamide 6.6			Polyamide 6.6		
Type of Connection	4 screw clamps & 2 tapped holes for cross connection			4 screw clamps & 1 tapped hole for cross connection		
Approvals						
Wire Range	22-10 AWG	0.5-4 sq.mm	22-10 AWG	22-10 AWG	0.5-4 sq.mm	22-10 AWG
Voltage Rating	300V	400 V	600 V	300 V	400 V	600 V
Current Rating	35 A	32 A	35 A	35 A	32 A	35 A
Torque	7 lb-in	0.5 Nm	7 lb-in	7 lb-in	0.5 Nm	7 lb-in
	<b>Cat. No.</b>	<b>Std. Pk.</b>		<b>Cat. No.</b>	<b>Std. Pk.</b>	
Terminal Block	CDL4U	100		CDL4U(I.S)	100	
End Plate	EPCDL4U	50		EPCDL4U	50	
Separator Plate	SPCDL4U	100		SPCDL4U	100	
DIN Rail <i>for ordering information refer to page 62</i>						
End Stop <i>for ordering information refer to page 63</i>			CA702	50	CA702	50
			CA802	50	CA802	50
Internal Jumper	2 pole	CA727/2	100	CA727/2	100	
	3 pole	CA727/3	50	CA727/3	50	
	4 pole	CA727/4	50	CA727/4	50	
	10 pole	CA727/10	10	CA727/10	10	
Insulated Internal Jumper	2 pole	CA747/2	100	CA747/2	100	
	3 pole	CA747/3	50	CA747/3	50	
	4 pole	CA747/4	50	CA747/4	50	
	10 pole	CA747/10	10	CA747/10	10	
Current Bars	2 pole	CA703/1	100	CA703/1	100	
	3 pole	CA704/1	100	CA704/1	100	
	4 pole	CA705/1	100	CA705/1	100	
	10 pole	CA732/10	100	CA732/10	100	
	10 pole (breakable)	CA732/10-A	100	CA732/10-A	100	
	100 pole	CA732/100	10	CA732/100	10	
Shorting Sleeve & Screw		CA607/S/Q	100	CA607/S/Q	100	
External Jumper	2 pole	CA714/2	100	CA714/2	100	
	3 pole	CA714/3	100	CA714/3	100	
	4 pole	CA714/4	50	CA714/4	50	
	10 pole	CA714/10	25	CA714/10	25	
Marking Tags (MTType)		MT2	100	MT2	100	



### COLOR BLOCKS

(other than grey standard)

When ordering please add color suffix to Cat. No.

Example: CTS2.5U-N/R

Color	Ordering Suffix
Red	R
Blue	BU
Black	BL
Orange	O
Green	G
Yellow	Y
White	W
Beige	BG
Dark Brown	DB

## FEED-THROUGH OFFSET DOUBLE LEVEL

Altech Offset Double Level Terminals, which provide a separate connection at two levels. In ODL, the top level is offset from the bottom level by half the thickness of the terminal. This offset provides better accessibility to the screws on the lower level.

\*It is recommended to use end plates at both ends of assembled ODL terminal sets for flat alignment to enable effective use of end stops.

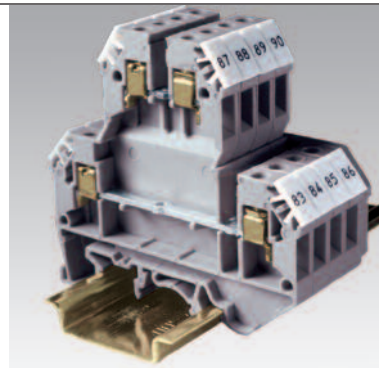

Terminal Width	6 mm		
Height x Length	63 x 68 mm		
Stripping Length	9 mm		
Insulation Material	Polyamide 6.6		
Type of Connection	4 screw clamps & 2 tapped holes for cross connection		
Approvals			
Wire Range	22-10 AWG	0.5-4 sq.mm	22-10 AWG
Voltage Rating	600 V	600 V	600 V
Current Rating	35 A	32 A	35 A
Torque	7 lb-in	0.5 Nm	7 lb-in

	Cat. No.	Std. Pk.
Terminal Block	ODL4U	50
End Plate* Front	EPODL4U	50
End Plate* Back	EP1ODL4U	50

DIN Rail <i>for ordering information refer to page 62</i>	
--	--

End Stop <i>for ordering information refer to page 63</i>		CA702	50
		CA802	50

Internal Jumper		2 pole	CA727/2	10
		3 pole	CA727/3	10
		4 pole	CA727/4	10
		10 pole	CA727/10	10

Insulated Internal Jumper		2 pole	CA747/2	100
		3 pole	CA747/3	50
		4 pole	CA747/4	50
		10 pole	CA747/10	10

Current Bars		2 pole	CA703/1	100
		3 pole	CA704/1	100
		4 pole	CA705/1	100
		10 pole	CA732/10	100
		10 pole (breakable)	CA732/10-A	100
		100 pole	CA732/100	10

Shorting Sleeve & Screw		CA607/S/Q	100
-------------------------	--	-----------	-----

External Jumper		2 pole	CA714/2	100
		3 pole	CA714/3	100
		4 pole	CA714/4	50
		10 pole	CA714/10	25

Marking Tags (MTType)		MT6	100
-----------------------	--	-----	-----



### COLOR BLOCKS

(other than grey standard)

When ordering please add color suffix to Cat. No.

Example: CTS2.5U-N/R

Color	Ordering Suffix
Red	R
Blue	BU
Black	BL
Orange	O
Green	G
Yellow	Y
White	W
Beige	BG
Dark Brown	DB

## FEED-THROUGH TRIPLE LEVEL 35 or 32mm DIN Rail

For applications with extreme space constraints. Only 6mm (.236") wide, with three separate feed-through levels. Jumpers can be used to reduce field wiring.

They can also be used in control systems where sensors and actuator applications are involved.

The top level of CTL2.5UH terminal block provide connecting points for signal while middle and bottom level provide connecting points are used for positive and negative potential.

In applications where switching indication is required, choice of CTL2.5UHL and CTL2.5UL terminal blocks with built-in electronic components are available.



### COLOR BLOCKS (other than grey standard)

When ordering please add color suffix to Cat. No.

Example: CTS2.5U-N/R

Color	Ordering Suffix
Red	R
Blue	BU
Black	BL
Orange	O
Green	G
Yellow	Y
White	W
Beige	BG
Dark Brown	DB

### CTL2.5U-H

### CTL2.5U

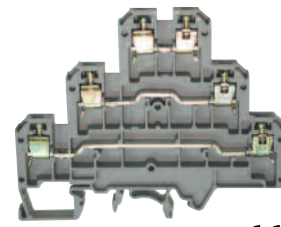
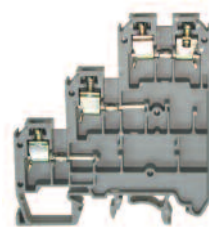

Terminal Width	6 mm			6 mm		
Height x Length	67 x 61 mm			67 x 84 mm		
Stripping Length	9 mm			9 mm		
Insulation Material	Polyamide 6.6			Polyamide 6.6		
Type of Connection	4 Screw clamps & 3 tapped holes for cross connection			6 Screw clamps & 3 tapped holes for cross connection		
Approvals						
Wire Range	22-12 AWG	0.5-2.5 sq.mm	22-12 AWG	22-12 AWG	0.5-2.5 sq.mm	22-12 AWG
Voltage Rating	300 V	500 V	300 V	300 V	500 V	300 V
Current Rating	25 A	24 A	25 A	25 A	24 A	25 A
Torque	4.5 lb-in	0.4 Nm	4.5 lb-in	4.5 lb-in	0.4 Nm	4.5 lb-in

		Cat. No.	Std. Pk.	Cat. No.	Std. Pk.	
Terminal Block		CTL2.5U-H	50	CTL2.5U	50	
End Plate		EPCTL2.5U-H	50	EPCTL2.5U	50	
DIN Rail	<i>for ordering information refer to page 62</i>					
End Stop	<i>for ordering information refer to page 63</i>		CA702 CA802	50 50	CA702 CA802	50 50
Internal Jumper		2 pole 3 pole 4 pole 10 pole 100 pole	CA722/2 CA722/3 CA722/4 CA722/10 CA722/100	100 50 50 10 5	CA722/2 CA722/3 CA722/4 CA722/10 CA722/100	100 50 50 10 5
Current Bars		2 pole 3 pole 4 pole 10 pole 10 pole (breakable) 100 pole	CA703/1 CA704/1 CA705/1 CA732/10 CA732/10-A CA732/100	100 100 100 100 100 10	CA703/1 CA704/1 CA705/1 CA732/10 CA732/10-A CA732/100	100 100 100 100 100 10
Shorting Sleeve & Screw			CA707/S/Q/01	100	CA707/S/Q/01	100
External Jumper		2 pole 3 pole 4 pole 10 pole	CA715/2 CA715/3 CA715/4 CA715/10	100 100 100 50	CA715/2 CA715/3 CA715/4 CA715/10	100 100 100 50
Marking Tags (MTType)			MT2	100	MT2	100

## CTL2.5U-H(L)\*

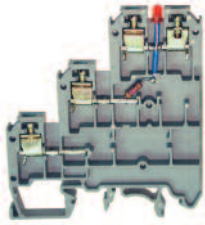

## CTL2.5U(L)\*

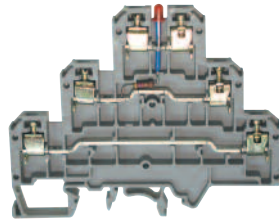

6 mm

67 x 61 mm

9 mm

Polyamide 6.6

4 Screw clamps & 2 tapped holes for cross connection



22-12 AWG 0.5-2.5 sq.mm 22-12 AWG

300 V

500 V

300 V

25 A

24 A

25 A

4.5 lb-in

0.4 Nm

4.5 lb-in

6 mm

67 x 84 mm

9 mm

Polyamide 6.6

6 Screw clamps & 2 tapped holes for cross connection



22-12 AWG 0.5-2.5 sq.mm 22-12 AWG

300 V

500 V

300 V

25 A

24 A

25 A

4.5 lb-in

0.4 Nm

4.5 lb-in

Cat. No.

Std. Pk.

CTL2.5U-H(L)\*

50

EPCTL2.5U-H

50

Cat. No.

Std. Pk.

CTL2.5U(L)\*

50

EPCTL2.5U

50

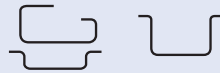
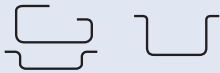

CA702  
CA802

50  
50

CA702  
CA802

50  
50

CA722/2  
CA722/3  
CA722/4  
CA722/10  
CA722/100

100  
50  
50  
10  
5

CA722/2  
CA722/3  
CA722/4  
CA722/10  
CA722/100

100  
50  
50  
10  
5

CA703/1  
CA704/1  
CA705/1  
CA732/10  
CA732/10-A  
CA732/100

100  
100  
100  
100  
100  
10

CA703/1  
CA704/1  
CA705/1  
CA732/10  
CA732/10-A  
CA732/100

100  
100  
100  
100  
100  
10

CA707/S/Q/01

100

CA707/S/Q/01

100

CA715/2  
CA715/3  
CA715/4  
CA715/10

100  
100  
100  
50

CA715/2  
CA715/3  
CA715/4  
CA715/10

100  
100  
100  
50

MT2

100

MT2

100

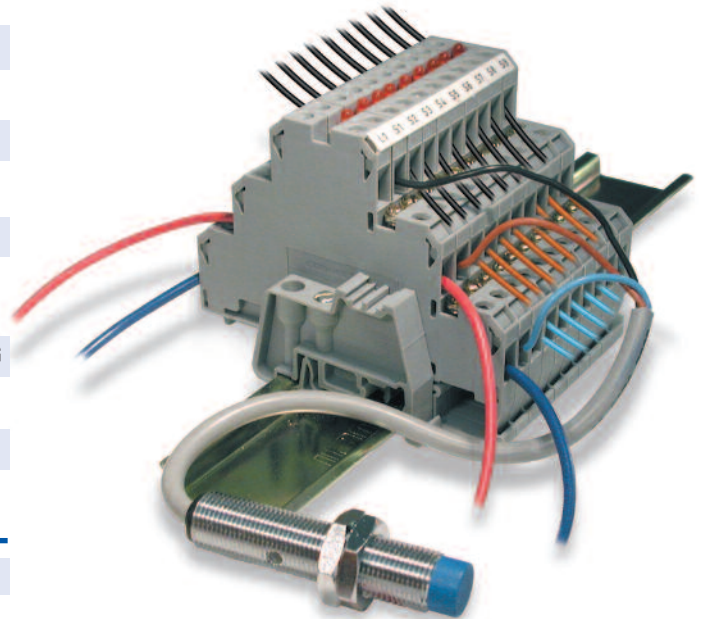

*Ideal for sensor applications.  
See Altech's Inductive Proximity Sensor catalog for ordering information.*

\* Add required voltage to part number as suffix;  
i.e. CTL2.5U(L)/24 for 24V DC



## DISTRIBUTION BLOCK

Altech CDB Compact Distribution Blocks are an ideal choice for a simplified distribution system. A lug/bolt secures the incoming cable and the screw clamp design of the block provides the outgoing connections. These provide easy connect points and ensure perfect continuity for distribution. A protective shield effectively shrouds the incoming connection.

### Application Information:

Sum of outgoing currents on either side of center should not exceed half the maximum permissible incoming current.

Sum of total outgoing currents should not exceed maximum permissible incoming current.

Connection for higher outgoing currents should be done through the terminal nearest to the incoming connection.

CMDB blocks are the modified version of CDB terminal blocks without central incoming terminal connections.



### COLOR BLOCKS

(other than grey standard)

When ordering please add color suffix to Cat. No.

Example: CTS2.5U-N/R

Color	Ordering Suffix
Red	R
Blue	BU
Black	BL
Orange	O
Green	G
Yellow	Y
White	W
Beige	BG
Dark Brown	DB

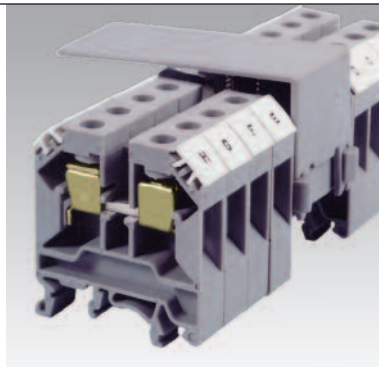

### CDB4

### CDB4(1)

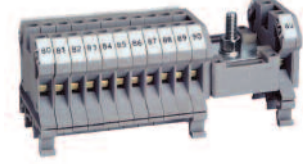
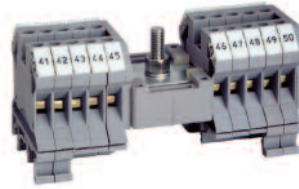

Terminal Width	6 mm			6 mm			
Height & Width	45 x 43 mm			45 x 43 mm			
Stripping Length	9 mm			9 mm			
Insulation Material	Polyamide 6.6			Polyamide 6.6			
Type of Connection	Input	1 Lug/ M5 bolt connection for ring lug			1 Lug M5 /bolt connection for ring lug		
	Output	Screw clamp connection			Screw clamp connection		
Approvals							
Wire Range	Input	10-8 AWG	6-16 sq.mm	10-8 AWG	10-8 AWG	6-16 sq.mm	10-8 AWG
	Output	22-12 AWG	0.5-4 sq.mm	22-10 AWG	22-12 AWG	0.5-4 sq.mm	22-10 AWG
Voltage Rating	600 V		750 V	600 V	600 V	750 V	600 V
Current Rating	Input	50 A		50 A	50 A		50 A
	Max. Individual Output	25 A	32 A	35 A	25 A	32 A	35 A
Torque	Input	26 lb-in	2.0 Nm	26 lb-in	26 lb-in	2.0 Nm	26 lb-in
	Output	7 lb-in	0.5 Nm	7 lb-in	7 lb-in	0.5 Nm	7 lb-in

Terminal Block	Cat. No.	H x W x L (mm)	Outputs	Std.Pk.	Cat. No.	H x W x L (mm)	Outputs	Std.Pk.
	CDB4/1	45 x 43 x 43.8	4	10	CDB4/2(1)	45 x 43 x 52	4	10
	CDB4/2	45 x 43 x 55.8	8	10	CDB4/3(1)	45 x 43 x 58	6	10
	CDB4/3	45 x 43 x 67.8	12	10	CDB4/4(1)	45 x 43 x 64	8	5
	CDB4/4	45 x 43 x 80	16	5	CDB4/5(1)	45 x 43 x 70	10	5
	CDB4/5	45 x 43 x 96	20	5	CDB4/6(1)	45 x 43 x 76	12	5
					CDB4/10(1)	45 x 43 x 100	20	5
					CDB4/11(1)	45 x 43 x 106	22	5

Cat. No.

Std. Pk.

Cat. No.

Std. Pk.

DIN Rail  
for ordering information refer to page 62

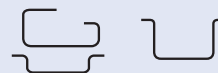

End Stop  
for ordering information refer to page 63



CA702  
CA802

50  
50

CA702  
CA802

50  
50

Marking Tags (MTType)



MT6

100

MT6

100

Warning Label

## CDB6



8 mm

43 x 47 mm

12 mm

Polyamide 6.6

1 Lug/ M6 bolt connection for ring lug

Screw clamp connection



10-6 AWG  
22-8 AWG

6-25 sq.mm  
1.5-6 sq.mm

10-2 AWG  
22-8 AWG

600 V

750 V

600 V

100 A  
50 A

41 A

100 A  
50 A

25 lb-in  
9 lb-in

3.0 Nm  
0.8 Nm

35 lb-in  
14 lb-in

## CDB10



10 mm

43 x 47 mm

12 mm

Polyamide 6.6

1 Lug/ M8 bolt connection for ring lug

Screw clamp connection



7-2 AWG  
15-7 AWG

10-35 sq.mm  
1.5-10 sq.mm

8-1/0 AWG  
22-6 AWG

600 V

750 V

600 V

125 A  
65 A

57 A

130 A  
65 A

53 lb-in  
14 lb-in

6.0 Nm  
1.2 Nm

53 lb-in  
14 lb-in

## CMDB4



6 mm

45 x 43 mm

9 mm

Polyamide 6.6

Screw clamp connection

22-10 AWG

0.5-4 sq.mm

22-10 AWG

600 V

800 V

600 V

35 A

32 A

35 A

7 lb-in

0.5 Nm

7 lb-in

Cat. No.	H x W x L (mm)	Outputs	Std.Pk
CDB6/2	43 x 47 x 64	8	10
CDB6/3	43 x 47 x 80	12	10
CDB6/4	43 x 47 x 96	16	5

Cat. No.	H x W x L (mm)	Outputs	Std.Pk
CDB10/2	43 x 47 x 72	8	10
CDB10/3	43 x 47 x 92	12	10
CDB10/4	43 x 47 x 112	16	5

Cat. No.	H x W x L (mm)	Outputs	Std.Pk
CMDB4/2	45 x 43 x 13.5	4	10
CMDB4/3	45 x 43 x 19.5	6	10
CMDB4/4	45 x 43 x 25.5	8	5
CMDB4/10	45 x 43 x 61.5	20	5

Cat. No. Std. Pk.

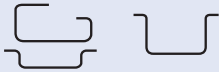

CA702  
CA802

50  
50

Cat. No. Std. Pk.

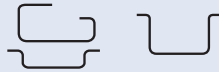

CA702  
CA802

50  
50

Cat. No. Std. Pk.

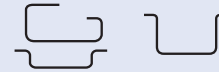

CA702  
CA802

50  
50

MT8 100

SWL6 100

MT10 100

MT6 100

**CMDB6**

**CMDB10**



Terminal Width	8 mm			10 mm				
Height & Width	43 x 47 mm			43 x 47 mm				
Stripping Length	12 mm			12 mm				
Insulation Material	Polyamide 6.6			Polyamide 6.6				
Type of Connection	Input	Screw clamp connection			Output	Screw clamp connection		
Approvals								
Wire Range	Input	22-8 AWG	1.5-6 sq.mm	22-8 AWG	Output	15-7 AWG	1.5-10 sq.mm	20-6 AWG
Voltage Rating		600 V	800 V	600 V		600 V	800 V	600 V
Current Rating	Max. Individual	50 A	41 A	50 A	Output	65 A	57 A	65 A
Torque	Input	9 lb-in	0.8 Nm	14 lb-in	Output	14 lb-in	1.2 Nm	14 lb-in

Terminal Block	Cat. No.	H x W x L (mm)	Outputs	Std. Pk	Cat. No.	H x W x L (mm)	Outputs	Std. Pk
		CMDB6/2	43 x 48 x 17.5	4	10	CMDB10/2	43 x 48 x 21.5	4
	CMDB6/3	43 x 48 x 25.5	6	10	CMDB10/3	43 x 48 x 31.5	6	10
	CMDB6/4	43 x 48 x 33.5	8	10	CMDB10/4	43 x 48 x 41.5	8	10
	CMDB6/10	43 x 48 x 81.5	20	5	CMDB10/10	43 x 48 x 101.5	20	5

DIN Rail <i>for ordering information refer to page 62</i>	Cat. No.	Std. Pk.	Cat. No.	Std. Pk.
End Stop <i>for ordering information refer to page 63</i>	CA702	50	CA702	50
	CA802	50	CA802	50

Marking Tags (MT Type)	Cat. No.	Std. Pk.	Cat. No.	Std. Pk.
		MT8	100	MT10
Warning Label	SWL6	100		

**COLOR BLOCKS**  
(other than grey standard)

When ordering please add color suffix to Cat. No.  
*Example: CTS2.5U-N/R*

Color	Ordering Suffix
Red	R
Blue	BU
Black	BL
Orange	O
Green	G
Yellow	Y
White	W
Beige	BG
Dark Brown	DB



## ONE PHASE POWER DISTRIBUTION BLOCKS

- Speed of mounting and wiring
- IP20 Finger Safe
- DIN Rail or Panel Mount
- Blocks fit with other DIN Rail mountable modular devices (height 95mm, depth 44.5mm)
- Accessories increase the number of outputs with only one input.

38049

38041



Part Number:

White

**38049** (UL File E98082)

**38041** (UL File E98082)

Gray

**DB16** (UL File E220514)

**DB35** (UL File E220514)

Approvals



Current Rating

80A

80A

115A

125A

Voltage Rating

600V AC

690V AC

600V AC

690V AC

No. of Inputs

1

1

1

1

Wire Range

8-4 AWG

6-16mm<sup>2</sup>

8-2 AWG

10-35mm<sup>2</sup>

Torque

13.5lb.-in.

1.5Nm

31lb.-in.

3.5Nm

(40 for DB35)

Screw Type

Pozi Drive 2

Pozi Drive 2

No. of Outputs

6

6

6

6

Wire Range

(2x)8-4 AWG

(2x)6-16mm<sup>2</sup>

14-6 AWG

2.5-16mm<sup>2</sup>

Torque

13.5lb.-in.

1.5Nm

17.5lb.-in.

2Nm

Wire Range

(4x)14-10 AWG

(4x)2.5-6mm<sup>2</sup>

Torque

7.2lb.-in.

0.8Nm

Screw Type

Pozi Drive 2

Pozi Drive 2

Optional

Marking Tag

MT2

MT2

(for DB16 and DB35)

Dimensions:

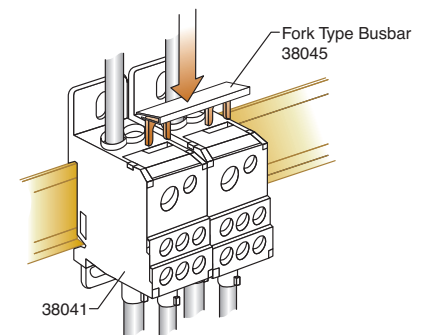
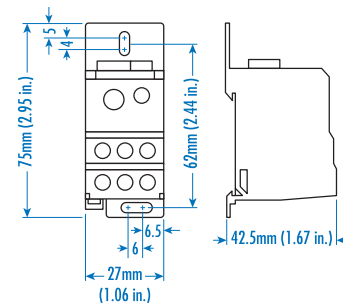
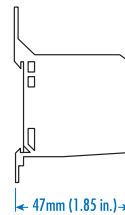
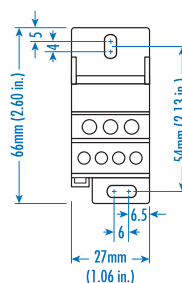

Accessories Fork Type Busbar  
Part Number: **38045** to jump 2 Blocks  
**38046** to jump 8 Blocks  
can be cut to customer needs

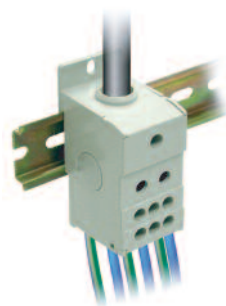
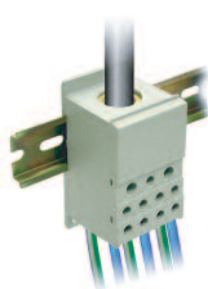
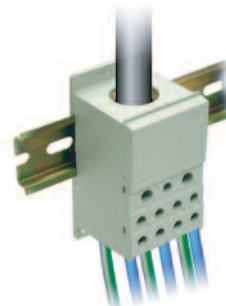
**38032****38020****38019**

Part Number:

**38032****38020****38019**

Approvals



Current Rating

160A

160A

230A

250A

310A

400A

Voltage Rating

600V AC

690V AC

600V AC

690V AC

600V AC

690V AC

No. of Inputs

1

1

1

1

1

1

Wire Range

8-2/0AWG

10-70mm<sup>2</sup>

2-4/0AWG

35-120mm<sup>2</sup>

3/0-350kcmil

95-185mm<sup>2</sup>

Torque

35.5lb. in.

4Nm

170lb. in.

19Nm

230lb. in.

25Nm

No. of Outputs

6

6

11

11

11

11

Wire Range

14-6 AWG

2.5-16mm<sup>2</sup>

2x 14-2AWG

2.5-35mm<sup>2</sup>

2x 14-2AWG

2.5-35mm<sup>2</sup>

Torque

17.5lb. in.

2Nm

31lb. in.

3.5Nm

31lb. in.

3.5Nm

Wire Range

14-6 AWG

2.5-16mm<sup>2</sup>

5x 14-6AWG

2.5-16mm<sup>2</sup>

5x 14-6AWG

2.5-16mm<sup>2</sup>

Torque

17.5lb. in.

2Nm

17.5lb. in.

2Nm

17.5lb. in.

2Nm

Wire Range

4x 14-8AWG

2.5-10mm<sup>2</sup>

4x 14-8AWG

2.5-10mm<sup>2</sup>

4 x 14-8AWG

2.5-10mm<sup>2</sup>

Torque

17.5lb. in.

2Nm

17.5lb. in.

2Nm

17.5lb. in.

2Nm

Dimensions:

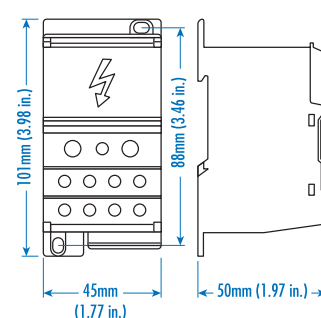
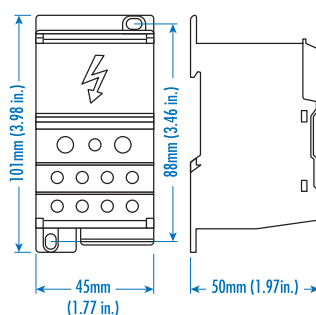
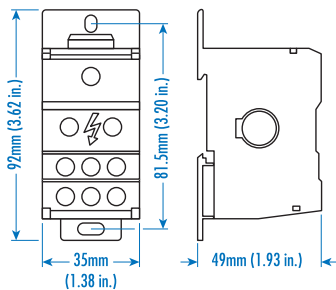
Accessories  
Part Number:

Copper Jumper Bar  
**3803221** for 2 Blocks  
**3803231** for 3 Blocks  
**3803241** for 4 Blocks  
 can be cut to customer needs

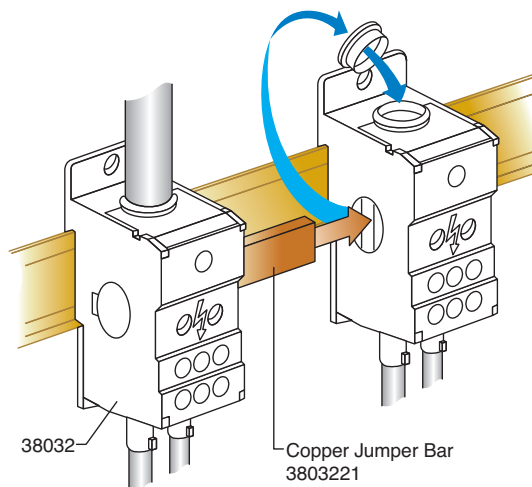
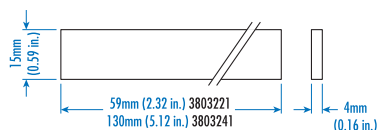

## THREE PHASE POWER DISTRIBUTION BLOCKS

38075

38073

- Speed of mounting and wiring
- IP20 Finger Safe
- DIN Rail or Panel Mount
- Blocks fit with other DIN Rail mountable modular devices
- Same compact size for both ratings

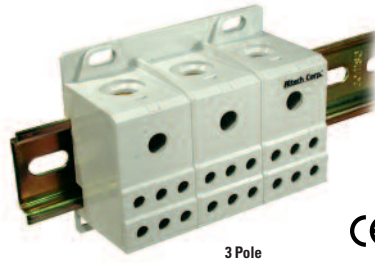

3 Pole

Part Number:

**38075**

**38073**

Approvals



	38075		38073	
Current Rating	115A	115A	175A	175A
Voltage Rating	600V AC	690V AC	600V AC	690V AC
No. of Inputs	3x1	3x1	3x1	3x1
Wire Range	8-2AWG	10-35mm <sup>2</sup>	8-2/0AWG	10-70mm <sup>2</sup>
Torque	31lb. in.	3.5Nm	35.5lb. in.	4Nm
No. of Outputs	3x6	3x6	3x6	3x6
Wire Range	14-4AWG	2.5-16mm <sup>2</sup>	14-4AWG	2.5-16mm <sup>2</sup>
Torque	17.5lb. in.	2Nm	17.5 lb. in.	2Nm

Dimensions:

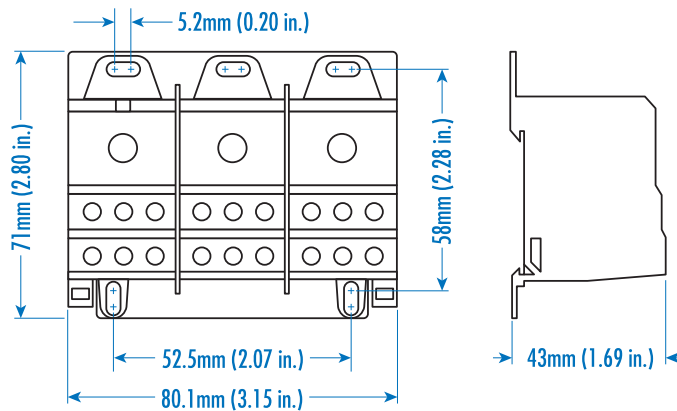

## GROUND

### 35 and 32mm DIN Rail

Use ground blocks instead of grounding studs and wire lugs to terminate ground wires, saving installation and wiring time.

Ground blocks clamp mechanically onto the DIN Rail by tightening the center mounting screw, making a reliable electrical connection between the cage clamp terminals and the DIN Rail. The rail serves as a busbar and automatically distributes ground potential to all other ground terminals on the same rail.

Ground blocks can also be used as end stops, preventing other terminal blocks and components from moving laterally on the DIN Rail.

They are supplied with a standard green/yellow housing for easy identification and accept standard marking tags.

CGT4U, CGT10U and CGT35U can be mounted on both DIN 32mm and DIN 35mm rails.

CGT4N & CGT6N can be mounted on 35mm DIN rail and have the same top outer profile as the feed through blocks (CTS4U-N, CTS2.5U-N, CTS6U, CTS10U).

CGMT4 can be mounted on 15mm DIN rails and has the same top outer profile as the CMT4 feed through blocks.

- High density
- Screw-cage clamp
- Special clamping foot
- Polyamide 6.6
- Color: green/yellow

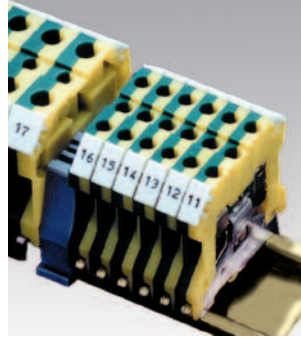

Terminal Width

Height x Length

Stripping Length

Insulation Material

Type of Connection

Approvals

Wire Range

Torque

CGT4U



AEx eII EEx eII

6 mm

48 x 43 mm

9 mm

Polyamide 6.6

2 screw clamps



22-10 AWG 0.5-4 sq.mm 22-10 AWG

7 lb-in

0.5 Nm

7 lb-in

CGT4N



CE

6 mm

45.4 x 54.2 mm

9 mm

Polyamide 6.6

2 screw clamps



22-10 AWG 0.5-4 sq.mm 22-10 AWG

7 lb-in

0.8 Nm

7 lb-in

Terminal Block

DIN Rail  
for ordering information  
refer to page 62

End Plate



Marking Tags  
(MT Type)



Cat. No.

Std. Pk.

CGT4N

50

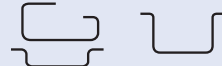

EPCGT4U

100

MT6

100

Cat. No.

Std. Pk.

CGT4N

50

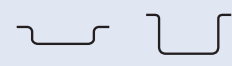

EPCGT4U

100



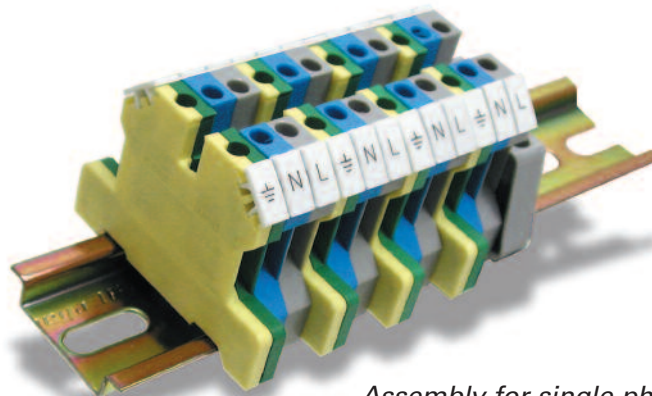

MT6

100

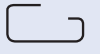

Assembly for single phase  
3 wire circuits.

CGT6N	CGT10U	CGT35U	CGMT4
			
CE	CE Ex AEx eII EEx eII	CE	CE
8 mm	10 mm	16 mm	6 mm
47 x 54.5 mm	49.5 x 45 mm	61.5 x 58 mm	28.5 x 27 mm
12 mm	12 mm	18 mm	9 mm
Polyamide 6.6	Polyamide 6.6	Polyamide 6.6	Polyamide 6.6
2 screw clamps	2 screw clamps	2 screw clamps	2 screw clamps
  	  	  	  
22-8 AWG 1.5-6 sq.mm 22-8 AWG	22-6 AWG 1.5-10 sq.mm 16-8 AWG	8-2 AWG 10-35 sq.mm 8-2 AWG	22-10 AWG 0.5-4 sq.mm 22-10 AWG
14 lb-in 0.8 Nm 14 lb-in	14 lb-in 1.2 Nm 14 lb-in	25 lb-in 2.5 Nm 25 lb-in	7 lb-in 0.5 Nm 7 lb-in

Cat. No.	Std. Pk.	Cat. No.	Std. Pk.	Cat. No.	Std. Pk.	Cat. No.	Std. Pk.
CGT6N	50	CGT10N	50	CGT35N	20	CGMT4	50
							
EPCGT4U	100	EPCGT4U	100	EPCGT4U	100	EPCGT4U	100
MT8	100	MT10	100	MT15	100	MT2	100



## DISCONNECT

### 35 or 32mm DIN Rail

Disconnect and test terminals are an ideal choice for measuring control and regulatory circuits. The terminals provide a clear functional advantage for devices having utility instruments and associated transformers.

Five versions of disconnect and test terminals are available:

- CDTTU - disconnection is achieved by means of a slide link operated with a screw driver.
- CDTTU-SH - disconnect and test terminals are ideal for use in current transformer applications when it is mandatory to keep the secondary side shorted at any point while taking current measurements.
- CKT4U - disconnection is achieved by lifting the knife contact lever.
- CSDL4U - hinged disconnection and testing terminal, incorporates a connecting link in place of the fuse link.
- CSDL6U - hinged disconnect block for 8 AWG size wires.
- DDDL4U - double level disconnect terminal with hinged disconnect in upper level.

Specially designed socket head screws act as test/monitoring points in both CDTTU, CDTTU-SH and CKT4U.

**Important:** The disconnecting device is not suitable for interrupting load. The supply must be switched off before operating the slide link/lever.

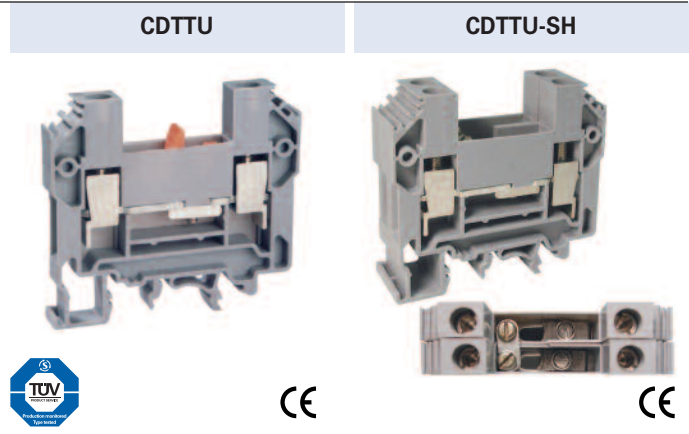
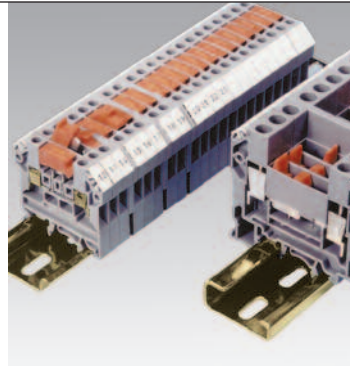

Terminal Width	8 mm			16 mm		
Height x Length	57 x 63 mm			57 x 63 mm		
Stripping Length	12 mm			12 mm		
Insulation Material	Polyamide 6.6			Polyamide 6.6		
Type of Connection	2 screw clamps			4 screw clamps		
Approvals						
Wire Range	16-8 AWG	1.5-6 sq.mm	16-8 AWG	16-8 AWG	1.5-6 sq.mm	16-8 AWG
Voltage Rating	600 V	750 V	600 V	300 V	300 V	600 V
Current Rating	41 A	41 A	41 A	10 A	10 A	10 A
Torque	14 lb-in	1.2 Nm	14 lb-in	14 lb-in	1.6 Nm	14 lb-in

		Cat. No.	Std. Pk.	Cat. No.	Std. Pk.	
Terminal Block		CDTTU	50	CDTTU-SH	50	
End Plate		EPCDTTU	50	EPCDTTU	50	
Isolation Partition						
DIN Rail	for ordering information refer to page 62					
End Stop	for ordering information refer to page 63	CA702 CA802	50 50	CA702 CA802	50 50	
External Jumper	for internal jumpers refer to page 60	2 pole 3 pole 4 pole 10 pole	CA710/2 CA710/3 CA710/4 CA710/10	100 100 100 25	CA710/2 CA710/3 CA710/4 CA710/10	100 100 100 25
Marking Tags	(MT Type) (MT Type on Lever)		MT8	100	MT8	100







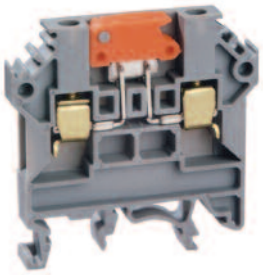
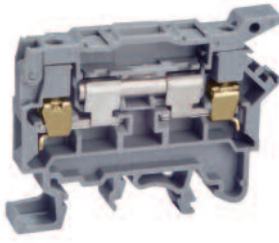
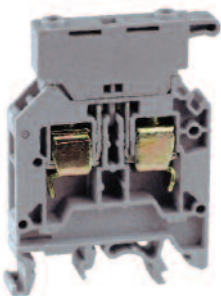

**COLOR BLOCKS**  
(other than grey standard)

**When ordering please add color suffix to Cat. No.**

**Example: CTS2.5U-N/R**

Color	Ordering Suffix
Red	R
Blue	BU
Black	BL
Orange	O
Green	G
Yellow	Y
White	W
Beige	BG
Dark Brown	DB

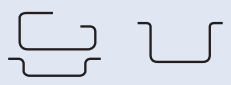
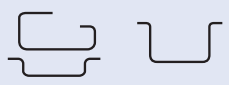
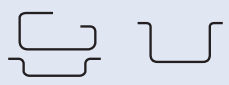
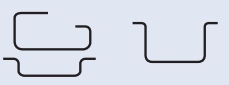

CKT4U			CSDL4U			CSDL6U			DDDL4U	
										
CE			CE			CE			CE	
6 mm			8 mm			8 mm			8 mm	
46 x 46.3 mm			43 x 58 mm			60 x 43 mm			66 x 88 mm	
9 mm			9.5 mm			9.5 mm			9.5 mm	
Polyamide 6.6			Polyamide 6.6			Polyamide 6.6			Polyamide 6.6	
2 screw clamps			2 screw clamps			2 screw clamps			4 screw clamps	
  			 							
22-10 AWG	0.5-4 sq.mm	22-10 AWG	22-10 AWG	0.5-4 sq.mm	22-10 AWG	22-8 AWG	1.5-6 sq.mm	22-8 AWG	22-10 AWG	22-10 AWG
600 V	750 V	600 V	600 V	750 V	600 V	300 V	500 V	300 V	600 V	300 V
16 A	16 A	16 A	14 A	6.3 A	14 A	10 A	6.3 A	10 A	14 / 35 A	14 / 35 A
7 lb-in	0.5 Nm	7 lb-in	7 lb-in	0.5 Nm	7 lb-in	14 lb-in	0.8 Nm	14 lb-in	7 lb-in	7 lb-in
<b>Cat. No.</b>	<b>Std. Pk.</b>	<b>Cat. No.</b>	<b>Std. Pk.</b>	<b>Cat. No.</b>	<b>Std. Pk.</b>	<b>Cat. No.</b>	<b>Std. Pk.</b>	<b>Cat. No.</b>	<b>Std. Pk.</b>	
CKT4U	50	CSDL4U	100	CSDL6U	50	DDDL4U	20			
EPCKT4U	50	EPCSFL4U	50	EPCSFL6U	50	EPDDL4U	25			
		PPCSFL4U	50							
										
CA702	50	CA702	50	CA702	50	CA702	50			
CA802	50	CA802	50	CA802	50	CA802	50			
CA713/2	100	CA711/2	100	CA710/2	100	CA711/2	100			
CA713/3	100	CA711/3	100	CA710/3	50	CA711/3	100			
CA713/4	50	CA711/4	50	CA710/4	50	CA711/4	50			
CA713/10	25	CA711/10	25	CA710/10	25	CA711/10	25			
MT6	100	MT8	100	MT8	100	MT8	100			
		MT2	100			MT2	100			

## FUSE BLOCKS

Certain electrical and control systems require protection by fuses. CSFL4U and CSFL6U have a specially designed space for cartridge type glass fuse and accept Ø5 x 20 or Ø5 x 25 mm fuses. CAFL4U accepts Ø1/4 x 1-1/4 in. fuses. The fuse can be engaged or disengaged by the movement of the carrier.

Altech fuse terminals are also available with light indication - CSFL4U(L). A specially designed built-in circuit gives light indication in the event of fuse blow out. Thus, fault in a circuit can be easily located.









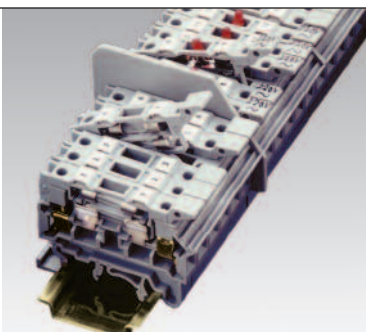



However, an application of such terminals must take into consideration residual current flow.

CAFL4U(L) is equipped with a LED for blown fuse indication. CAFL4U(N) is equipped with a neon bulb for same application.

**Important:** The disconnecting device is not suitable for interrupting load. The supply must be switched off before operating the slide link/lever.

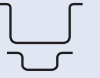
† Fuses are sold separately Altech, see page 34 for details.











	CSFL4U			CSFL4U(L)*		
Terminal Width	8 mm			8 mm		
Height x Length	43 x 58 mm			43 x 58 mm		
Stripping Length	9.5 mm			9.5 mm		
Insulation Material	Polyamide 6.6			Polyamide 6.6		
Type of Connection	2 screw clamps			2 screw clamps		
Fusion Voltage				24V AC/DC, 48V AC/DC, 110V AC/DC, 220V AC		
Type of Fuse Used	Ø5x20, Ø5x25 mm			Ø5x20, Ø5x25 mm		
Approvals						
Wire Range	22-10 AWG	0.5-4 sq.mm	22-10 AWG	22-10 AWG	0.5-4 sq.mm	22-10 AWG
Voltage Rating	600 V	750 V	600 V	600 V	750 V	600 V
Current Rating	16 A	6.3 A	8 A	6.3 A	6.3 A	8 A
Torque	7 lb-in	0.5 Nm	7 lb-in	7 lb-in	0.5 Nm	7 lb-in
	<b>Cat. No.</b>	<b>Std. Pk.</b>		<b>Cat. No.</b>	<b>Std. Pk.</b>	
Terminal Block	CSFL4U	100		CSFL4U(L)*	50	
End Plate 	EPCSFL4U	50		EPCSFL4U	50	
Isolation Partition 	PPCSFL4U	50		PPCSFL4U	50	
DIN Rail <i>for ordering information refer to page 62</i>	 		 			
End Stop <i>for ordering information refer to page 63</i> 	CA702	50		CA702	50	
	CA802	50		CA802	50	
External Jumper 2 pole 3 pole 4 pole 10 pole 	CA711/2	100		CA711/2	100	
	CA711/3	100		CA711/3	100	
	CA711/4	50		CA711/4	50	
	CA711/10	25		CA711/10	25	
Marking Tags (MT Type)  (MT Type on Lever)	MT8	100		MT8	100	
	MT2	100		MT2	100	

**COLOR BLOCKS**  
(other than grey standard)









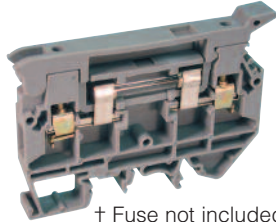
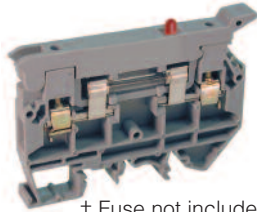
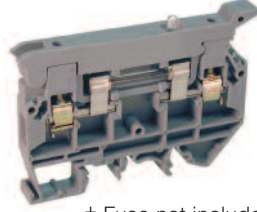

When ordering please add color suffix to Cat. No.

Example: CTS2.5U-N/R

Color	Ordering Suffix	
Red	R	
Blue	BU	
Black	BL	
Orange	O	
Green	G	
Yellow	Y	
White	W	
Beige	BG	
Dark Brown	DB	

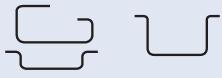
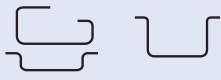
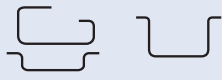
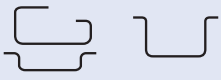

\* Add required voltage to part number as a suffix. i.e. CSFL4U(L)/24 for 24V AC/DC.

CAFL4U			CAFL4U(L)*			CAFL4U(N)			CSFL6U		
											
† Fuse not included.			† Fuse not included.			† Fuse not included.			† Fuse not included.		
9 mm			9 mm			9 mm			8 mm		
50 x 72 mm			50 x 70 mm			50 x 70 mm			60 x 43 mm		
12 mm			12 mm			12 mm			12 mm		
Polyamide 6.6			Polyamide 6.6			Polyamide 6.6			Polyamide 6.6		
2 screw clamps			2 screw clamps			2 screw clamps			2 screw clamps		
Ø1/4x1 in., Ø1/4x1 1/4 in.			Ø1/4x1 in., Ø1/4x1 1/4 in.			Ø1/4x1 in., Ø1/4x1 1/4 in.			Ø5x20, Ø5x25 mm		
 			 			 			 		
22-10 AWG	0.5-4 sq.mm	22-10 AWG	22-10 AWG	0.5-4 sq.mm	22-10 AWG	22-10 AWG	0.5-4 sq.mm	22-10 AWG	22-8 AWG	1.5-6 sq.mm	22-8 AWG
600 V	600 V	600 V	600 V	600 V	600 V	600 V	600 V	600 V	300 V	500 V	300 V
16 A	6.3 A	12 A	16 A	6.3 A	12 A	16 A	6.3 A	12 A	10 A	6.3 A	10 A
7 lb-in	0.5 Nm	7 lb-in	7 lb-in	0.5 Nm	7 lb-in	7 lb-in	0.5 Nm	7 lb-in	14 lb-in	0.8 Nm	14 lb-in
<b>Cat. No.</b>	<b>Std. Pk.</b>		<b>Cat. No.</b>	<b>Std. Pk.</b>		<b>Cat. No.</b>	<b>Std. Pk.</b>		<b>Cat. No.</b>	<b>Std. Pk.</b>	
CAFL4U	25		CAFL4U(L)*	25		CAFL4U(N)	25		CSFL6U	50	
EPCAFL4U	50		EPCAFL4U	50		EPCAFL4U	50		EPCSFL6U	50	
											
CA702	50		CA702	50		CA702	50		CA702	50	
CA802	50		CA802	50		CA802	50		CA802	50	
CA716/2	50		CA716/2	50		CA716/2	50		CA710/2	100	
CA716/3	50		CA716/3	50		CA716/3	50		CA710/3	100	
CA716/4	50		CA716/4	50		CA716/4	50		CA710/4	100	
CA716/10	25		CA716/10	25		CA716/10	25		CA710/10	25	
MT9	100		MT9	100		MT9	100		MT8	100	
									MT6	100	

\* Add required voltage to part number as a suffix. i.e. CSFL4U(L)/24 for 24V AC/DC.

## FUSE BLOCKS

DDFL4U - Double Level Fuse Terminal with fuse link on the top level has a separate feed through terminal at the lower level. This eliminates use of an additional feed through terminal.

In DDFL4U(E), specially designed built in circuit gives light indication in the event of a fuse blow out at the top level. The terminal provides separate feed through connection possibility at the lower level.

DDFL4U(LR): This is a modified version of DDFL4U(E) terminal where in two equipotential connection points are available on both ends of the terminal.

**Important:** The disconnecting device is not suitable for interrupting load. The supply must be switched off before operating the slide link/lever.

† Fuses are sold separately  
Altech, see page 34  
for details.



### COLOR BLOCKS

(other than grey standard)

When ordering please add color suffix to Cat. No.

Example: CTS2.5U-N/R

Color	Ordering Suffix
Red	R
Blue	BU
Black	BL
Orange	O
Green	G
Yellow	Y
White	W
Beige	BG
Dark Brown	DB

## DDFL4U

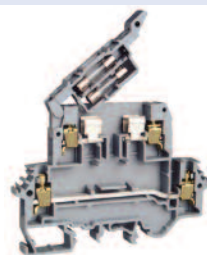

† Fuse not included.

## DDFL4U(E)\*

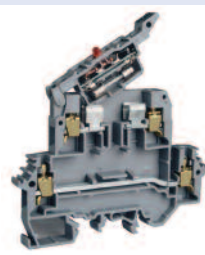

† Fuse not included.

Terminal Width	8 mm			8 mm		
Height x Length	66 x 88 mm			66 x 88 mm		
Stripping Length	9.5 mm			9.5 mm		
Insulation Material	Polyamide 6.6			Polyamide 6.6		
Type of Connection	4 screw clamps			4 screw clamps		
Fusion Voltage				24V AC/DC, 48V AC/DC, 110V AC/DC, 220V AC		
Type of Fuse Used	Ø5x20, Ø5x25 mm			Ø5x20, Ø5x25 mm		
Approvals						
Wire Range	22-10 AWG	0.5-4 sq.mm	22-10 AWG	22-10 AWG	0.5-4 sq.mm	22-10 AWG
Voltage Rating	600 V	600 V	600 V	600 V	600 V	600 V
Current Rating	Top Level Bottom Level	6.3 A 35 A	6.3 A 32 A	8 A 35 A	6.3 A 32 A	8 A 35 A
Torque	7 lb-in	0.5 Nm	7 lb-in	7 lb-in	0.5 Nm	7 lb-in
	<b>Cat. No.</b>	<b>Std. Pk.</b>		<b>Cat. No.</b>	<b>Std. Pk.</b>	
Terminal Block	DDFL4U	20		DDFL4U(E)*	20	
End Plate	EPDDL4U	25		EPDDL4U	25	
DIN Rail	<i>for ordering information refer to page 62</i>					
End Stop	<i>for ordering information refer to page 63</i>					
Internal Jumper	2 pole 3 pole 4 pole 10 pole		CA729/2 CA729/3 CA729/4 CA729/10	100 50 50 10	CA729/2 CA729/3 CA729/4 CA729/10	100 50 50 10
Insulated Internal Jumper	2 pole 3 pole 4 pole 10 pole		CA749/2 CA749/3 CA749/4 CA749/10	100 50 50 10	CA749/2 CA749/3 CA749/4 CA749/10	100 50 50 10
Current Bar	2 pole 3 pole 4 pole 10 pole		CA703/6 CA704/6 CA705/6 CA737/10	100 100 100 100	CA703/6 CA704/6 CA705/6 CA737/10	100 100 100 100
Shorting Sleeve & Screw			CA707/S/Q/3	100	CA707/S/Q/3	100
External Jumper	2 pole 3 pole 4 pole 10 pole		CA711/2 CA711/3 CA711/4 CA711/10	100 100 50 25	CA711/2 CA711/3 CA711/4 CA711/10	100 100 50 25
Marking Tags	(MT Type) (MT Type on Lever)		MT8 MT2	100 100	MT8 MT2	100 100

\*Add required voltage to part number as a suffix. i.e. DDFL4U(E)/24 for 24V AC/DC. \*\* 25A @ 500 V, 10A @ 690V, 16A @ 500V for fast blow.





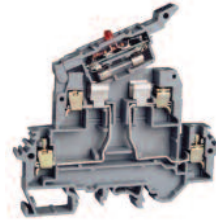
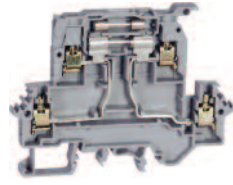



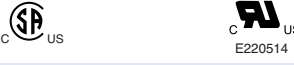
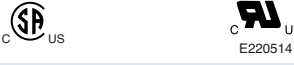

## DDFL4ULR

## DDFL4U(E)LR\*

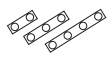

† Fuse not included.

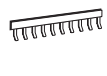
† Fuse not included.

Terminal Width	8 mm			8 mm		
Height x Length	66 x 88 mm			66 x 88 mm		
Stripping Length	9.5 mm			9.5 mm		
Insulation Material	Polyamide 6.6			Polyamide 6.6		
Type of Connection	4 screw clamps			4 screw clamps		
Fusion Voltage				24V AC/DC, 48V AC/DC, 110V AC/DC, 220V AC		
Type of Fuse Used	Ø5x20, Ø5x25 mm			Ø5x20, Ø5x25 mm		
Approvals						
Wire Range	22-10 AWG	0.5-4 sq.mm	22-10 AWG	22-10 AWG	0.5-4 sq.mm	22-10 AWG
Voltage Rating	600 V	600 V	600 V	600 V	600 V	600 V
Current Rating	6.3 A	6.3 A	6.3 A	6.3 A	6.3 A	6.3 A
	Top Level			Bottom Level		
Torque	7 lb-in	0.5 Nm	7 lb-in	7 lb-in	0.5 Nm	7 lb-in
	<b>Cat. No.</b>	<b>Std. Pk.</b>		<b>Cat. No.</b>	<b>Std. Pk.</b>	
Terminal Block	DDFL4ULR	20		DDFL4U(E)LR*	20	
End Plate	EPDDFL4U	20		EPDDFL4U	20	
DIN Rail						
	CA702	50		CA702	50	
	CA802	50		CA802	50	
End Stop						
	CA729/2	100		CA729/2	100	
	CA729/3	50		CA729/3	50	
	CA729/4	50		CA729/4	50	
	CA729/10	10		CA729/10	10	
Internal Jumper						
	CA749/2	100		CA749/2	100	
	CA749/3	50		CA749/3	50	
	CA749/4	50		CA749/4	50	
	CA749/10	10		CA749/10	10	
Insulated Internal Jumper						
	CA703/6	100		CA703/6	100	
	CA704/6	100		CA704/6	100	
	CA705/6	100		CA705/6	100	
	CA738/10	100		CA737/10	100	
Current Bar						
	CA707/S/Q/3	100		CA707/S/Q/3	100	
Shorting Sleeve & Screw						
	CA711/2	100		CA711/2	100	
	CA711/3	100		CA711/3	100	
	CA711/4	50		CA711/4	50	
	CA711/10	25		CA711/10	25	
External Jumper						
	MT8	100		MT8	100	
	MT2	100		MT2	100	
Marking Tags						
	(MT Type)			(MT Type)		
	(MT Type on Lever)			(MT Type on Lever)		

**\*Add required voltage to part number as a suffix. i.e. DDFL4U(E)LR/24 for 24V AC/DC. 1 Left or right side connection.**

## FUSE HOLDERS

The main characteristics of fuse disconnectors are:









- Compliance with IEC 60947-1, IEC 60947-3
- UL508 recognized
- Plastic parts are made of material resistant to high temperatures
- All contact surfaces are silver plated
- Mounting on standard DIN 35 mm rail (DIN EN60715).
- Available up to 4 pole
- For all sizes a version with electronic indicator is available. There are two technical types of indicator:

**L (LED)** with built in LED diode which blinks after the fuse-link operates. The internal circuit resistance is 2M, thus the total dissipation is minimal. The indicator is capable of operating in conditions of open circuit with minimum capacitance between connection cables.

Operating voltage range spans from 50V to 690V AC and DC.

**I (NEON)** with neon lamp, which is constantly lit after the fuse-link operates. The internal circuit resistance is 570k, thus it is necessary that the circuit be closed in order for the indicator to function. The operational voltage range is 100 V to 750 V AC.

**\* Fuses are sold separately Altech, see page 34 for details.**

	1 POLE			2 POLE			3 POLE		
									
Terminal Width (B)	17.5 mm			35 mm			52.5 mm		
Height x Length	77 x 63.5 mm			77 x 63.5 mm			77 x 63.5 mm		
Stripping Length	11 mm			11 mm			11 mm		
Insulation Material	Aculon®			Aculon®			Aculon®		
Type of Connection	2 screw clamps			2 screw clamps			2 screw clamps		
Fusion Voltage									
Type of Fuse Used	Ø10 x 38 mm			Ø10 x 38 mm			Ø10 x 38 mm		
Approvals									
Wire Range	24-4 AWG	1.5-25sq.mm	24-4 AWG	24-4 AWG	1.5-25sq.mm	24-4 AWG	24-4 AWG	1.5-25sq.mm	24-4 AWG
Voltage Rating	690 V	400 V**	690 V	690 V	400 V**	690 V	690 V	400 V**	690 V
Current Rating	32A	32A**	32A	32A	32A**	32A	32A	32A**	32A
Torque	31 lb-in	2-2.5 Nm	31 lb-in	31 lb-in	2-2.5 Nm	31 lb-in	31 lb-in	2-2.5 Nm	31 lb-in
	<b>Cat. No.</b>	<b>Std. Pk.</b>		<b>Cat. No.</b>	<b>Std. Pk.</b>		<b>Cat. No.</b>	<b>Std. Pk.</b>	
Terminal Block Indicator:									
None	CB1038-1	1		CB1038-2	1		CB1038-3	1	
LED	CB1038-1/L	1		CB1038-2/L	1		CB1038-3/L	1	
Neon	CB1038-1/I	1		CB1038-2/I	1		CB1038-3/I	1	
End Plate									
DIN Rail <i>for ordering information refer to page 62</i>									
End Stop <i>for ordering information refer to page 63</i>	CA702	50		CA702	50		CA702	50	
	CA802	50		CA802	50		CA802	50	

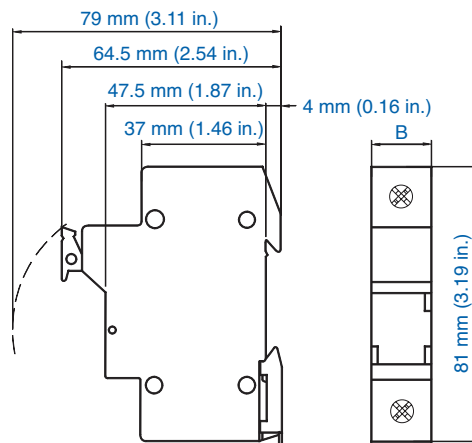

Dimension for B:	
1 Pole	17.5mm
1 Pole + Neutral	35mm
2 Pole	35mm
3 Pole	52.5mm
3 Pole + Neutral	70mm

## FUSES

Cylinder Fuses are typically used in industrial applications to protect electrical devices such as motors, drives, etc.

They are available in four sizes with a current range from 1 to 125 Amps. Cylinder Fuses have metal caps at both ends, and a porcelain fuse body.

Please refer to pg 34 for ordering information for Cylinder Fuse Bases.

### OPERATING CLASSES

#### gL/gG - Line Protection

Slow, typically used for distribution circuits or resistive loads.

Typical Markings: gL/gG

#### aM - Motor Protection

Fast acting short circuit protection, but slow acting overload protection.

Typical Marking: aM

#### aR - Semiconductor Protection

Partial range, short circuit protection for devices such as diodes, SCRs. etc.

Typical Markings: Ultra Rapid™, Sitor™, Silcu™, Protister™, Recticur™, Ultra Quick™, aR 

#### gR - Semiconductor Protection

Full range, short circuit protection for devices such as diodes, SCRs. etc.

Typical Markings: Ultra Rapid™, Sitor™, Silcu™, Protister™, Recticur™, Ultra Quick™, gR 

#### Note:

Other fuse sizes and fuse holders are available. Please refer to the Altech European Fuse catalog for more information.

#### gL/gG - Line Protection

Standard: IEC 20269-4-1 and IEC60269-1  
Rated Voltage: 500V



10x38

Rated Current/ Rated Voltate	Cat. No.	Std. Pk.
0.5A	2620017	10
1A	2620000	10
2A	2620001	10
4A	2620003	10
6A	2620005	10
8A	2620006	10
10A	2620007	10
12A	2620008	10
16A	2620009	10
20A	2620011	10
25A	2620013	10
32A*	2620015	10

\*400V

#### aM - Motor Protection

Standard: IEC 20269-4-1 and IEC60269-1  
Rated Voltage: 500V



10x38

Rated Current/ Rated Voltate	Cat. No.	Std. Pk.
0.5A	2621017	10
1A	2621000	10
2A	2621001	10
4A	2621003	10
6A	2621005	10
8A	2621006	10
10A	2621007	10
12A	2621008	10
16A	2621009	10
20A	2621011	10
25A	2621013	10
32A*	2621015	10

\*400V

#### aR - Semiconductor Protection

Standard: IEC 60269-4-1  
Breaking Capacity: ~200 kA  
Rated Voltage: ~600V\*\*



10x38

In (A)	Cat. No.	Operating I <sup>2</sup> -value (A's)	Power Dissipation (W)	Std. Pk.
6	2625005	30	1.5	10
8	2625006	50	2	10
10	2625007	70	2.5	10
12	2625008	120	3	10
16	2625009	150	3.5	10
20	2625011	260	4.8	10
25	2625013	290	6	10
32	2625015	600	7.5	10

\*\* 6-25A (700V DC/ breaking capacity --- 50kA)  
32A (400V DC/ breaking capacity --- 50kA)

#### gR - Semiconductor Protection

Standard: IEC 60269-4-1  
Breaking Capacity: ~200 kA  
Rated Voltage: ~690V

 Certified for 700V



10x38

In (A)	Cat. No.	Operating I <sup>2</sup> -value (A's)	Power Dissipation (W)	Std. Pk.
1	2645126	1.6	1	10
2	2645127	8	1.8	10
4	2645128	8	1.1	10
6	2645129	25	1.6	10
8	2645130	39	1.8	10
10	2645131	66	2.1	10
12	2645132	87	3.1	10
16	2645133	166	4.4	10
20	2645134	280	5.8	10
25	2645135	580	6.8	10
30	2645136	1.010	8.2	10

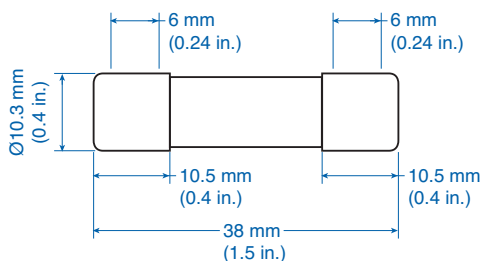



## MINIATURE FUSES

Miniature Fuses are typically used to protect electronic devices, laboratory and measurement instruments, stereos, TV's, VCR's etc. They are available in four sizes with a current range of 20mA to 20 Amps.

Miniature Fuses are manufactured according to VDE 0820 part 1, VDE 0820 part 2, IEC publication 127, CEE publication 4 and actual DIN standards.

The 5x20, 5x25 fuses can be used in the CSFL4U series terminal blocks. The 6.3x32 fuse can be used in the CAFL4U series terminal blocks.

Operating Class:

**Slow**, Typical Marking: "T"

**Medium**, Typical Marking: "M"

**Fast**, Typical Marking: "F"

5 X 20

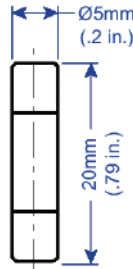

5 X 25

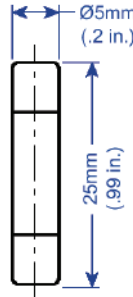

6.3 X 32 (1/4" X 1-1/4")

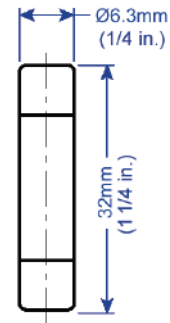

Current	Voltage 250V AC/DC DIN 41662 IEC-127-2/III			Voltage 250V AC/DC DIN 41571-2		Voltage 250V AC/DC DIN 41571-2	
	Slow	Medium	Fast	Medium	Slow	Fast	
20mA		0.02M5x20M					
32mA		0.032M5x20M					
40mA							
50mA	0.05M5x20T <sup>4</sup>	0.05M5x20M	0.05M5x20F <sup>4</sup>	0.05M5x25M	0.05M6.3x32T <sup>4</sup>	0.05M6.3x32F	
63mA		0.063M5x20M		0.063M5x25M	0.063M6.3x32T <sup>4</sup>	0.063M6.3x32F	
80mA	0.08M5x20T <sup>4</sup>	0.08M5x20M		0.08M5x25M	0.08M6.3x32T <sup>4</sup>	0.08M6.3x32F	
100mA	0.1M5x20T <sup>4</sup>	0.1M5x20M	0.1M5x20F <sup>4</sup>	0.1M5x25M	0.1M6.3x32T <sup>4</sup>	0.1M6.3x32F	
125mA	0.125M5x20T <sup>4</sup>	0.125M5x20M	0.125M5x20F <sup>4</sup>	0.125M5x25M	0.125M6.3x32T <sup>4</sup>	0.125M6.3x32F	
160mA	0.16M5x20T <sup>4</sup>	0.16M5x20M	0.16M5x20F <sup>4</sup>	0.16M5x25M	0.16M6.3x32T <sup>4</sup>	0.16M6.3x32F	
200mA	0.2M5x20T <sup>4</sup>	0.2M5x20M	0.2M5x20F <sup>4</sup>	0.2M5x25M	0.2M6.3x32T <sup>4</sup>	0.2M6.3x32F	
250mA	0.25M5x20T <sup>4</sup>	0.25M5x20M	0.25M5x20F <sup>4</sup>	0.25M5x25M	0.25M6.3x32T <sup>4</sup>	0.25M6.3x32F	
315mA	0.315M5x20T <sup>4</sup>	0.315M5x20M	0.315M5x20F <sup>4</sup>	0.315M5x25M	0.315M6.3x32T <sup>4</sup>	0.315M6.3x32F	
400mA	0.4M5x20T <sup>4</sup>	0.4M5x20M	0.4M5x20F <sup>4</sup>	0.4M5x25M	0.4M6.3x32T <sup>4</sup>	0.4M6.3x32F	
500mA	0.5M5x20T <sup>4</sup>	0.5M5x20M	0.5M5x20F <sup>4</sup>	0.5M5x25M	0.5M6.3x32T <sup>4</sup>	0.5M6.3x32F	
630mA	0.63M5x20T <sup>4</sup>	0.63M5x20M	0.63M5x20F <sup>4</sup>	0.63M5x25M	0.63M6.3x32T <sup>4</sup>	0.63M6.3x32F	
700mA	0.7M5x20T <sup>4</sup>	0.7M5x20M	0.7M5x20F <sup>4</sup>	0.8M5x25M	0.7M6.3x32T <sup>4</sup>	0.7M6.3x32F	
800mA	0.8M5x20T <sup>4</sup>	0.8M5x20M	0.8M5x20F <sup>4</sup>		0.8M6.3x32T <sup>4</sup>	0.8M6.3x32F	
1.0A	1.0M5x20T <sup>4</sup>	1.0M5x20M	1.0M5x20F <sup>4</sup>	1.0M5x25M	1.0M6.3x32T <sup>4</sup>	1.0M6.3x32F <sup>4</sup>	
1.25A	1.25M5x20T <sup>4</sup>	1.25M5x20M	1.25M5x20F <sup>4</sup>	1.25M5x25M	1.25M6.3x32T <sup>4</sup>	1.25M6.3x32F <sup>4</sup>	
1.4A	1.4M5x20T <sup>4</sup>	1.4M5x20M		1.6M5x25M			
1.6A	1.6M5x20T <sup>4</sup>	1.6M5x20M	1.6M5x20F <sup>4</sup>		1.6M6.3x32T <sup>4</sup>	1.6M6.3x32F <sup>4</sup>	
2.0A	2.0M5x20T <sup>4</sup>	2.0M5x20M	2.0M5x20F <sup>4</sup>	2.0M5x25M	2.0M6.3x32T <sup>4</sup>	2.0M6.3x32F <sup>4</sup>	
2.5A	2.5M5x20T <sup>4</sup>	2.5M5x20M	2.5M5x20F <sup>4</sup>	2.5M5x25M	2.5M6.3x32T <sup>4</sup>	2.5M6.3x32F <sup>2,4</sup>	
3.15A	3.15M5x20T <sup>4</sup>	3.15M5x20M	3.15M5x20F <sup>4</sup>	3.15M5x25M	3.15M6.3x32T <sup>4</sup>	3.15M6.3x32F <sup>2,4</sup>	
4.0A	4.0M5x20T <sup>4</sup>	4.0M5x20M	4.0M5x20F <sup>4</sup>	4.0M5x25M	4.0M6.3x32T <sup>4</sup>	4.0M6.3x32F <sup>2,4</sup>	
5.0A	5.0M5x20T <sup>4</sup>	5.0M5x20M	5.0M5x20F <sup>4</sup>	5.0M5x25M	5.0M6.3x32T <sup>4</sup>	5.0M6.3x32F <sup>3,4</sup>	
6.3A	6.3M5x20T <sup>4</sup>	6.3M5x20M	6.3M5x20F <sup>4</sup>	6.3M5x25M	6.3M6.3x32T <sup>4</sup>	6.3M6.3x32F <sup>3,4</sup>	
7.0A					7.0M6.3x32T <sup>4</sup>	7.0M6.3x32F <sup>3</sup>	
8.0A	8.0M5x20T <sup>1</sup>	8.0M5x20M	8.0M5x20F <sup>1</sup>		8.0M6.3x32T <sup>4</sup>	8.0M6.3x32F <sup>3</sup>	
10.0A	10.0M5x20T <sup>1</sup>	10.0M5x20M	10.0M5x20F <sup>1</sup>	8.0M5x25M <sup>1</sup>	10.0M6.3x32T <sup>4</sup>	10.0M6.3x32F <sup>3</sup>	
12.5A	12.5M5x20T <sup>1</sup>	12.5M5x20M <sup>1</sup>	12.5M5x20F <sup>1</sup>	10.0M5x25M <sup>1</sup>	12.5M6.3x32T <sup>4</sup>	12.5M6.3x32F <sup>3</sup>	
16.0A	16.0M5x20T <sup>1</sup>	16.0M5x20M <sup>1</sup>	16.0M5x20F <sup>1</sup>	16.0M5x25M <sup>1</sup>	16.0M6.3x32T <sup>4</sup>	16.0M6.3x32F <sup>3</sup>	
20.0A	20.0M5x20T <sup>1</sup>	20.0M5x20M <sup>1</sup>	20.0M5x20F <sup>1</sup>		20.0M6.3x32T <sup>4</sup>	20.0M6.3x32F <sup>3</sup>	
	Std. Pk. 10			Std. Pk. 10		Std. Pk. 10	

<sup>1</sup> Not standard rating.  
<sup>2</sup> Rated Voltage 150V.  
<sup>3</sup> Rated Voltage 60V.  
<sup>4</sup> UL recognized version available upon request.

## THERMOCOUPLE TERMINAL BLOCK

Altech thermocouple terminal blocks are designed for use in temperature measuring circuits.

The current carrying part of the terminal blocks have the same material (according to DIN437134 and DIN43714) which is used for compensating cables in the temperature measurement circuit (up to 200°C). Thus fulfilling the norms stated in DIN EN60584.

The terminal block is marked for the respective type of thermocouple which enables easy identification for wiring.

- CTT2.5UK 'K' type -  
Chromel (NiCr)  
Alumel (NiAl)
- CTT2.5UJ 'J' type -  
Iron (Fe)  
Constantan (CuNi)
- CTT2.5UT 'T' type -  
Copper (Cu)  
Constantan (CuNi)
- CTT2.5UE 'E' type -  
Chromel (NiCr)  
Constantan (CuNi)



### COLOR BLOCKS

(other than grey standard)

When ordering please add color suffix to Cat. No.

Example: CTS2.5U-N/R

Color	Ordering Suffix	
Red	R	
Blue	BU	
Black	BL	
Orange	O	
Green	G	
Yellow	Y	
White	W	
Beige	BG	
Dark Brown	DB	

## CTT2.5UK/J/T/E

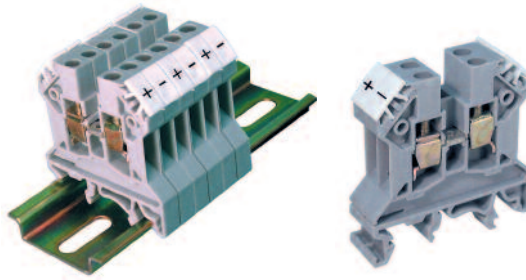

Terminal Width	10 mm
Height x Length	45 x 43 mm
Stripping Length	9 mm
Insulation Material	Polyamide 6.6
Current Carrying Material	Chromel/Alumel (NiCr/NiAl)
Type of Connection	4 screw clamps
Ratings:	
Wire Range	22-12 AWG
Voltage Rating	300 V
Current Rating	10 A
Torque	7 lb-in

	Cat. No.	Std. Pk.
Terminal Block	CTT2.5UK CTT2.5UJ CTT2.5UT CTT2.5UE	50 50 50 50
End Plate	EP2.5/4UN	50
Isolation Plate	PP2.5/4UN	50
DIN Rail for ordering information refer to page 63		
End Clamp	CA802 CA702	100 100

## Stud Type

### Terminal Blocks

Altech DIN rail mounting Stud Type Terminal Blocks are preferred for the connections that are subjected to very severe vibrations.

The wire is crimped to a ring / fork type lug and is screwed on to the flat current bar in terminal. The range includes terminal blocks for wires of size 22-4 AWG.

Jumpering can be achieved with the aid of external jumpers. The jumpers are insulated to make them shock proof. The terminal blocks have marker holding recess to accommodate MT type marking tags.

It is recommended to use protective covers in transparent plastic because assemblies of these terminals blocks are not fully covered.

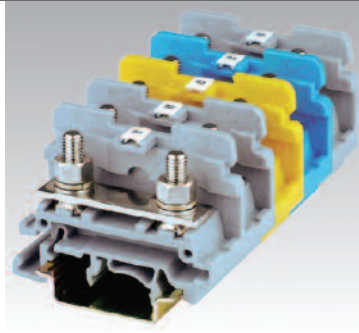

CSTSN4U

CSTSN5U

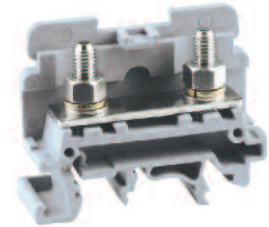
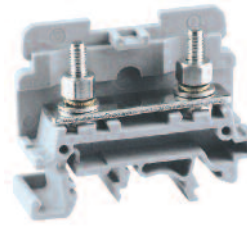

Terminal Width	17 mm			17 mm		
Height x Length	44.5 x 50 mm			44.5 x 50 mm		
Stripping Length	12 mm			12 mm		
Insulation Material	Polyamide 6.6			Polyamide 6.6		
Type of Connection	2 screw connection for M4 ring/fork lugs			2 screw connection for M5 ring/fork lugs		
Approvals						
Wire Range	22-6 AWG	1.5-10 sq.mm	22-6 AWG	22-4 AWG	1.5-16 sq.mm	22-4 AWG
Voltage Rating	600 V	800 V	600 V	600 V	800 V	600 V
Current Rating	65 A	57 A	65 A	80 A	76 A	80 A
Torque	14 lb-in	1.2 Nm	14 lb-in	17.5 lb-in	2.0 Nm	17.5 lb-in

	Cat. No.	Std. Pk.	Cat. No.	Std. Pk.	
Terminal Block	CSTSN4U	100	CSTSN5U	100	
End Plate	EPCSTSN5U	50	EPCSTSN5U	50	
DIN Rail for ordering information refer to page 62					
End Stop for ordering information refer to page 63	CA702 CA802	50 50	CA702 CA802	50 50	
Protective Cover for covering	2 Terminal 3 Terminal	CSTSPC1 CSTSPC1-1	100 100	CSTSPC1 CSTSPC1-1	100 100
Protective Cover in Length	100 mm 200 mm 300 mm	CSTSPC1-2 CSTSPC1-3 CSTSPC1-4	10 10 10	CSTSPC1-2 CSTSPC1-3 CSTSPC1-4	10 10 10
Insulated Removable Jumpers	2 way 3 way 4 way	CA514/1-2 CA514/1-3 CA514/1-4	100 50 50	CA514/1-2 CA514/1-3 CA514/1-4	100 50 50
Insulated Permanent Jumpers	2 way 3 way 4 way	CA514/3-2 CA514/3-3 CA514/3-4	100 50 50	CA514/3-2 CA514/3-3 CA514/3-4	100 50 50
Marking Tags (MTType)	MT2	100	MT2	100	



### COLOR BLOCKS

(other than grey standard)

When ordering please add color suffix to Cat. No.

Example: CTS2.5U-N/R

Color	Ordering Suffix
Red	R
Blue	BU
Black	BL
Orange	O
Green	G
Yellow	Y
White	W
Beige	BG
Dark Brown	DB

<sup>1</sup> Approval pending.



Terminal Width	17 mm			17 mm		
Height x Length	44.5 x 50 mm			44.5 x 50 mm		
Stripping Length	12 mm			12 mm		
Insulation Material	Polyamide 6.6			Polyamide 6.6		
Type of Connection	2 screw connection for M4 ring/fork lugs			2 screw connection for M5 ring/fork lugs		
Approvals						
Wire Range	22-6 AWG	1.5-10 sq.mm	22-6 AWG	22-4 AWG	1.5-16 sq.mm	22-4 AWG
Voltage Rating	600 V	800 V	600 V	600 V	800 V	600 V
Current Rating	65 A	57 A	65 A	80 A	76 A	80 A
Torque	14 lb-in	1.2 Nm	14 lb-in	17.5 lb-in	2.0 Nm	17.5 lb-in

		Cat. No.	Std. Pk.	Cat. No.	Std. Pk.
Terminal Block		CSTSB4U	100	CSTSB5U	100
End Plate		EPCSTN5U	50	EPCSTN5U	50
DIN Rail	for ordering information refer to page 62				
End Stop	for ordering information refer to page 63	CA702 CA802	50 50	CA702 CA802	50 50
Protective Cover for covering	2 Terminal 3 Terminal	CSTSPC1 CSTSPC1-1	100 100	CSTSPC1 CSTSPC1-1	100 100
Protective Cover in Length	100 mm 200 mm 300 mm	CSTSPC1-2 CSTSPC1-3 CSTSPC1-4	10 10 10	CSTSPC1-2 CSTSPC1-3 CSTSPC1-4	10 10 10
Insulated Removable Jumpers	2 way 3 way 4 way	CA514/1-2 CA514/1-3 CA514/1-4	100 50 50	CA514/1-2 CA514/1-3 CA514/1-4	100 50 50
Insulated Permanent Jumpers	2 way 3 way 4 way	CA514/3-2 CA514/3-3 CA514/3-4	100 50 50	CA514/3-2 CA514/3-3 CA514/3-4	100 50 50
Marking Tags (MTType)		MT2	100	MT2	100

<sup>1</sup> Approval pending.

## INDICATOR/ DIODE CIRCUITS

### 35 or 32mm DIN Rail

Altech offers different types of terminals incorporating electronic components for signal converting, circuit protection and status indication. Based on customer requirements, specially assembled terminals are offered.

CDL4U(O) - Double level terminal with open lower current bar to accommodate electronic components like diodes, resistors, LEDs, etc.

#### Diode Specifications

Diode	1N 4007
Diode Reverse Voltage	1000 V
Diode Current	1 A

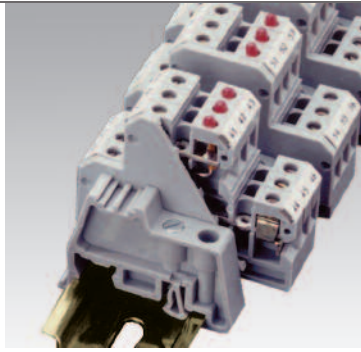

#### CDL4U(E)D1/D2

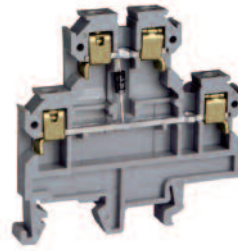

With arc suppression circuit for contactors and solenoid valves - DC

#### CDL4U(E)D3

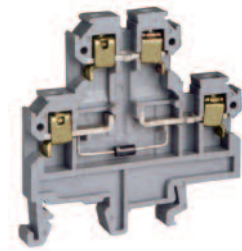

Diode circuit for reverse polarity protection

Terminal Width	6 mm			6 mm		
Height x Length	54 x 55.5 mm			54 x 55.5 mm		
Terminal Voltage	300 V~			300 V~		
Stripping Length	9 mm			9 mm		
Approvals						
Wire Range	22-10 AWG	0.5-4 sq.mm	22-10 AWG	22-10 AWG	0.5-4 sq.mm	22-10 AWG
Voltage Rating	600 V	400 V	600 V	600 V	400 V	600 V
Current Rating	25 A	32 A	35 A	25 A	32 A	35 A
Torque	7 lb-in	0.5 Nm	7 lb-in	7 lb-in	0.5 Nm	7 lb-in

	Cat. No.	Std. Pk.	Cat. No.	Std. Pk.
Terminal Block	CDL4U(E)D1 CDL4U(E)D2	100 100	CDL4U(E)D3	100
End Plate	EPCDL4U	50	EPCDL4U	50
DIN Rail for ordering information refer to page 62				
End Stop for ordering information refer to page 63	CA702 CA802	50 50	CA702 CA802	50 50
Internal Jumper	2 pole 3 pole 4 pole 10 pole	CA727/2 10 CA727/3 10 CA727/4 10 CA727/10 10	2 pole 3 pole 4 pole 10 pole	CA727/2 10 CA727/3 10 CA727/4 10 CA727/10 10
Current Bars	2 pole 3 pole 4 pole 10 pole 10 pole (breakable) 100 pole	CA703/1 100 CA704/1 100 CA705/1 100 CA732/10 100 CA732/10-A 100 CA732/100 10	2 pole 3 pole 4 pole 10 pole 10 pole (breakable) 100 pole	CA703/1 100 CA704/1 100 CA705/1 100 CA732/10 100 CA732/10-A 100 CA732/100 10
Shorting Sleeve & Screw	CA607/S/Q	100	CA607/S/Q	100
Marking Tags (MT Type)	MT2	100	MT2	100



### COLOR BLOCKS

(other than grey standard)

When ordering please add color suffix to Cat. No.

Example: CTS2.5U-N/R

Color	Ordering Suffix	
Red	R	
Blue	BU	
Black	BL	
Orange	O	
Green	G	
Yellow	Y	
White	W	
Beige	BG	
Dark Brown	DB	

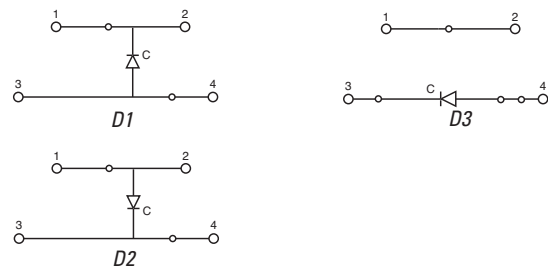

## CDL4U(E)DD1/DD2

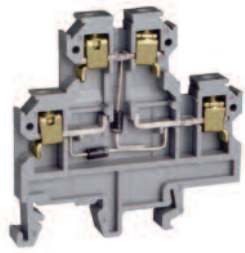

Diode circuit for lamp testing

## CDL4U(E)DD3/DD4

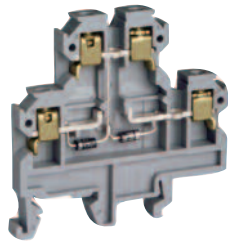

Diode circuit for lamp testing

## CDL4U(E)D4

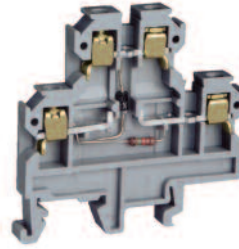

Diode circuit for lamp testing with LED series resistance

## CDL4U(E)DD5

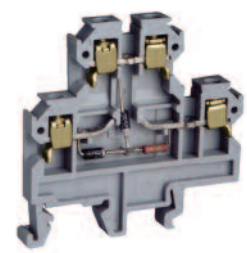

Diode circuit for lamp testing with LED series resistance

6 mm			6 mm			6 mm			6 mm		
54 x 55.5 mm			54 x 55.5 mm			54 x 55.5 mm			54 x 55.5 mm		
300 V~			300 V~			24 V~			24 V~		
9 mm			9 mm			9 mm			9 mm		
22-10 AWG	0.5-4 sq.mm	22-10 AWG	22-10 AWG	0.5-4 sq.mm	22-10 AWG	22-10 AWG	0.5-4 sq.mm	22-10 AWG	22-10 AWG	0.5-4 sq.mm	22-10 AWG
600 V	400 V	600 V	600 V	400 V	600 V	600 V	400 V	600 V	600 V	400 V	600 V
25 A	32 A	35 A	25 A	32 A	35 A	25 A	32 A	35 A	25 A	32 A	35 A
7 lb-in	0.5 Nm	7 lb-in	7 lb-in	0.5 Nm	7 lb-in	7 lb-in	0.5 Nm	7 lb-in	7 lb-in	0.5 Nm	7 lb-in

Cat. No.	Std. Pk.	Cat. No.	Std. Pk.	Cat. No.	Std. Pk.	Cat. No.	Std. Pk.
CDL4U(E)DD1	100	CDL4U(E)DD3	100	CDL4U(E)D4	100	CDL4U(E)DD5	100
CDL4U(E)DD2	100	CDL4U(E)DD4	100				
EPCDL4U	50	EPCDL4U	50	EPCDL4U	50	EPCDL4U	50
CA702	50	CA702	50	CA702	50	CA702	50
CA802	50	CA802	50	CA802	50	CA802	50
CA727/2	10	CA727/2	10	CA727/2	10	CA727/2	10
CA727/3	10	CA727/3	10	CA727/3	10	CA727/3	10
CA727/4	10	CA727/4	10	CA727/4	10	CA727/4	10
CA727/10	10	CA727/10	10	CA727/10	10	CA727/10	10
CA703/1	100	CA703/1	100	CA703/1	100	CA703/1	100
CA704/1	100	CA704/1	100	CA704/1	100	CA704/1	100
CA705/1	100	CA705/1	100	CA705/1	100	CA705/1	100
CA732/10	100	CA732/10	100	CA732/10	100	CA732/10	100
CA732/10-A	100	CA732/10-A	100	CA732/10-A	100	CA732/10-A	100
CA732/100	10	CA732/100	10	CA732/100	10	CA732/100	10
CA607/S/Q	100	CA607/S/Q	100	CA607/S/Q	100	CA607/S/Q	100
MT2	100	MT2	100	MT2	100	MT2	100

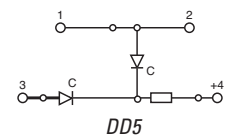
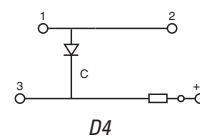
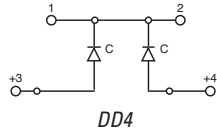
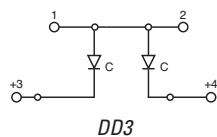
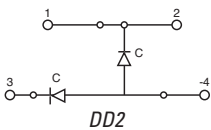
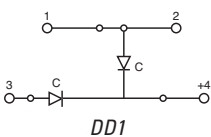

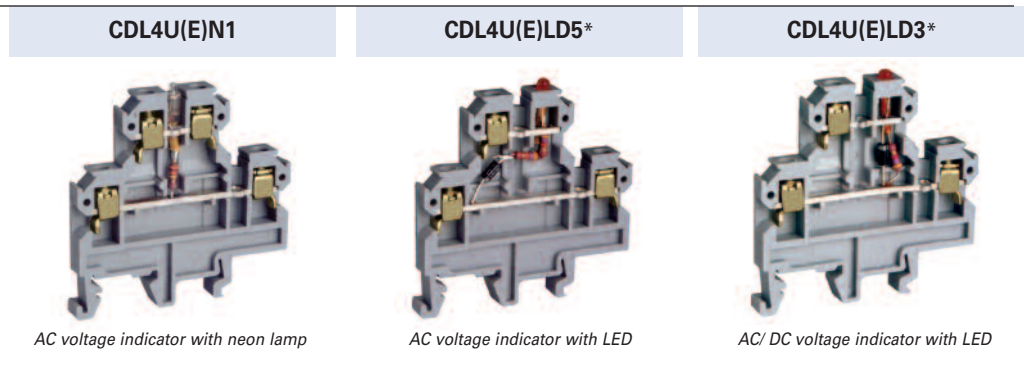
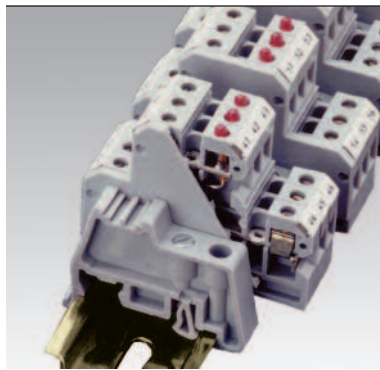





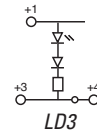
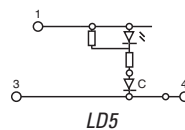
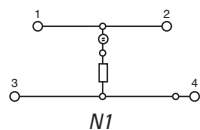



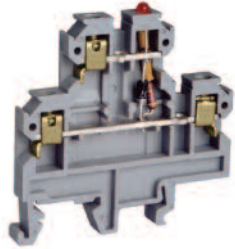
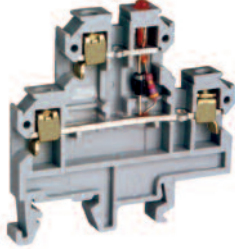
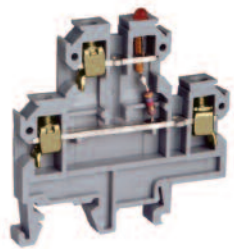
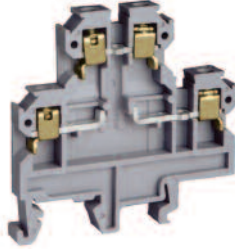







Terminal Width	6 mm			6 mm			6 mm		
Height x Length	54 x 55.5 mm			54 x 55.5 mm			54 x 55.5 mm		
Terminal Voltage	100 V~ to 220 V			24 V~, 48 V~, 120V~, 220V~			12 V~, 24 V~		
Stripping Length	9 mm			9 mm			9 mm		
Approvals									
Wire Range	22-10 AWG	0.5-4 sq.mm	22-10 AWG	22-10 AWG	0.5-4 sq.mm	22-10 AWG	22-10 AWG	0.5-4 sq.mm	22-10 AWG
Voltage Rating	600 V	400 V	600 V	600 V	400 V	600 V	600 V	400 V	600 V
Current Rating	25 A	32 A	35 A	25 A	32 A	35 A	25 A	32 A	35 A
Torque	7 lb-in	0.5 Nm	7 lb-in	7 lb-in	0.5 Nm	7 lb-in	7 lb-in	0.5 Nm	7 lb-in

		Cat. No.	Std. Pk.		Cat. No.	Std. Pk.		Cat. No.	Std. Pk.
Terminal Block		CDL4U(E)N1	50		CDL4U(E)LD5*	50		CDL4U(E)LD3*	50
End Plate		EPCDL4U	50		EPCDL4U	50		EPCDL4U	50
DIN Rail for ordering information refer to page 62									
End Stop for ordering information refer to page 63		CA702	50		CA702	50		CA702	50
		CA802	50		CA802	50		CA802	50
Internal Jumper		2 pole	CA727/2	10	2 pole	CA727/2	10	2 pole	CA727/2
		3 pole	CA727/3	10	3 pole	CA727/3	10	3 pole	CA727/3
		4 pole	CA727/4	10	4 pole	CA727/4	10	4 pole	CA727/4
		10 pole	CA727/10	10	10 pole	CA727/10	10	10 pole	CA727/10
Current Bars		2 pole	CA703/1	100	2 pole	CA703/1	100	2 pole	CA703/1
		3 pole	CA704/1	100	3 pole	CA704/1	100	3 pole	CA704/1
		4 pole	CA705/1	100	4 pole	CA705/1	100	4 pole	CA705/1
		10 pole	CA732/10	100	10 pole	CA732/10	100	10 pole	CA732/10
		10 pole (breakable)	CA732/10-A	100	10 pole (breakable)	CA732/10-A	100	10 pole (breakable)	CA732/10-A
		100 pole	CA732/100	10	100 pole	CA732/100	10	100 pole	CA732/100
Shorting Sleeve & Screw		CA607/S/Q	100		CA607/S/Q	100		CA607/S/Q	100
Marking Tags (MT Type)		MT2	100		MT2	100		MT2	100



\* Add required voltage to part number as a suffix  
i.e. CDL4U(E)LD5/110 is for 110V.

CDL4U(E)LD4*	CDL4U(E)LD1/LD2	CDL4U(E)L1/L2*	CDL4U(O)
			
AC/DC voltage indicator with LED	DC voltage indicator with LED	DC voltage indicator with LED	Electronic Component Carrier
6 mm	6 mm	6 mm	6 mm
54 x 55.5 mm	54 x 55.5 mm	54 x 55.5 mm	54 x 55.5 mm
24 V~	24 V-	6 V-, 24 V-, 60 V-	-
9 mm	9 mm	9 mm	9 mm
  	  	  	  
22-10 AWG 0.5-4 sq.mm 22-10 AWG	22-10 AWG 0.5-4 sq.mm 22-10 AWG	22-10 AWG 0.5-4 sq.mm 22-10 AWG	22-10 AWG 0.5-4 sq.mm 22-10 AWG
600 V 400 V 600 V	600 V 400 V 600 V	600 V 400 V 600 V	600 V 400 V 600 V
25 A 32 A 35 A	25 A 32 A 35 A	25 A 32 A 35 A	25 A 32 A 35 A
7 lb-in 0.5 Nm 7 lb-in	7 lb-in 0.5 Nm 7 lb-in	7 lb-in 0.5 Nm 7 lb-in	7 lb-in 0.5 Nm 7 lb-in

Cat. No.	Std. Pk.	Cat. No.	Std. Pk.	Cat. No.	Std. Pk.	Cat. No.	Std. Pk.
CDL4U(E)LD4*	50	CDL4U(E)LD1 CDL4U(E)LD2	50 50	CDL4U(E)L1* CDL4U(E)L2*	50 50	CDL4U(O)	100
EPCDL4U	50	EPCDL4U	50	EPCDL4U	50	EPCDL4U	50
							
CA702 CA802	50 50	CA702 CA802	50 50	CA702 CA802	50 50	CA702 CA802	50 50
CA727/2 CA727/3 CA727/4 CA727/10	10 10 10 10	CA727/2 CA727/3 CA727/4 CA727/10	10 10 10 10	CA727/2 CA727/3 CA727/4 CA727/10	10 10 10 10	CA727/2 CA727/3 CA727/4 CA727/10	10 10 10 10
CA703/1 CA704/1 CA705/1 CA732/10 CA732/10-A CA732/100	100 100 100 100 100 10	CA703/1 CA704/1 CA705/1 CA732/10 CA732/10-A CA732/100	100 100 100 100 100 10	CA703/1 CA704/1 CA705/1 CA732/10 CA732/10-A CA732/100	100 100 100 100 100 10	CA703/1 CA704/1 CA705/1 CA732/10 CA732/10-A CA732/100	100 100 100 100 100 10
CA607/S/Q	100	CA607/S/Q	100	CA607/S/Q	100	CA607/S/Q	100
MT2	100	MT2	100	MT2	100	MT2	100

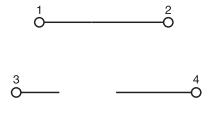
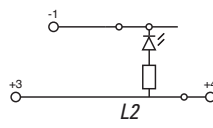
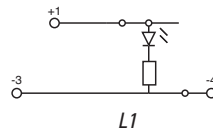
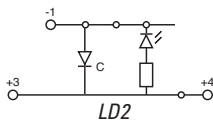
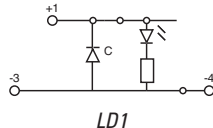
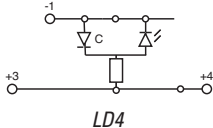

\* Add required voltage to part number as a suffix  
i.e. CDL4U(E)LD5/110 is for 110V.





## SURGE SUPPRESSOR TERMINAL BLOCKS

In applications where circuit protection against transient overvoltage is required, Altech Surge Suppressor Terminal Blocks with built-in electronic components are recommended.

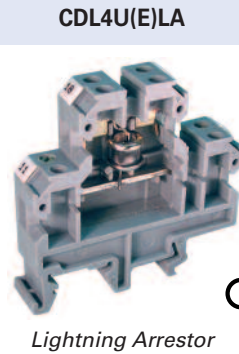
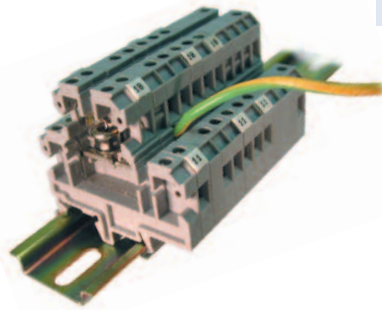
These terminals are designed to protect a single line against a longitudinal (line / earth) surge, thereby protecting distribution and inputs.

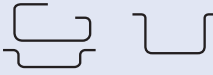
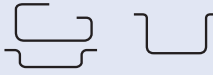

Terminal Width	12 mm	18 mm
Height x Length	54 x 55.5 mm	54 x 55.5 mm
Stripping Length	9 mm	9 mm
Insulation Material	Polyamide 6.6	Polyamide 6.6
Type of Connection	4 screw clamps	4 screw clamps
Ratings		
Wire Range	22-10 AWG	22-10 AWG
Voltage Rating	75, 90, 240, 600, 1000 V DC	90, 250, 350, 450 V DC
Nominal Discharge Current	20 KA (8/20 μs)	10 KA (8/20 μs)
Peak Current	-	-
Response Time	100 ns	100 ns
Nominal Current	10A	5A
Capacitance	<1.5 pf	<1.0 pf
Application	For coarse line protection of measuring, distributing or data communication interfaces.	For simultaneous protection of lines against transversal (line/line) and longitudinal (line/earth) surge.

	Cat. No.	Std. Pk.	Cat. No.	Std. Pk.
Terminal Block	CDL4U(E)LA*	20	CDL4U(E)3LA*	20
End Plate 	EPCDL4U	50	EPCDL4U	50
DIN Rail <i>for ordering information refer to page 62</i>				
End Stop <i>for ordering information refer to page 63</i> 	CA702 CA802	50 50	CA702 CA802	50 50
Marking Tags (MT Type) 	MT2	100	MT2	100



### COLOR BLOCKS

(other than grey standard)

When ordering please add color suffix to Cat. No.

Example: CTS2.5U-N/R

Color	Ordering Suffix
Red	R 
Blue	BU 
Black	BL 
Orange	O 
Green	G 
Yellow	Y 
White	W 
Beige	BG 
Dark Brown	DB 

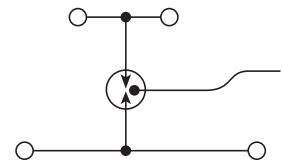
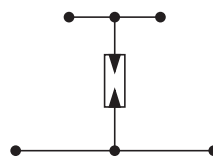

\* Add required voltage to part number as a suffix  
i.e. CDL4U(E)LA/75 is for 75V.

## CDL4U(E)MOV<sup>1</sup>

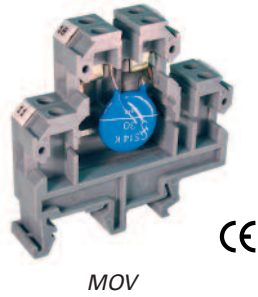

MOV

12 mm

54 x 55.5 mm

9 mm

Polyamide 6.6

4 screw clamps

22-10 AWG

130 V AC\*

-

2kA-6.5kA (8/20  $\mu$ s)

<25ns

10A

100-20,000 pf

For protection from voltage surge, spikes

## CDL4U(E)SD

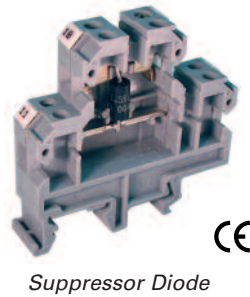

Suppressor Diode

12 mm

54 x 55.5 mm

9 mm

Polyamide 6.6

4 screw clamps

22-10 AWG

12-48V DC / 12-160V AC\*\*

1.5 KA (8/20  $\mu$ s)

-

1 ns DC / 5 ns AC

10A

-

For fine protection of data interfaes, sensors, contacts, etc.

## CDL4U(E)RC

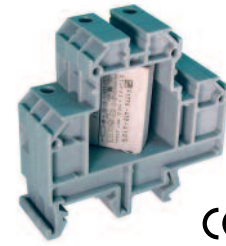

RC Circuit

18 mm

54 x 55.5 mm

9 mm

Polyamide 6.6

4 screw clamps

22-10 AWG

250 V AC / 330 V DC

20A

-

-

10A

0.1  $\mu$ f or 0.22  $\mu$ f<sup>2</sup>

For protection of DC solenoid valves and contactors

Cat. No.	Std. Pk.
CDL4U(E)MOV	20
EPCDL4U	50
CA702	50
CA802	50
MT2	100

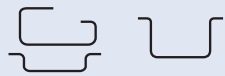

Cat. No.	Std. Pk.
CDL4U(E)SD	20
EPCDL4U	50
CA702	50
CA802	50
MT2	100

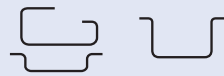

Cat. No.	Std. Pk.
CDL4U(E)RC	10
EPCDL4U	50
CA702	50
CA802	50
MT2	100

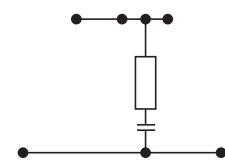
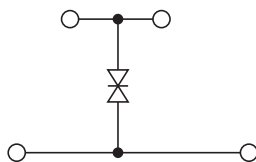
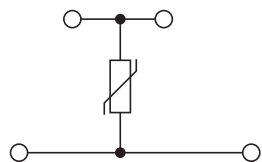
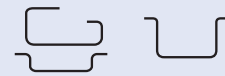

<sup>1</sup> A fuse block is recommended to protect MOV terminals by disconnecting the faulted varistor. See pages 28-30 for fuse blocks.

\* Other voltages available upon request. Call Altech for voltage selection.

\*\* Phase to Phase / Phase to ground. Call Altech for voltage selection.

## TAB, TERMI-POINT® TERMINAL BLOCKS

CTC4U Tab Connection terminals offer quick connection. Connection is achieved by pushing the lug onto the tab blade of the terminal block. The terminal housing is so designed that the wall protrudes beyond the tab blades.

The CTS4U-TM single level and the CDL4U-TM double level terminal blocks have a provision for clip connection according to DIN 41611-4. Three wires (0.5 sq. mm) can be connected with a clip onto the pin using a special tool (*contact Altech for information*). These terminal blocks provide high wiring density without extension of the mounting rail.

CTC4U is used primarily in railway systems. The CTS4U-TM and the CDL4U-TM is used mostly in the telecommunications industry.

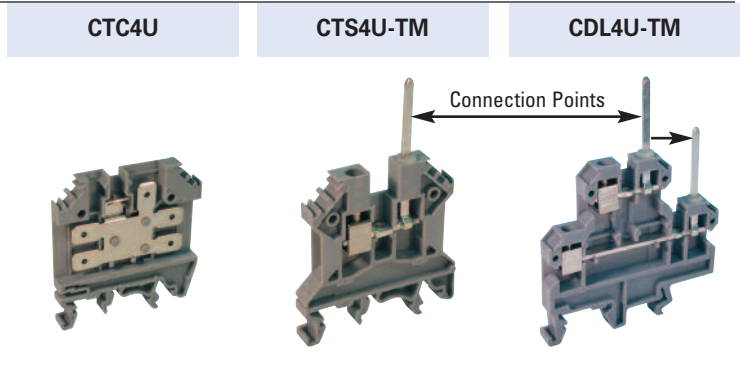
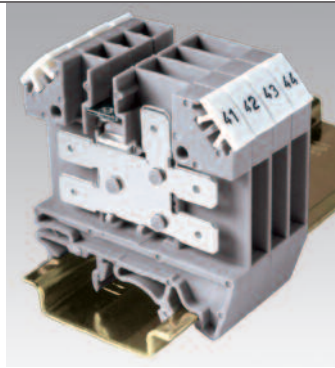

Terminal Width	6 mm		6 mm		6 mm	
Height x Length	49.5 x 47 mm		67 x 43 mm		84 x 55.5 mm	
Stripping Length	9 mm		9 mm		9 mm	
Insulation Material	Polyamide 6.6		Polyamide 6.6		Polyamide 6.6	
Type of Connection	5 tab connection points and 1 tapped hole for cross connection		1 screw connection and 1 blade for 3 (0.5 sq. mm) connections		2 screw connections and 2 blades for 6 (0.5 sq. mm) connections	
Approvals						
Rated Cross Section	0.5-4 sq.mm	22-12 AWG	0.5-4 sq.mm	22-12 AWG	0.5-4 sq.mm	22-12 AWG
Voltage Rating	250 V	300 V	250 V	300 V	250 V	300 V
Current Rating	32 A	25 A	10 A	10 A	10 A	10 A
Tab Blade Size (mm)	6.3 x 0.8	6.3 x 0.8	0.8 x 1.6	0.8 x 1.6	0.8 x 1.6	0.8 x 1.6

			Cat No.	Std. Pk.	Cat No.	Std. Pk.	Cat No.	Std. Pk.
Terminal Block			CTC4U	100	CTS4U-TM	100	CDL4U-TM	100
End Plate			EPCTC4U	50	EP2.5/4UN	50	EPCDL4U	50
DIN Rail								
<i>for ordering information refer to page 62</i>								
End Stop								
<i>for ordering information refer to page 63</i>								
Internal Jumper		2 way	CA727/2	100	CA722/2	100	CA727/2	10
		3 way	CA727/3	50	CA722/3	50	CA727/3	10
		4 way	CA727/4	50	CA722/4	50	CA727/4	10
		10 way	CA727/10	10	CA722/10	10	CA727/10	10
		Insulated Internal Jumper		2 way	CA747/2	100	CA742/2	100
		3 way	CA747/3	50	CA742/3	50	CA747/3	50
		4 way	CA747/4	50	CA742/4	50	CA747/4	50
		10 way	CA747/10	10	CA742/10	10	CA747/10	10
Current Bars		2 way	CA703/1	100	CA703/1	100	CA703/1	100
		3 way	CA704/1	100	CA704/1	100	CA704/1	100
		4 way	CA705/1	100	CA705/1	100	CA705/1	100
		10 way	CA732/10	100	CA732/10	100	CA732/10	100
		10 pole (breakable)	CA732/10-A	100	CA732/10-A	100	CA732/10-A	100
		100 pole	CA732/100	10	CA732/100	10	CA732/100	10
Shorting Sleeve & Screw			CA607/S/Q	100	CA707/S/Q/01	100	CA607/S/Q	100
External Jumper		2 pole			CA713/2	100	CA714/2	100
		3 pole			CA713/3	100	CA714/3	100
		4 pole			CA713/4	50	CA714/4	50
		10 pole			CA713/10	25	CA714/10	25
		Marking Tags (MT Type)			MT6	100	MT6	100



**COLOR BLOCKS**  
(other than grey standard)

**When ordering please add color suffix to Cat. No.**

**Example: CTS2.5U-N/R**

Color	Ordering Suffix
Red	R
Blue	BU
Black	BL
Orange	O
Green	G
Yellow	Y
White	W
Beige	BG
Dark Brown	DB

## HIGH TEMPERATURE CERAMIC EUROBLOCKS™

Suitable for use in high temperature applications up to 600°C (1112°F). Applications include hot melt glue guns, furnaces, heaters, process equipment and machinery. Terminal blocks are offered with mounting holes for panel mounting or free floating applications.

- Compact, space saving
- Tubular screw clamp
- Free float or panel mount
- Temperature range: 600°C (1112°F)
- Standard color: white
- Material

Housing: ceramic  
Clamp: brass  
Screws: zinc plated steel



Insulation Material	Ceramic		Ceramic		Ceramic	
Approvals						
Wire Range	24-12 AWG	24-12 AWG	22-10 AWG	20-10 AWG	20-6 AWG	18-6 AWG
Voltage Rating	300V	300V	300V	300V	300V	300V
Current Rating	30 A	20 A	40 A	30 A	76 A	65 A
No. of Poles	Cat. No.	Std. Pk.	Cat. No.	Std. Pk.	Cat. No.	Std. Pk.
1 (free floating)	CB4/1	50	CB6/1	50		
2 (free floating)	CB4/2	50				
2 (with mounting holes)	CB4/2H	50	CB6/2H	50	CB16/2H	50
3 (free floating)	CB4/3	50				
3 (with mounting holes)	CB4/3H	50	CB6/3H	50	CB16/3H	50

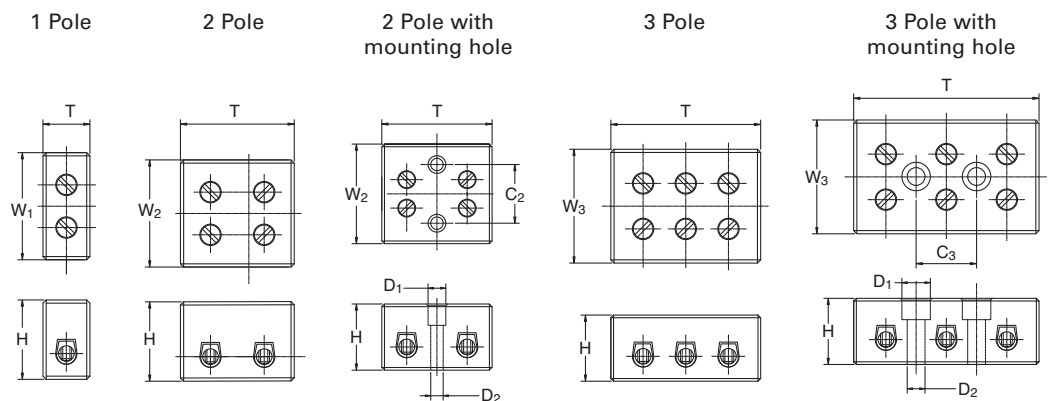

Dimensions mm

		W	T	H	C	D1	D2	Fixing Screw	Stripping Length
CB4/1	1 POLE	23	11	18.5	*				6
CB4/2	2 POLE	23	18	18.5	*				6
CB4/2H	2 POLE	23	24	18.5	14.6	6	3.5	M3X16	6
CB4/3	3 POLE	25	25	18.5	*				6
CB4/3H	3 POLE	25.4	36	18.5	13	6	3.5	M3X16	6
CB6/1	1 POLE	25	12	19.5	*				6
CB6/2H	2 POLE	25.5	26	19.5	12.6	6		M3X16	6
CB6/3H	3 POLE	25.5	41	19.5	15	6		M3X16	6
CB16/2H	2 POLE	28	31	23.2	16.5	6	3.5	M3X20	8.5
CB16/3H	3 POLE	27.5	48	23.2	17	6	3.5	M3X20	8.5

Note: All dimensions are shown in mm, to convert to inches please divide by 25.4.

## MINI FEED-THROUGH

### 15mm DIN Rail

For wire-to-wire connecting in control, automation, instrumentation and power distribution applications.

Altech "miniature" terminal blocks offer tremendous space advantage as demanded by certain wiring configurations.

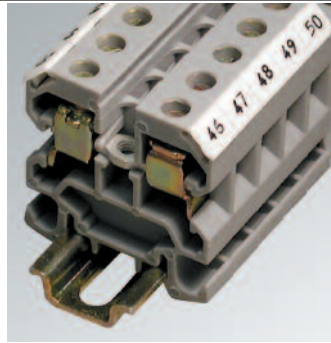

## FUSE BLOCKS

Certain electrical and control systems require protection by fuses. The terminal has a hinged carrier that has a specially designed space for a cartridge type glass fuse of size Ø5 x 20 or Ø5 x 25 mm. The fuse can be engaged or disengaged by the movement of the carrier.

Altech fuse terminals are also available with light indication - CSFL 4U (L). A specially designed built-in circuit gives light indication in the event of fuse blow out.

† Fuses are sold separately  
Altech, see page 34  
for details.



## COLOR BLOCKS

(other than grey standard)

When ordering please add color suffix to Cat. No.

Example: CTS2.5U-N/R

Color	Ordering Suffix
Red	R
Blue	BU
Black	BL
Orange	O
Green	G
Yellow	Y
White	W
Beige	BG
Dark Brown	DB

\* Add required voltage to part number as a suffix, i.e. CSFL4U(L)/24 fo 24V DC

## CMT4



CE



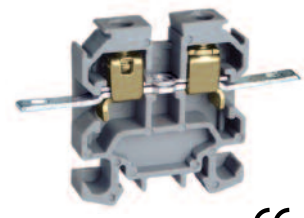





## CMT4S

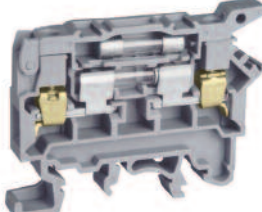
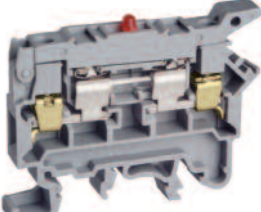

CE

Terminal Width	6 mm			6 mm		
Height x Length	29 x 27 mm			29 x 46 mm		
Stripping Length	9 mm			9 mm		
Insulation Material	Polyamide 6.6			Polyamide 6.6		
Type of Connection	2 screw clamps & 1 tapped hole for cross connection			2 screw clamps, 2 solder points and 1 tapped hole for cross connection		
Type of Fuse Used	—			—		
Approvals						
Wire Range	22-10 AWG	0.5-4 sq.mm	22-10 AWG	22-12 AWG	Upto 1.5 sq.mm	22-10 AWG
Voltage Rating	300 V	400 V	300 V	300 V	160 V	300 V
Current Rating	35 A	32 A	35 A	25 A	15 A	35 A
Torque	6 lb-in	0.5 Nm	7 lb-in	7 lb-in	0.5 Nm	7 lb-in

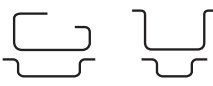
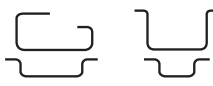
		Cat. No.	Std. Pk.	Cat. No.	Std. Pk.
Terminal Block		CMT4	100	CMT4S	50
End Plate		EPCMT4	50	EPCMT4	50
Isolation Partition		PPCMT4	50	PPCMT4	50
DIN Rail	for ordering information refer to page 62		15 mm		15 mm
End Stop	for ordering information refer to page 63	CA602	100	CA602	50
Internal Jumper	2 pole 3 pole 4 pole 10 pole	CA727/2 CA727/3 CA727/4 CA727/10	100 50 50 10	CA727/2 CA727/3 CA727/4 CA727/10	100 50 50 10
Insulated Internal Jumper	2 pole 3 pole 4 pole 10 pole	CA747/2 CA747/3 CA747/4 CA747/10	100 50 50 10	CA747/2 CA747/3 CA747/4 CA747/10	100 50 50 10
Current Bars	2 pole 3 pole 4 pole 10 pole 10 pole (breakable) 100 pole	CA703/1 CA704/1 CA705/1 CA732/10 CA732/10-A CA732/100	100 100 100 100 100 10	CA703/1 CA704/1 CA705/1 CA732/10 CA732/10-A CA732/100	100 100 100 100 100 10
Shorting Sleeve & Screw		CA607/S/Q	100	CA607/S/Q	100
External Jumper	2 pole 3 pole 4 pole 10 pole	CA714/2 CA714/3 CA714/4 CA714/10	100 100 50 25	CA714/2 CA714/3 CA714/4 CA714/10	100 100 50 25
Marking Tags (MT Type) (MT Type on Lever)		MT2	100	MT2	100

CMT4SU			CSFL4U			CSFL4U(L)*			CGMT4		
											
CE			† Fuse not included.			† Fuse not included.			CE		
6 mm			8 mm			8 mm			6 mm		
29 x 35.5 mm			43 x 58 mm			43 x 58 mm			28.5 x 27 mm		
9 mm			9.5 mm			9.5 mm			9 mm		
Polyamide 6.6			Polyamide 6.6			Polyamide 6.6			Polyamide 6.6		
2 uneven level solder points & 1 tapped hole for cross connection			2 screw clamps			2 screw clamps			2 screw clamps		
—			Ø5x20, Ø5x25mm			Ø5x20, Ø5x25mm			—		
											
22-14 AWG Upto 1.5 sq.mm 22-14 AWG			22-10 AWG 0.5-4 sq.mm 22-10 AWG			22-10 AWG 0.5-4 sq.mm 22-10 AWG			22-10 AWG 0.5-4 sq.mm 22-10 AWG		
300 V 160 V 300 V			600 V 600 V 600 V			600 V 600 V 600 V					
15 A 15 A 20 A			6.3 A 6.3 A 8 A			6.3 A 6.3 A 8 A					
— — —			7 lb-in 0.5 Nm 7 lb-in			7 lb-in 0.5 Nm 7 lb-in			7 lb-in 0.5 Nm 7 lb-in		
Cat. No.	Std. Pk.		Cat. No.	Std. Pk.		Cat. No.	Std. Pk.		Cat. No.	Std. Pk.	
CMT4SU	100		CSFL4U	100		CSFL4U(L)*	100		CGMT4	50	
EPCMT4	50		EPCSFL4U	50		EPCSFL4U	50				
PPCMT4	50		PPCSFL4U	50		PPCSFL4U	50				
											
CA602	50		CA602	100		CA602	100				
CA727/2	100										
CA727/3	50										
CA727/4	50										
CA727/10	10										
CA747/2	100										
CA747/3	50										
CA747/4	50										
CA747/10	10										
CA703/1	10										
CA704/1	10										
CA705/1	10										
CA732/10	10										
CA732/10-A	100										
CA732/100	10										
CA607/S/Q	10										
			CA711/2	100		CA711/2	100				
			CA711/3	100		CA711/3	100				
			CA711/4	50		CA711/4	50				
			CA711/10	25		CA711/10	25				
MT2	100		MT8	100		MT8	100		MT2	100	
			MT2	100		MT2	100				

## MINI FEED-THROUGH

### Panel Mount

For use when space constraints require extremely compact solutions and internal jumping is required.

Individual components can be used to build your own assemblies. Just snap the required number of terminal block components together and place a Mounting Section on each end.

The CMB 4 accepts internal jumpers and standard marking tags.

- Extremely compact and cost effective
- High density
- Screw-cage clamp
- Internal jumping provision
- Polyamide 6.6
- Standard color: gray



## CMB4

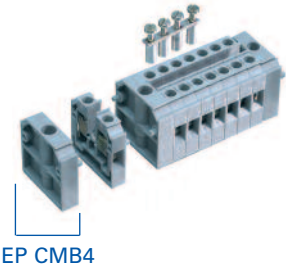

EP CMB4



Terminal Width	6 mm		
Height x Length	28 x 27 mm		
Stripping Length	9 mm		
Insulation Material	Polyamide 6.6		
Type of Connection	2 screw clamps & 1 tapped hole for cross connection		
Approvals	  		
Wire Range	22-10 AWG	0.5-4 sq.mm	22-10 AWG
Voltage Rating	300 V	400 V	300 V
Current Rating	35 A	32 A	35 A
Torque	7 lb-in	0.5 Nm	7 lb-in

Preassembled blocks are also available for quick and easy installations.  
See Dimensions below.

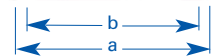
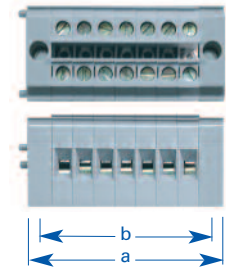

Dimensions mm (in.)  
CMB4

Terminal Block	CMB4	100
Mounting Section	EPCMB4	50
Separator Plate	SPCMB4	100

Mounting Screw*			
Internal Jumper		2 pole	CA727/2 100
		3 pole	CA727/3 50
		4 pole	CA727/4 50
		10 pole	CA727/10 10

Insulated Internal Jumper		2 pole	CA747/2 100
		3 pole	CA747/3 50
		4 pole	CA747/4 50
		10 pole	CA747/10 10

Current Bars		2 pole	CA703/1 100
		3 pole	CA704/1 100
		4 pole	CA705/1 100
		10 pole	CA732/10 100
		10 pole (breakable)	CA732/10-A 100
		100 pole	CA732/100 10

Shorting Sleeve & Screw		CA607/S/Q 100
-------------------------	---	---------------

External Jumper		2 pole	CA714/2 100
		3 pole	CA714/3 100
		4 pole	CA714/4 50
		10 pole	CA714/10 25

Marking Tags (MT Type)		MT2 100
------------------------	---	---------

Cat No.	No. of Poles	Width (a)	Hole Spacing (b)
CMB4/2	2	26 (1.02)	19 (0.75)
CMB4/3	3	32 (1.26)	25 (0.98)
CMB4/4	4	38 (1.50)	31 (1.22)
CMB4/5	5	44 (1.73)	37 (1.46)
CMB4/6	6	50 (1.97)	43 (1.69)
CMB4/7	7	56 (2.20)	49 (1.93)
CMB4/8	8	62 (2.44)	55 (2.17)
CMB4/9	9	68 (2.68)	61 (2.40)
CMB4/10	10	74 (2.91)	67 (2.64)
CMB4/11	11	80 (3.15)	73 (2.87)
CMB4/12	12	86 (3.39)	79 (3.11)
CMB4/13	13	92 (3.62)	85 (3.35)
CMB4/14	14	98 (3.86)	91 (3.58)
CMB4/15	15	104 (4.09)	97 (3.82)
CMB4/16	16	110 (4.33)	103 (4.06)
CMB4/17	17	116 (4.57)	109 (4.29)
CMB4/18	18	122 (4.80)	115 (4.53)
CMB4/19	19	128 (5.04)	121 (4.76)
CMB4/20	20	134 (5.28)	127 (5.00)
CMB4/21	21	140 (5.51)	133 (5.24)
CMB4/22	22	146 (5.75)	139 (5.47)
CMB4/23	23	152 (5.98)	145 (5.71)
CMB4/24	24	158 (6.22)	151 (5.94)

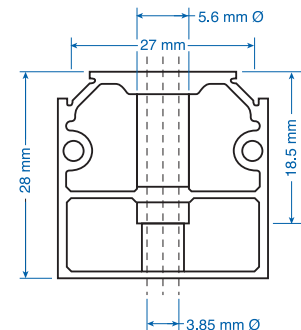

Mounting Section  
EPCMB4



## COLOR BLOCKS

(other than grey standard)

When ordering please add color suffix to Cat. No.

Example: CTS2.5U-N/R

Color	Ordering Suffix
Red	R
Blue	BU
Black	BL
Orange	O
Green	G
Yellow	Y
White	W
Beige	BG
Dark Brown	DB

\* Any length M3 screw may be used.

## BUSBAR SYSTEM

### Panel Mount

A quick reliable solution for ground, neutral or low voltage distribution applications. The Busbar System consists of a busbar, busbar supports, and screw clamp terminals for terminating wires

NEB 10 (10 x 3 mm) and NEB 6 (6 x 6 mm), tin plated copper busbars are available in one meter lengths. Both have a 140A current carrying capacity.

NES plastic support with fixing screws for holding 10 x 3 & 6 x 6 busbar makes placing of busbar an easy task. Busbars up to 200 mm length should be supported at ends by two busbar supports. For busbars exceeding 200 mm length, it is recommended to provide intermediate busbar support. Easy to operate CENC clamp secures wire to the busbar.



	CENC4	CENC16	CENC35
Terminal Width	7.5 mm	9.8 mm	14.5 mm
Height x Length	30 x 23.3 mm	36 x 23.3 mm	45 x 27.3 mm
Stripping Length	12 mm	16 mm	16 mm
Insulation Material	Polyamide 6.6	Polyamide 6.6	Polyamide 6.6
Type of Connection	1 screw clamp connection	1 screw clamp connection	1 screw clamp connection
Approvals			
Wire Range	22-12 AWG 0.5-6 sq.mm 22-12 AWG	9-6 AWG 6-16 sq.mm 10-6 AWG	7-2 AWG 10-35 sq.mm 8-2 AWG
Current Rating*	25 A 41 A	76 A 76 A	125 A 125 A
Torque	14 lb-in 0.8 Nm 14 lb-in	14 lb-in 2.0 Nm 17.5 lb-in	25 lb-in 2.5 Nm 25 lb-in

	Cat. No.	Std. Pk.	Cat. No.	Std. Pk.	Cat. No.	Std. Pk.
Terminal Block Green Cap **	CENC4	50	CENC16	50	CENC35	50
Busbar (10 x 3 mm)	NEB10	1 m	NEB10	1 m	NEB10	1 m
Busbar (6 x 6 mm)	NEB6	1 m	NEB6	1 m	NEB6	1 m
Plastic Support with Fixing Screw	NES	50	NES	50	NES	50
End Clamp/Bus bar support for rail mounting	CA202	50	CA202	50	CA202	50
Marking Tags (MT Type)	MT5	100	MT6	100	MT6	100

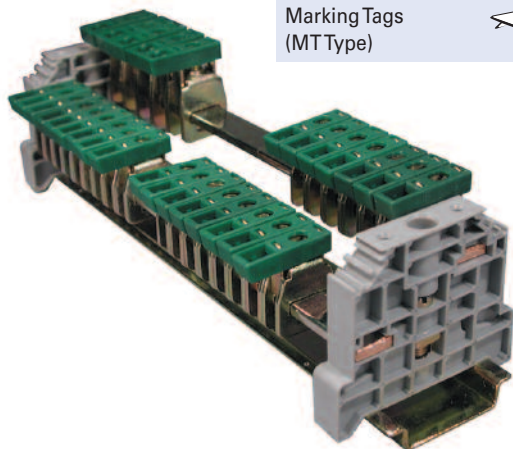

\* 140A current carrying capacity of busbar should be taken into account while connecting loads.

\*\* Consult for other available colors.