

ACDSW4148-G

Reverse Voltage: 100 V

Forward Current: 150mA

RoHS Device

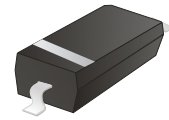

Features

- Fast switching speed
- High speed
- High conductance
- Surface mount package ideally suited for automatic insertion
- For general purpose switching applications
- Comply with AEC-Q101

Mechanical data

- Case: SOD-123, Molded Plastic
- Terminals: Solderable per MIL-STD-750, method 2026.
- Weight: 0.0097 grams(approx.).

Circuit diagram

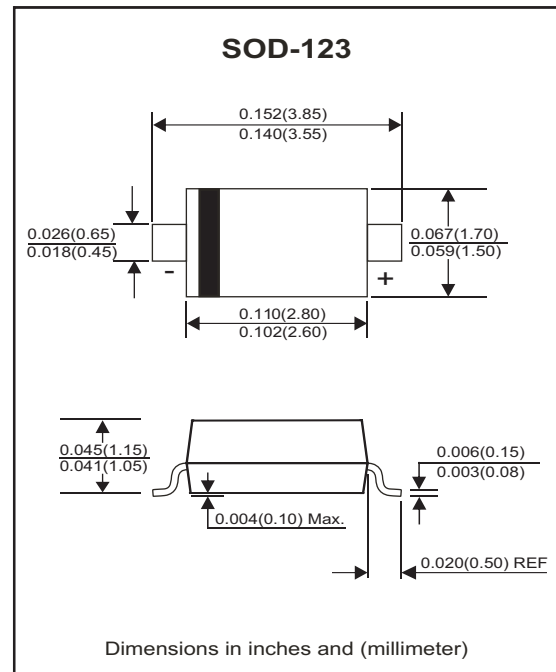

Maximum Rating (at Ta=25°C unless otherwise noted)

Parameter	Symbol	Value	Unit
Peak repetitive peak reverse voltage	VRRM	100	V
Working peak reverse voltage	VRWM		
DC blocking voltage	VR		
RMS reverse voltage	VR(RMS)	71	V
Average rectified output current	Io	150	mA
Non-Repetitive peak forward surge current @t=1µs	IFSM	2	A
Power dissipation	PD	350	mW
Thermal resistance from junction to ambient	RθJA	250	°C/W
Junction temperature range	Tj	-40~+150	°C
Storage temperature range	TSTG	-55~+150	°C

Electrical Characteristics (at Ta=25°C unless otherwise noted)

Parameter	Conditions	Symbol	Min	Typ	Max	Unit
Forward voltage	$I_F = 1 \text{ mA}$	V_{F1}			0.715	V
	$I_F = 10 \text{ mA}$	V_{F2}			0.855	V
	$I_F = 50 \text{ mA}$	V_{F3}			1.0	V
	$I_F = 150 \text{ mA}$	V_{F4}			1.25	V
Reverse current	$V_R = 20 \text{ V}$	I_{R1}			25	nA
	$V_R = 75 \text{ V}$	I_{R2}			1	μA
Capacitance between terminals	$f = 1 \text{ MHz}$ and $V_R = 0 \text{ V}$	C_J			2	pF
Reverse recovery time	$I_F = I_R = 10 \text{ mA}$, $R_L = 100 \Omega$, $I_{rr} = 0.1 \times I_R$	T_{RR}			4	nS

Typical Characteristics (ACDSW4148-G)

Fig.1 - Forward Characteristics

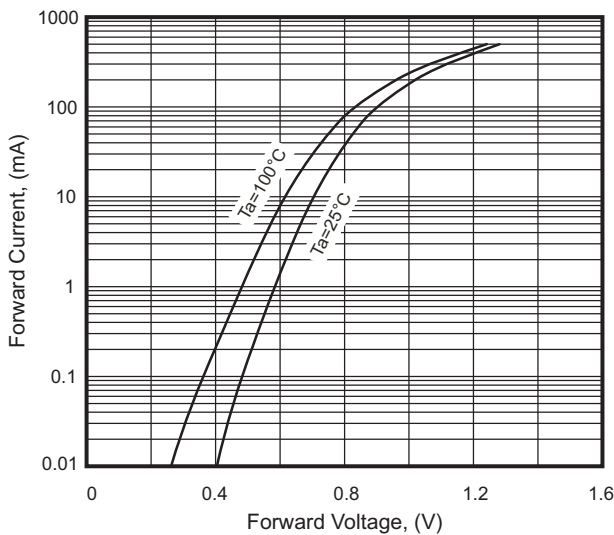

Fig.2 - Reverse Characteristics

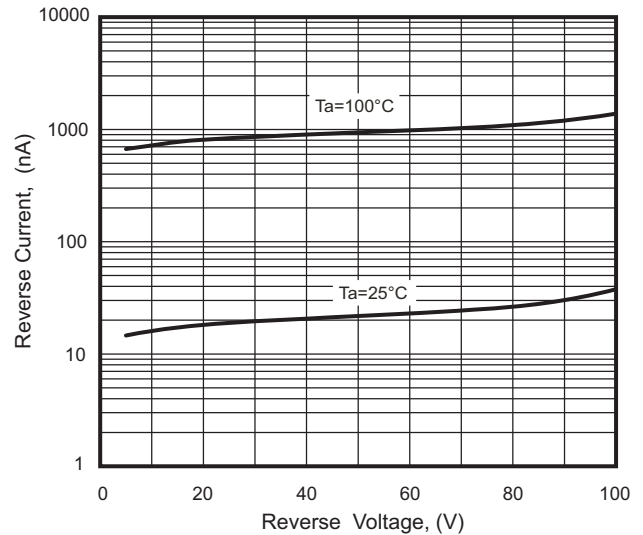

Fig.3 - Capacitance Characteristics

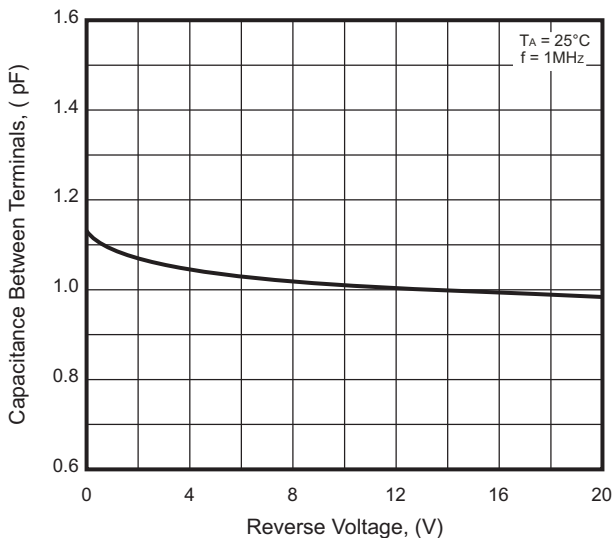
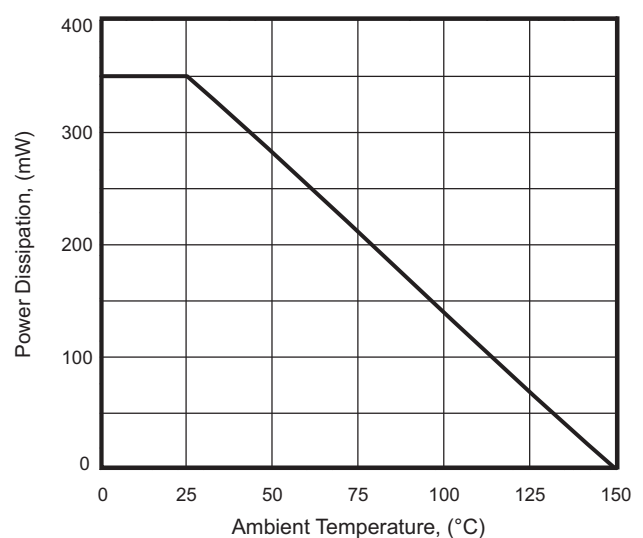
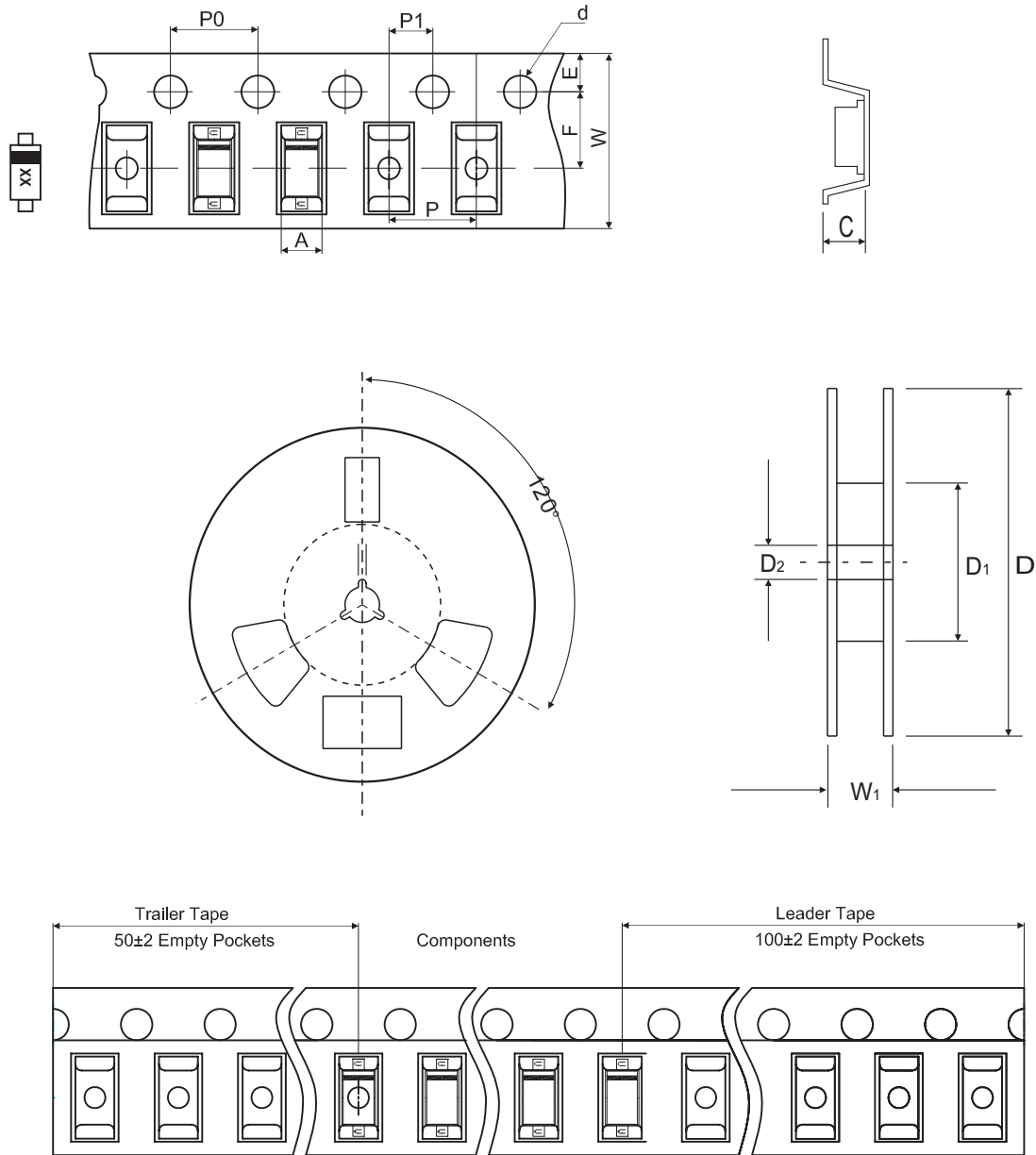

Fig.4 - Power Derating Curve



Reel Taping Specification



SOD-123	SYMBOL	A	B	C	d	D	D ₁	D ₂
	(mm)	1.85 ± 0.05	3.94 ± 0.05	1.57 ± 0.05	1.55 ± 0.10	178.00 ± 2.00	54.40 ± 1.00	13.00 ± 1.00
	(inch)	0.073 ± 0.002	0.155 ± 0.002	0.062 ± 0.002	0.061 ± 0.004	7.008 ± 0.079	2.142 ± 0.039	0.512 ± 0.039

SOD-123	SYMBOL	E	F	P	P ₀	P ₁	W	W ₁
	(mm)	1.75 ± 0.10	3.50 ± 0.10	4.00 ± 0.10	4.00 ± 0.10	2.00 ± 0.10	8.00 + 0.30 / - 0.10	12.30 ± 1.00
	(inch)	0.069 ± 0.004	0.138 ± 0.004	0.157 ± 0.004	0.157 ± 0.004	0.079 ± 0.004	0.315 + 0.012 / - 0.004	0.484 ± 0.039

Company reserves the right to improve product design , functions and reliability without notice.

REV:A

Marking Code

Part Number	Marking Code
ACDSW4148-G	T4



xx = Product type marking code

Suggested PAD Layout

SIZE	SOD-123	
	(mm)	(inch)
A	3.24	0.128
B	0.80	0.031
C	1.00	0.039
D	4.04	0.159
E	2.44	0.096

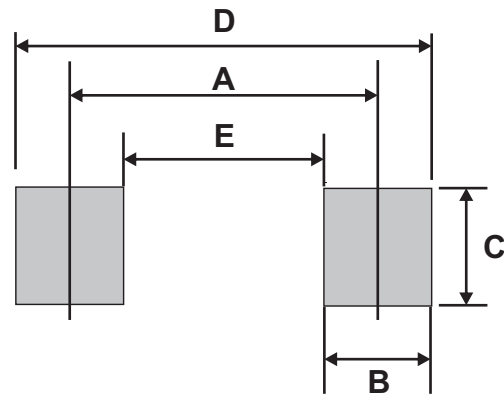

Standard Packaging

Case Type	REEL PACK	
	REEL (pcs)	Reel Size (inch)
SOD-123	3,000	7