

Applications

- WiFi bandpass filter that enables the coexistence of 4G (WiMAX/LTE/TD-LTE) & WiFi signals
- Handsets
- Portable Hotspots
- Mobile Routers
- Smart Meters
- High-power WLAN Access Points
- Applicable reject bands: 2.6 GHz WiMAX/LTE, LTE Band 7

Product Features

- Low Loss in WLAN band with extended upper corner for inclusion of Bluetooth
- High Rejection in B7/B41 bands
- Industry leading small size: 1.1 x 0.9 x 0.5 mm
- Performance over -30 to +85 °C
- Single Ended operation
- RoHS compliant, Pb-free module package

General Description

The 885171 is a high-performance, high power Bulk Acoustic Wave (BAW) band-pass filter with extremely steep skirts, simultaneously exhibiting low loss in the WiFi band and high near-in rejection in the 2.6GHz bands.

885171 is specifically designed to enable coexistence of WiFi and LTE signals within the same device or in close proximity to one another.

The 885171 uses common module packaging techniques to achieve the industry standard 1.1 x 0.9 x 0.50 mm footprint. The filter exhibits excellent power handling capabilities.

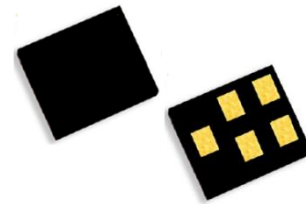

1.1x0.9x0.50mm

Functional Block Diagram

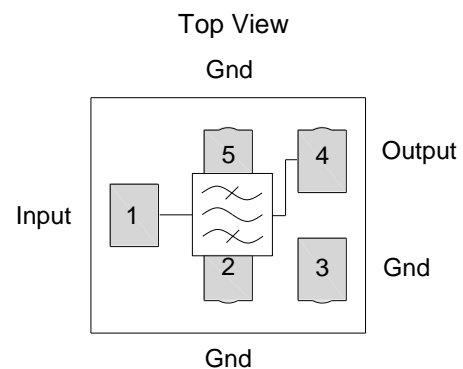

Pin Configuration

Pin No.	Label
1	Input
4	Output
2,3,5	Ground

Ordering Information

Part No.	Description
885171	Packaged part
885171-EVB	Evaluation board

Standard T/R size = 15,000 units/reel

Absolute Maximum Ratings

Parameter	Rating
Storage Temperature ⁽¹⁾	-40 to +85°C
Operable Temperature ⁽²⁾	-30 to +85°C
Absolute Maximum Input Power ⁽³⁾	37dBm

1. Operation of this device outside the parameter ranges given may cause permanent damage.
2. Specifications are not guaranteed over all operable conditions.
3. Max CW signal applied for up to 500mSec with no damage

Electrical Specifications ^(1, 4)

Conditions unless otherwise noted: Device Temperature = -30°C to +85°C.

Parameter	Conditions	Min	Typ (+25°C)	Max	Units
Insertion Loss ⁽²⁾	2402.5 – 2421.5 MHz (WiFi Ch.1)	-	1.6	1.9	dB
	2407.5 – 2426.5 MHz (WiFi Ch.2)		1.3	1.7	
	2412.5 – 2471.5 MHz (WiFi Ch.3-11)		1.5	2.0	
	2457.5 – 2476.5 MHz (WiFi Ch.12)		1.7	2.2	
	2462.5 – 2481.5 MHz (WiFi Ch.13)		1.9	2.8	
Passband Ripple	2402.5 – 2421.5 MHz (WiFi Ch.1)	-	0.8	1.3	dB
	2407.5 – 2426.5 MHz (WiFi Ch.2)		0.8	1.2	
	2412.5 – 2471.5 MHz (WiFi Ch.3-11)		0.8	1.2	
	2457.5 – 2476.5 MHz (WiFi Ch.12)		0.9	1.6	
	2462.5 – 2481.5 MHz (WiFi Ch.13)		1.0	3.0 ⁽⁶⁾	
VSWR, In & Out	2402 – 2478 MHz (WiFi Ch.1-12)	-	1.9	2.1	-
	2461 – 2483 MHz (WiFi Ch.13)		1.8	2.7 ⁽⁶⁾	
Rejection/Attenuation	699 – 960 MHz	30.0	40.0	-	dB
	1425 – 2170 MHz	30.0	35.0	-	dB
	2300 – 2370 MHz ⁽³⁾	45.0	50.0	-	dB
	2370 – 2380 MHz ⁽³⁾	24.0	25.0	-	dB
	2496 – 2501 MHz (+25 to +85°C) ⁽³⁾	32.0	50.0	-	dB
	2496 – 2501 MHz (-30 to +25°C) ⁽³⁾	20.0	50.0	-	dB
	2500 – 2505 MHz (+25 to +85°C) ⁽³⁾	50.0	55.0	-	dB
	2500 – 2505 MHz (-30 to +25°C) ⁽³⁾	40.0	55.0	-	dB
	2505 – 2570 MHz (+25 to +85°C) ⁽³⁾	45.0	50.0	-	dB
	2505 – 2570 MHz (-30 to +25°C) ⁽³⁾	45.0	50.0	-	dB
	2570 – 2620 MHz ⁽³⁾	40.0	45.0	-	dB
	2620 – 2690 MHz ⁽³⁾	40.0	45.0	-	dB
	4900 – 5805 MHz	30.0	44.0	-	dB
7200 – 7500 MHz	38.0	45.0	-	dB	
RF Input Power ⁽⁵⁾	2400 – 2481.5 MHz	27			dBm

Notes:

1. In production, devices will be tested at room temperature to a guard-banded specification to ensure electrical compliance over temperature
2. Data is the integrated value of the linear s-parameter over the indicated band at the specified temperature.
3. Data is the integrated value of the linear s-parameter over 5MHz range at the specified temperature.
4. An external impedance matching network with ±2% tolerance will be necessary to achieve the stated specifications.
This is the optimum impedance in order to achieve the performance shown
5. Input power applied for a minimum of 5,000 hrs at 55°C in the frequency band specified.
6. CH13 at room temperature

Evaluation Board

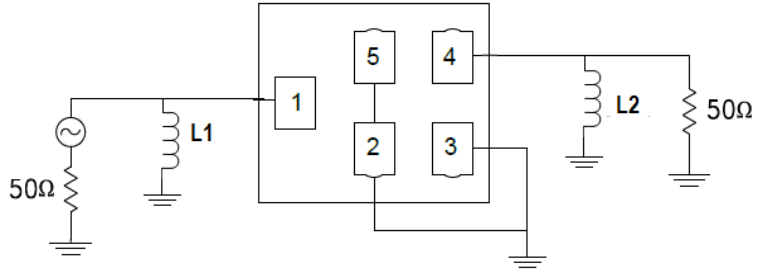
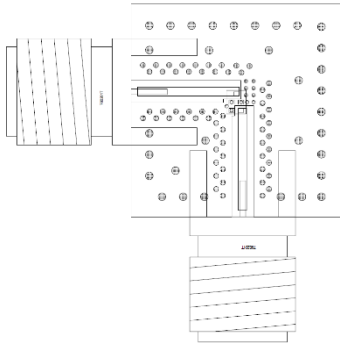

Notes:

1. Matching component values shown are for the specified TriQuint evaluation board. Value adjustment may be required in end user product circuits depending on component manufacturer and PCB material.

Bill of Material

Reference Des.	Value	Description	Manuf.	Part Number
L1	8.2nH	Chip inductor, 0201,+/- 2%	Murata	
L2	7.5nH	Chip inductor, 0201,+/- 2%	Murata	
PCB	N/A	3 layer	Multiple	960999 Rev -

Performance Plots

Test conditions unless otherwise noted: Temp= +25°C

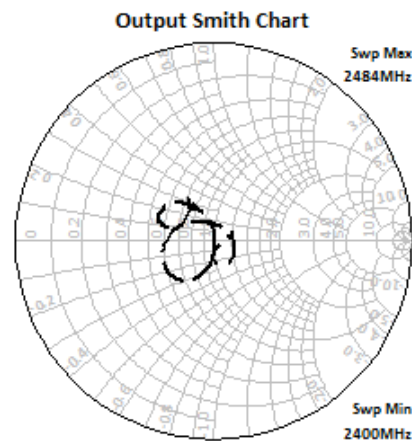
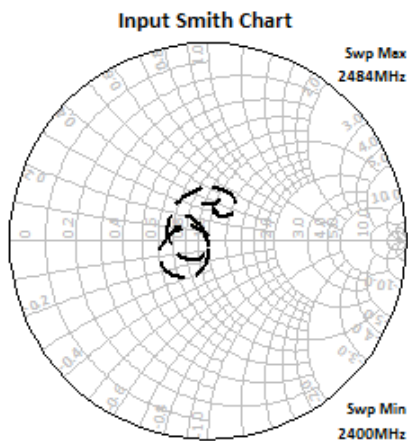
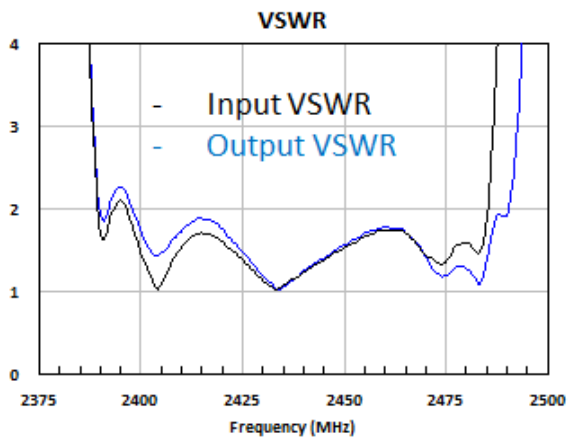
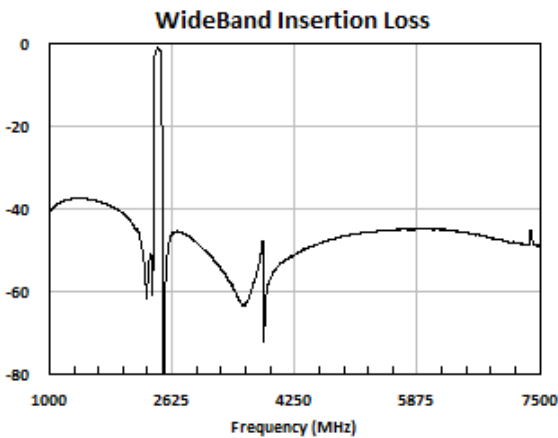
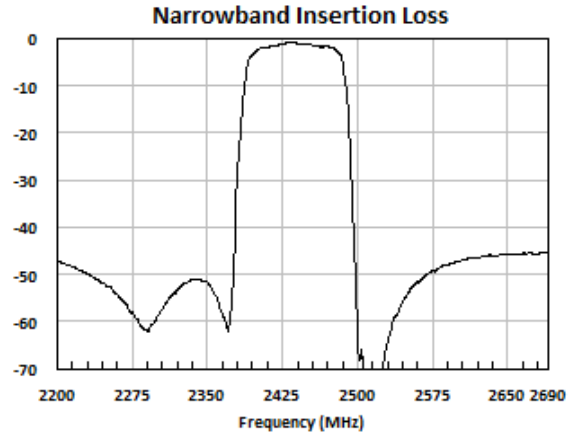
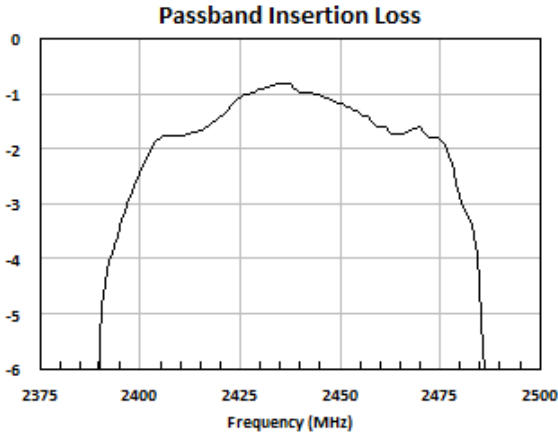

Package Information, Marking and Dimensions

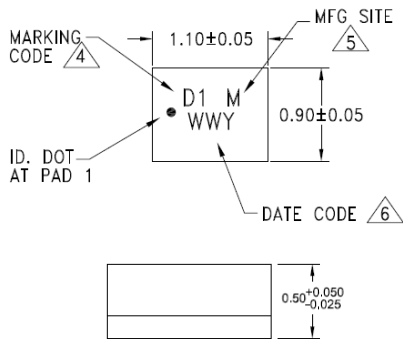

Package Style: CSP
Dimensions: 1.1 x 0.9 x 0.50 mm

Package for Surface Mount Technology
Terminations: Au plating 0.5 - 1.0µm, over a 2- 6µm Ni Plating
Approximate weight 1.37mg

Marking Code uniquely identifies Part Number
M = Manufacturing site (Blank for Apopka, C for Costa Rica)
Date code consists of:
WW = 2 digit week,
Y = last digit of year

An asterisk (*) in front of the marking code indicates prototype.

Note:
All dimensions are in millimeters.

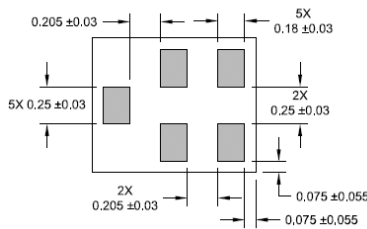

PCB Mounting Pattern

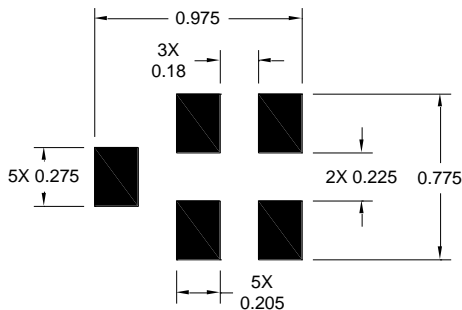

Notes:

1. All dimensions are in millimeters. Angles are in degrees.
2. This drawing specifies the mounting pattern used on the TriQuint evaluation board for this product. Some modification may be necessary to suit end user assembly materials and processes.

Tape and Reel information

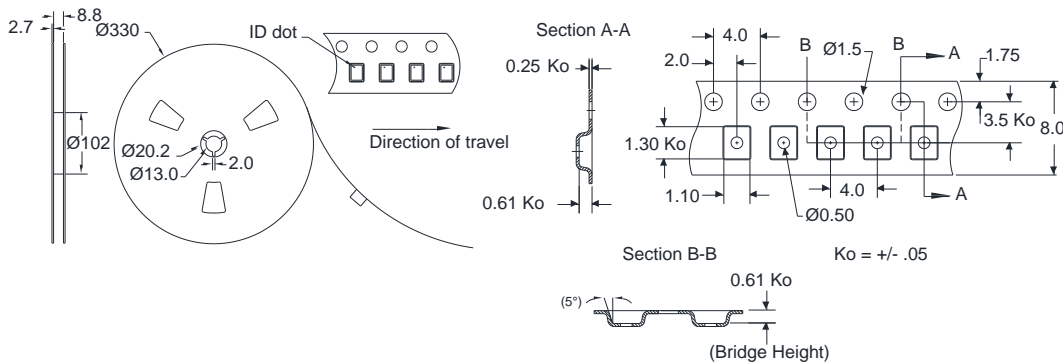

Standard T/R size = 15,000 units/reel. All dimensions are in millimeters

Product Compliance Information

ESD Sensitivity Ratings



Caution! ESD-Sensitive Device

ESD Rating: Class 1A
Test: Human Body Model (HBM)
Standard: JS-001

ESD Rating: Class C3
Test: Charged Device Model (CDM)
Standard: JS-002

MSL Rating

MSL rating: 3

Solderability

Compatible with the latest version of J-STD-020, lead free solder, 260°C

Refer to [Soldering Profile](#) for recommended guidelines.

RoHS Compliance

This part is compliant with EU 2002/95/EC RoHS directive (Restrictions on the Use of Certain Hazardous Substances in Electrical and Electronic Equipment).

This product also has the following attributes:

- Halogen Free (Chlorine, Bromine)
- Antimony Free
- TBBP-A (C₁₅H₁₂Br₄O₂) Free
- PFOS Free
- SVHC Free

Contact Information

For the latest specifications, additional product information, worldwide sales and distribution locations, and information about TriQuint:

Web: www.triquint.com
Email: info-sales@tqs.com

Tel: +1.407.886.8860
Fax: +1.407.886.7061

Important Notice

The information contained herein is believed to be reliable. TriQuint makes no warranties regarding the information contained herein. TriQuint assumes no responsibility or liability whatsoever for any of the information contained herein. TriQuint assumes no responsibility or liability whatsoever for the use of the information contained herein. The information contained herein is provided "AS IS, WHERE IS" and with all faults, and the entire risk associated with such information is entirely with the user. All information contained herein is subject to change without notice. Customers should obtain and verify the latest relevant information before placing orders for TriQuint products. The information contained herein or any use of such information does not grant, explicitly or implicitly, to any party any patent rights, licenses, or any other intellectual property rights, whether with regard to such information itself or anything described by such information.

TriQuint products are not warranted or authorized for use as critical components in medical, life-saving, or life-sustaining applications, or other applications where a failure would reasonably be expected to cause severe personal injury or death.