

Glenair[®]

Qwik Connect

GLEN AIR ■ JULY 2011 ■ VOLUME 15 ■ NUMBER 3

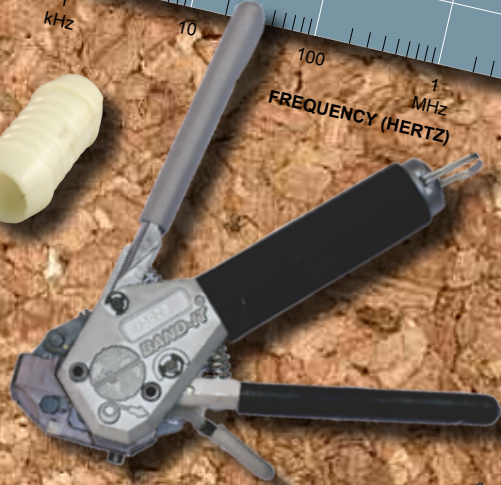
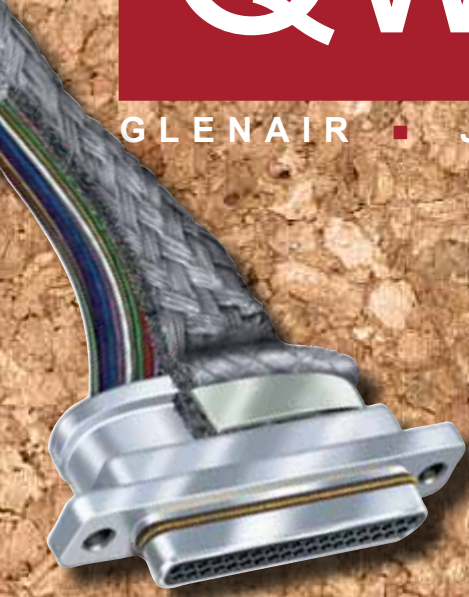

EMI/RFI Braided Shielding Solutions



AmberStrand

ARMORLITE

AIRCRAFT AVIONICS AND EMI

NOISE



Electromagnetic compatibility (EMC) engineers

use the concept of “noise” to describe the unwanted signals that degrade the performance of electronic equipment. In avionics applications, both external and internal sources of EMI noise can jam sensitive navigation and tactical equipment, possibly even disrupting control of the aircraft. An aircraft carrier’s massive electronics bay might cause interference that scuttles a take-off or landing. EMI affecting satellite transmissions can cause communication failures on the battleground. For these reasons, EMI is considered a serious problem, and numerous technologies and techniques have been developed to insure electromagnetic compatibility (EMC) in data transmission systems—from shipboard to undersea, from avionics to space, from aircraft carriers to micro unmanned aerial vehicles.

Sources of EMI

Sources of EMI “noise” can be grouped into three categories: 1) intrinsic noise that arises from random fluctuations within physical systems, such as thermal and shot noise, 2) man-made noise from motors, switches, power supplies, digital electronics and radio



Cockpit avionics are susceptible to multiple sources of EMI including man-made interference from iPhones and other PEDs

transmitters, and 3) noise from natural disturbances such as electro-static discharge (ESD), lightning and sunspots.

Intrinsic

Intrinsic noise sources can be very subtle and often go unrecognized. All electrical systems are potential sources of intrinsic noise, including such common devices as portable radios, MP3 players, cell phones and so on. These devices can cause interference simply by being on. This is because electrons within a conducting media or a semiconductor device create current flow when excited by external voltages. When the externally applied voltage stops, electrons continue to move, randomly interacting with other electrons and with the surrounding material. This random electron motion can create noise in conducting media even without current flow.

Man-made

To protect avionics systems from man-made noise, intentional radio frequency (RF) emitters like cell phones, Bluetooth accessories, CB radios, remote-controlled toys, and walkie-talkies are banned outright on commercial airline flights. Laptops, hand held scanners and game players, while not intentional emitters, can produce signals in the 1 MHz range that can affect performance of avionic equipment. Navigation cabling and other critical wiring runs along the fuselage with passengers sitting just a few feet away. Since the thin sheet of dielectric material that forms the interior of the passenger compartment—typically fiberglass—offers no shielding whatsoever; and since commercial passenger jets contain up to 150 miles of electrical wiring that can behave like a giant antenna, it is extremely important for passengers to heed regulations on the use of potentially disruptive electronic equipment.

Obviously, these internal sources of EMI are quite dangerous to aircraft because they are so close to the systems they might affect. But external sources, such as radio and radar transmitters on the ground, or radar from a passing military plane,

can be even more disruptive due to the high power and frequency of such equipment.

As if the many external and internal sources of EMI were not enough of a concern, the aluminum airframe itself, in certain circumstances, can act as a resonant cavity in the 1 to 10 MHz range. Behaving much like a satellite dish, the airframe can compound the effects of both internal and external EMI by concentrating man made and naturally-occurring transient signals and broadcasting the interference into nearby equipment.

A recently released report from a major aircraft manufacturer illustrates the ongoing concern with passenger-carried portable electronic devices (PED). The number of these devices on commercial airplanes has mushroomed, particularly with the advents of new classes of laptop devices such as the Apple iPad. The use of PEDs produces uncontrolled electromagnetic emissions that have the potential to interfere with avionic systems. While aircraft avionics gear is tested and qualified to rigorous electromagnetic standards PEDs are not subjected to even a fraction of the same testing and qualification regimens for electromagnetic compatibility.

As system speeds have increased, the voltage levels of data signals have necessarily decreased, making them much more susceptible to performance degradation by unwanted electronic noise—particularly the combined noise of large numbers of PED's operating within a single aircraft. A perfect illustration of this phenomenon was experienced by world cup soccer fans in South Africa, where the combined noise from the countless vuvuzelas drowned out all normal communication to the extreme detriment of the games.

The term High Intensity Radiated Fields (HIRF) refers to emissions from radar, microwave, radio, and television transmitters, high power AM/FM radio broadcast systems, TV transmitters and other powerful communications systems. HIRF is considered to be one of the more disruptive forms of EMI. The FAA has issued a Flight Standards Bulletin about the problems of HIRF stating that high powered electromagnetic interference can potentially lead to disruptions in airplane navigation and communication systems and to "loss of aircraft and life."

The frequency bands used by avionic systems span the electromagnetic spectrum from a few kilohertz to several gigahertz. At the low end, Omega Navigation, which is used to fix aircraft position within a network of ground based transmitters, operates in the frequency range of 10 to 14 KHz. VHF Omnidirectional Range Finders (VOR) are radio beacons used in point to point navigation. They operate from 108 to 118 MHz. Glideslope Systems used during landings operate in the 328 to 335 MHz range. Distance-Measuring Equipment (DME), which gauges the space between the aircraft and ground-based transponders operate at just over 1 GHz. Also in the spectrum above 1 GHz are global positioning, collision avoidance, and cockpit weather radar systems.

Personal Electronic Devices (PEDs) operate at frequencies from 10 to 15 KHz for AM radios and up to 400 MHz for laptop computers. When the higher harmonics of these signals are taken into account, the emitted frequencies cover almost the entire range of navigation and communication frequencies used on the aircraft, and PEDs, are just a single class of EMI emitters. When the full spectrum of other radiated and conducted EMI emitters are taken into account, it becomes clear that the entire system of electronic equipment aboard commercial and military aircraft are at risk to EMI.



Naturally Occurring

Naturally occurring noise sources such as ESD, lightning or other energy surges also present significant life safety and equipment damage potential. A poorly grounded device can transmit dangerous energy from a transient surge to a technician, user or any other passerby. Sensitive semiconductors and other components can be damaged or destroyed. Solutions to naturally occurring noise include:

- Eliminate static buildup at the source
- Insulate the device properly
- Provide an alternative path for the discharge or surge to bypass the circuit
- Shield the circuit properly to allow the discharge or surge to drain to ground



The proliferation of personal electronic devices has led to new EMC requirements in commercial aircraft

But the fact that all avionic equipment and cabling which is critical to the functioning of commercial and military aircraft is shielded against EMI, raises an interesting question: how exactly does EMI, such as RFI from a passenger cell phone or iPod permeate the system?

In many cases the cause is simply inadequate shielding, or shielding which has been damaged during servicing or has degraded due to corrosion, thus increasing the resistance of the electrical connection to ground. As effective shielding is dependent on good grounding, any additional resistance in the system—for example at a corroded backshell or a poorly installed shield termination solder sleeve—can enable the wires to pick up interfering signals directly.

Aircraft with navigation and communication antennas located outside the skin of the aircraft can also pick up EMI radiated through passenger windows and other unshielded openings in the plane. The pathway for RFI from a passenger PED would, in this example, be out the window, back into the plane via an unprotected or RFI sensitive antenna, and then directly into a navigation receiver, autopilot computer or other avionic device.

EMI Management

Effective shielding of avionic devices must anticipate both “radiated susceptibility” (the degree to which outside interference affects the reliable functioning of equipment) and “radiated emissions” (the extent to which the device itself creates electromagnetic waves which can affect its function). In both cases, the techniques for managing the interference include reflecting the signals outright, reducing entry points in equipment and cable shields, absorbing the interference in permeable material and dissipating it as heat, or conducting the EMI along the skin of the device/cable and taking it to ground.

In practical terms, EMI management is accomplished by plating the skins of cases and cable shields, building up the density (thickness) of shield material, or eliminating line-of-sight entry points through which electromagnetic waves can penetrate or escape.

The frequency of the interfering signal is a critical concern when designing an effective shielding solution. Low frequency magnetic waves in the 1 to 30 KHz range, for example, are most effectively shielded by absorbing the signals in permeable material. High frequency signals (30 KHz and above) are most effectively shielded by reducing entry windows and by insuring adequate surface conductivity to ground. In interconnect applications, wires and cables are typically shielded by placing a conductive material between the cable conductor and its outer jacket, or by covering individual conductors within a cable with shielding material. Again, the purpose of such shielding is to either capture the EMI and take it to ground or to dissipate the interfering signal as heat.

Shields must also be effectively terminated to the connector backshell lest radiation enter the system at the backshell/connector/shield interface and defeat the purpose of the shield.

In interconnect cable assemblies, conductive wires and cables act as antennas to pick up and/or radiate noise. Cables can couple electrical or magnetic fields, or even radiated energy from another cable (known as “crosstalk”). The most basic of all material requirements is therefore to apply a conductive shielding around cable conductors to take electrical and magnetic field voltages to ground. Braided shielding provides the cable assembly with strength, durability and flexibility with just a slight sacrifice to effectiveness (compared to a solid conduit, conductive tape or other material).

Conductive EMI/RFI Braided Shielding

Electromagnetic interference can be absorbed into permeable conductive materials, such as shielding placed around individual conductors within a cable assembly or wire harness. This shielding material either captures the EMI, taking it to ground, or dissipates it as heat. Metallic braids and high-tech plated fabrics also shield cable conductors from line-of-sight penetration or escape, again by taking EMI to ground.

A wide range of cable shield termination technologies are available—the effectiveness of each style, and the complete shielding solution, can be measured using a transfer impedance test to evaluate the cable shield performance against electrostatic discharge and radiated emissions at various frequencies up to the gigahertz range. Shielding effectiveness can be calculated for a range of frequencies by taking the ratio of transfer impedance for an unprotected device or system compared to transfer impedance of a protected device or system, with the result expressed in decibels. Glenair cable shielding is manufactured in a wide range of designs and configurations. Materials include tin-plated copper, nickel-plated copper and tin-plated iron/copper, nickel-plated stainless steel as well as hybrid materials such as metallized thermoplastic composite material. Each type of shielding has advantages for consideration when selecting the best and most cost-effective option

for a given application.

Braided shields provide exceptional structural integrity while maintaining good flexibility and flex life. They also minimize low-frequency interference at audio and RF ranges. The material's ability to contribute to EMI reduction depends on the signal amplitude and frequency in relation to braid mesh count, wire diameter and material. Generally, the tighter the mesh and the higher the percentage of braid coverage, the more effective the shield is against high-frequency emissions. An alternative is to use more than one braid shield.

Metal Braid is offered in Tubular or Flat configurations in a variety of sizes from 1/32 inch (0.8 mm) to 2½ inches (63.5 mm), and can easily be slipped over convoluted tubing and conduit as well as wire bundles, cables or similar constructions. Glenair's in-house braiding production capacity is truly impressive: More than 50 braiders, ranging from 12 to 96 carriers, provide the capability to produce large quantities of precise metal and non-metallic braid and expandable sleeving in tubular, tapered, and flat configurations.



Happily, there are numerous solutions to electromagnetic noise, and the remainder of this issue of QwikConnect focuses on the many existing and new material types and configurations of EMI/RFI braided shielding (screening) products produced by Glenair that prevent free-standing wire and cable from acting as antennas and carrying unwanted noise into critical electronic gear. Used in conjunction with effective ground-plane designs, conductive box enclosures (or Faraday cages) EMI/RFI braided cable shielding provides the ability for system designers to effectively shield sensitive circuitry from diverse frequencies of EMI.

SERIES 103

AmberStrand[®]

Conductive Composite Braid

The Smart Way to Reduce Launch and Flight Weights in Aerospace Systems

For many applications, the cable shield is the most important element in controlling EMI. Unfortunately, metal shielding—especially when applied in multiple layers—can be extremely heavy. The opportunity to provide robust EMI shielding at a fraction of the weight is the principal advantage of composite thermoset EMI/RFI braid made from AmberStrand[®] material. Transfer impedance test reports demonstrate the effectiveness of the material compared to conventional metal solutions. So get smart! Reduce weight and save money with AmberStrand[®]

- *Reduce Shielding Weight Up To 80% and More*
- *Composite Thermoset Base Material (PBO)*
- *Numerous Military Aerospace OEM Qualifications*
- *Electrically Conductive Surface Plating*
- *Superior High Frequency Shielding in High Temperature Applications*
- *Comparable Shielding Performance to 36 AWG Tubular Copper Braid*
- *Corrosion-Free*

AmberStrand® Composite Braid Weight Saving Analysis Comparison

100% and 75% Metal Clad AmberStrand® Weight vs. Tin-Coated Copper						
Braid Diameter	AmberStrand® 100% 103-026	Nickel Copper 100-003	% Weight Savings/ Foot	AmberStrand® 75/25 NiCu% 103-027	Nickel Copper 100-003	% Weight Savings/Foot
.062	.6	1.9	68%	.9	1.9	52%
.125	1.0	4.8	79%	1.5	4.8	68%
.250	1.8	16.1	88%	2.4	16.1	85%
.375	2.3	18.5	87%	3.9	18.5	79%
.500	3.7	22.3	83%	5.4	22.3	76%
.625	4.4	27.7	84%	6.4	27.7	77%
.750	5.2	34.3	85%	7.2	34.3	79%
1.000	8.0	35.0	77%	11.0	35.0	69%

With weight saving bounties valued at \$1000 a pound and more, AmberStrand® is the smartest and most cost-effective way to reduce aircraft all-up and launch weights. Replacing standard metal braid with AmberStrand® is like buying dollar bills for 50 cents. 100 Feet of 5/8" AmberStrand® Vs. Tinned Copper Shield Saves 5+ Pounds.

100% Metal Clad AmberStrand® Weight vs. Nickel Copper					
Size	Diameter	AmberStrand® Lbs. per cft	36 AWG Cu Lbs. per cft	Lbs. Difference	% Lighter
002	.062	.1322	.40	.2678	67.5%
004	.125	.2205	1.03	.8095	78.6%
008	.250	.3968	3.45	3.053	88.5%
012	.375	.5071	3.95	3.443	87.1%
016	.500	.8175	4.77	3.954	82.9%
020	.625	.9700	5.94	4.970	83.6
024	.750	1.146	7.35	5.154	84.4%
032	1.000	1.7637	7.50	5.736	76.4



SERIES 103

AmberStrand®

Aircraft Utilization Analysis

Comparison of AmberStrand® Composite to 36 AWG A-A-59569 Ni/Cu Braid

Length and Weight of NiCu Braid in Typical Commercial Carrier			
Diameter (in)	Weight (Lb/ft)	Length (in)	Weight (Lb)
0 - 0.25	0.02	12564.8	21.08
0.25 - 0.5	0.05	5259.3	21.17
0.5 - 0.75	0.07	1212.6	7.12
0.75 - 1.0	0.14	1437.4	16.88
1.0 - 1.5	0.18	467	7.05
Total weight			73.30

Weight Savings Using AmberStrand® (Equivalent Lengths)					
Diameter (in)	Weight (Lb/ft)	Length (in)	Weight (Lb)	Diameter (in)	Length in feet
0 - 0.25	0.003	12564.8	4.16	0 - 0.25	1047.07
0.25 - 0.5	0.008	5259.3	3.58	0.25 - 0.5	438.28
0.5 - 0.75	0.011	1212.6	1.16	0.5 - 0.75	101.05
0.75 - 1.0	0.018	1437.4	2.11	0.75 - 1.0	119.78
1.0 - 1.5	0.034	467	1.30	1.0 - 1.5	38.92
Total weight			12.31	Total (feet)	
				1745.09	

Aircraft Zone Typical Braid Utilization (length in inches)								
L Wing	R Wing	Fwd Belly	Aft Belly	HYD Bay	Aft Barrel	Tail	V/H Stab	Totals
1852.2	1852.2	0	2811.4	168.2	2015.2	2480.6	1385	12564.8
434.8	434.8	511.6	1034.6	257.4	506.2	958.2	1121.7	5259.3
0	0	260.9	223	0	184.2	392.4	152.1	1212.6
0	0	77.2	0	0	1198	162.2	0	1437.4
0	0	0	0	0	446	21	0	467

Using AmberStrand® in place of metallic overbraid saves 60+ pounds

AmberStrand® Performance Specifications

Comparison of AmberStrand® Composite to standard braid materials

Amberstrand® Mechanical Performance Compared To Other Materials											
Material Type	AmberStrand® Thermoset	PEEK (Monofil)	Teflon (Yarn)	Kevlar (Yarn)	Dacron (Yarn)	Halar (Monofil)	Teflon FEP (Monofil)	Nomex (Yarn)	Polyester Type FR (Monofil)	Ryton Type R-7 (Monofil)	PTFE-Glass (Yarn)
Glenair P/N	103-026 103-027	102-051	102-061	102-071	102-073	102-023	102-060	103-013	102-001 102-002	102-080	100-022
Temperature Range	-65°C to +200°C	-65°C to +260°C	-55°C to +200°C	-73°C to +175°C	-62°C to +150°C	-65°C to +200°C	-55°C to +260°C	-55°C to +125°C	-55°C to +200°C	-65°C to +200°C	-75°C to +525°C
Tensile Strength (PSI) Yield	590,000	780,000	40,000	400,000	160,000	35,000	14,000	90,000	50,000	19,000	450,000
Elongation Percentage	2.5%	38%	19%	3.6%	12%	15%	50%	25%	20%	35%	5%
Chemical Resistance	Excellent	Excellent	Excellent	Excellent	Good	Excellent	Excellent	Excellent	Good	Excellent	Excellent
Abrasion Resistance	Good	Excellent	Good	Good	Excellent	Excellent	Good	Good	Good	Excellent	Excellent
Specific Gravity	1.45	1.30	2.10	1.44	1.38	1.68	2.17	1.58	1.38	1.25	2.50
Flammability	Will Not Burn	Very Low	Will Not Burn	Will Not Melt	Flammable	Flammable	Very Low	Will Not Melt	Very Low	Very Low	Will Not Burn

Conductively plated composite material delivers EMC shielding from 40dB to 80dB in frequency ranges from 100kHz to 1GHz. Other key performance attributes include:

- **Tensile Strength: 590,000 psi (min)**
- **Ultimate Elongation: 2.5% (min)**
- **Operating Temp: -65°C to 220°C**
- **Thermal Cycling: No Adverse Effects**
- **Flame: Self Extinguishing**
- **Specific Gravity: 1.45% (max)**
- **Flex Test: 50,000 Cycles**
- **Salt Spray: 500 Hours**

Aircraft All-Up Weight (AUW) has Met its Match: ArmorLite Microfilament Stainless Steel Braid Saves Pounds Compared to Standard QQ-B-575/ A-A-59569 EMI/RFI Shielding. Save Weight and Money Every Time You Fly.

SERIES 103

ARMORLITE™

*Shields from 40dB to 80dB
in Frequency Ranges from
30kHz to 2.5GHz*

*Numerous Military
Aerospace OEM
Qualifications*

*High-Temperature Tolerant ArmorLite™
Reduces Weight in Shielded Interconnect Cables*

ArmorLite™ is an expandable, ultra-flexible, high-strength, conductive stainless steel microfilament material designed for use as EMI/RFI shielding in high-performance interconnect cabling. The principal benefit of ArmorLite™ is its extreme lightweight compared to conventional Nickel Copper shielding. By way of comparison, 100 feet of 5/8 inch ArmorLite™ is more than four pounds lighter than standard QQ-B-575/A-A-59569 shielding. Plus, ultra-flexible ArmorLite™ offers superior temperature tolerance compared to lightweight non-metallic braiding such as AmberStrand™.

Lightweight EMI/RFI Microfilament Nickel Clad Stainless Steel Shielding

- Tensile Strength 70,000 psi per ASTM A580
- Operating Temp: -80°C to 260°C
- Thermal Cycling: No Adverse Effects
- Flame: Self Extinguishing
- Flex Test: 50,000 Cycles
- Salt Spray: 500 Hours
- 70+% Lighter than NiCu QQ-B-575/A-A-59569
- Outstanding EMI/RFI Shielding and Conductivity
- Broader Temperature Range: -80°C to +260°C
- Highly Corrosion Resistant
- Superior Flexibility and “Windowing” Resistance: 90-95% Optical Coverage
- Enhanced EMI/RFI Electrical Performance
- The Best Performing Metallic Braid During Lightning Tests (Run to ANSI/EIA-364-75-1997 Waveform 5B)



ArmorLite™ 103-051 Compared to Nickel/Copper 100-003

Dash Number	Braid Diameter	ArmorLite™ 103-051 (Grams)	Tinned Copper 100-003	% Weight Savings per Foot
001	.031	.5	.9	45%
002	.062	1.15	1.8	36%
004	.125	1.5	4.7	68%
008	.250	2.2	15.6	86%
012	.375	2.9	17.9	84%
016	.500	4.4	21.6	80%
020	.625	4.8	26.9	82%
024	.750	5.8	33.3	83%
032	1.000	11.5	34.0	66%
040	1.250	14.0	35.1	60%
048	1.500	17.3	41.5	58%
064	2.000	22.8	59.6	62%

SERIES 103

ARMORLITE™

Aircraft Utilization Analysis

Comparison of ArmorLite® Composite to standard A-A-59569 Ni/Cu Braid

Length and Weight of NiCu Braid in Typical Commercial Carrier			
Diameter (in)	Weight (Lb/ft)	Length (in)	weight (Lb)
0 - 0.25	0.02	12564.8	21.08
0.25 - 0.5	0.05	5259.3	21.17
0.5 - 0.75	0.07	1212.6	7.12
0.75 - 1.0	0.14	1437.4	16.88
1.0 - 1.5	0.18	467	7.05
Total weight			73.3

Weight Savings Using ArmorLite™ (Equivalent Lengths)				
Diameter (in)	Weight (Lb/ft)	Length (in)	Length in feet	weight (Lb)
0 - 0.25	.00507	12564.8	1047.07	5.309
0.25 - 0.5	.0097	5259.3	438.28	4.251
0.5 - 0.75	.0178	1212.6	101.05	1.737
0.75 - 1.0	.0256	1437.4	119.78	3.063
1.0 - 1.5	.0368	467	38.92	1.434
Total weight				15.794

Aircraft Zone Typical Braid Utilization (length in inches)								
L Wing	R Wing	Fwd Belly	Aft Belly	HYD Bay	Aft Barrel	Tail	V/H Stab	Totals
1852.2	1852.2	0	2811.4	168.2	2015.2	2480.6	1385	12564.8
434.8	434.8	511.6	1034.6	257.4	506.2	958.2	1121.7	5259.3
0	0	260.9	223	0	184.2	392.4	152.1	1212.6
0	0	77.2	0	0	1198	162.2	0	1437.4
0	0	0	0	0	446	21	0	467

Using ArmorLite™ in place of standard nickel-copper braid saves 54.6 pounds

AmberStrand® to ArmorLite™ Part Number Cross-Reference

ArmorLite™ EMI/RFI microfilament nickel clad stainless steel braided shielding offers equivalent EMI shielding and conductivity performance with broader temperature resistance compared to all forms of conductive composite thermoset plastic shielding including Glenair AmberStrand.® ArmorLite™ is suitable for use in all advanced performance and weight reduction applications in which AmberStrand might be specified, but in which higher temperature tolerances are required. The table below provides equivalent AmberStrand® and ArmorLite™ part numbers for ease of comparison and for use in costing exercises.

Braid Diameter	100% AmberStrand®	100% ArmorLite™
.062	103-026-002	103-051-002
.125	103-026-004	103-051-004
.250	103-026-008	103-051-008
.375	103-026-012	103-051-012
.500	103-026-016	103-051-016
.625	103-026-020	103-051-020
.750	103-026-024	103-051-024
1.00	103-026-032	103-051-032
1.25	103-026-040	103-051-040
1.50	103-026-048	103-051-048
2.00	103-026-064	103-051-064
Braid Diameter	75-25% Blend AmberStrand®	75-25% Blend ArmorLite™
.062	103-027-002	103-052-002
.125	103-027-004	103-052-004
.250	103-027-008	103-052-008
.375	103-027-012	103-052-012
.500	103-027-016	103-052-016
.625	103-027-020	103-052-020
.750	103-027-024	103-052-024
1.00	103-027-032	103-052-032
1.25	103-027-040	103-052-040
1.50	103-027-048	103-052-048
2.00	103-027-064	103-052-064

Summary of Glenair Transfer Impedance and Shielding Effectiveness Test Procedure

Purpose:

Test and evaluate Glenair Braids for Transfer Impedance and Shielding Effectiveness.

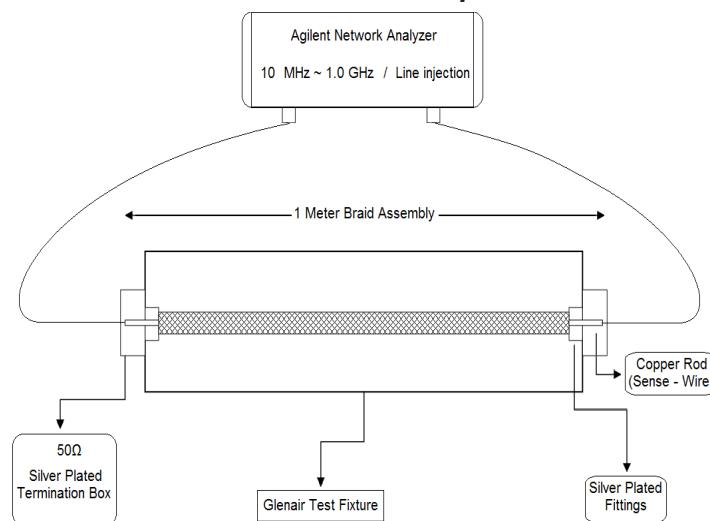

Applicable documents:

The test is performed based on Line injection IEC 96-1 theory, A.5.5.3 Method 2, With modified conditions for the frequency range of 10.0 MHz – 1.0 GHz

Test Setup and calculation:

- Start Frequency: 10.0 MHz
- Stop Frequency: 1.0 GHz
- Sweep Type: Logarithmic Sweep
- Bandwidth (AVG Button): 10Hz
- Sweep Time: Auto
- Power Output: 10 dBm
- Drive Line Measurement
- Sense Line Measurement

$$Z_T = 10^{\left(\frac{S_{21S}(dB) - S_{21D}(dB) + 23.6}{20} \right)}$$

$$\text{Shielding Effectiveness} = 20 \text{ Log } (I_s/I_c) = 20 \text{ Log } ((R_1 + R_2)/Z_T) = 20 \text{ Log } (100/Z_t I)$$

Transfer Impedance and Shielding Effectiveness Tables

For Glenair EMI/RFI Braiding Solutions - 10MHz to 1 GHz Range

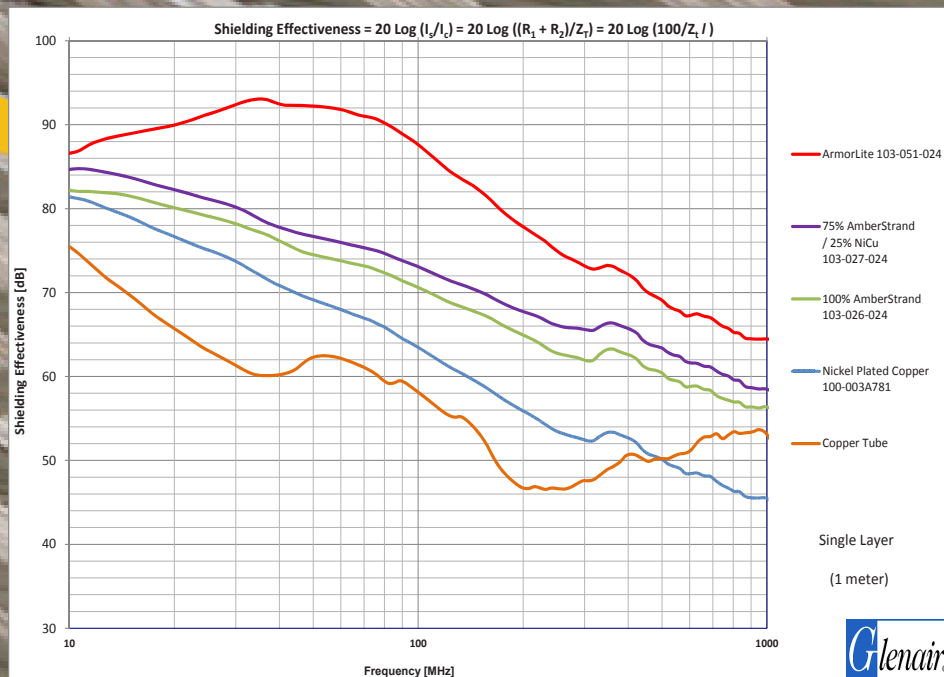
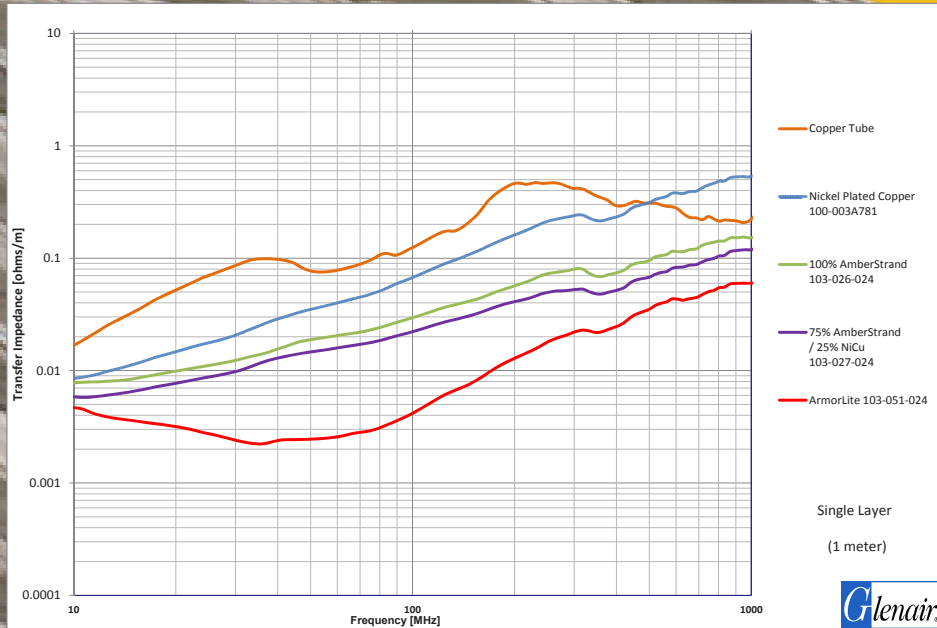

THE BEAUTY OF *Braid* as told through Art

Our publisher has once again challenged us to create a centerfold tribute to our cover story product—but this time with a little more culture and class. We believe this array of fine art from the world's premiere galleries and salons does just that: Each work is a tribute to the art, science, and beauty of braid.

Top row, left to right:
Priestess Isis in Braid, Egypt, Fifth Dynasty, Hieroglyph;
Self Portrait with Braid, Frida Kahlo, 1941, private collection;
Child Braiding a Crown, William-Adolphe Bouguereau, 1874, private collection;
The Braid, Pierre-Auguste Renoir, 1918, private collection;

Middle row, left to right:
Girl Arranging Her Hair, Mary Cassatt, 1886, National Gallery of Art, Washington, D.C.;
Girl With Braids, Amedeo Modigliani, 1918, Nagoya City Art Museum;
Daughter Wilhemina With Her Hair In Braids, Lovis Corinth, 1922, private collection;
Young Girl Braiding Her Hair, Edgar Degas, 1894, private collection;

Bottom row, left to right:
Three Women Combing Their Hair, Edgar Degas, 1875-76, Phillips Collection, Washington, D.C.;
The Hairdressing, Edgar Degas, 1896, National Gallery, London;
Portrait of the Artist's Wife, Allan Ramsay, 1754-1755, National Gallery of Scotland.

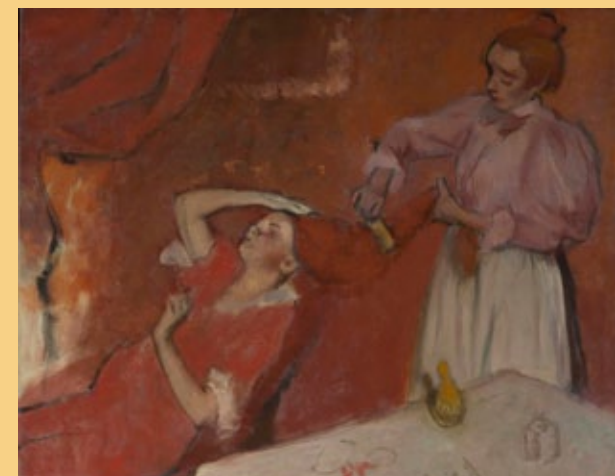
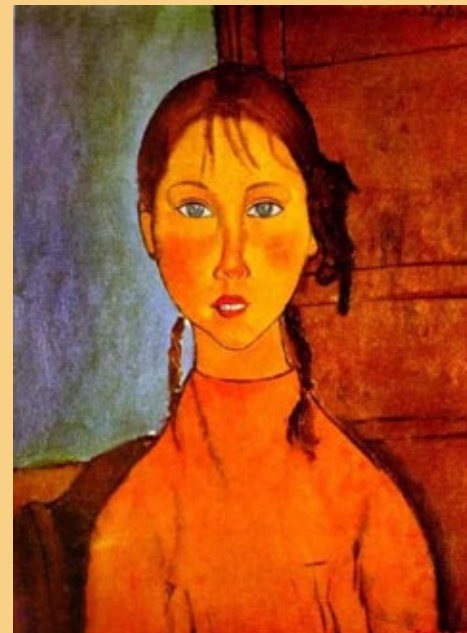

ABOUT THE ARTISTS

William-Adolphe Bouguereau (1825 – 1905) a traditionalist whose realistic genre paintings were modern interpretations of classical subjects.

Mary Stevenson Cassatt (1844 – 1926) American painter and printmaker who befriended Degas and exhibited among the Impressionists.

Lovis Corinth (1858 – 1925) German painter whose work realized a synthesis of impressionism and expressionism.

Edgar Degas (1834 – 1917) French artist famous for his depictions of dancers.

Frida Kahlo de Rivera (1907 – 1954) Mexican painter best known for her self-portraits.

Amedeo Clemente Modigliani (1884 – 1920) Italian artist best known for paintings characterized by mask-like faces and elongation of form.

Allan Ramsay (1713 – 1784) Scottish portrait-painter whose portrait of his brown-eyed second wife Margaret reveals both his true artistry and the influence of French styles on the painter.

Pierre-Auguste Renoir (1841 – 1919) French artist who was a leading painter in the development of the Impressionist style.

Glenair High Performance Metal Clad Micro-Filament EMI/RFI Braided Shielding Test Report Summaries

103-026 AmberStrand® 100% Lightweight Composite Thermoplastic Nickel Plated EMI/RFI Braid

Tensile Strength	590,000 psi (min)	ATP196 MOD
Operating Temperature	-80°C to +220°C	85% shielding effectiveness, 1000 hrs
Specific Gravity	1.45% (max)	ISO 1183
Thermal Cycling	No adverse effects in visual inspection or resistance after 50 cycles	-65°C to +200°C In accordance with ANSI/EIA-364-75-1997
Lightning Current	Glenair qualification test report 040607AMB	In accordance with ANSI/EIA-364-75-1997
Surface Transfer Impedance	Glenair qualification test report 040607AMB	IEC 96.1 A.5.5.3 method 2
Vertical Flammability	Self-extinguishing ≤ 2 sec. Burn length 0.1 in. max - Dripping 0.0 sec	14CFR part 25.853 (A) AMDT25-116 Appendix F Part I (a) (1) (ii)
Fungus Resistance Testing	28 day incubation test: No fungus growth	Mil-Std 810F, Method 508.5
Mass Loss And CVCM	1.0% max mass loss; .10% max CVCM	ASTM E595
Flex Test 50,000 Cycles	No tearing or visible damage	90° to 120° bend
Salt Spray 500 hrs.	DC Resistance IAW AS85049 .5 milliohms; no visible evidence of base metal on braid	ASTM B 117-03 Sodium Chloride 5%
Salt Fog SO ₂	No damage or adverse effects	ASTM G 85 Annex 4 200 hrs.
JP-8 (Mil-T-83133) Military Jet Aircraft Fuel (70°C)	No fraying, DC resistance within limits (AS85049 paragraph 4.6.3)	Mil-Std 810F Method 504 (Modified)
Skydrol Military Jet Aircraft Fuel (90°C)	No fraying, DC resistance within limits (AS85049 paragraph 4.6.3)	Mil-Std 810F Method 504 (Modified)
Hydraulic Fluid Mil-H-5606 (70°C)	No fraying, DC resistance within limits (AS85049 paragraph 4.6.3)	Mil-Std 810F Method 504 (Modified)
Silicate Ester Based Coolanol 25R (70°C)	No fraying, DC resistance within limits (AS85049 paragraph 4.6.3)	Mil-Std 810F Method 504 (Modified)
Polyalphaolefin Mil-C-87252 (70°C)	No fraying, DC resistance within limits (AS85049 paragraph 4.6.3)	Mil-Std 810F Method 504 (Modified)
Lubricating Oil Mil-L-23699 8 hrs. @ 150°C, followed by 72 hrs. @ 65°C	No fraying, DC resistance within limits (AS85049 paragraph 4.6.3)	Mil-Std 810F Method 504 (Modified)
Isopropyl Alcohol 8 hrs. @ 50°C followed by 72 hrs. @ 65°C	No fraying, DC resistance within limits (AS85049 paragraph 4.6.3)	Mil-Std 810F Method 504 (Modified)
Cleaner Fluid Mil-C-85570 8 hrs. @ 23°C followed by 72 hrs. @ 65°C	No fraying, DC resistance within limits (AS85049 paragraph 4.6.3)	Mil-Std 810F Method 504 (Modified)
De-icer Fluid AMS-1432 8 hrs. @ 23°C followed by 72 hrs. @ 65°C	No fraying, DC resistance within limits (AS85049 paragraph 4.6.3)	Mil-Std 810F Method 504 (Modified)
Fire Extinguishing foam 8 hrs. @ 23°C followed by 72 hrs. @ 65°C	No fraying, DC resistance within limits (AS85049 paragraph 4.6.3)	Mil-Std 810F Method 504 (Modified)
R-134 Refrigerant 8 hrs. @ 23°C followed by 72 hrs. @ 65°C	No fraying, DC resistance within limits (AS85049 paragraph 4.6.3)	Mil-Std 810F Method 504 (Modified)

103-051 ArmorLite™ Metal Clad Stainless Steel Microfilament EMI/RFI Braided Shielding

Altitude Test	2.5% (min)	RTCA DO-160F, Table 4-1, Table 4-2 Category C temperature spec
Braid Resistivity Test, Pre and Post	Test pre and post - 5 cycles – minimal disparity per specification	EIA-364-32D IAW AS85049
Surface Transfer Impedance Test, Pre and Post	Glenair ATP -194 Pre - Post. Acceptance IAW AS85049	Line injection (IEC 96-1) A.5.5.3 Method 2
Shielding Effectiveness Test, Pre and Post	Glenair ATP -194 Pre - Post. Acceptance IAW AS85049	Line injection (IEC 96-1) 30KHz - 2.5 GHz
Tensile / Pull Strength Test	Glenair ATP- 183 . No anomalies within 2%-10% of pre test for variable sizes	Glenair ATP 220
Specific Gravity Test	8.2cm ³ (max) per ISO-1183	ASTM A580 (ref:316L Stainless Steel)
Lightning current Test	DC resistance / voltage criteria per DO-160F Level 4 for variable sizes up to 25KA	SAE/ARP54164300-160F sec.22
Vertical Flammability Test	Self-extinguish time, burn length and drip time spec criteria	14 CFR Part 25.853(a) Ammendment 25-116 Appendix F Part I (a) (1) (ii)
Mass Loss and Collected Volatile Condensable Materials Test	TML < 1.00% CVCM < .1%	ASTM E595
Flex Test	Two 180° bend cycles: Total cycles of 25801 and 25930	Glenair ATP 179 IAW AS85049
Salt Spray 500 Hours	No evidence of material or electrical degradation per AS85049	ASTM B117-03 Sodium Chloride 5% 500 hrs.
Salt Fog SO ₂	No damage or adverse effects	ASTM G 85 Annex 4 200 hrs.
Braid Pull Prior to Fluid Immersion Test	No degradation ≤ 90 lbs.	Tensile pull to 90 lbs.
Fluid Immersion Test	No fraying - Visual conformance and length within 2%-10% of pre test.	Customer/SAE AS1241 Table 15 Modified/ MIL-STD 810F Method 504 Modified
Abrasion and Plating Test	20 cycles in opposite directions over 3 arms with .030 radius edges. No broken strands.	Glenair ATP 210 IAW AS85049
MIL-L-23699, Lubricating Aircraft Oil, Synthetic Base. 20 hrs. @ 48°C to 50°C	No fraying, DC resistance within limits (AS85049 paragraph 4.6.3)	SAE AS1241 Table 15 / MIL-STD 810F Method 504 (modified)
MIL-H-5606 Hydraulic Fluid, Petroleum Base. 20 hrs. @ 48°C to 50°C	No fraying, DC resistance within limits (AS85049 paragraph 4.6.3)	SAE AS1241 Table 15 / MIL-STD 810F Method 504 (modified)
TT-I-735, Isopropyl Alcohol. 168 hrs. @ 20°C to 25°C	No fraying, DC resistance within limits (AS85049 paragraph 4.6.3)	SAE AS1241 Table 15 / MIL-STD 810F Method 504 (modified)
D5624 Grade JP-4,-8 or MIL-T-83133 Aviation Fuel. 168 hrs. @ 20°C to 25°C	No fraying, DC resistance within limits (AS85049 paragraph 4.6.3)	SAE AS1241 Table 15 / MIL-STD 810F Method 504 (modified)
SAE AMS1424, Anti-Icing Fluid, diluted and undiluted. 20 hrs. @ 48°C to 50°C	No fraying, DC resistance within limits (AS85049 paragraph 4.6.3)	SAE AS1241 Table 15 / MIL-STD 810F Method 504 (modified)
MIL-C-43616, Cleaning Compound, Aircraft Surface. 20 hrs. @ 48°C to 50°C	No fraying, DC resistance within limits (AS85049 paragraph 4.6.3)	SAE AS1241 Table 15 / MIL-STD 810F Method 504 (modified)
ASTM D 1153, Methyl Isobutyl Ketone. 168 hrs. @ 20°C to 25°C	No fraying, DC resistance within limits (AS85049 paragraph 4.6.3)	SAE AS1241 Table 15 / MIL-STD 810F Method 504 (modified)
SAE AS 1241, Fire Resistant Hydraulic Fluid for Aircraft. 20 hrs. @ 48°C to 50°C	No fraying, DC resistance within limits (AS85049 paragraph 4.6.3)	SAE AS1241 Table 15 / MIL-STD 810F Method 504 (modified)
MIL-L-7808, Lubricating Engine Oil, Synthetic Base. 30 hrs. @ 118°C to 120°C	No fraying, DC resistance within limits (AS85049 paragraph 4.6.3)	SAE AS1241 Table 15 / MIL-STD 810F Method 504 (modified)
MIL-C-87937, Aircraft Cleaning Compound, diluted and undiluted. 20 hrs. @ 63°C to 68°C	No fraying, DC resistance within limits (AS85049 paragraph 4.6.3)	SAE AS1241 Table 15 / MIL-STD 810F Method 504 (modified)
TT-S-735, Standard Test Fluids; Hydrocarbon, Type I, Type II, Type III and Type VII. 168 hrs. @ 20°C to 25°C	No fraying, DC resistance within limits (AS85049 paragraph 4.6.3)	SAE AS1241 Table 15 / MIL-STD 810F Method 504 (modified)
MIL-PRF-87252, Hydrolytically Stable Coolant Fluid. 168 hrs. @ 20°C to 25°C	No fraying, DC resistance within limits (AS85049 paragraph 4.6.3)	SAE AS1241 Table 15 / MIL-STD 810F Method 504 (modified)

INTEGRATED SOLUTIONS

Swing-Arm Shield Sock Backshells

The selection of an appropriate shield termination backshell depends on many factors, including ease of assembly, cost, repairability, shield type and construction, cable diameter and type, cable jacket thickness, weight and corrosion resistance. Often the choice boils down simply to customer preference, although certainly cable construction, i.e., type of shielding and other mechanical factors is the most significant technical consideration.

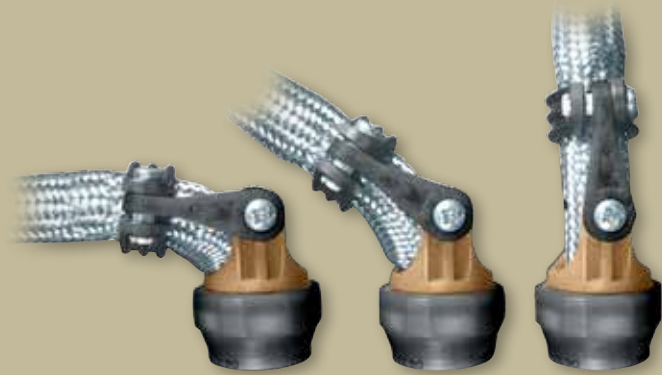

As there is no single shield termination technology or methodology that will meet every customer requirement, Glenair supports every popular shield termination method with the full range of sizes and materials. Currently Glenair is able to produce an innovative backshell product, called the Swing-Arm that resolves

a significant number of design problems—including EMC. The composite thermoplastic Swing-Arm features an integrated EMI shield sock and configurable cable clamp—available with nickel/copper, tinned copper, metal-clad stainless steel or metallized composite thermoplastic shielding. The articulating arm can be configured to straight, 45° or 90° positions, reducing stock keeping requirements. The Swing-Arm also offers extremely fast, simple and trouble-free shield terminations.

Conical Ring Style Backshells

Glenair Series 38 and 39 EMI/RFI conical ring backshells provide reliable individual and overall shield termination by securing the shield under pressure between a conically shaped backshell and ground ring. Supplied in both environmental and non-environmental versions, this venerable backshell design accommodates both individual as well as overall shields and delivers low DC resistance across the termination area.

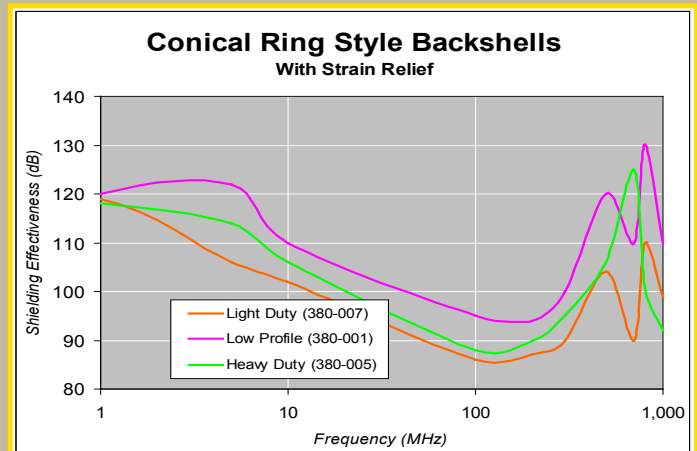
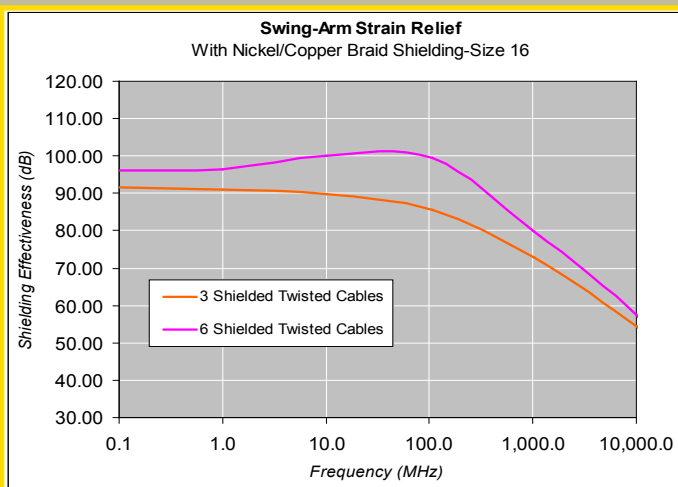

Glenair Band-Master™ ATS

The unique low profile and smooth inside diameter of the Band-Master™ ATS steel clamping band virtually eliminates EMI leakage paths, providing reliable and repairable shield terminations. Cylindrical banding backshells are available for all Military Standard type connectors.

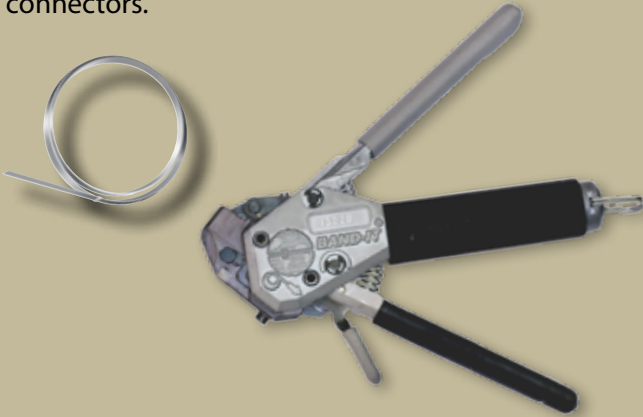

EMI/RFI Elliptical Banding Backshells

EMI Backshells provide shield termination as well as strain relief and mechanical protection. One-piece or split elliptical shells are chosen for rectangular connectors when the wire bundle diameter is too big to fit in a circular cable entry.

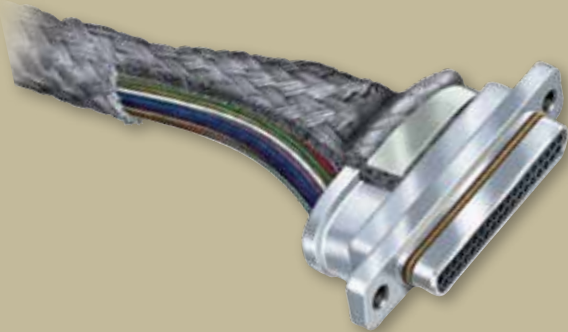

EMI/RFI Braided Ground/Tie-Down Straps

The opportunity to reduce weight and improve the flexibility and performance of grounding jumpers and straps has led many engineers to choose braided material configurations. Braided ground straps are typically supplied with either nickel-clad copper braid, or nickel-clad microfilament stainless steel braid (ArmorLite™). Ground lugs are fabricated from copper nickel plate per MIL-C-26074. The assemblies withstand flexure of 25,000 cycles and are current rated to a minimum of 50 amps. [Ask our braid experts about part number 107-059.](#)

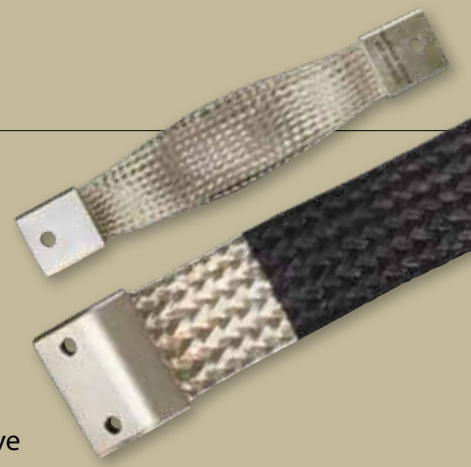

Metal-Core Conduit

Glenair helically-wound metal conduit, overbraided with bronze, stainless steel or tinned copper shielding provides high levels of EMI protection across all radiation fields and frequencies. Metal-Core Conduit is the material of choice for TEMPEST secure communications and other applications involving sensitive electronic equipment and intense levels of EMI.

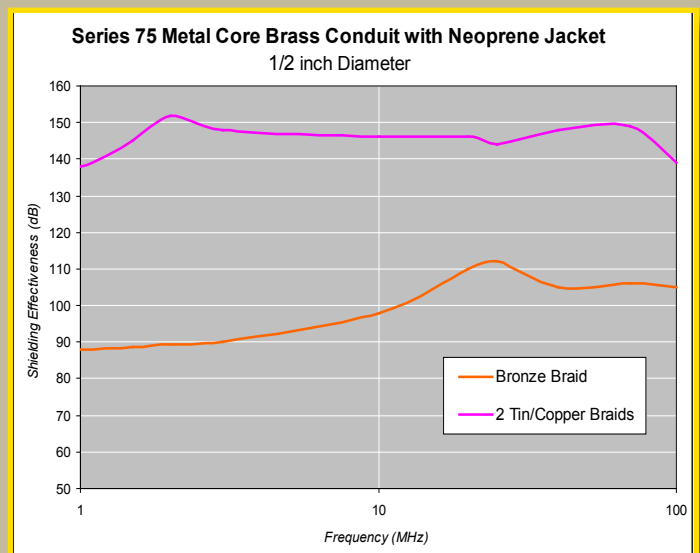
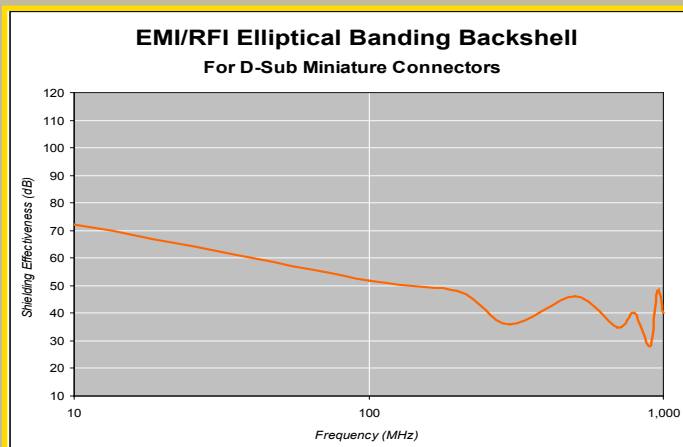

EMI/RFI Braid: How-To-Order

100-001 Tubular Metal Braid QQ-B-575B/A-A-59569 ASTM B298 Tin Coated Copper

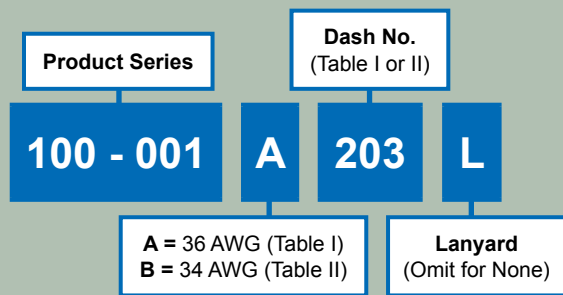
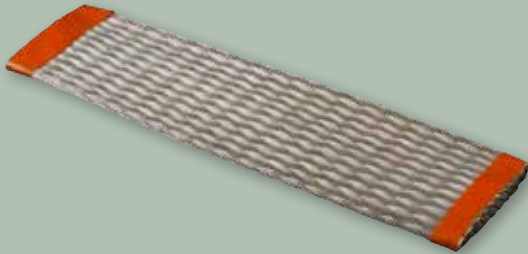

Table I: 36 AWG	
Part No.	I.D. (inches)
100-001 A 031	.031 (0.8)
100-001 A 062	.062 (1.6)
100-001 A 078	.078 (2.0)
100-001 A 109	.109 (2.8)
100-001 A 125	.125 (3.2)
100-001 A 156	.156 (4.0)
100-001 A 171	.171 (4.3)
100-001 A 188	.188 (4.8)
100-001 A 203	.203 (5.2)
100-001 A 250	.250 (6.4)
100-001 A 375	.375 (9.5)
100-001 A 500	.500 (12.7)
100-001 A 625	.625 (15.9)
100-001 A 781	.781 (19.8)
100-001 A 937	.937 (23.8)
100-001 A 1000	1.000 (25.4)
100-001 A 1125	1.125 (28.6)
100-001 A 1250	1.250 (31.8)
100-001 A 1375	1.375 (34.9)
100-001 A 1500	1.500 (38.1)
100-001 A 1562	1.562 (39.7)
100-001 A 2000	2 (50.8)
100-001 A 2300	2.300 (58.4)
100-001 A 2500	2.500 (63.5)
100-001 A 3375	3.375 (85.7)

Table II: 34 AWG	
Part No.	I.D. (inches)
100-001 B 062	.062 (1.6)
100-001 B 109	.109 (2.8)
100-001 B 125	.125 (3.2)
100-001 B 171	.171 (4.3)
100-001 B 203	.206 (5.2)
100-001 B 375	.375 (9.5)
100-001 B 437	.437 (11.1)
100-001 B 500	.500 (12.7)
100-001 B 781	.781 (19.8)
100-001 B 1000	1.000 (25.4)
100-001 B 1250	1.250 (31.8)

100-002 Tubular Metal Braid QQ-B-575B/A-A-59569 ASTM B298 Silver Coated Copper

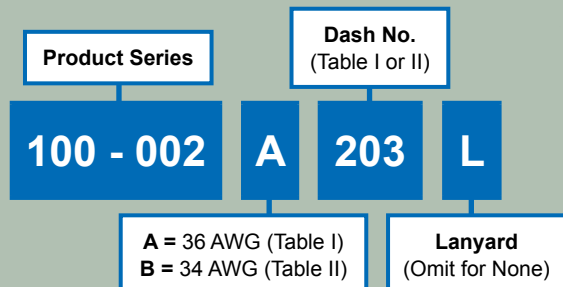

Table I: 36 AWG	
Part No.	I.D. (inches)
100-002 A 031	.031 (0.8)
100-002 A 062	.062 (1.6)
100-002 A 078	.078 (2.0)
100-002 A 109	.109 (2.8)
100-002 A 125	.125 (3.2)
100-002 A 156	.156 (4.0)
100-002 A 171	.171 (4.3)
100-002 A 188	.188 (4.8)
100-002 A 203	.203 (5.2)
100-002 A 250	.250 (6.4)
100-002 A 375	.375 (9.5)
100-002 A 500	.500 (12.7)
100-002 A 625	.625 (15.9)
100-002 A 781	.781 (19.8)
100-002 A 937	.937 (23.8)
100-002 A 1000	1.000 (25.4)
100-002 A 1250	1.125 (28.6)
100-002 A 1375	1.250 (31.8)
100-002 A 1500	1.375 (34.9)
100-002 A 2000	2 (50.8)
100-002 A 2500	2.500 (63.5)

Table II: 34 AWG	
Part No.	I.D. (inches)
100-002 B 062	.062 (1.6)
100-002 B 109	.109 (2.8)
100-002 B 125	.125 (3.2)
100-002 B 171	.171 (4.3)
100-002 B 203	.206 (5.2)
100-002 B 375	.375 (9.5)
100-002 B 437	.437 (11.1)
100-002 B 500	.500 (12.7)
100-002 B 781	.781 (19.8)
100-002 B 1000	1.000 (25.4)
100-002 B 1250	1.250 (31.8)

Minimum order length is 100 ft. (30.5 M). Metric dimensions (mm) are in parentheses.

100-003 Tubular Metal Braid ASTM B355 Class 7 OFHC Nickel Plated Copper

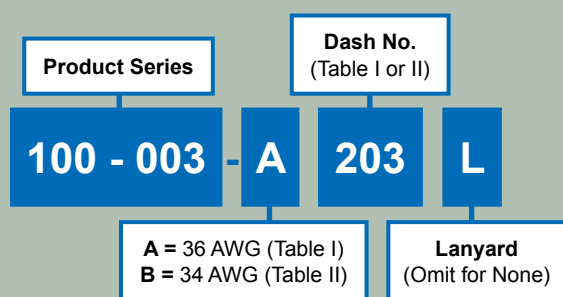
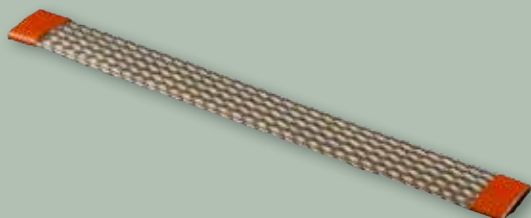

Table I: 36 AWG	
Part No.	I.D. (inches)
100-003 A 031	.031 (0.8)
100-003 A 062	.062 (1.6)
100-003 A 078	.078 (2.0)
100-003 A 109	.109 (2.8)
100-003 A 125	.125 (3.2)
100-003 A 156	.156 (4.0)
100-003 A 171	.171 (4.3)
100-003 A 188	.188 (4.8)
100-003 A 203	.203 (5.2)
100-003 A 250	.250 (6.4)
100-003 A 375	.375 (9.5)
100-003 A 500	.500 (12.7)
100-003 A 562	.562 (14.3)
100-003 A 625	.625 (15.9)
100-003 A 781	.781 (19.8)
100-003 A 937	.937 (23.8)
100-003 A 1000	1.000 (25.4)
100-003 A 1250	1.250 (31.8)
100-003 A 1375	1.375 (34.9)
100-003 A 1500	1.500 (38.1)
100-003 A 2000	2 (50.8)
100-003 A 2500	2.500 (63.5)

Table II: 34 AWG	
Part No.	I.D. (inches)
100-003 B 062	.062 (1.6)
100-003 B 109	.109 (2.8)
100-003 B 125	.125 (3.2)
100-003 B 171	.171 (4.3)
100-003 B 203	.203 (5.2)
100-003 B 375	.375 (9.5)
100-003 B 437	.437 (11.1)
100-003 B 500	.500 (12.7)
100-003 B 781	.781 (19.8)
100-003 B 1000	1.000 (25.4)
100-003 B 1250	1.250 (31.8)
100-003 B 1500	1.500 (38.1)
100-003 B 1750	1.750 (44.5)
100-003 B 2000	2 (50.8)

Minimum order length is 100 ft. (30.5 M). Metric dimensions (mm) are in parentheses.

100-041 Tapered Tubular Metal Braid AmberStrand®, ArmorLite™ Nickel/Copper, Silver/Copper or Tin/Copper

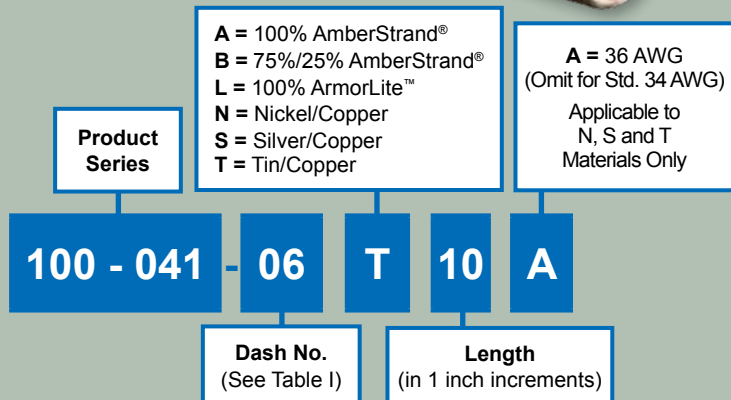
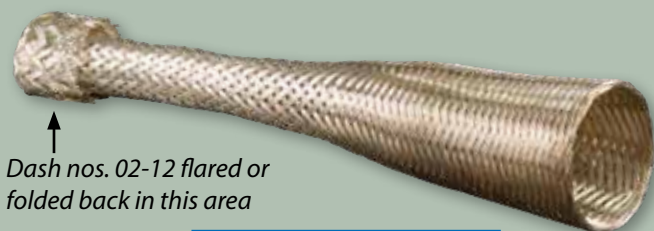

Table I: Part Numbers and Sizes				
Part No.	A (large end dia.)		B (small end dia.)	
	+ .10	(2.5)	+ .10	(2.5)
	- .00	(0.0)	- .00	(0.0)
100-041-01	.30	(7.6)	.15	(3.8)
100-041-02	.45	(11.4)	.30	(7.6)
100-041-03	.60	(15.2)	.30	(7.6)
100-041-04	.75	(19.1)	.30	(7.6)
100-041-05	.75	(19.1)	.50	(12.7)
100-041-06	1.05	(26.7)	.50	(12.7)
100-041-07	1.05	(26.7)	.75	(19.1)
100-041-08	1.20	(30.5)	.75	(19.1)
100-041-09	1.20	(30.5)	1.00	(25.4)
100-041-10	1.50	(38.1)	.75	(19.1)
100-041-11	1.50	(38.1)	1.00	(25.4)
100-041-12	1.50	(38.1)	1.20	(30.5)
100-041-13	.88	(22.4)	.50	(12.7)
100-041-14	1.38	(35.1)	.75	(19.1)

Length: 5.0 (127.0) Minimum, 12.0 (304.8) Maximum. Metric dimensions (mm) are in parentheses.

EMI/RFI Braid: How-To-Order

**103-026 and -027 AmberStrand® EMI/RFI
Microfilament Composite Braided Shielding
100% Composite and 75%/25% Blended Versions**

AmberStrand®



100% AmberStrand®

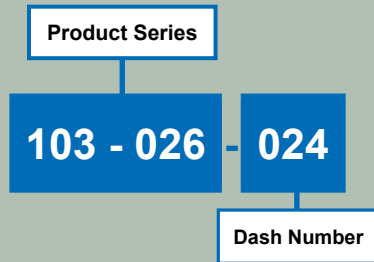

103-026 100% Composite AmberStrand®			
Part No.	Inner Diameter	Ref. Wire Bundle Range	Approximate Grams Per Foot
103-026-004	.125 (3.2)	.093 (2.4)	1.0
		.140 (3.5)	
103-026-008	.250 (6.4)	.125 (3.2)	1.8
		.312 (7.9)	
103-026-012	.375 (9.5)	.325 (8.2)	2.3
		.437 (11.1)	
103-026-016	.500 (12.7)	.375 (9.5)	3.7
		.560 (14.2)	
103-026-020	.625 (15.9)	.375 (9.5)	4.4
		.700 (17.8)	
103-026-024	.750 (19.1)	.500 (12.7)	5.2
		.830 (21.1)	
103-026-032	1.000 (25.4)	.780 (19.8)	8.0
		1.100 (27.94)	
103-026-040	1.250 (31.8)	.938 (23.8)	10.0
		1.312 (33.3)	
103-026-048	1.500 (38.1)	1.187 (30.1)	15.2
		1.590 (40.37)	
103-026-064	2.000 (50.8)	1.312 (33.3)	22.0
		2.090 (53.08)	

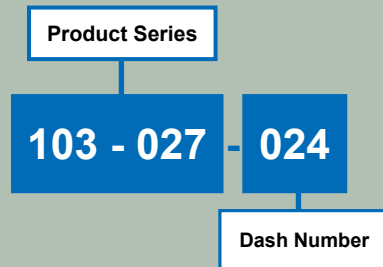

75%/25% AmberStrand®/
Nickel Copper

103-027 75%/25% Blended Composite AmberStrand®/Nickel Copper			
Part No.	Inner Diameter	Ref. Wire Bundle Range	Approximate Grams Per Foot
103-027-004	.125 (3.2)	.093 (2.4)	1.5
		.140 (3.5)	
103-027-008	.250 (6.4)	.125 (3.2)	2.4
		.312 (7.9)	
103-027-012	.375 (9.5)	.250 (6.4)	3.9
		.437 (11.1)	
103-027-016	.500 (12.7)	.375 (9.5)	6.0
		.550 (13.9)	
103-027-020	.625 (15.9)	.375 (9.5)	6.4
		.700 (17.8)	
103-027-024	.750 (19.1)	.500 (12.7)	7.2
		.830 (21.1)	
103-027-032	1.000 (25.4)	.780 (19.8)	11.0
		1.100 (27.94)	
103-027-040	1.250 (31.8)	.938 (23.8)	15.0
		1.312 (33.3)	
103-027-048	1.500 (38.1)	1.187 (30.1)	25.2
		1.590 (40.37)	
103-027-064	2.000 (50.8)	1.312 (33.3)	32.0
		2.090 (53.08)	

Specify length on purchase order. No minimums! Metric dimensions (mm) are in parentheses.

Additional sizes and configurations- consult factory

**103-051 ArmorLite™ Lightweight EMI/RFI
Microfilament Stainless Steel Braided Shielding**



100% ArmorLite™

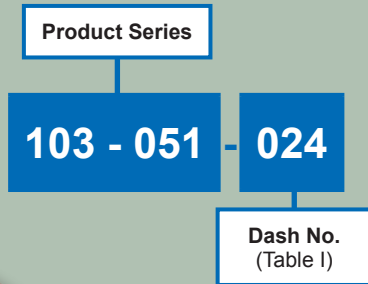
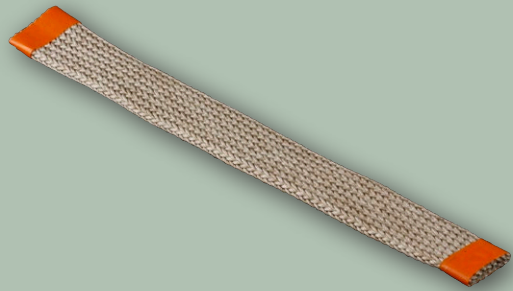

Table I			
Part Number	Inner Diameter	Ref. Wire Bundle Range	Approximate Grams Per Foot
103-051-001	.031 (0.8)	.016 (0.4)	.5
		.047 (1.2)	
103-051-002	.062 (1.6)	.040 (1.0)	1.15
		.075 (1.9)	
103-051-004	.125 (3.2)	.093 (2.4)	1.5
		.140 (3.5)	
103-051-008	.250 (6.4)	.125 (3.2)	2.2
		.312 (7.9)	
103-051-012	.375 (9.5)	.250 (6.4)	2.9
		.406 (10.3)	
103-051-016	.500 (12.7)	.375 (9.5)	4.4
		.560 (14.2)	
103-051-020	.625 (15.9)	.375 (9.5)	4.8
		.700 (17.8)	
103-051-024	.750 (19.1)	.500 (12.7)	5.8
		.800 (20.3)	
103-051-032	1.000 (25.4)	.780 (19.8)	11.5
		1.100 (27.9)	
103-051-040	1.250 (31.8)	.938 (23.8)	14.0
		1.312 (33.3)	
103-051-048	1.500 (38.1)	1.187 (30.1)	17.3
		1.590 (40.4)	
103-051-064	2.000 (50.8)	1.312 (33.3)	22.8
		2.090 (53.1)	

Non-Metallic Braid: How-To-Order **QwikConnect**

100-022 PTFE-Glass Tubular Braided Sleeving



Part No.	Nominal I.D.
100-022-004	1.25 (3.2)
100-022-005	1.56 (4.0)
100-022-006	1.88 (4.7)
100-022-008	.250 (6.4)
100-022-012	.375 (9.5)
100-022-016	.500 (12.7)
100-022-020	.625 (15.9)
100-022-024	.750 (19.1)
100-022-032	1.000 (25.4)
100-022-040	1.250 (31.8)
100-022-048	1.500 (38.1)

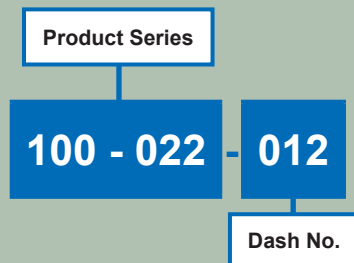

102-001 and -002 Polyethylene Expandable Fabric Tubular Braided Sleeving

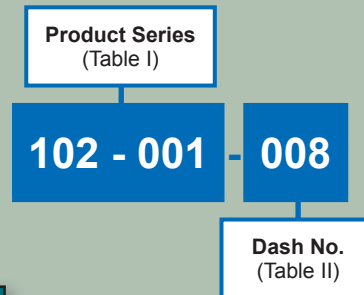
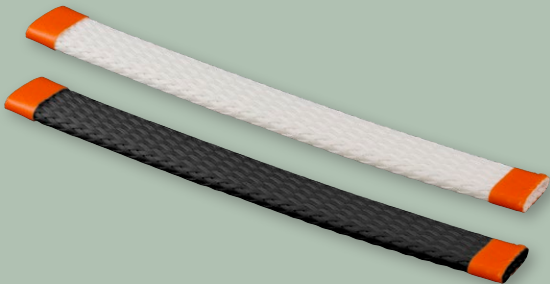

Product Series	Color	Material	Material Dia.	Wall Thickness Nominal	Temperature Range
102-001	White	Polyethylene Terephthalate	.010 (0.25)	.025 (0.6)	-65°F [-54°C] to +250°F [+121°C]
102-002	Black				

Dash No.	Ø Nom.	Ø A (before expansion) Min	Ø B (after expansion) Max	Spec Max Weight in Lbs. Per 100 feet [Kg/30.5 M]
-004	.125 (3.2)	.090 (0.25)	.250 (6.4)	.17 (0.08)
-008	.250 (6.4)	.125 (0.25)	.375 (9.5)	.26 (0.12)
-016	.500 (12.7)	.250 (6.4)	.750 (19.1)	.78 (0.35)
-024	.750 (19.1)	.500 (12.7)	1.250 (31.8)	1.20 (0.54)
-040	1.250 (31.8)	.750 (19.1)	1.500 (38.1)	1.60 (0.73)

Consult factory for sizes not shown

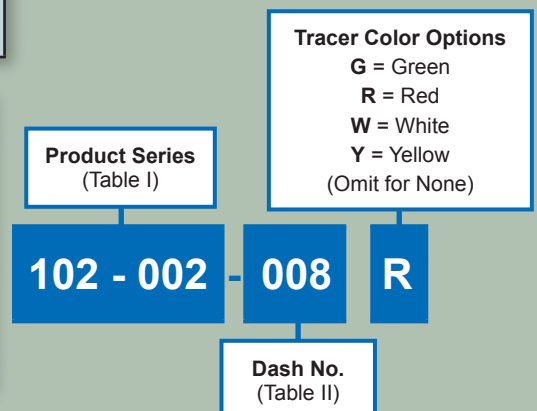

Minimum order length is 100 ft. (30.5 M). Metric dimensions (mm) are in parentheses.

102-020, -021, -022 and -023 Halar Expandable Fabric Tubular Braided Sleeving



Table I				
Product Series	Color	Material Dia.	Wall Thickness Nominal	Temperature Range
102-020	White with Black Tracer	.011 (0.28)	.030 (0.8)	-100°F [-73°C] to +302°F [+150°C]
102-021	Black			
102-022	Black with White Tracer			
102-023	White			

Product Series
(Table I)

102 - 021 - 008

Dash No.
(Table II)

Table II				
Dash No.	Ø Nom.	Ø A (before expansion) Min	Ø B (after expansion) Max	Spec Max Weight in Lbs. Per 100 feet [Kg/30.5]
-004	.125 (3.2)	.090 (0.25)	.250 (6.4)	.29 (0.13)
-008	.250 (6.4)	.125 (0.25)	.375 (9.5)	.39 (0.18)
-016	.500 (12.7)	.250 (6.4)	.750 (19.1)	1.17 (0.53)
-024	.750 (19.1)	.500 (12.7)	1.250 (31.8)	1.81 (0.82)
-040	1.250 (31.8)	.750 (19.1)	1.500 (38.1)	2.56 (1.16)

Consult factory for sizes not shown

Add mod code -645 to the end of any
102-001, 102-002, 102-020, 102-021, 102-022, 102-003 part number for split braid

102-073 Dacron Tubular Braid (Black)

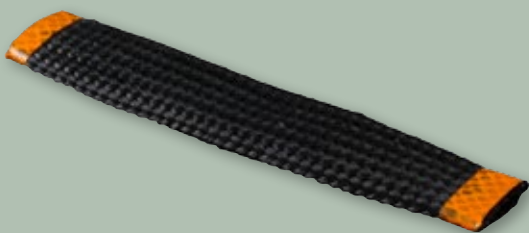

Product Series
(Table I)

102 - 073 - 008

Dash No.
(Table I)

Part No.	Nominal I.D.	Wire Bundle Accomodation Range Ref.	
		Min.	Max.
102-073-004	.125 (3.2)	.090 (2.3)	.250 (6.4)
102-073-008	.250 (6.4)	.125 (3.2)	.375 (9.5)
102-073-012	.375 (9.5)	.312 (7.9)	.500 (12.7)
102-073-016	.500 (12.7)	.250 (6.4)	.750 (19.1)
102-073-024	.750 (19.1)	.500 (12.7)	1.250 (31.8)
102-073-040	1.250 (31.8)	.750 (19.1)	1.500 (38.1)

Non-Metallic Braid: How-To-Order **QwikConnect**

103-013 Nomex Tubular Braid



Color:
W = White
R = Red
GN = Green
GY = Grey
TN = Desert Tan
OR = Orange
(Omit for Black)

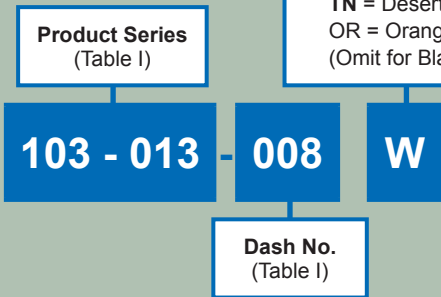

Table I			
Part No.	Nominal I.D.	Wire Bundle Accomodation Range Ref.	
		Min.	Max.
103-013-004	.125 (3.2)	.090 (2.3)	.160 (4.1)
103-013-008	.250 (6.4)	.125 (3.2)	.312 (7.9)
103-013-012	.375 (9.5)	.250 (6.4)	.450 (11.4)
103-013-016	.500 (12.7)	.312 (7.9)	.625 (15.9)
103-013-024	.750 (19.1)	.500 (12.7)	.900 (22.9)
103-013-040	1.250 (31.8)	.750 (19.1)	1.390 (35.3)

102-051 PEEK Tubular Braid (Black)

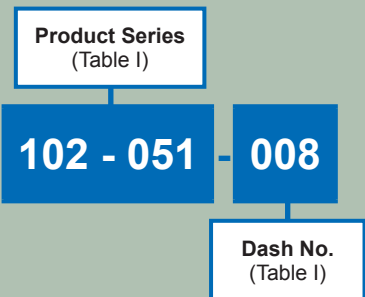
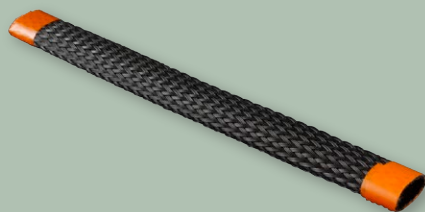

Table I			
Part No.	Nominal I.D.	Wire Bundle Accommodation Range Ref.	
		Min.	Max.
102-051-004	.125 (3.2)	.125 (3.2)	.312 (7.9)
102-051-008	.250 (6.4)	.250 (6.4)	.500 (12.7)
102-051-016	.500 (12.7)	.375 (9.5)	.719 (18.3)
102-051-024	.750 (19.1)	.500 (12.7)	1.000 (25.4)
102-051-040	1.250 (31.8)	.750 (19.1)	1.250 (31.8)

Minimum order length is 100 ft. (30.5 M). Metric dimensions (mm) are in parentheses.

102-061 Teflon Tubular Braid

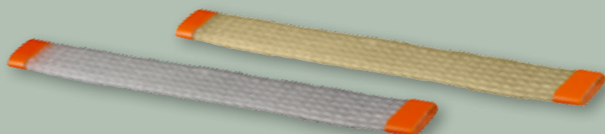
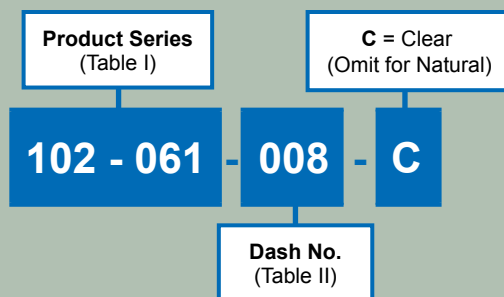

Table II			
Dash No.	Nominal I.D.	Wire Bundle Accommodation Range Ref.	
		Min.	Max.
102-061-004	.125 (3.2)	.090 (2.3)	.250 (6.4)
102-061-008	.250 (6.4)	.125 (3.2)	.375 (9.5)
102-061-016	.500 (12.7)	.250 (6.4)	.750 (19.1)
102-061-024	.750 (19.1)	.500 (12.7)	1.250 (31.8)
102-061-040	1.250 (31.8)	.750 (19.1)	1.500 (38.1)



102-071 Kevlar Tubular Braid (Natural)



Table I			
Part No.	Nominal I.D.	Wire Bundle Accommodation Range Ref.	
		Min.	Max.
102-071-004	.125 (3.2)	.090 (2.3)	.250 (6.4)
102-071-008	.250 (6.4)	.125 (3.2)	.375 (9.5)
102-071-012	.375 (9.5)	.312 (7.9)	.500 (12.7)
102-071-016	.500 (12.7)	.250 (6.4)	.750 (19.1)
102-071-024	.750 (19.1)	.500 (12.7)	1.250 (31.8)
102-071-040	1.250 (31.8)	.750 (19.1)	1.500 (38.1)

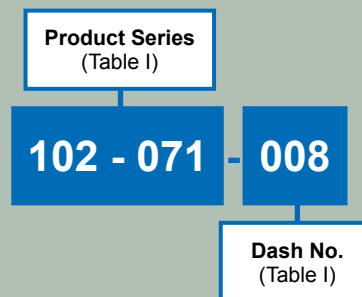

102-072 Nylon Tubular Braid (Black)

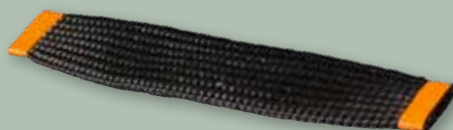
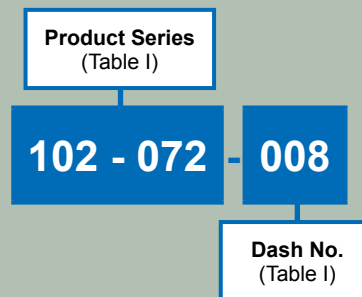

Table I			
Part No.	Nominal I.D.	Wire Bundle Accommodation Range Ref.	
		Min.	Max.
102-072-004	.125 (3.2)	.090 (2.3)	.250 (6.4)
102-072-008	.250 (6.4)	.125 (3.2)	.375 (9.5)
102-072-012	.375 (9.5)	.312 (7.9)	.500 (12.7)
102-072-016	.500 (12.7)	.250 (6.4)	.750 (19.1)
102-072-024	.750 (19.1)	.500 (12.7)	1.250 (31.8)
102-072-040	1.250 (31.8)	.750 (19.1)	1.500 (38.1)



Minimum order length is 100 ft. (30.5 M). Metric dimensions (mm) are in parentheses.

Suggested Assembly Procedure for Harness Breakouts Utilizing EMI/RFI Tubular Braid

Materials:

- Appropriately sized Tubular Braid Material
- Split Rings P/N 687-749
- Band-Master™ ATS Banding Straps P/N 600-052
- Band-Master™ ATS Banding Tool P/N 600-058
- Tape (for wrapping bundles)
- Lace tie

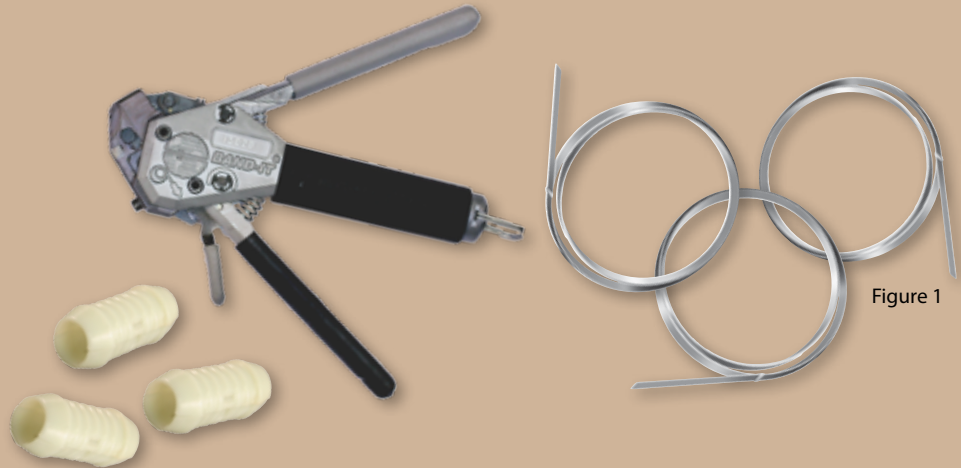

Figure 1

Step 1 Tape and spot tie junction areas as depicted in photo.



Step 2 Install lengths of braid over the breakout legs. Slide braid onto main leg. Flare the braid material out and over the main leg of the assembly and breakouts. Spot tie main leg braid in place.



Step 3 Place split ring onto main leg – extend the braid over the ring, tie, trim, and tape.

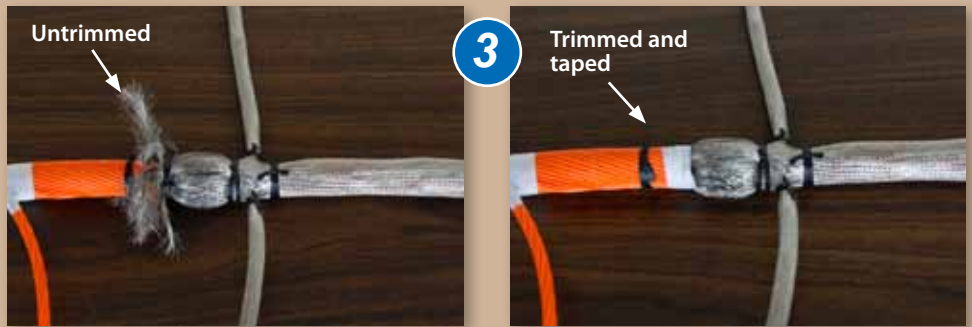

Step 4 Take a separate braid and fish mouth one end. Install fish mouthed end over the main leg and two breakouts onto the split ring. Overlap both pieces to surround the breakout leg and totally cover the split ring.

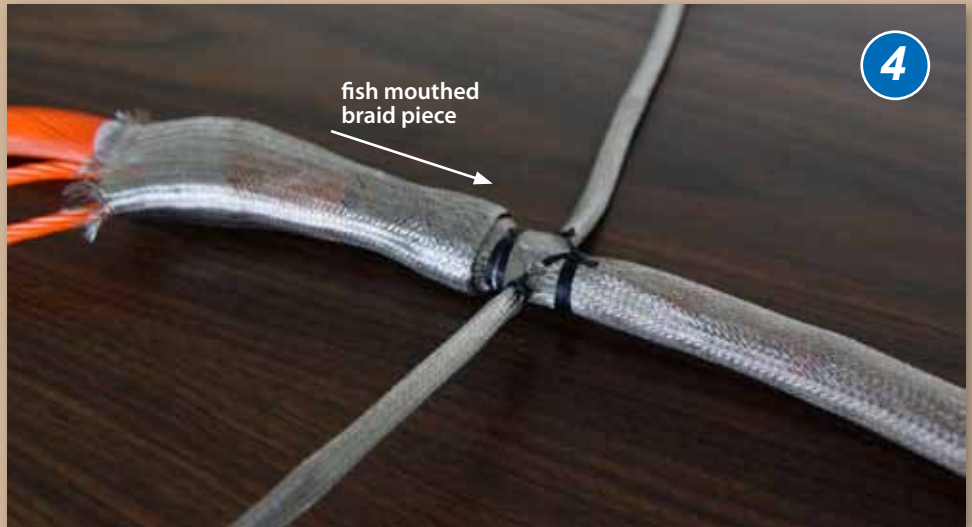

Step 5 Install a Glenair Band-Master ATS™ Band over each termination area, centered on split support rings.

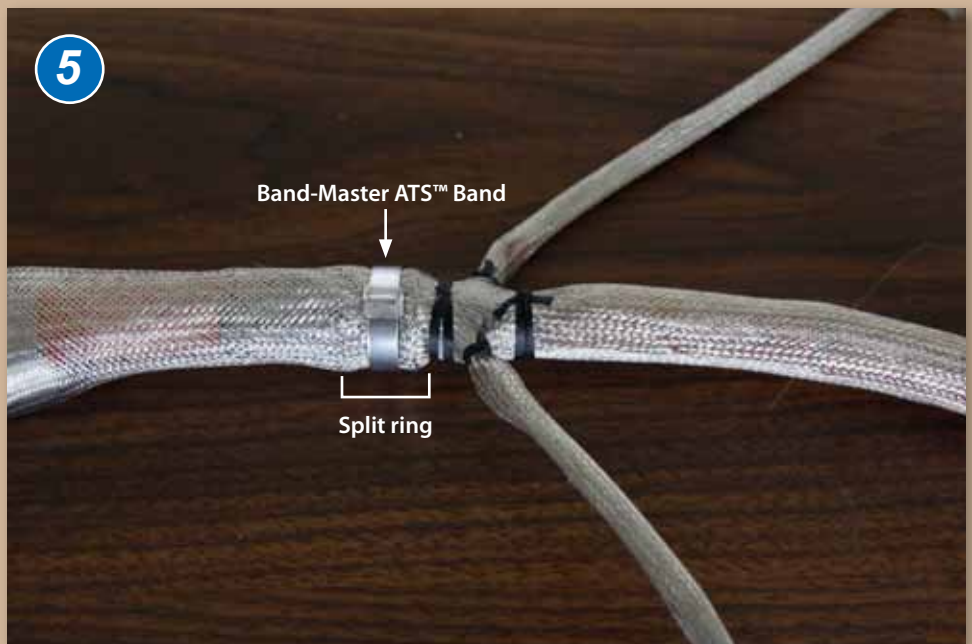

Step 6 Slide two separate lengths of braid over the other breakout legs, flare braid out at the main leg on both breakouts.

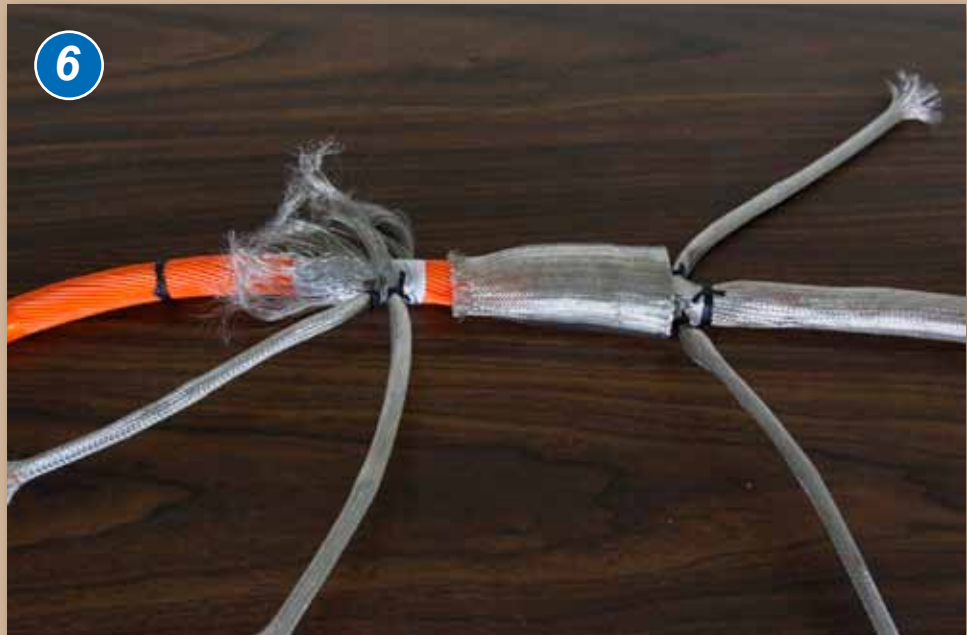

IMPORTANT: Always roll band through the buckle slot twice (see coiled band Figure 1). Bands must be double-coiled to function correctly. The failure to roll the band through the buckle slot twice is the most common user error in band style terminations.

Step 7 Flare out the main transition leg braid. Pull until braid is tight at second breakout and spot tie.



Step 8 Install split ring on main trunk under the flared area. Pull all braids over the split ring. Spot tie, trim, and tape at the end of the split ring.

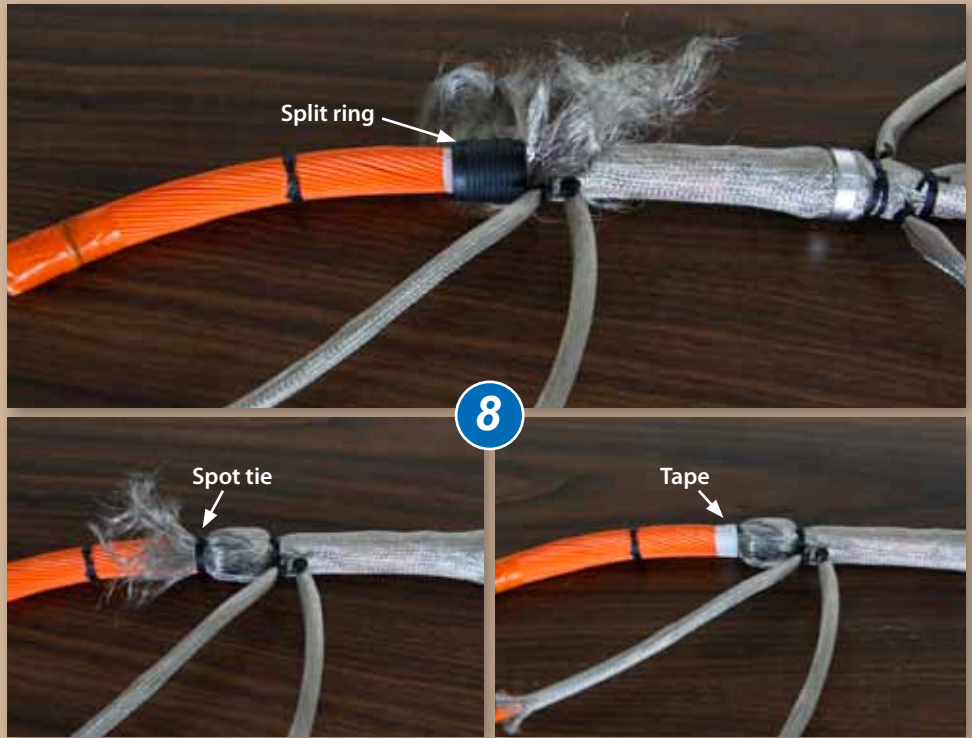

Step 9 Install the final piece of braid over the main leg with fish mouth end on the split ring. Band in place as above.

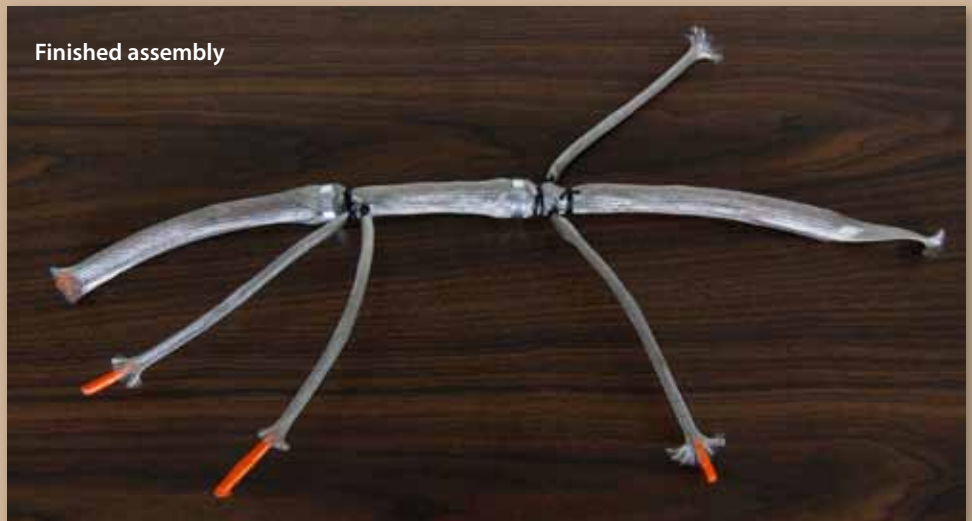
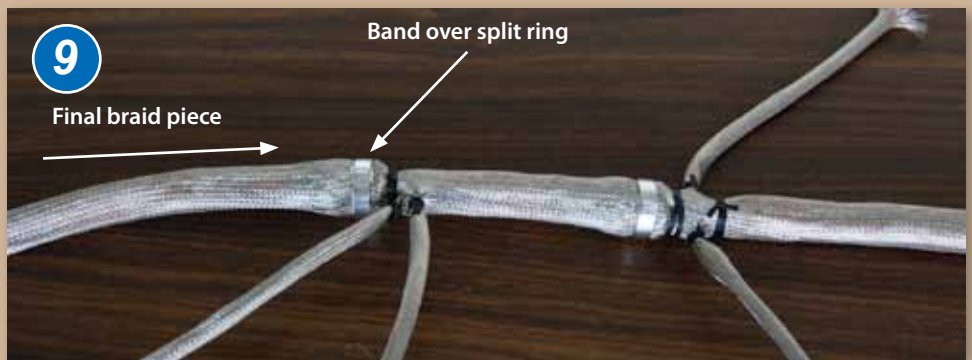

You Got a Problem?

I'd like to begin my column with a question: *what exactly is the nature of our business?* Or, to put it another way, *what exactly do we sell?* Yes, this is a trick question, and the answer is not just "connectors, cables and accessories." It is a little more complicated than that. I would like to propose that what we sell is solutions to problems—problems such as electromagnetic compatibility in interconnect systems, or weight reduction in aerospace applications, or environmental sealing of sensitive electrical or photonic circuits. One of the Glenair founders, Marv Borden, describes this focus on customer problems (rather than just products) as solutions that "do a job."

Here is a good example (from outside our industry) of what we're talking about: The Baldwin Locomotive Works was a giant of American industry and one of just two or three successful locomotive manufacturers servicing a booming American rail market throughout the 20th century. Baldwin was, first and foremost, a steam engine manufacturer. When newer diesel technologies began to gain popularity, Baldwin made the mistake of arrogantly standing pat with its core technology, believing there would always be a market for steam locos. When improvements and advances in diesel motors, such as reduced maintenance costs and complexity, rendered steam solutions increasingly less popular, Baldwin found itself woefully unprepared to compete in the diesel market. Ultimately, the company had to close its doors.

So what was the exact nature of Baldwin's business? Unfortunately, their management team believed it was building and selling steam locomotives. In fact, their business would probably have been more correctly described as "servicing rail industry motive power requirements" (regardless of the fuel or power-generation model). I doubt Baldwin's customers would have described their "problem" as the need to buy a particular flavor of locomotive engine, but rather the need to efficiently and reliably move rail cars from point A to point B (regardless of the technology involved). Baldwin failed because the products they built had more to do with their own interests and capabilities than with the real problems their customers were trying to solve in a dynamic world and marketplace.

The lesson here is that we should always strive to combine our high-service model with a sincere willingness to understand the real problems our customers are trying to solve. When we do so, we put ourselves in the best position possible to, as Mr. Borden would say, "do a job" for our customers.

Chris Toomey

Publisher

Christopher J. Toomey

Executive Editor

Marcus Kaufman

Managing Editor

Carl Foote

Editor

Mike Borgsdorf

Art Director

Charles W. Belser

Technical Consultant

Jim Donaldson

Issue Contributors

Bert Bergsrud

Ken Cerniak

Jim Darling

Israel Fragoso

Ralph Hays

Pat McGee

Dave Tonkiss

Mike Wofford

Distribution

Terry White

QwikConnect is published quarterly by Glenair, Inc. and printed in the U.S.A. All rights reserved. © Copyright 2011 Glenair, Inc. A complete archive of past issues of QwikConnect is available on the Internet at www.glenair.com/qwikconnect

GLENAIR, INC.

1211 AIR WAY
 GLENDALE, CA 91201-2497
 TEL: 818-247-6000
 FAX: 818-500-9912
 E-MAIL: sales@glenair.com
www.glenair.com

