

GaAs SMT pHEMT LOW NOISE AMPLIFIER, 7 - 14 GHz



Typical Applications

The HMC564LC4 is ideal for use as a LNA or driver amplifier for:

- Point-to-Point Radios
- Point-to-Multi-Point Radios & VSAT
- Test Equipment and Sensors
- Military & Space

Features

- Noise Figure: 1.8 dB
- Gain: 17 dB
- OIP3: 25 dBm
- Single Supply: +3V @ 51 mA
- 50 Ohm Matched Input/Output
- RoHS Compliant 4 x 4 mm Package

Functional Diagram

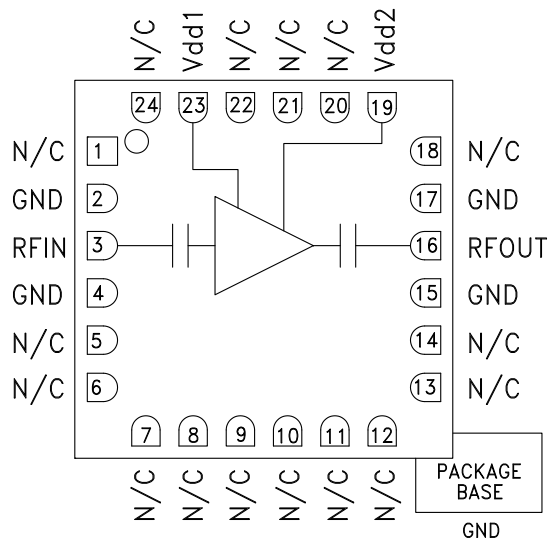

General Description

The HMC564LC4 is a high dynamic range GaAs pHEMT MMIC Low Noise Amplifier housed in a leadless RoHS compliant 4x4 mm SMT package. Operating from 7 to 14 GHz, the HMC564LC4 features extremely flat small signal gain of 17 dB as well as 1.8 dB noise figure and +25 dBm output IP3 across the operating band. This self-biased LNA is ideal for microwave radios due to its consistent output power, single +3V supply operation, and DC blocked RF I/O's.

Electrical Specifications, $T_A = +25^\circ\text{C}$, $V_{dd\ 1, 2} = +3V$

Parameter	Min.	Typ.	Max.	Units
Frequency Range	7 - 14			GHz
Gain	14	17		dB
Gain Variation Over Temperature		0.02	0.03	dB/ °C
Noise Figure		1.8	2.2	dB
Input Return Loss		15		dB
Output Return Loss		14		dB
Output Power for 1 dB Compression (P1dB)	10	13		dBm
Saturated Output Power (P _{sat})		14.5		dBm
Output Third Order Intercept (IP3)		25		dBm
Supply Current (I _{dd})(V _{dd} = +3V)		51	75	mA



GaAs SMT pHEMT LOW NOISE AMPLIFIER, 7 - 14 GHz

Broadband Gain & Return Loss

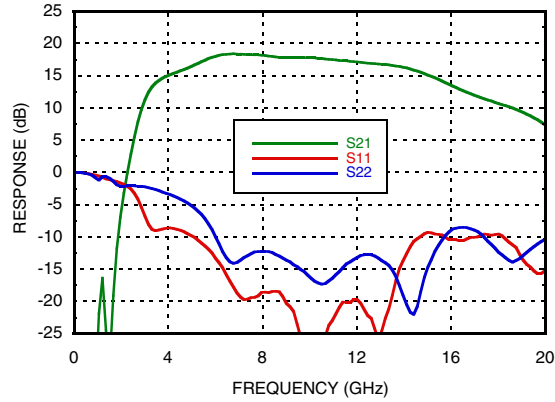

Gain vs. Temperature

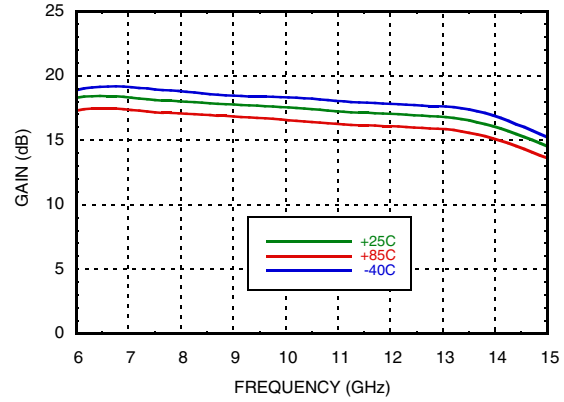

Input Return Loss vs. Temperature

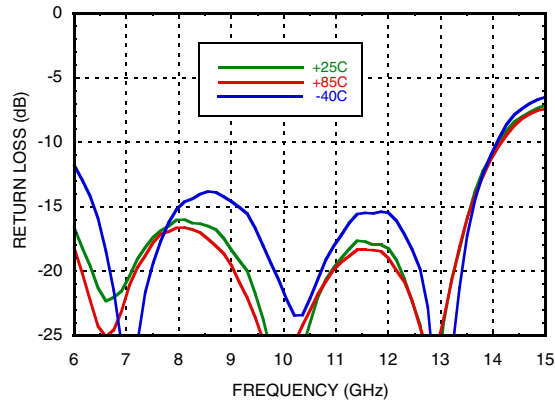

Output Return Loss vs. Temperature

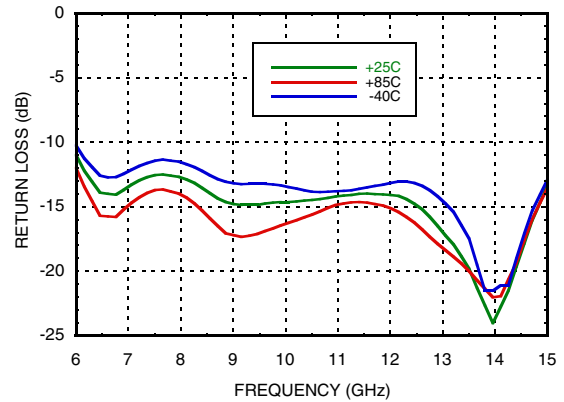

Noise Figure vs. Temperature

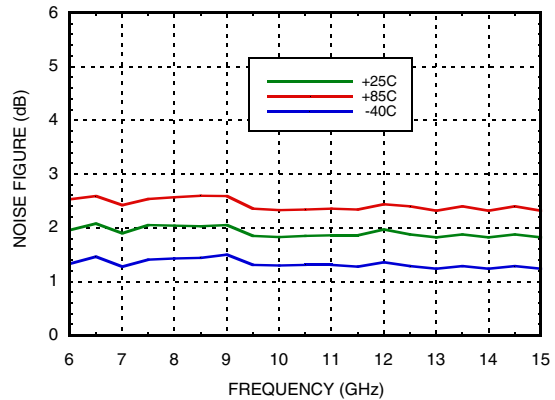

Output IP3 vs. Temperature

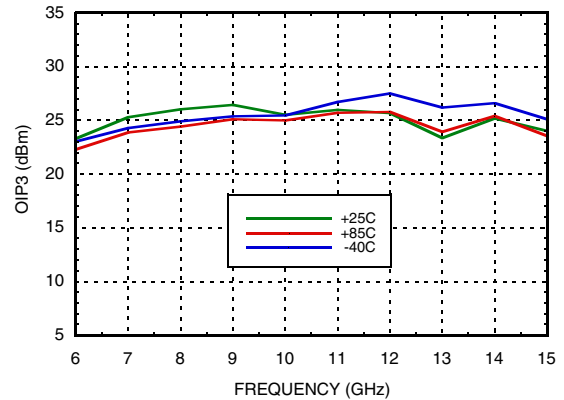



GaAs SMT pHEMT LOW NOISE AMPLIFIER, 7 - 14 GHz

P1dB vs. Temperature

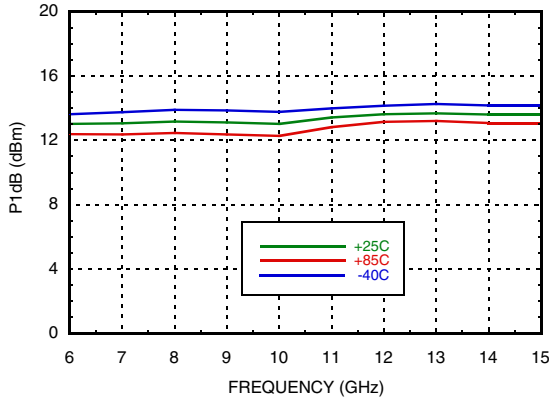

Psat vs. Temperature

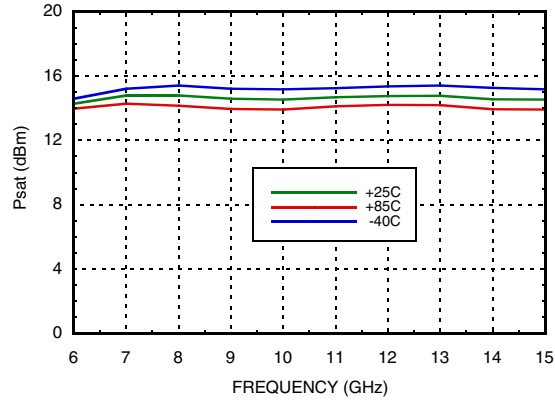

Reverse Isolation vs. Temperature

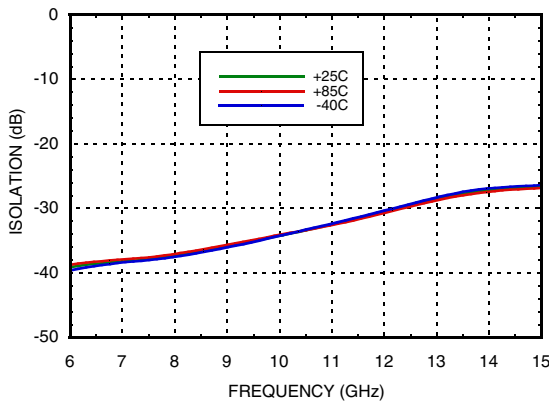

Power Compression @ 8 GHz

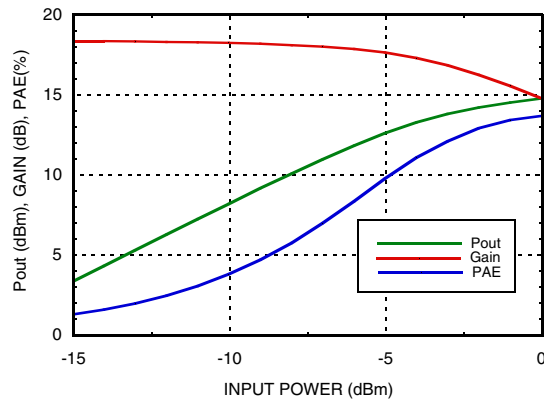

Gain, Power & Noise Figure vs. Supply Voltage @ 8 GHz

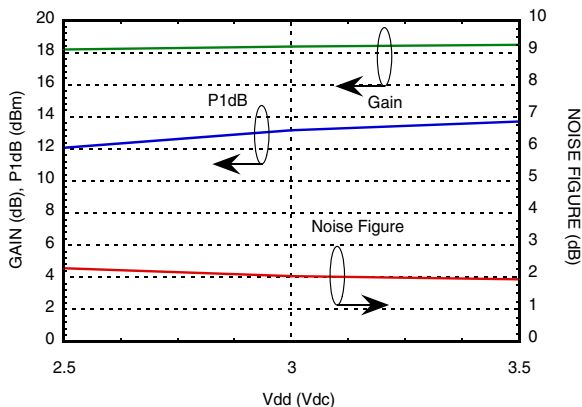

Additive Phase Noise Vs Offset Frequency, RF Frequency = 11 GHz, RF Input Power = 2.5 dBm (Psat)

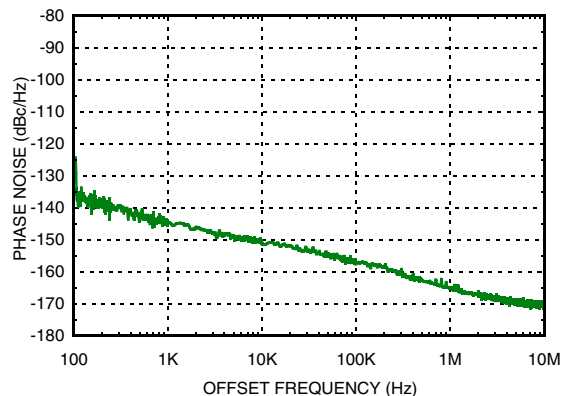



**GaAs SMT pHEMT LOW NOISE
AMPLIFIER, 7 - 14 GHz**

**Additive Phase Noise Vs Offset Frequency,
RF Frequency = 11 GHz,
RF Input Power = -4 dBm (P1dB)**

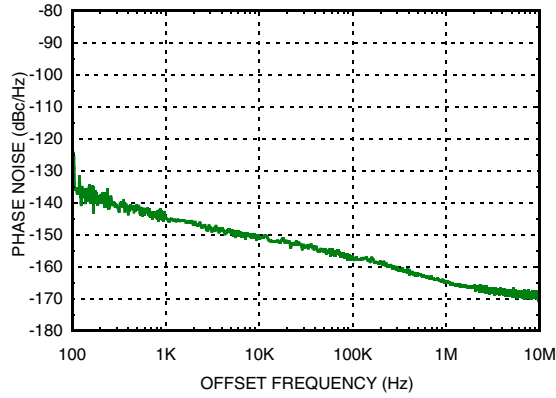

Notes:



GaAs SMT pHEMT LOW NOISE AMPLIFIER, 7 - 14 GHz

Absolute Maximum Ratings

Drain Bias Voltage (Vdd1, Vdd2)	+3.5 Vdc
RF Input Power (RFIN) (Vdd = +3.0 Vdc)	+20 dBm
Channel Temperature	175 °C
Continuous P _{diss} (T= 85 °C) (derate 12.9 mW/°C above 85 °C)	1.16 W
Thermal Resistance (channel to ground paddle)	77.5 °C/W
Storage Temperature	-65 to +150 °C
Operating Temperature	-40 to +85 °C
ESD Sensitivity (HBM)	Class 1A

Typical Supply Current vs. Vdd

Vdd (V)	I _{dd} (mA)
2.5	49
3.0	51
3.5	53

Note: Amplifier will operate over full voltage ranges shown above.



**ELECTROSTATIC SENSITIVE DEVICE
OBSERVE HANDLING PRECAUTIONS**

Outline Drawing

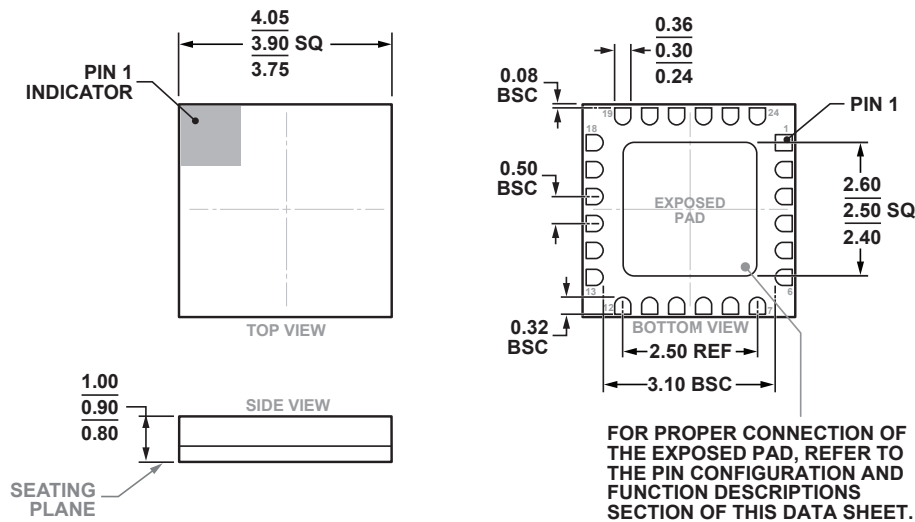

24-Terminal Ceramic Leadless Chip Carrier [LCC]
(E-24-1)
Dimensions shown in millimeters.

Package Information

Part Number	Package Body Material	Lead Finish	MSL Rating	Package Marking ^[2]
HMC564LC4	Alumina, White	Gold over Nickel	MSL3 ^[1]	H564 XXXX
HMC564LC4TR	Alumina, White	Gold over Nickel	MSL3 ^[1]	H564 XXXX
HMC564LC4TR-R5	Alumina, White	Gold over Nickel	MSL3 ^[1]	H564 XXXX

[1] Max peak reflow temperature of 260 °C

[2] 4-Digit lot number XXXX



GaAs SMT pHEMT LOW NOISE AMPLIFIER, 7 - 14 GHz

Pin Descriptions

Pin Number	Function	Description	Interface Schematic
1, 5 -14, 18, 20, 21, 22, 24	N/C	No connection required. These pins may be connected to RF/DC ground without affecting performance.	
2, 4, 15, 17	GND	These pins and package bottom must be connected to RF/DC ground.	
3	RFIN	This pin is AC coupled and matched to 50 Ohms.	
16	RFOUT	This pin is AC coupled and matched to 50 Ohms.	
19, 23	Vdd1, Vdd2	Power Supply Voltage for the amplifier. External bypass capacitors of 100 pF, and 2.2 μF are required.	

Application Circuit

Component	Value
C1, C2	100 pF
C3, C4	2.2 μF

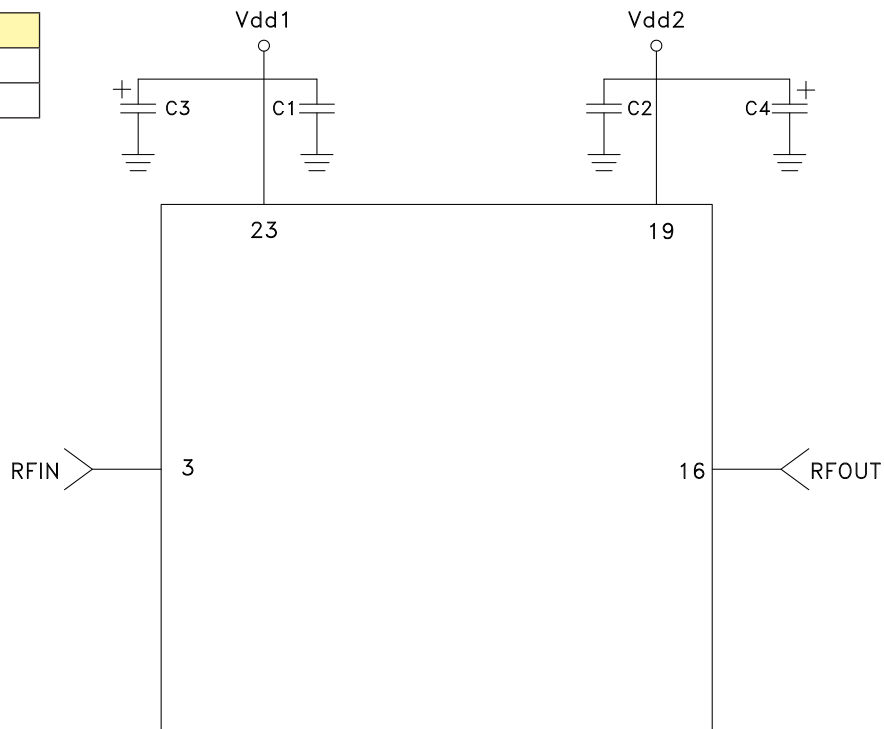

Evaluation PCB

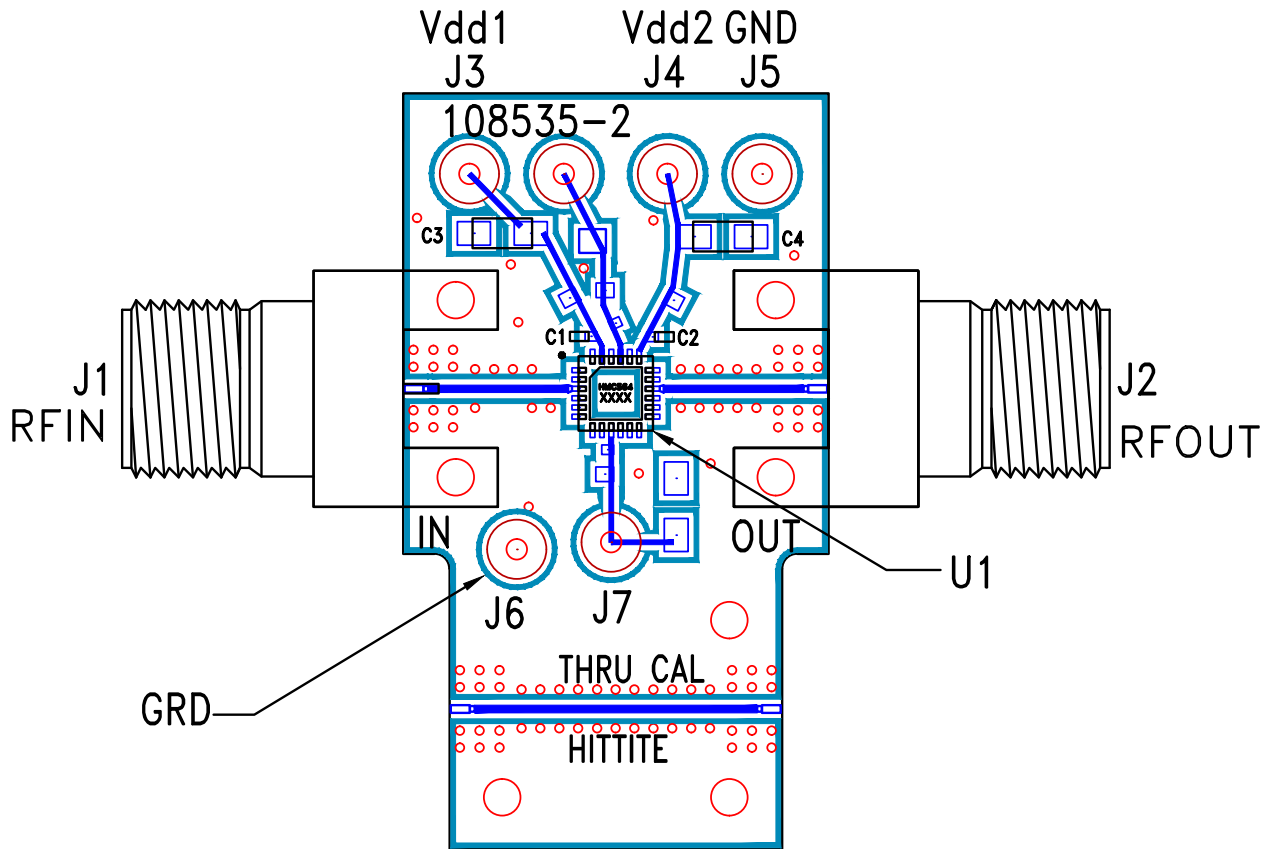

List of Material for Evaluation PCB 116156-HMC564LC4 [1]

Item	Description
J1, J2	PCB Mount K Connectorbvv
J3 - J7	DC Pin
C1 - C2	100 pF capacitor, 0402 Pkg..
C3 - C4	2.2µF Capacitor, Tantalum
U1	HMC564LC4 Amplifier
PCB [2]	108535 Evaluation PCB

[1] Reference this number when ordering complete evaluation PCB

[2] Circuit Board Material: Rogers 4350.

The circuit board used in this application should use RF circuit design techniques. Signal lines should have 50 Ohm impedance while the package ground leads and exposed paddle should be connected directly to the ground plane similar to that shown. A sufficient number of via holes should be used to connect the top and bottom ground planes. The evaluation board should be mounted to an appropriate heat sink. The evaluation circuit board shown is available from Analog Devices upon request.