



### Main

Range of product	OsiSense XM
Product or component type	Electromechanical pressure sensor
Pressure sensor type	Electromechanical pressure sensor
Device short name	XMLC
Pressure sensor size	58.02 psi (4 bar)
Controlled fluid	Air (32...320 °F (0...160 °C)) Fresh water (32...320 °F (0...160 °C)) Hydraulic oil (32...320 °F (0...160 °C))
Fluid connection type	G 1/4 (female) conforming to ISO 228
Electrical connection	Screw-clamps terminals 1 x 0.5...2 x 2.5 mm <sup>2</sup>
AWG gauge	AWG 20...AWG 14
Cable entry	Cable gland 9...13 mm
Contacts type and composition	2 C/O
Product specific application	30 bar overpressure
Pressure switch type of operation	Regulation between 2 thresholds
Electrical circuit type	Control circuit
Scale type	Adjustable differential
Local display	With
Adjustable range of switching point on rising pressure	4.35...58.02 psi (0.3...4 bar)
Adjustable range of switching point on falling pressure	2.9...54.39 psi (0.2...3.75 bar)
Possible differential maximum at 31.91 psi (2.2 bar) high setting	
Maximum permissible accidental pressure	543.89 psi (37.5 bar)
Destruction pressure	979 psi (67.5 bar)
Pressure actuator	Diaphragm
Materials in contact with fluid	FPM, FKM Steel
Enclosure material	Zinc alloy
[In] rated current	3 A, B300, AC-15 (Ue = 120 V) conforming to EN/IEC 60947-5-1 1.5 A, B300, AC-15 (Ue = 240 V) conforming to EN/IEC 60947-5-1 0.1 A, R300, DC-13 (Ue = 250 V) conforming to EN/IEC 60947-5-1

### Complementary

Possible differential minimum at low setting	1.45 psi (0.1 bar) (+/- 0.02 bar)
Possible differential minimum at high setting	2.61 psi (0.18 bar) (+/- 0.03 bar)
Maximum permissible pressure - per cycle	435.11 psi (30 bar)
Terminal block type	8 terminals
Operating rate	120 cyc/mn
Repeat accuracy	< 2 %
[Ui] rated insulation voltage	500 V conforming to EN/IEC 60947-1 300 V conforming to UL 508 300 V conforming to CSA C22.2 No 14
[Uimp] rated impulse withstand voltage	6 kV conforming to EN/IEC 60947-1
Auxiliary contacts operation	Simultaneous, snap action
Contacts material	Silver contacts
Resistance across terminals	< 25 mOhm conforming to IEC 255-7 category 3 < 25 mOhm conforming to NF C 93-050 method A

The information provided in this documentation contains general descriptions and/or technical characteristics of the performance of the products contained herein. This documentation is not intended as a substitute for and is not to be used for determining suitability or reliability of these products for specific user applications. It is the duty of any such user or integrator to perform the appropriate and complete risk analysis, evaluation and testing of the products with respect to the relevant specific application or use thereof. Neither Schneider Electric Industries SAS nor any of its affiliates or subsidiaries shall be responsible or liable for misuse of the information contained herein.

Short-circuit protection	10 A cartridge fuse type gG (gl)
Mechanical durability	2000000 cycles
Setting	External
Height	4.45 in (113 mm)
Depth	3.35 in (85 mm)
Width	1.81 in (46 mm)
Product weight	7.72 lb(US) (3.5 kg)

## Environment

standards	CE EN/IEC 60947-5-1 UL 508 CSA C22.2 No 14
product certifications	CSA UL EAC
protective treatment	TC (standard version)
ambient air temperature for operation	-13...158 °F (-25...70 °C)
ambient air temperature for storage	-40...158 °F (-40...70 °C)
operating position	Any position
vibration resistance	4 gn (f = 30...500 Hz) conforming to IEC 60068-2-6
shock resistance	50 gn conforming to IEC 60068-2-27
electrical shock protection class	Class I conforming to IEC 1140 Class I conforming to IEC 536 Class I conforming to NF C 20-030
IP degree of protection	IP66 conforming to EN/IEC 60529

## Offer Sustainability

Not Green Premium product	Not Green Premium product
Compliant - since 0928 - Schneider Electric declaration of conformity	Compliant - since 0928 - Schneider Electric declaration of conformity
Reference not containing SVHC above the threshold	Reference not containing SVHC above the threshold
Need no specific recycling operations	Need no specific recycling operations
WARNING: This product can expose you to chemicals including:	WARNING: This product can expose you to chemicals including:
Diisononyl phthalate (DINP), which is known to the State of California to cause cancer, and	Diisononyl phthalate (DINP), which is known to the State of California to cause cancer, and
Di-isodecyl phthalate (DIDP), which is known to the State of California to cause birth defects or other reproductive harm.	Di-isodecyl phthalate (DIDP), which is known to the State of California to cause birth defects or other reproductive harm.
For more information go to <a href="http://www.p65warnings.ca.gov">www.p65warnings.ca.gov</a>	For more information go to <a href="http://www.p65warnings.ca.gov">www.p65warnings.ca.gov</a>

## Contractual warranty

Warranty period	18 months
-----------------	-----------

## Dimensions

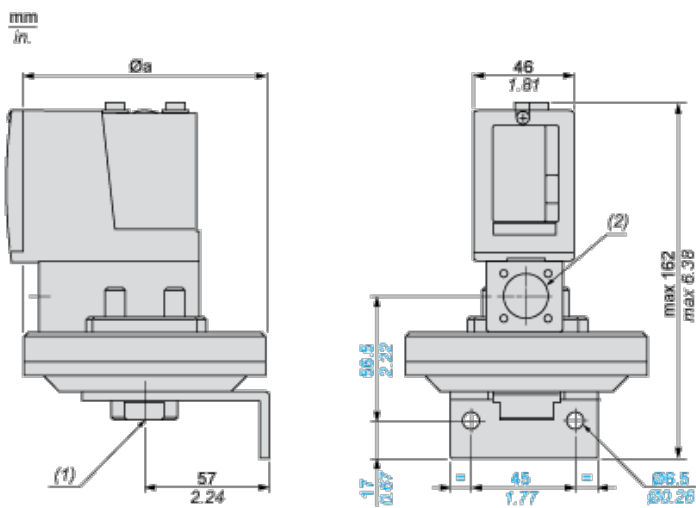

Ø a 110 mm / 4.33 in.

=

- (1) 1 fluid entry, tapped G1/4 (BSP female)
- (2) 1 electrical connections entry, tapped Pg 13.5

## Wiring Diagram

### Terminal Model



## Operating Curves

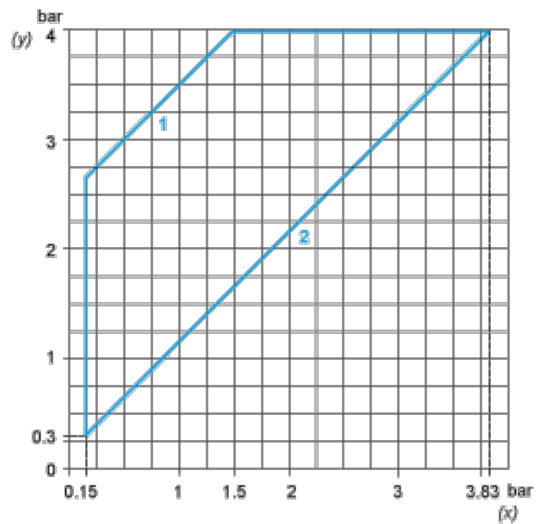

- (y) Rising pressure
- (x) Falling pressure
- 1 : Maximum differential
- 2 : Minimum differential



- (y) Pressure
- (x) Time
- (1) Adjustable value
- PH : High point
- PB : Below point