



Microtips

T E C H N O L O G Y

Model No: MVÖ€J€€ÖZS

TEL: 1-888-499-TIPS (8477)

FAX: (407) 273-0771

E-MAIL: mtusainfo@microtipsusa.com

WEB: www.microtipsusa.com

Record of Revision

Date	Revision No.	Summary
2017-04-17	1.0	Rev 1.0 was issued

1. Scope

This data sheet is to introduce the specification of **MTD0900GZK** active matrix TFT module. It is composed of a color TFT-LCD panel, driver ICs, FPC and a backlight unit. The 9.0" display area contains 1024(RGB) x 600 pixels.

2. Application

Digital equipments which need color display, mobile navigator/video systems.

3. General Information

Item	Contents	Unit
Size	9.0	inch
Resolution	1024(RGB) x 600	/
Interface	LVDS	/
Technology type	IPS	/
Pixel pitch	0.1920 x 0.1902	mm
Pixel Configuration	RGB stripes	
Outline Dimension (W x H x D)	211.1 x 126.5 x 5.7	mm
Active Area	196.608 x 114.15	mm
Display Mode	Transmissive Normally Black,	/
Backlight Type	LED	/

4. Outline Drawing

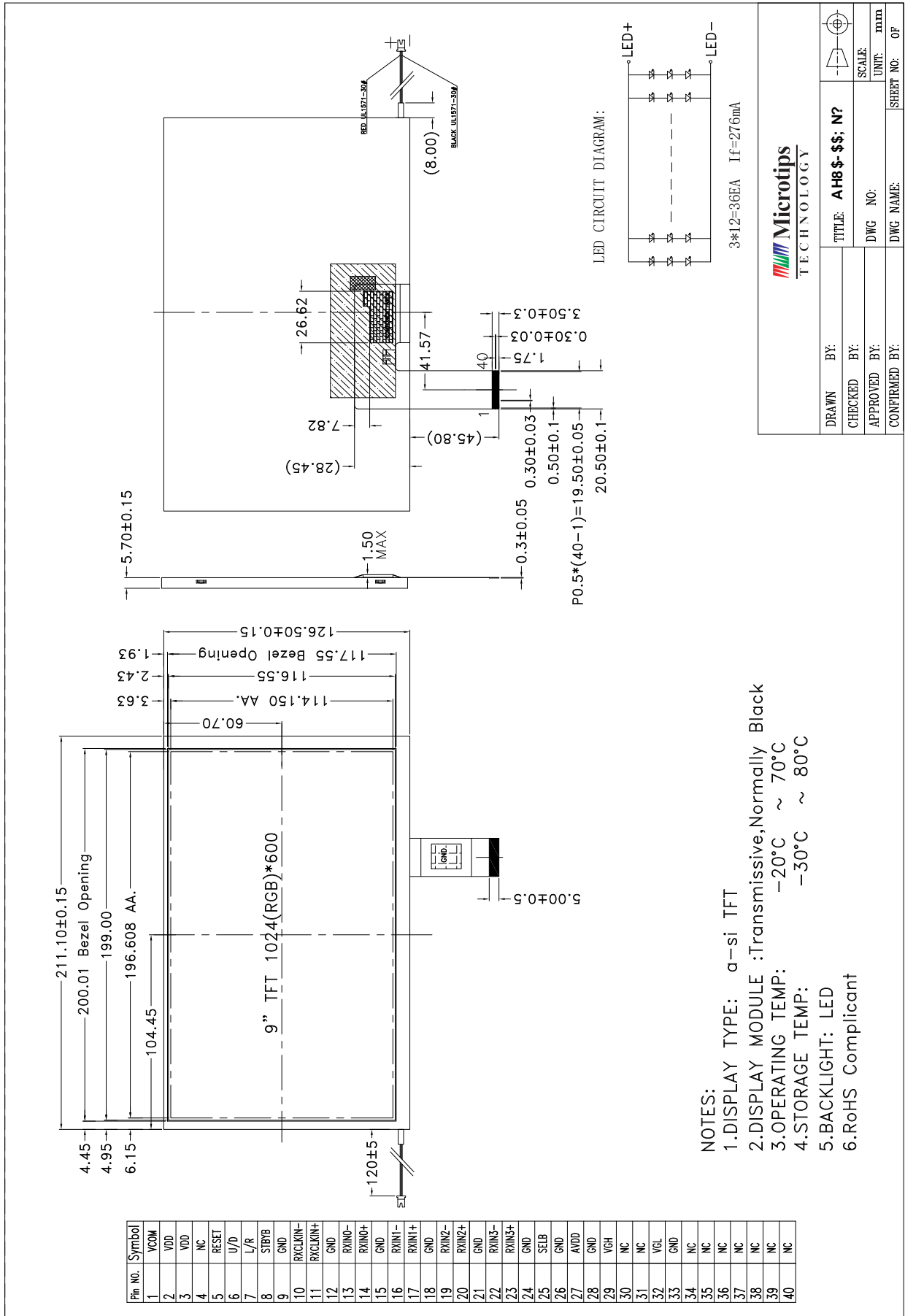

DRAWN BY:	TITLE: AH8-\$-\$; N?	SCALE:	mm
CHECKED BY:	DWG NO:	UNITS:	mm
APPROVED BY:	DWG NAME:	SHEET NO:	0F
CONFIRMED BY:			

5. Interface signals

FPC Connector is used for the module electronics interface. The recommended model is FH12A-40S-0.5SH manufactured by Hirose.

Pin No.	Symbol	I/O	Function	Remark
1	VCOM	P	Common Voltage	
2	VDD	P	Power Voltage for digital circuit	
3	VDD	P	Power Voltage for digital circuit	
4	NC	-	No connection	
5	Reset	I	Global reset pin	
6	U/D	I	Vertical inversion	Note 2
7	L/R	I	Horizontal inversion	Note 2
8	STBYB	I	Standby mode, Normally pulled high STBYB="1", normal operation; STBYB="0", timing controller, source driver will turn off, all output are High-Z	
9	GND	P	Ground	
10	NINC	I	- LVDS differential clock input	
11	PINC	I	+ LVDS differential clock input	
12	GND	P	Ground	
13	RXIN0-	I	- LVDS differential data input	
14	RXIN0+	I	+ LVDS differential data input	
15	GND	P	Ground	
16	RXIN1-	I	- LVDS differential data input	
17	RXIN1+	I	+ LVDS differential data input	
18	GND	P	Ground	
19	RXIN2-	I	- LVDS differential clock input	
20	RXIN2+	I	+ LVDS differential clock input	
21	GND	P	Ground	
22	RXIN3-	I	- LVDS differential data input	
23	RXIN3+	I	+ LVDS differential data input	
24	GND	P	Ground	
25	SELB	I	6bit/8bit mode select	Note 1
26	GND	P	Ground	
27	AVDD	P	Power for Analog Circuit	
28	GND	P	Ground	
29	VGH	P	Gate On Voltage	
30	BIST	-	Normal Operation/BIST pattern select BIST=H : BIST(DCLK input is not needed) BIST=L : Normal Operation (Default)	
31	NC	-	No Connection	
32	VGL	P	Gate OFF Voltage	
33	GND	P	Ground	
34	NC	-	No Connection	

35	NC	-	No Connection	
36	NC	-	No Connection	
37	NC	-	No Connection	
38	NC		No Connection	
39	NC		No Connection	
40	NC		No Connection	

I: Input, o: output, p: power

Note 1: If LVDS input data is 6 bits, SELB must be set to High;

If LVDS input data is 8 bits, SELB must be set to Low.

When CABC off, don't connect DIMO, else connect it to backlight.

Note 2: When L/R="0", set right to left scan direction.

When L/R="1", set left to right scan direction.

When L/R="0", set top to bottom scan direction.

When L/R="1", set bottom to top scan direction.

6. Absolute maximum Ratings

6.1. Electrical Absolute max. ratings

Item	Symbol	Values			Unit	Remark
		MIN	TYP	MAX		
Digital Supply Voltage	VDD VDD_LVDS	-0.3	-	5	V	
Analog Supply Voltage	AVDD	-0.5	-	15	V	
Gate On Voltage	VGH	-0.3	-	25	V	
Gate Off Voltage	VGL	-20	-	0.3	V	
Gate On-Gate off Voltage	VGH-VGL	-0.3	-	40	V	

6.2. Environment Conditions

Item	Symbol	MIN	MAX	Unit	Remark
Operating Temperature	TOPR	-20	70	°C	
Storage Temperature	TSTG	-30	80	°C	

7. Electrical Specifications

7.1 Electrical characteristics

Item	Symbol	Values			Unit	Remark
		MIN	TYP	MAX		
Digital Supply Voltage	VDD	3.0	3.3	3.6	V	Note
TFT Gate ON Voltage	VGH	22	23	24	V	
TFT Gate OFF Voltage	VGL	-11	-10	-9	V	
TFT Common Electrode Voltage	VCOM	5.20	5.45	5.60	V	
Analog Power Supply Voltage	AVDD	12.2	12.5	12.8	V	

Note: TYP VCOM is only reference value. It must be optimized according to each LCM. Be sure to use VR and OP buffer on VCOM output. Please adjust VCOM to make the flicker level be minimum for getting excellent image.

7.2 Current Consumption

Item	Symbol	Condition	Values			Unit	Remark
			MIN	TYP	MAX		
Gate on Current	IVGH	VGH=23V	-	0.5	-	mA	
Gate off Current	IVGL	VGL=-10V	-	2.0	-	mA	
Digital Current	IVDD	VDD=3.3V	-	22	-	mA	
Analog Current	IAVDD	AVDD=12.5V	-	42	-	mA	

7.3 LED Backlight

Item	Symbol	Values			Unit	Remark
		MIN	TYP	MAX		
LED Current	I _{LED}	-	276	-	mA	Total LED
Forward Voltage	V _F	8.4	9.6	10.5	V	I _F =276mA
Reverse Current	I _r	-	-	50	μA	V _R =5V, 1LED
Power dissipation	P _d	2650			mW	Total LED
Peak forward current	I _{fp}	100			mA	1LED
Reverse voltage	V _R	5			V	1LED

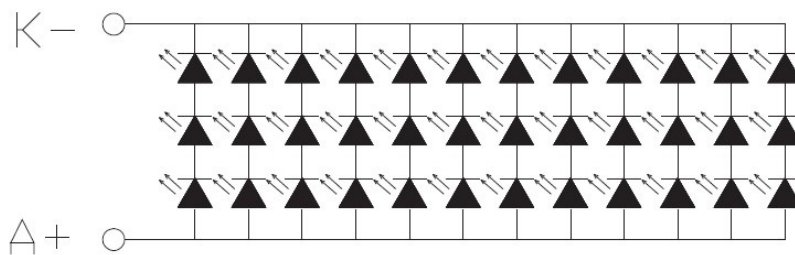

$$3 * 12 = 36EA \quad I_f = 276mA$$

8. Command/AC Timing

8.1 AC Electrical Characteristics

LVDS Mode AC Electrical Characteristics

(TA=-20 to 85°C, VDD=2.3 to 3.6V, AVDD=8 to 13.5V, GND=AGND=0V)

Parameter	Symbol	Condition	MIN	MAX	Unit	Remark
Clock Frequency	RxFCLK		20		71	MHz
Input data skew margin	TRSKM	VID =400Mv RxVCM=1.2V RxFCLK=71MHz	500			ps
Clock High Time	TLVCH			4/(7*RxFCLK)		ns
Clock Low Time	TLVCL			3/(7*RxFCLK)		ns
PLL wake-up-time	TenPLL				150	ns

8.2 DC Electrical Characteristics

LVDS Mode DC Electrical Characteristics

(TA=-20 to 85°C, VDD=2.3 to 3.6V, AVDD=8 to 13.5V, GND=AGND=GND_LVDS=0V)

Parameter	Symbol	Condition	MIN	MAX	Unit	Remark
Differential input high threshold voltage	RxVTH	RxVCM=1.2V			+0.1V	V
Differential input Low threshold voltage	RxVTL		-0.1			V
Input voltage range(single-end)	RxVIN		0		2.4	V
Differential input common mode voltage	RxVCM		VID /2		2.4- VID /2	V
Differential input voltage	VID		0.2		0.6	V
Differential input leakage current	RxVTH		-10		+10	V
LVDS Digital Operating current	Iddlvsd	Fclk=65Mhz, VDD=3.3v	-	40(TBD)	50	mA
LVDS Digital Standby current	Istlvds	Clock & all functions are stop	-	10(TBD)	50	uA

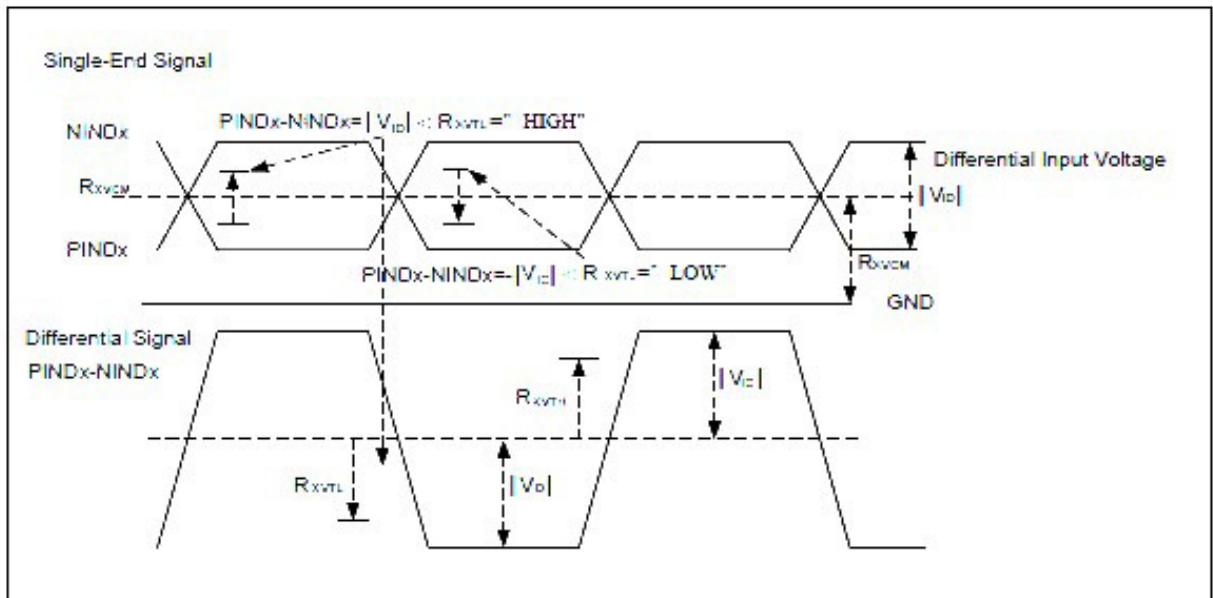

8.3 LVDS Data Input Format
8.3.1 6-bits LVDS Input (HSD=H)

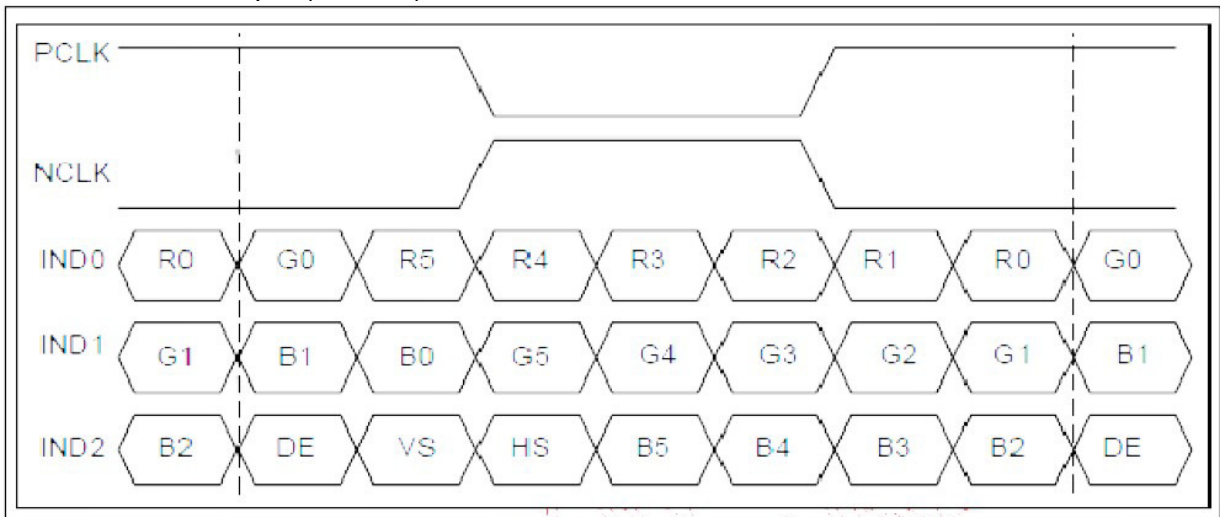

8.3.2 8-bits LVDS Input (HSD=L)

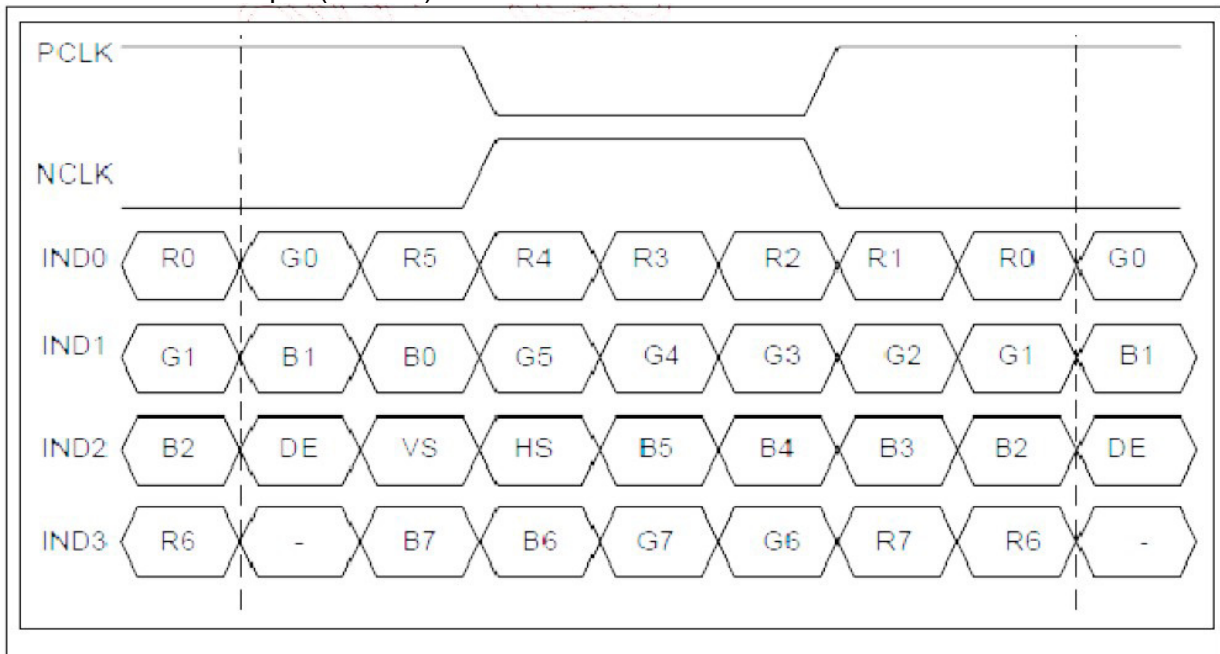

8.4 Input Timing Table

8.4.1 DE Mode

Parameter	Symbol	Value			Unit
		Min	Typ	Max	
DCLK frequency @Frame rate=60hz	fclk	40.8	51.2	67.2	Mhz
Horizontal display area	thd	1024			DCLK
HSYNC period time	th	1114	1344	1400	DCLK
HSYNC blanking	thb+thfp	90	320	376	DCLK
Vertical display area	tvd	600			H
VSYNC period time	tv	610	635	800	H
VSYNC blanking	tvb+tvfp	10	35	200	H

8.4.2 HV Mode

Horizontal Timing

Parameter		Symbol	Value			Unit
			Min	Typ	Max	
DCLK frequency @Frame rate=60hz		fclk	44.9	51.2	63	Mhz
Horizontal display area		thd	1024			DCLK
1 Horizontal Line		th	1200	1344	1400	
HSYNC pulse width	Min.	thpw	1			
	Typ.		-			
	Max.		140			
HSYNC back porch		thbp	160	160	160	
HSYNC front porch		thfp	16	160	216	

Vertical Timing

Parameter	Symbol	Value			Unit
		Min	Typ	Max	
Vertical display area	tvd	600			H
VSYNC period time	tv	624	635	750	H
VSYNC pulse width	tvpw	1	-	20	H
VSYNC back porch	tvb	23	23	23	H
VSYNC front porch	tvfp	1	12	127	H

8.5 Power ON/OFF Sequence

In order to prevent IC from power on reset fail, the rising time (TPOR) of the digital power supply VDD should be maintained within the given specifications. Refer to “AC Characteristics” for more detail on timing.

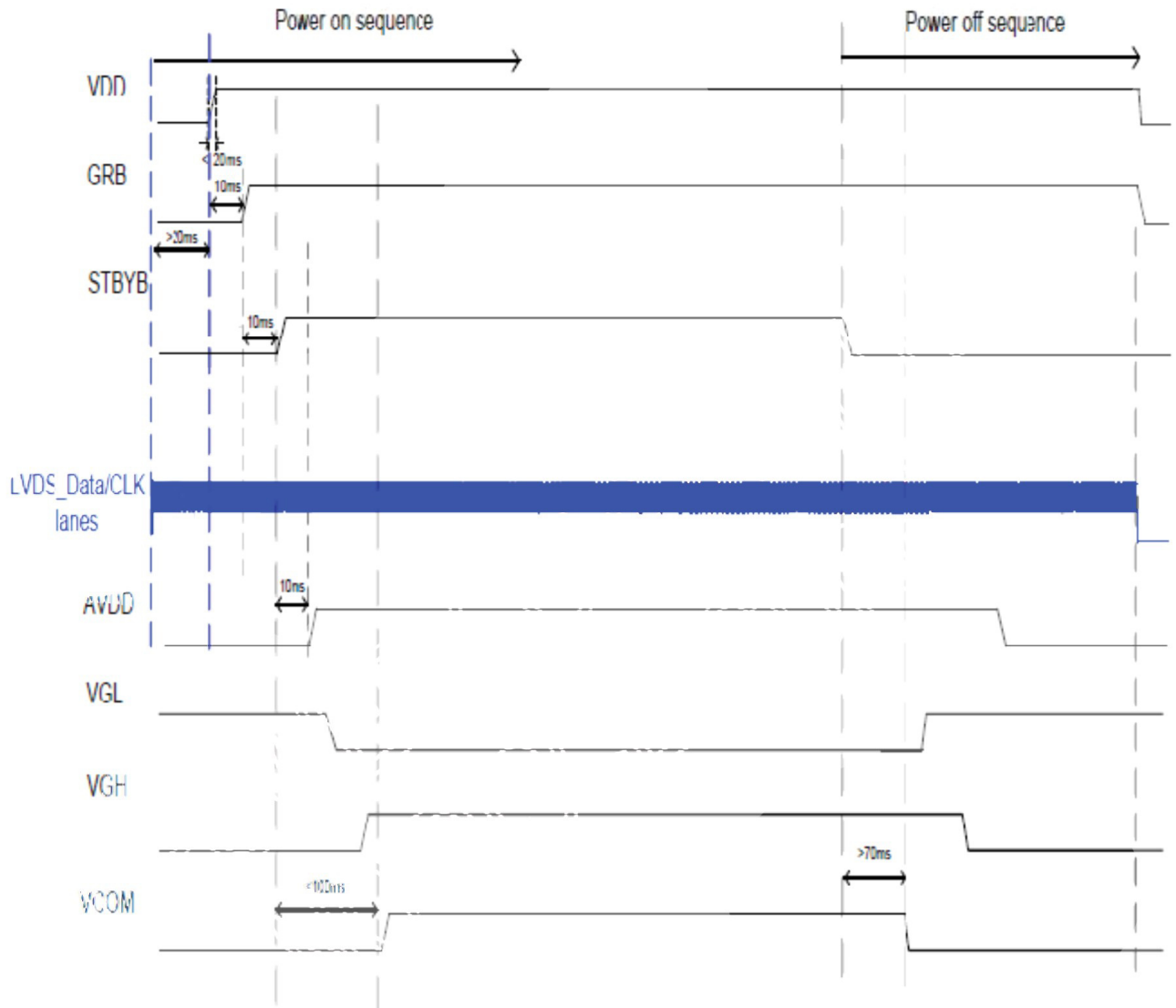

9 Optical Specification

Ta=25°C

Item	Symbol	Condition	Min	Typ.	Max.	Unit	Remark	
Contrast Ratio	CR	$\theta=0^\circ$	-	600			Note1 Note2	
Response Time	Ton/ Toff	$\theta=0^\circ$	-	20	40	ms	Note1 Note3	
View Angles	θT	$CR \geq 10$	80	85	-	Degree	Note4	
	θB		80	85	-			
	θL		80	85	-			
	θR		80	85	-			
Chromaticity	White	Brightness is on	x	0.254	0.304	0.354	-	Note5, Note1
			y	0.294	0.344	0.394		
	Red		x	0.561	0.611	0.661		
			y	0.305	0.355	0.405		
	Green		x	0.252	0.302	0.352		
			y	0.536	0.586	0.636		
	Blue		x	0.096	0.146	0.196		
			y	0.067	0.117	0.167		
Luminance	L		400	450	-	cd/m ²	Note1 Note6	
Uniformity	U		70	75	-	%	Note1 Note7	

Note 1: Definition of optical measurement system.

Temperature = 25°C(±3°C)

LED back-light: ON, Environment brightness < 150 lx

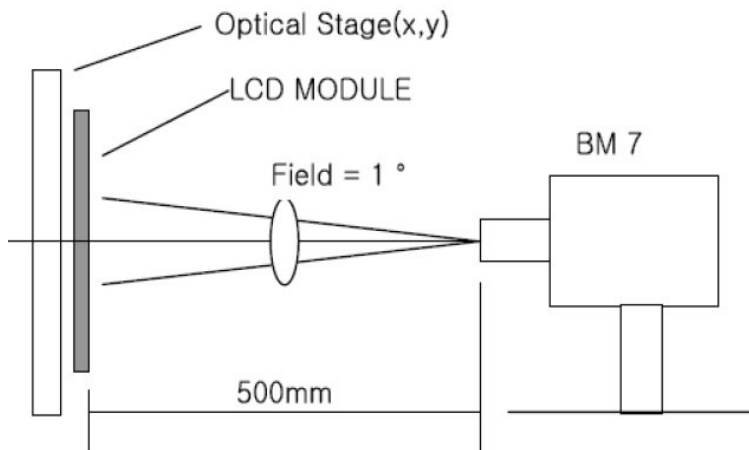

Note 2: Contrast ratio is defined as follow:

$$\text{Contrast Ratio} = \frac{\text{Surface Luminance with all white pixels}}{\text{Surface Luminance with all black pixels}}$$

Note 3: Response time is defined as follow:

Response time is the time required for the display to transition from black to white (Rise Time, T_r) and from white to black (Decay Time, T_f).

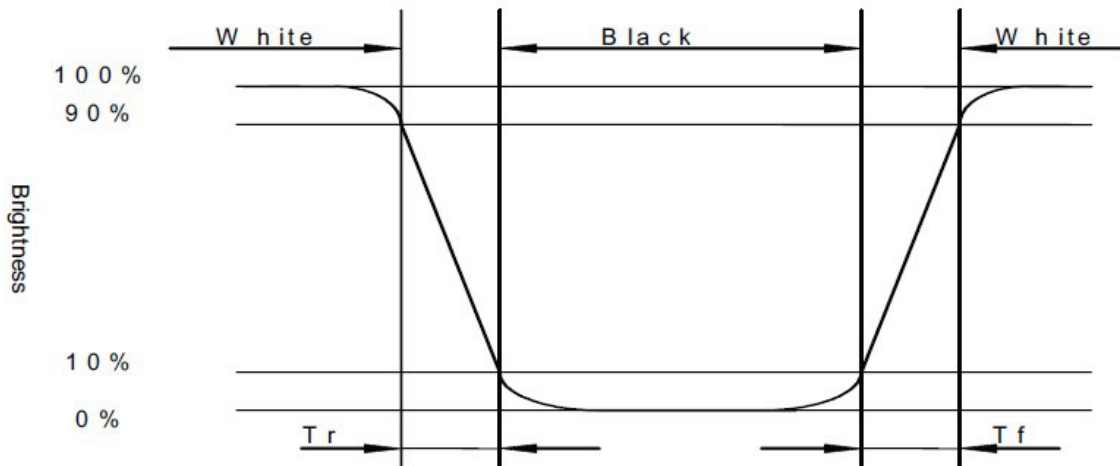

Note 4: Viewing angle range is defined as follow:

Viewing angle is measured at the center point of the LCD.

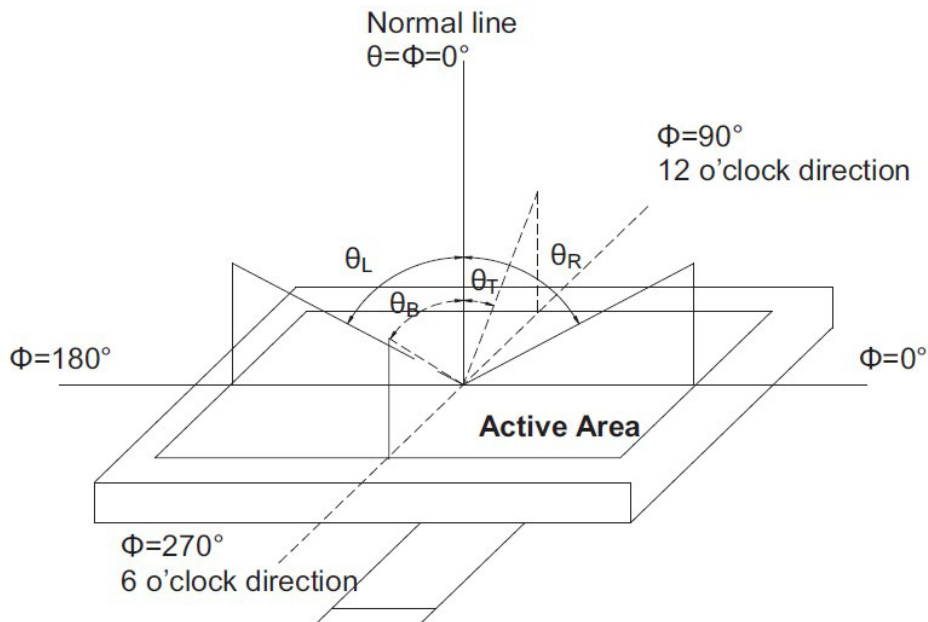

Note 5: Color chromaticity is defined as follow: (CIE1931)

Color coordinates measured at center point of LCD.

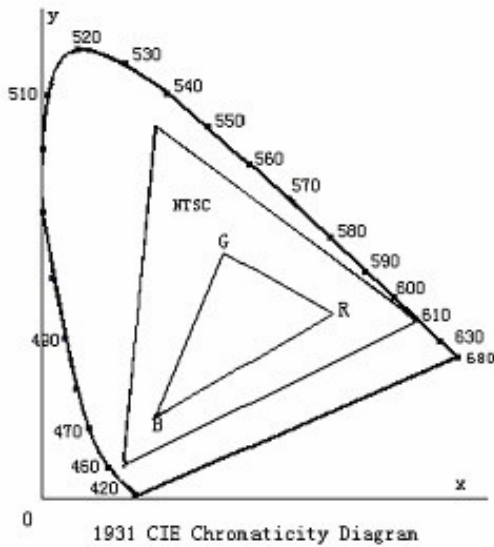

$$S = \frac{\text{area of RGB triangle}}{\text{area of NTSC triangle}} \times 100\%$$

Note 6: Luminance is defined as follow:

Luminance is defined as the brightness of all pixels “White” at the center of display area on optimum contrast.

Note 7: Luminance Uniformity is defined as follow:

Active area is divided into 9 measuring areas (Refer Fig. 2). Every measuring point is placed at the center of each measuring area.

$$\text{Uniformity (U)} = \frac{\text{Minimum Luminance(brightness) in 9 points}}{\text{Maximum Luminance(brightness) in 9 points}}$$

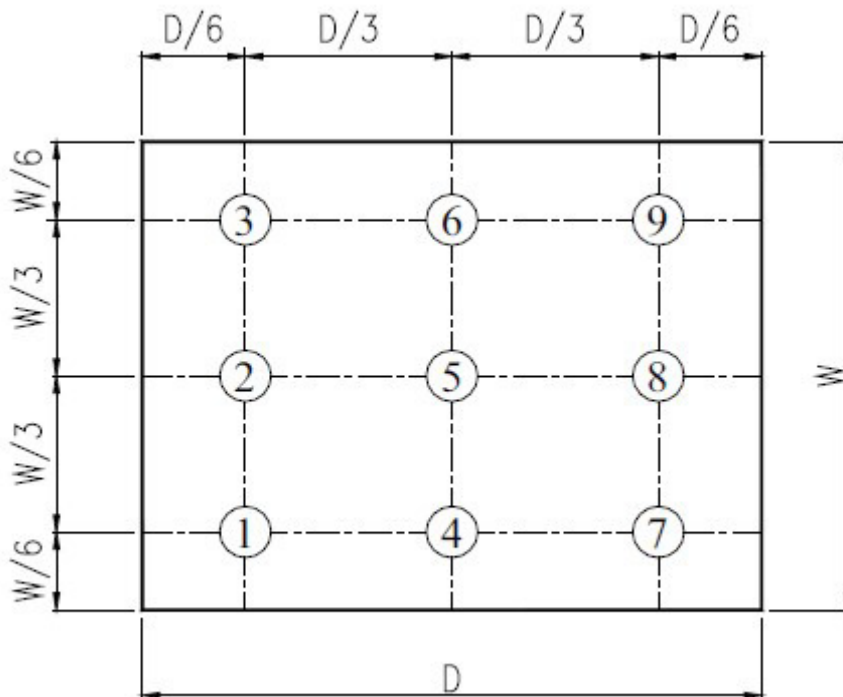

Fig. 2 Definition of uniformity

10 Environmental / Reliability Tests

No	Test Item	Condition	Judgment criteria
1	High Temp Operation	Ts=+70°C, 120hrs	Per table in below
2	Low Temp Operation	Ta=-20°C, 120hrs	Per table in below
3	High Temp Storage	Ta=+80°C, 120hrs	Per table in below
4	Low Temp Storage	Ta=-30°C, 120hrs	Per table in below
5	High Temp & High Humidity Storage	Ta=+60°C, 90% RH 120hours	Per table in below (polarizer discoloration is excluded)
6	Thermal Shock (Non-operation)	-30°C 30 min~+80°C 30 min, Change time:5min, 5 Cycles	Per table in below
7	ESD (Non-Operation)	150Pf,330Ω,Contact :±4KV,Air:±8KV 200pF,0Ω,±200V contact test	Per table in below
8	Vibration (Non-operation)	Frequency range: 10HZ~50HZ Stroke: 1.0mm, Sweep:10 HZ~50HZ , X, Y, Z 1 hours for each direction	Per table in below
9	Shock (Non-operation)	980m/s ² , 6ms, ±X, Y, Z 3times for direction	Per table in below
10	Package Drop Test	Height:80 cm, 1 corner, 3 edges, 6 surfaces	Per table in below

INSPECTION	CRITERION(after test)
Appearance	No Crack on the FPC, on the LCD Panel
Alignment of LCD Panel	No Bubbles in the LCD Panel No other Defects of Alignment in Active area
Electrical current	Within device specifications
Function / Display	No Broken Circuit, No Short Circuit or No Black line No Other Defects of Display

11 Precautions for Use of LCD Modules

11.1 Safety

The liquid crystal in the LCD is poisonous. Do not put it in your mouth. If the liquid crystal touches your skin or clothes, wash it off immediately using soap and water.

11.2 Handling

A. The LCD and touch panel is made of plate glass. Do not subject the panel to mechanical shock or to excessive force on its surface.

B. Do not handle the product by holding the flexible pattern portion in order to assure the reliability

C. Transparency is an important factor for the touch panel. Please wear clear finger sacks, gloves and mask to protect the touch panel from finger print or stain and also hold the portion outside the view area when handling the touch panel.

D. Provide a space so that the panel does not come into contact with other components.

E. To protect the product from external force, put a covering lens (acrylic board or similar board) and keep an appropriate gap between them.

F. Transparent electrodes may be disconnected if the panel is used under environmental conditions where dew condensation occurs.

G. Property of semiconductor devices may be affected when they are exposed to light, possibly resulting in IC malfunctions.

H. To prevent such IC malfunctions, your design and mounting layout shall be done in the way that the IC is not exposed to light in actual use.

11.3 Static Electricity

A. Ground soldering iron tips, tools and testers when they are in operation.

B. Ground your body when handling the products.

C. Power on the LCD module before applying the voltage to the input terminals.

D. Do not apply voltage which exceeds the absolute maximum rating.

E. Store the products in an anti-electrostatic bag or container.

F. Peel off the LCM protective film slowly since static electricity may be generated.

11.4 Storage

A. Store the products in a dark place at $+25^{\circ}\text{C} \pm 10^{\circ}\text{C}$ with low humidity (40% RH to 60% RH). Don't expose to sunlight or fluorescent light.

B. Storage in a clean environment, free from dust, active gas, and solvent.

11.5 Cleaning

A. Do not wipe the touch panel with dry cloth, as it may cause scratch.

B. Wipe off the stain on the product by using soft cloth moistened with ethanol. Do not allow ethanol to get in between the upper film and the bottom glass. It may cause peeling issue or defective operation. Do not use any organic solvent or detergent other than ethanol.

11.6 Cautions for installing and assembling

Bezel edge must be positioned in the area between the Active area and View area. The bezel may press the touch screen and cause activation if the edge touches the active area. A gap of approximately 0.5mm is needed between the bezel and the top electrode. It may cause unexpected activation if the gap is too narrow. There is a tolerance of 0.2 to 0.3mm for the outside dimensions of the touch panel and tail. A gap must be made to absorb the tolerance in the case and connector.

