

Series: Ceramic Chip

Description:
2.5-2.69GHz Ceramic SMT Antenna

PART NUMBER: W3020

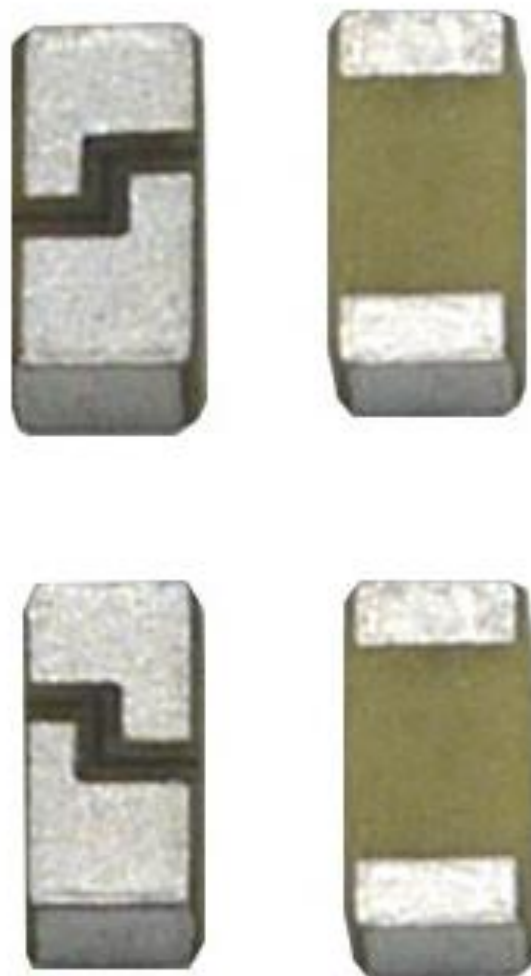

Features:

- Omnidirectional radiation
- Low profile
- Compact size:
W x L x H (3.2 x 1.6 x 1.1mm)
- Fully SMD compatible
- Lead free soldering compatible
- Tape and reel packing
- RoHS compliant
- Moisture Sensitivity Level MSL3

Applications:

- 2.5-2.69 GHz Radios
- LTE B38, B41
- Devices needing smallest form factor high performing miniature antenna

All dimensions are in mm / inches

Issue: 1821

In the effort to improve our products, we reserve the right to make changes judged to be necessary.

CONFIDENTIAL AND PROPRIETARY INFORMATION

This document contains confidential and proprietary information of Pulse Electronics, Inc. (Pulse) and is protected by copyright, trade secret and other state and federal laws. Its receipt or possession does not convey any rights to reproduce, disclose its contents, or to manufacture, use or sell anything it may describe. Reproduction, disclosure or use without specific written authorization of Pulse is strictly forbidden.

For more information:

Pulse Worldwide Headquarters
15255 Innovation Drive #100
San Diego, CA 92128
USA
Tel: 1-858-674-8100

Pulse/Larsen Antennas
18110 SE 34th St Bldg 2 Suite 250
Vancouver, WA 98683
USA
Tel: 1-360-944-7551

Europe Headquarters
Pulse GmbH & Do, KG
Zeppelinstrasse 15
Herrenberg, Germany
Tel: 49 7032 7806 0

Pulse (Suzhou) Wireless Products Co, Inc.
99 Huo Ju Road(#29 Bldg,4th Phase
Suzhou New District
Jiangsu Province, Suzhou 215009 PR China
Tel: 86 512 6807 9998



Series: Ceramic Chip

Description:
2.5-2.69GHz Ceramic SMT Antenna

PART NUMBER: W3020

ELECTRICAL SPECIFICATIONS

Frequency	2.5-2.69 GHz
Nominal Impedance	50 Ω
Return Loss(Typical)*	<-5.5dB
Max Gain*	2.9dBi (Peak) 1.5dBi (Band Edges)
Radiation Efficiency*	89%/-0.52dB (Peak) 72%/-1.43dB(Band Edges)

Note: Electrical characteristics depend on test board (GP) size and antenna positioning on GP and Ground Clearance area size.

**Tested on PULSE test board position 1 (refer to page 10) . The testboard size 80x35 mm, PCB ground clearance area 4.0 x 6.25 mm. 1.0pF shunt matcing capacitor used.*

Issue: 1821

In the effort to improve our products, we reserve the right to make changes judged to be necessary.

CONFIDENTIAL AND PROPRIETARY INFORMATION

This document contains confidential and proprietary information of Pulse Electronics, Inc. (Pulse) and is protected by copyright, trade secret and other state and federal laws. Its receipt or possession does not convey any rights to reproduce, disclose its contents, or to manufacture, use or sell anything it may describe. Reproduction, disclosure or use without specific written authorization of Pulse is strictly forbidden.

Description:
2.5-2.69GHz Ceramic SMT Antenna

Series: Ceramic Chip

PART NUMBER: W3020

MECHANICAL SPECIFICATIONS

Weight	0.033 g
Size	3.2 x1.6 x 1.1mm

ENVIRONMENTAL SPECIFICATIONS

Operating temperature	-40~+85° C
Temperature	-40~+85° C
Humidity	Cyclic 6 +25° C/+55° C 95%
Vibration	
Sinusoidal 2-8Hz	7.5 mm
Sinusoidal 8-200Hz	20 m/s ²
Shocks	0.5 m/s
Salt mist	96 hours

Series: Ceramic Chip

Description:
2.5-2.69GHz Ceramic SMT Antenna

PART NUMBER: W3020

MECHANICAL DRAWING AND TERMINAL CONFIGURATION

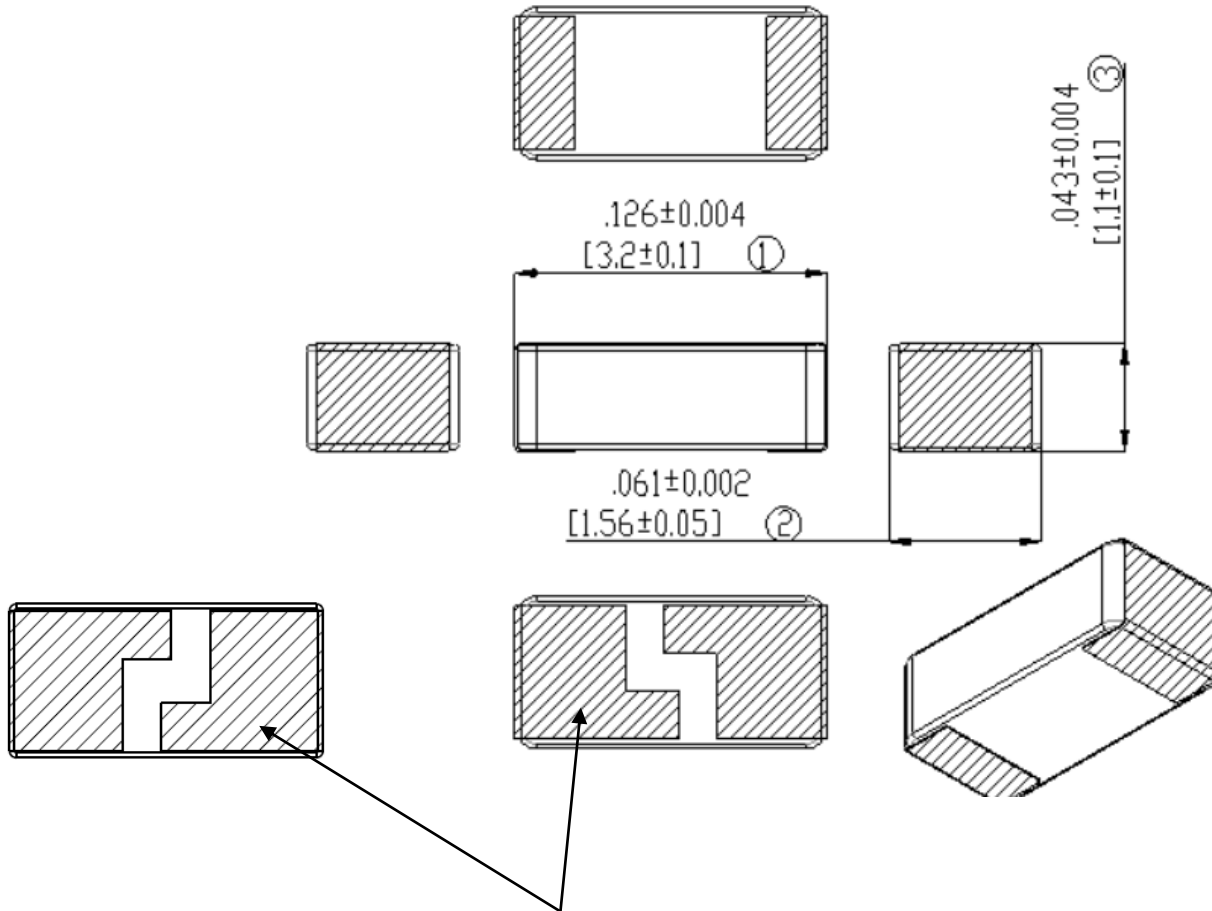

1. Antenna is symmetrical, both of antenna pattern have same RF performance.
2. The size of slot is only for reference.

Issue: 1821

In the effort to improve our products, we reserve the right to make changes judged to be necessary.
CONFIDENTIAL AND PROPRIETARY INFORMATION

This document contains confidential and proprietary information of Pulse Electronics, Inc. (Pulse) and is protected by copyright, trade secret and other state and federal laws. Its receipt or possession does not convey any rights to reproduce, disclose its contents, or to manufacture, use or sell anything it may describe. Reproduction, disclosure or use without specific written authorization of Pulse is strictly forbidden.

Description:
2.5-2.69GHz Ceramic SMT Antenna
PART NUMBER: W3020

Series: Ceramic Chip

MECHANICAL DRAWING AND TERMINAL CONFIGURATION

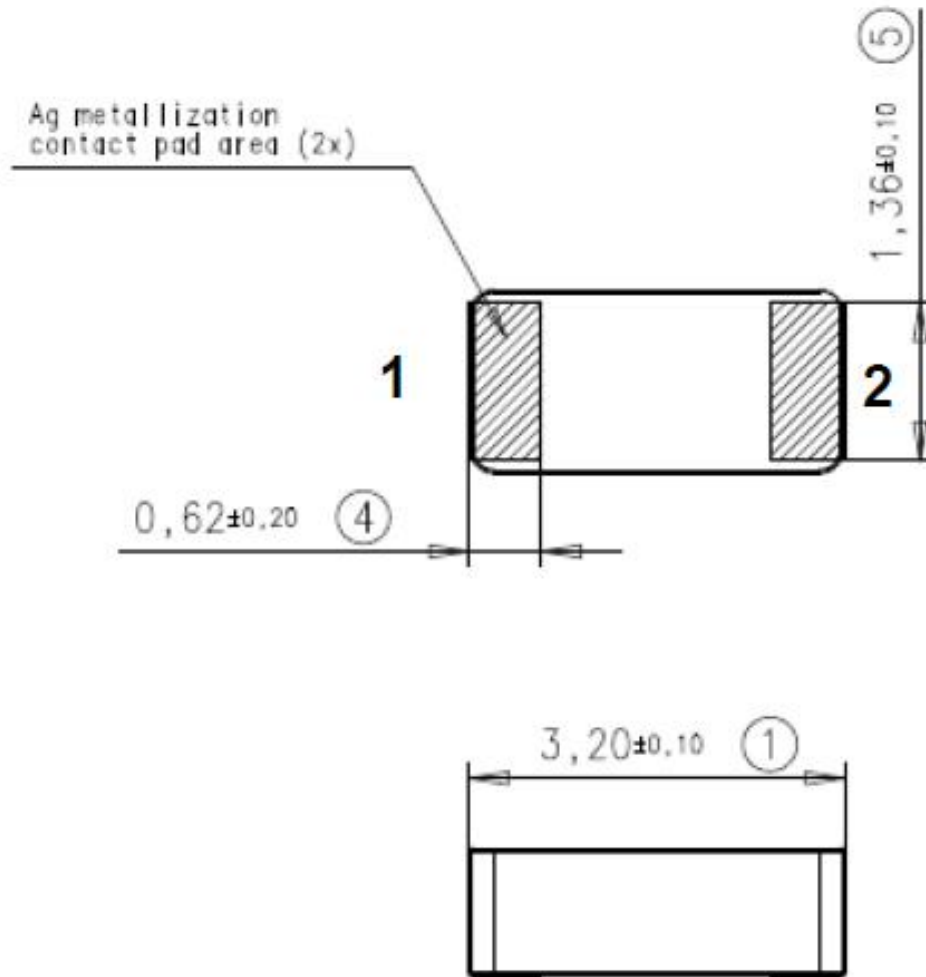

No.	Terminal Name	Terminal Dimensions
1	Feed / GND	0.62 x 1.36 mm
2	Feed / GND	0.62 x 1.36 mm
Antenna is symmetrical. Either of terminals 1 or 2 can be Feed / GND		

Issue: 1821

In the effort to improve our products, we reserve the right to make changes judged to be necessary.

CONFIDENTIAL AND PROPRIETARY INFORMATION

This document contains confidential and proprietary information of Pulse Electronics, Inc. (Pulse) and is protected by copyright, trade secret and other state and federal laws. Its receipt or possession does not convey any rights to reproduce, disclose its contents, or to manufacture, use or sell anything it may describe. Reproduction, disclosure or use without specific written authorization of Pulse is strictly forbidden.

Description:
2.5-2.69GHz Ceramic SMT Antenna

Series: Ceramic Chip

PART NUMBER: W3020

PCB Layout

Ground cleared under antenna, clearance area **4.00 x 6.25 mm**

Matching and tuning component value and placement depend on application and surrounding mechanics / materials.

Feed line should be designed to match **50 Ω** characteristic impedance, depending on PWB material and thickness.

Recommended test board layout for electrical characteristic measurement, test board outline size **80 x 37 mm**.

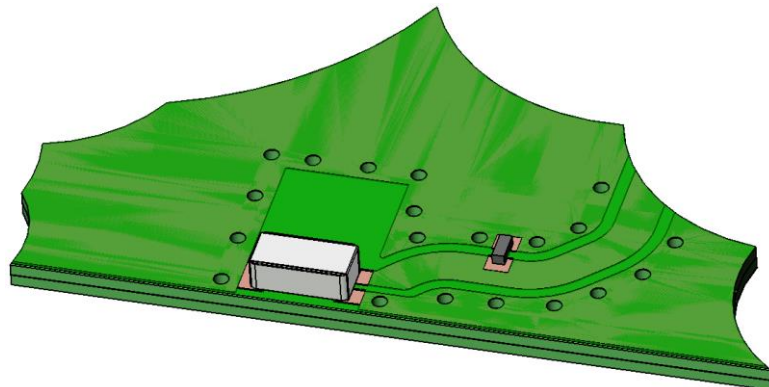
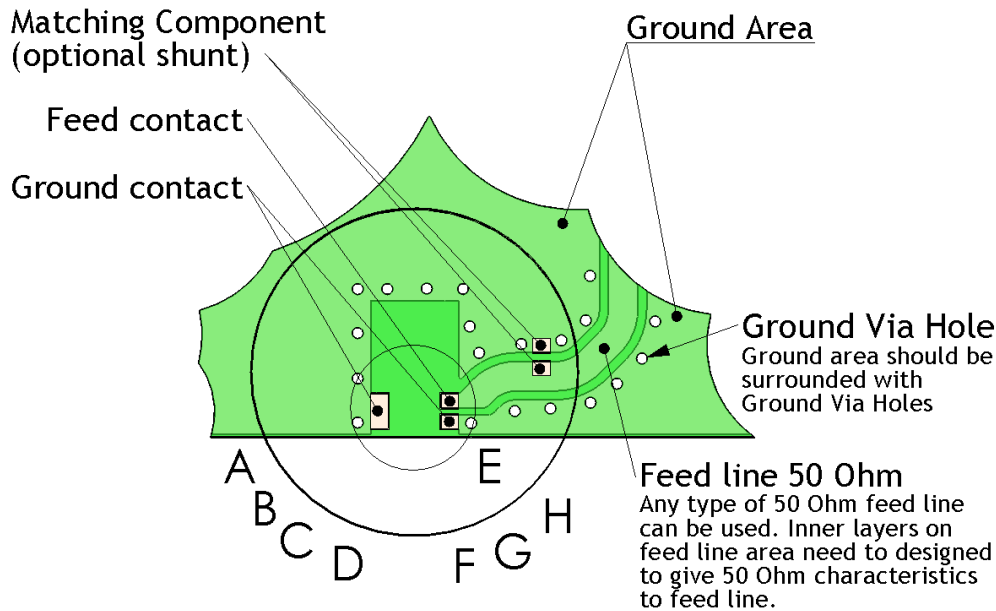

Issue: 1821

In the effort to improve our products, we reserve the right to make changes judged to be necessary.

CONFIDENTIAL AND PROPRIETARY INFORMATION

This document contains confidential and proprietary information of Pulse Electronics, Inc. (Pulse) and is protected by copyright, trade secret and other state and federal laws. Its receipt or possession does not convey any rights to reproduce, disclose its contents, or to manufacture, use or sell anything it may describe. Reproduction, disclosure or use without specific written authorization of Pulse is strictly forbidden.

Description:

2.5-2.69GHz Ceramic SMT Antenna

PART NUMBER: W3020

Series: Ceramic Chip

PCB Layout

Ground clearance area (4,00 x 6,25 mm)

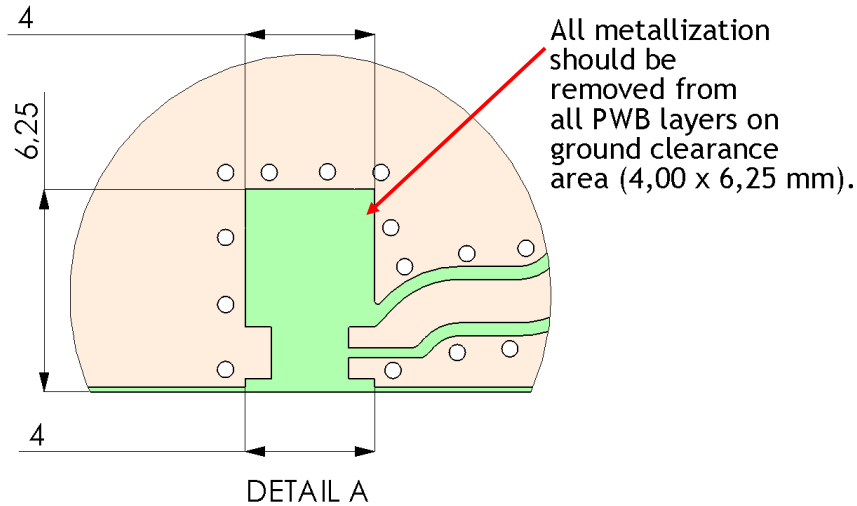

Opening in bottom/inner ground layers

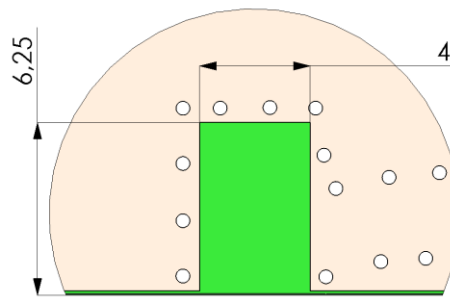

Opening in other layers (no ground/ RF)

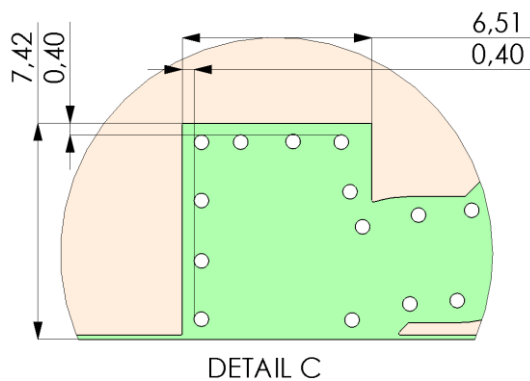

Issue: 1821

In the effort to improve our products, we reserve the right to make changes judged to be necessary.

CONFIDENTIAL AND PROPRIETARY INFORMATION

This document contains confidential and proprietary information of Pulse Electronics, Inc. (Pulse) and is protected by copyright, trade secret and other state and federal laws. Its receipt or possession does not convey any rights to reproduce, disclose its contents, or to manufacture, use or sell anything it may describe. Reproduction, disclosure or use without specific written authorization of Pulse is strictly forbidden.

Description:

2.5-2.69GHz Ceramic SMT Antenna

PART NUMBER: W3020

Series: Ceramic Chip

PCB Layout

Pad dimensions in top copper

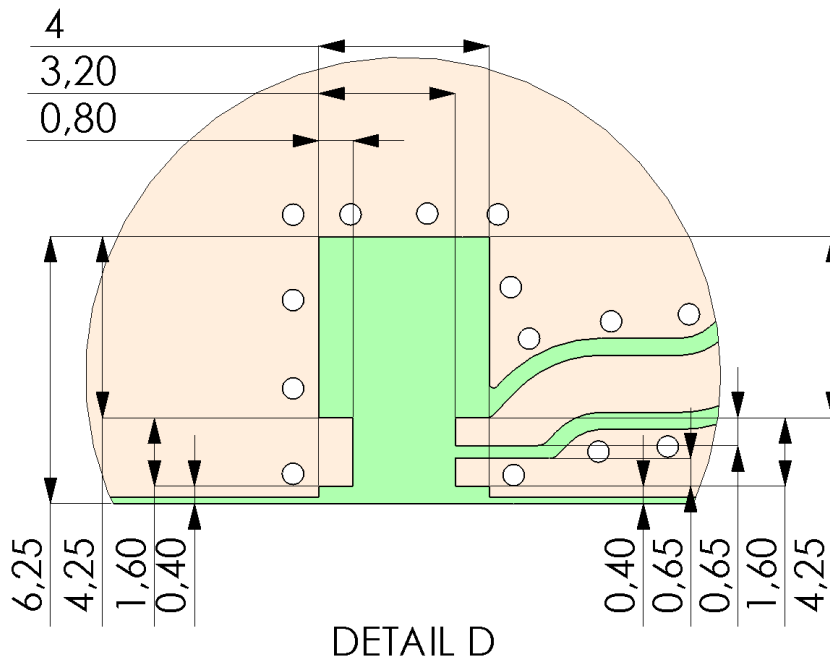

Antenna position on PWB layout

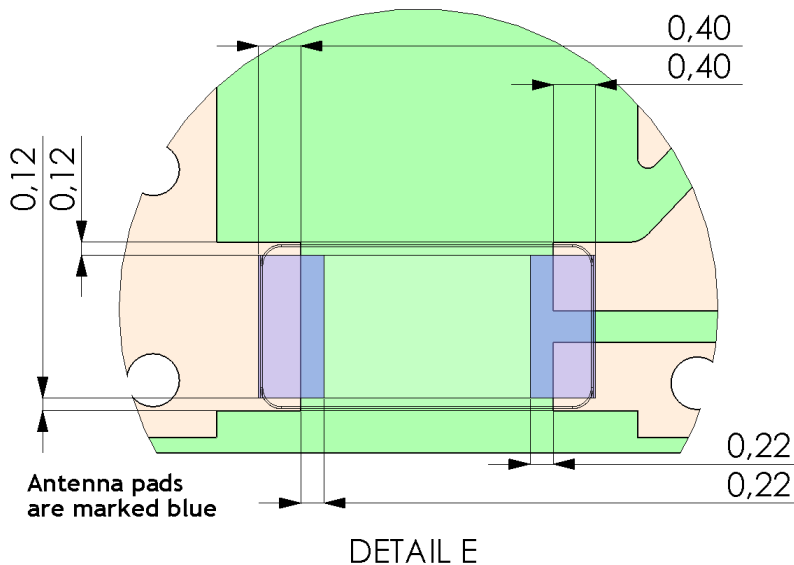

Issue: 1821

In the effort to improve our products, we reserve the right to make changes judged to be necessary.

CONFIDENTIAL AND PROPRIETARY INFORMATION

This document contains confidential and proprietary information of Pulse Electronics, Inc. (Pulse) and is protected by copyright, trade secret and other state and federal laws. Its receipt or possession does not convey any rights to reproduce, disclose its contents, or to manufacture, use or sell anything it may describe. Reproduction, disclosure or use without specific written authorization of Pulse is strictly forbidden.

Description:

2.5-2.69GHz Ceramic SMT Antenna

Series: Ceramic Chip

PART NUMBER: W3020

PCB Layout

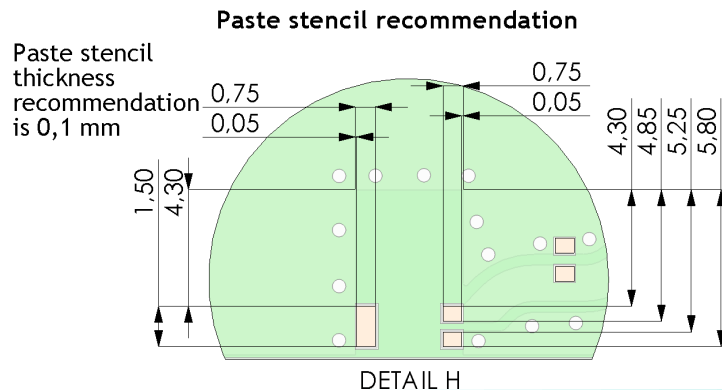
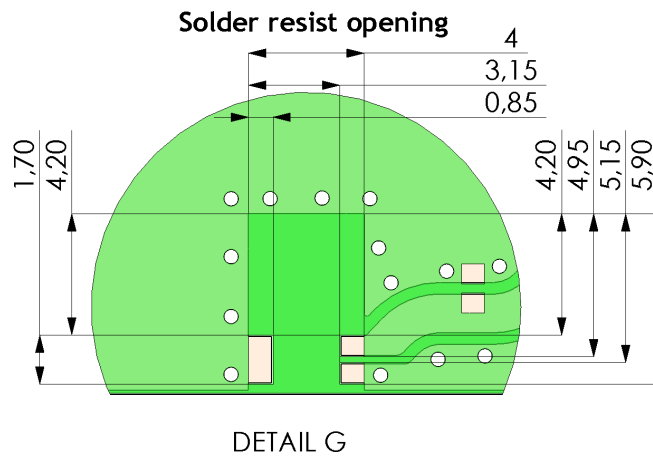
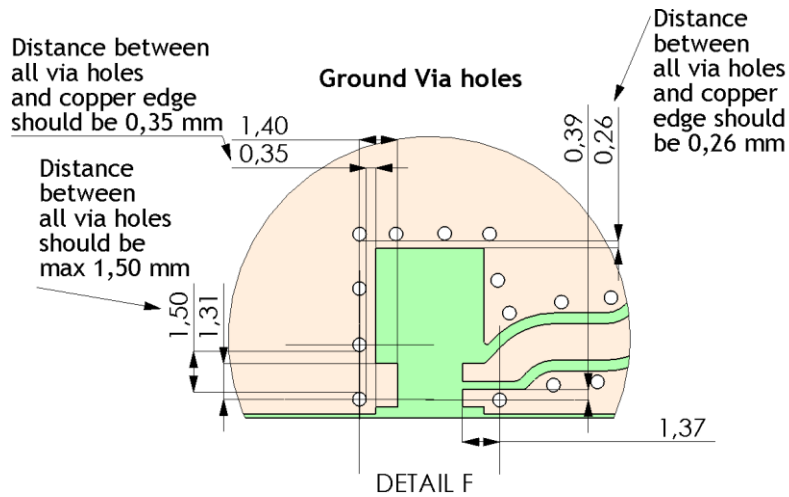

Issue: 1821

In the effort to improve our products, we reserve the right to make changes judged to be necessary.

CONFIDENTIAL AND PROPRIETARY INFORMATION

This document contains confidential and proprietary information of Pulse Electronics, Inc. (Pulse) and is protected by copyright, trade secret and other state and federal laws. Its receipt or possession does not convey any rights to reproduce, disclose its contents, or to manufacture, use or sell anything it may describe. Reproduction, disclosure or use without specific written authorization of Pulse is strictly forbidden.

Series: Ceramic Chip

Description:
2.5-2.69GHz Ceramic SMT Antenna

PART NUMBER: W3020

PCB Layout

Pulse test PWB size is 37 x 80 mm, other sized boards can be used depending on customer device size (minimum 35 x 35 mm)

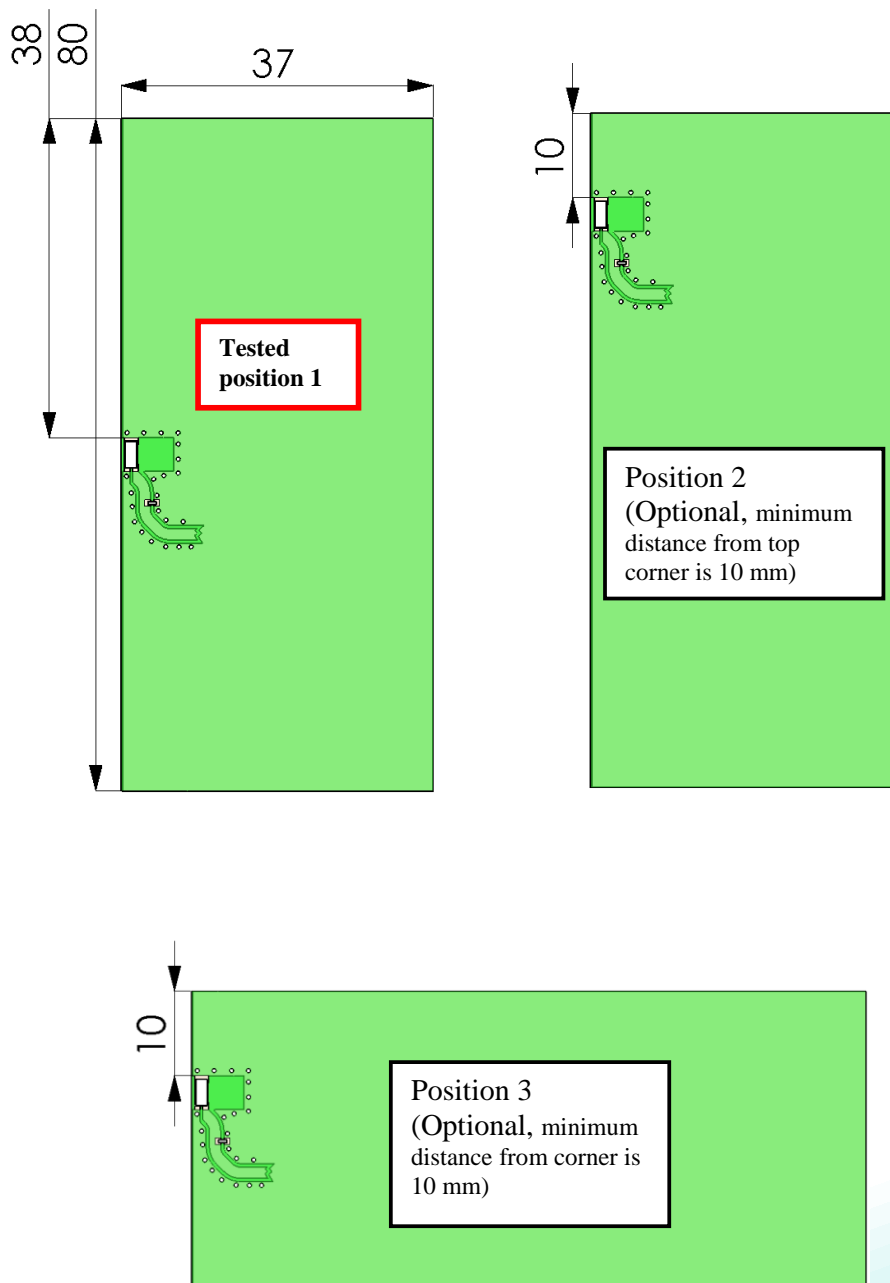

Issue: 1821

In the effort to improve our products, we reserve the right to make changes judged to be necessary.

CONFIDENTIAL AND PROPRIETARY INFORMATION

This document contains confidential and proprietary information of Pulse Electronics, Inc. (Pulse) and is protected by copyright, trade secret and other state and federal laws. Its receipt or possession does not convey any rights to reproduce, disclose its contents, or to manufacture, use or sell anything it may describe. Reproduction, disclosure or use without specific written authorization of Pulse is strictly forbidden.

Description:
2.5-2.69GHz Ceramic SMT Antenna
PART NUMBER: W3020

Series: Ceramic Chip

CHARTS

Ground cleared under antenna, clearance area 4.00 x 6.25 mm

Typical Electrical Characteristics (T=25 °C)

Measured on the 80 x 37mm test board with matching circuit (shunt 1.0 pF) and in antenna position 1 on PWB layout, see page 9.

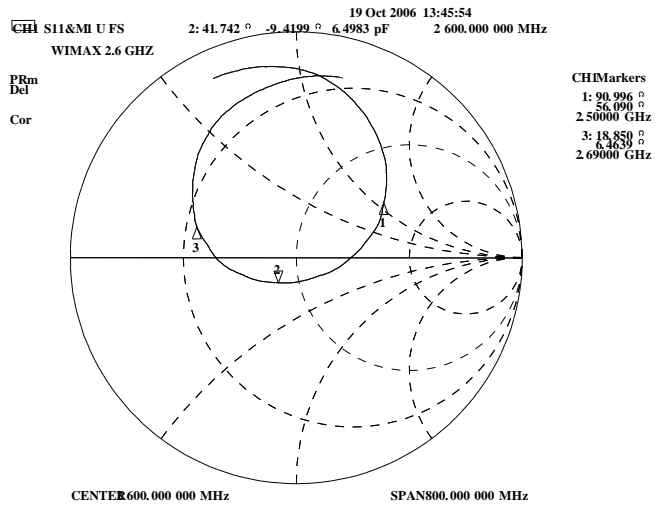
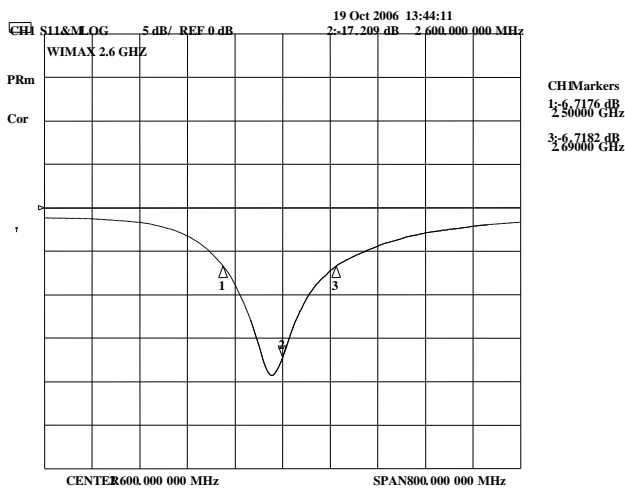

Typical Return Loss S11/ impedance, free space efficiency and gain

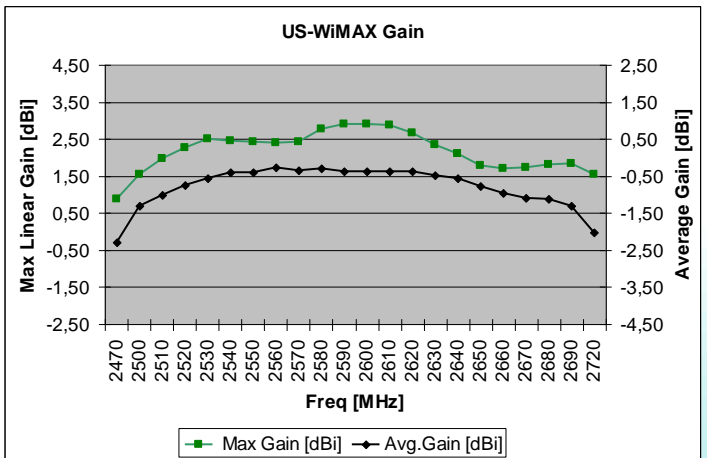
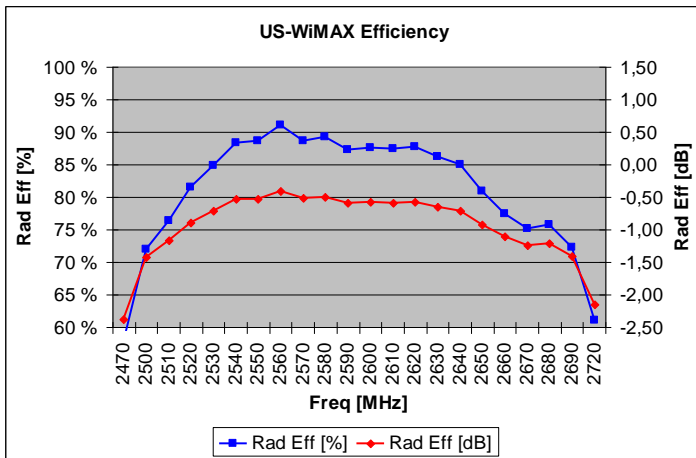

Issue: 1821

In the effort to improve our products, we reserve the right to make changes judged to be necessary.

CONFIDENTIAL AND PROPRIETARY INFORMATION

This document contains confidential and proprietary information of Pulse Electronics, Inc. (Pulse) and is protected by copyright, trade secret and other state and federal laws. Its receipt or possession does not convey any rights to reproduce, disclose its contents, or to manufacture, use or sell anything it may describe. Reproduction, disclosure or use without specific written authorization of Pulse is strictly forbidden.

Description:
2.5-2.69GHz Ceramic SMT Antenna

Series: Ceramic Chip

PART NUMBER: W3020

CHARTS

Typical Free Space Radiation Patterns

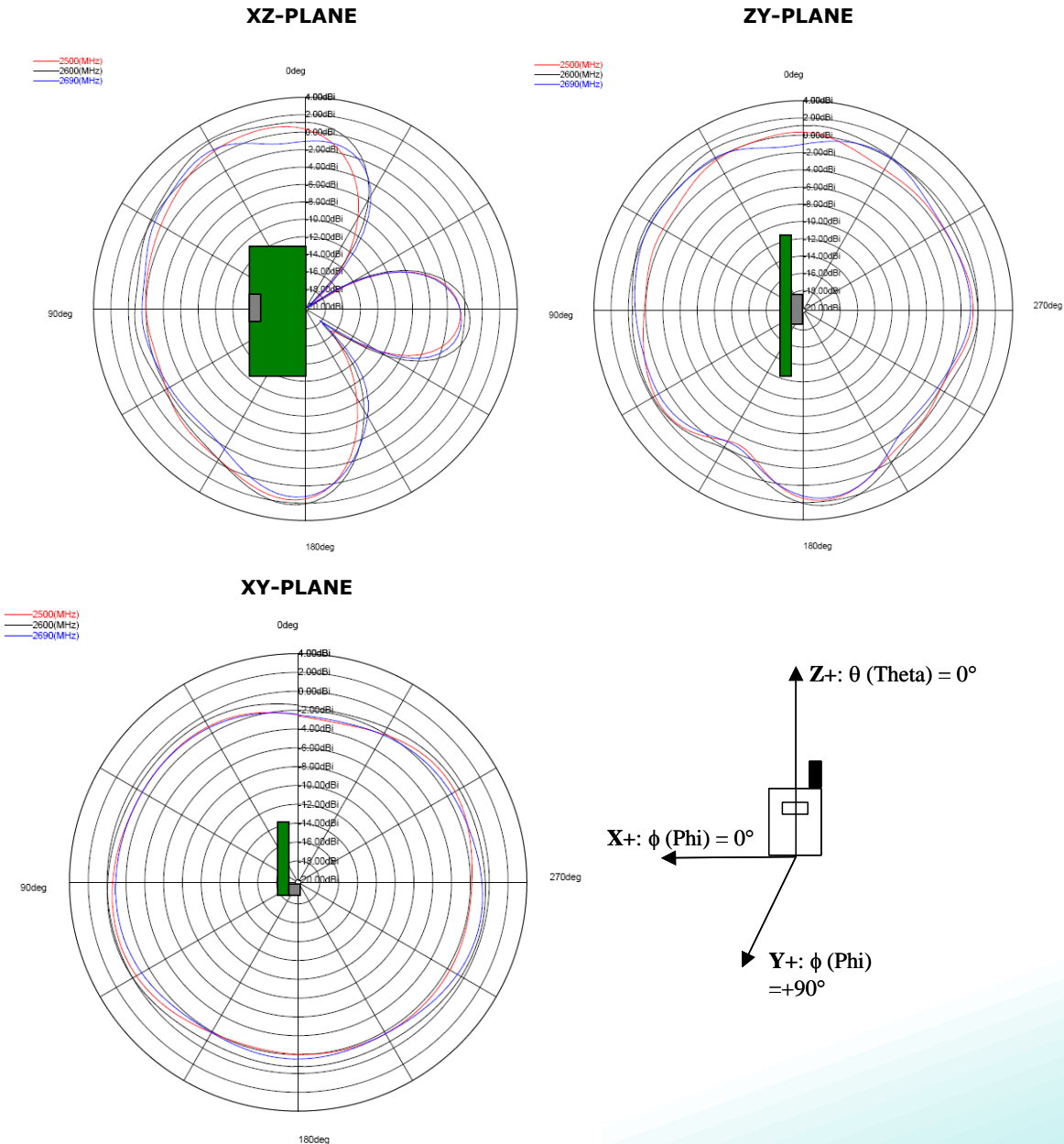

Issue: 1821

In the effort to improve our products, we reserve the right to make changes judged to be necessary.

CONFIDENTIAL AND PROPRIETARY INFORMATION

This document contains confidential and proprietary information of Pulse Electronics, Inc. (Pulse) and is protected by copyright, trade secret and other state and federal laws. Its receipt or possession does not convey any rights to reproduce, disclose its contents, or to manufacture, use or sell anything it may describe. Reproduction, disclosure or use without specific written authorization of Pulse is strictly forbidden.

Description:
2.5-2.69GHz Ceramic SMT Antenna

Series: Ceramic Chip

PART NUMBER: W3020

PACKAGING

- 3000pcs antennas per 7" reel
- 5pcs 7" reel per inner package box
- 2pcs inner box per out box
- Total 30000pcs antenna per out box
- Out box size: 390mmx215mmx165mm

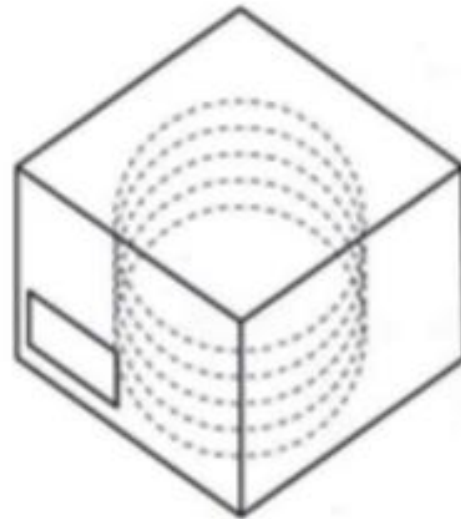
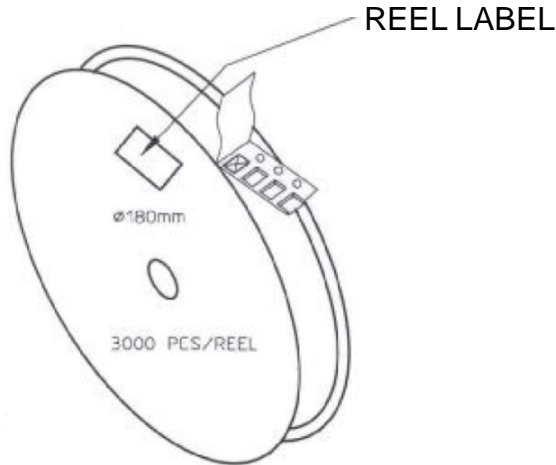

According to MSL3 packing requirement, MBB-Moisture Barrel Bag, Desiccant, HIC-Humidity Indicator Card, MSID Label, Caution Label are required.