

FEATURES

User-programmable temperature setpoint
 $\pm 2.0^{\circ}\text{C}$ maximum ambient setpoint accuracy
 4.1°C typical hysteresis
Wide supply range: 2.7 V to 7.0 V
Wide temperature range: -40°C to $+150^{\circ}\text{C}$
Low power dissipation

APPLICATIONS

Industrial process control
Thermal control systems
CPU monitoring
Computer thermal management circuits
Fan control
Handheld/portable electronic equipment

GENERAL DESCRIPTION

The AD22105 is a solid state thermostatic switch. Requiring only one external programming resistor, the AD22105 can be set to switch accurately at any temperature in the -40°C to $+150^{\circ}\text{C}$ wide operating range. Using a novel circuit architecture, the AD22105 asserts an open-collector output when the ambient temperature exceeds the user-programmed setpoint temperature. The AD22105 has approximately 4°C of hysteresis, which prevents rapid thermal on and off cycling.

The AD22105 operates on a single power supply voltage from 2.7 V to 7.0 V, facilitating operation in battery-powered applications as well as in industrial control systems. Because of low power dissipation ($230\ \mu\text{W}$ at 3.3 V), self heating errors are minimized, and battery life is maximized.

An optional internal 200 k Ω pull-up resistor is included to facilitate driving light loads such as complementary metal-oxide semiconductor (CMOS) inputs.

Alternatively, a low power light emitting diode (LED) indicator can be driven directly.

FUNCTIONAL BLOCK DIAGRAM

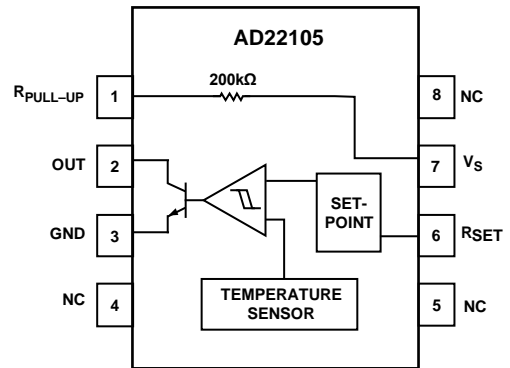

Figure 1.

02089-001

TABLE OF CONTENTS

| | | | |
|---|---|---|----|
| Features | 1 | Effect of Resistor Tolerance and Thermal Drift on Setpoint Accuracy | 8 |
| Applications | 1 | Hysteresis and Self Heating | 9 |
| General Description | 1 | Output Section | 9 |
| Functional Block Diagram | 1 | Mounting Considerations | 9 |
| Revision History | 2 | Thermal Environment Effects | 9 |
| Specifications | 3 | Using the AD22105 as a Cooling Setpoint Detector | 9 |
| Absolute Maximum Ratings | 4 | Applications Information | 10 |
| Thermal Resistance | 4 | Electromagnetic Interference (EMI) Suppression | 10 |
| ESD Caution | 4 | Leakage at the R _{SET} Pin | 10 |
| Pin Configuration and Function Descriptions | 5 | Outline Dimensions | 11 |
| Typical Performance Characteristics | 6 | Ordering Guide | 11 |
| Theory of Operation | 8 | | |
| The Setpoint Resistor | 8 | | |

REVISION HISTORY

10/2018—Rev. 0 to Rev. A

| | |
|--|-----------|
| Update Format | Universal |
| Changes to Features Section | 1 |
| Changed Product Description Section to Theory of Operation Section | 8 |
| Changed Application Hint Section to Applications Information Section | 10 |
| Updated Outline Dimensions | 11 |
| Changes to Ordering Guide | 11 |

1/1996—Revision 0: Initial Version

SPECIFICATIONS

Supply voltage (V_S) = 3.3 V, T_A = 25°C, and load resistor (R_{LOAD}) = internal 200 kΩ, unless otherwise noted.

Table 1.

| Parameter | Symbol | Test Conditions/Comments | Min | Typ | Max | Unit |
|-------------------------------|------------------|------------------------------------|-----|-------|-------|------|
| TEMPERATURE ACCURACY | | | | | | |
| Ambient Setpoint Accuracy | ACC | | | ±0.5 | ±2.0 | °C |
| Temperature Setpoint Accuracy | ACC _T | -40°C ≤ T_A ≤ +125°C | | | ±3.0 | °C |
| Power Supply Rejection | PSR | 2.7 V ¹ < V_S < 7.0 V | | ±0.05 | ±0.15 | °C/V |
| HYSTERESIS | HYS | | | 4.1 | | °C |
| OPEN-COLLECTOR OUTPUT | | | | | | |
| Output Low Voltage | V_{OL} | Sink current (I_{SINK}) = 5 mA | | 250 | 400 | mV |
| POWER SUPPLY | | | | | | |
| Supply Voltage Range | V_S | | 2.7 | | 7.0 | V |
| Supply Current | | | | | | |
| Output Low | I_{SON} | | | | 120 | μA |
| Output High | I_{SOFF} | | | | 90 | μA |
| INTERNAL PULL-UP RESISTOR | $R_{PULL-UP}$ | | 140 | 200 | 260 | kΩ |
| TURN-ON SETTLING TIME | t_{ON} | | | 5 | | μs |

¹ The AD22105 operates at voltages as low as 2.2 V.

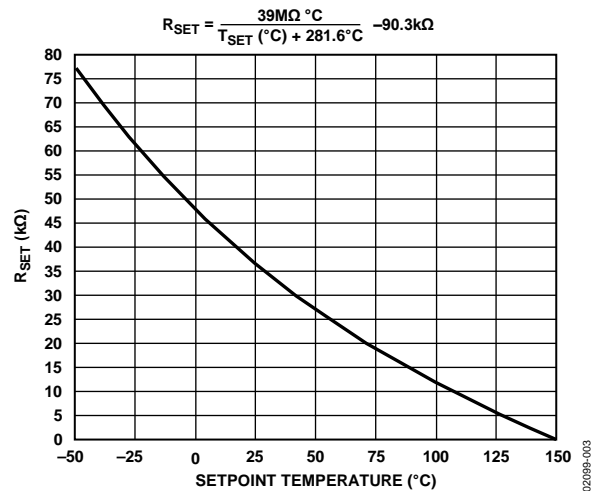

Figure 2. Setpoint Resistor Values

ABSOLUTE MAXIMUM RATINGS

Table 2.

| Parameter | Ratings |
|--|-----------------|
| Maximum Supply Voltage | 11 V |
| Maximum Output Voltage (R _{PULL-UP}) | 11 V |
| Maximum Output Current (OUT) | 10 mA |
| Operating Temperature Range | -40°C to +150°C |
| Dice Junction Temperature | 160°C |
| Storage Temperature Range | -65°C to +160°C |
| Lead Temperature (Soldering, 10 sec) | 300°C |

Stresses at or above those listed under Absolute Maximum Ratings may cause permanent damage to the product. This is a stress rating only; functional operation of the product at these or any other conditions above those indicated in the operational section of this specification is not implied. Operation beyond the maximum operating conditions for extended periods may affect product reliability.

THERMAL RESISTANCE

Thermal performance is directly linked to PCB design and operating environment. Careful attention to PCB thermal design is required.

Table 3. Thermal Resistance

| Package | θ_{JA} (°C/W) | τ (sec) ¹ |
|---|----------------------|---------------------------|
| SOIC_N (R-8) | | |
| Moving Air Without Heat Sink ² | 100 | 3.5 |
| Still Air Without Heat Sink | 190 | 15 |

¹ The time constant is defined as the time to reach 63.2% of the final temperature change.

² 1200 cubic feet per minute (CFM)

ESD CAUTION



ESD (electrostatic discharge) sensitive device. Charged devices and circuit boards can discharge without detection. Although this product features patented or proprietary protection circuitry, damage may occur on devices subjected to high energy ESD. Therefore, proper ESD precautions should be taken to avoid performance degradation or loss of functionality.

PIN CONFIGURATION AND FUNCTION DESCRIPTIONS



Figure 3. Pin Configuration

Table 4. Pin Function Descriptions

| Pin No. | Mnemonic | Description |
|---------|---------------|--|
| 1 | $R_{PULL-UP}$ | Internal 200 k Ω Pull-Up Resistor (Optional). |
| 2 | OUT | Device Output. |
| 3 | GND | Ground. |
| 4, 5, 8 | NC | No Connect. |
| 6 | R_{SET} | Temperature Setpoint Resistor. |
| 7 | V_S | Supply Voltage. V_S must be between 2.7 V and 7.0 V. |

TYPICAL PERFORMANCE CHARACTERISTICS

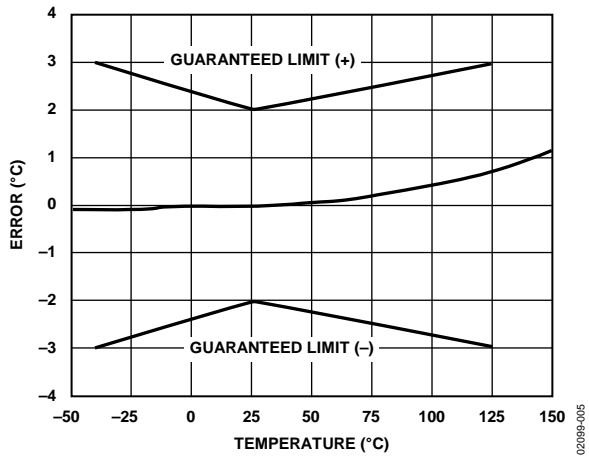

Figure 4. Error vs. Temperature, Setpoint

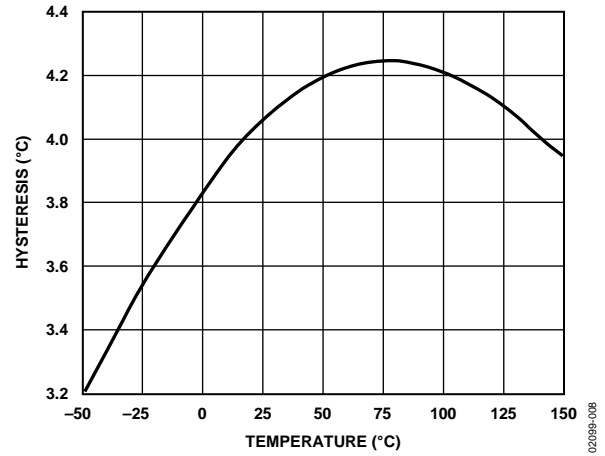

Figure 7. Hysteresis vs. Temperature, Setpoint



Figure 5. Setpoint Error vs. Temperature Due to R_{SET} Tolerance

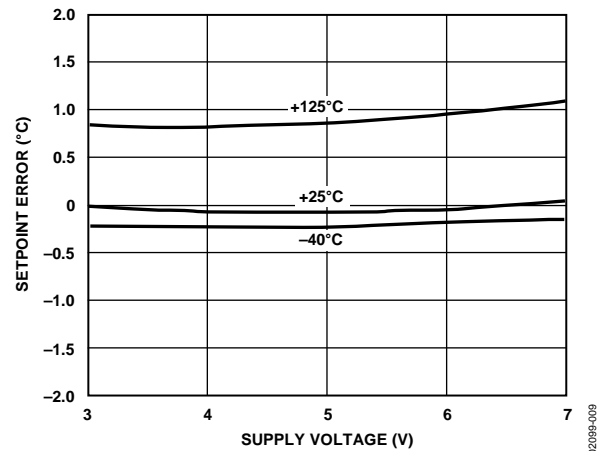

Figure 8. Setpoint Error vs. Supply Voltage for Various Temperatures

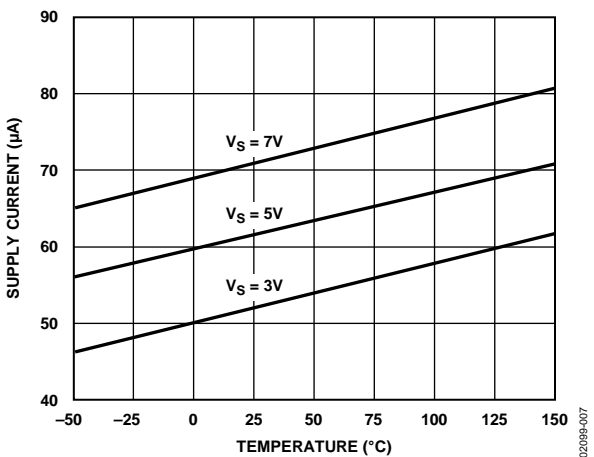

Figure 6. Supply Current (V_S) vs. Temperature, Output Voltage (V_{OUT}) = High

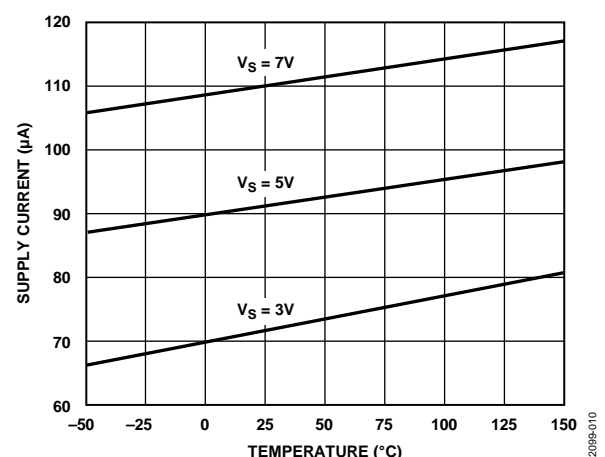

Figure 9. Supply Current vs. Temperature, V_{OUT} = Low

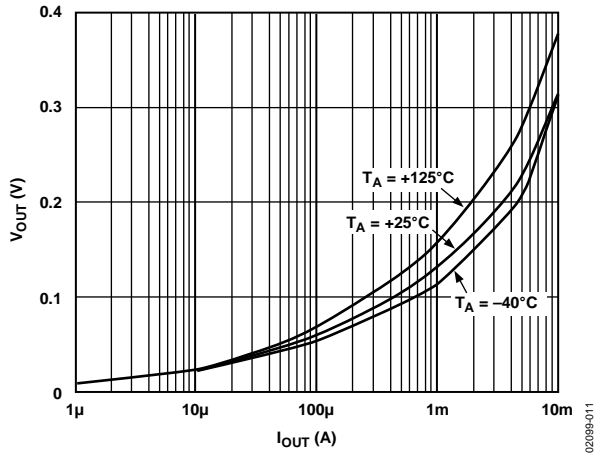

Figure 10. V_{out} vs. Output Current (I_{out}), $V_{out} = Low$

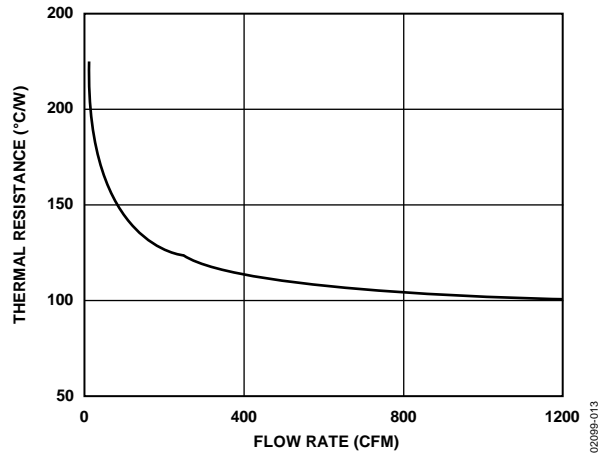

Figure 12. Thermal Resistance (θ_{JA}) vs. Flow Rate

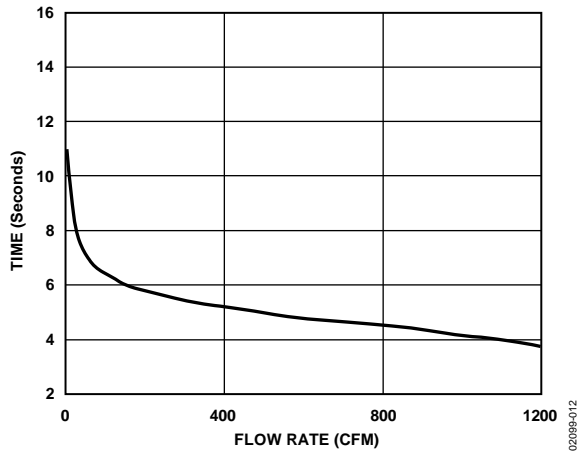

Figure 11. Time vs. Flow Rate, Thermal Response

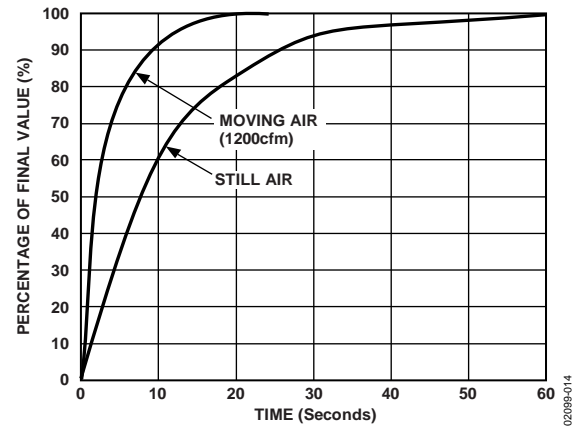

Figure 13. Percentage of Final Value vs. Time, Thermal Response Time

THEORY OF OPERATION

The AD22105 is a single-supply semiconductor thermostat switch that uses a circuit architecture to realize the combined functions of a temperature sensor, setpoint comparator, and output stage all in one IC. By using one external resistor, the AD22105 can be programmed to switch at any temperature selected by the system designer in the -40°C to $+150^{\circ}\text{C}$ range. The internal comparator is designed to switch accurately as the ambient temperature rises past the setpoint temperature. When the ambient temperature falls, the comparator relaxes its output at a somewhat lower temperature than that at which the comparator originally switched. The difference between the switch and unswitched temperatures, known as the hysteresis, is nominally 4°C .

THE SETPOINT RESISTOR

Determine the setpoint resistor by the following equation:

$$R_{SET} = \frac{39 \text{ M}\Omega \text{ }^{\circ}\text{C}}{T_{SET} (^{\circ}\text{C}) + 281.6^{\circ}\text{C}} - 90.3 \text{ k}\Omega \quad (1)$$

Connect the setpoint resistor directly between the R_{SET} pin and the GND pin. If a ground plane is used, connect the resistor directly to this plane at the closest available point.

The setpoint resistor, R_{SET} , can be almost any resistor type. However, the resistor initial tolerance and thermal drift affects the accuracy of the programmed switching temperature. For most applications, a 1% metal film resistor provides the best tradeoff between cost and accuracy. Calculations for computing an error budget are found in the Effect of Resistor Tolerance and Thermal Drift on Setpoint Accuracy section.

After R_{SET} is calculated, the calculated value does not agree with readily available standard resistors of the chosen tolerance. To achieve an R_{SET} value as close as possible to the calculated value, a compound resistor can be constructed by connecting two resistors in series or in parallel. To conserve cost, one moderately precise resistor and one lower precision resistor can be combined. If the moderately precise resistor provides most of the necessary resistance, the lower precision resistor can provide a fine adjustment. Consider an example where the closest standard 1% resistor has only 90% of the value required for R_{SET} . If a 5% series resistor is used for the remainder, the tolerance of the resistor only adds 5% of 10% or 0.5% additional error to the combination. Likewise, the 1% resistor only contributes 90% of 1% or 0.9% error to the combination. These two contributions are additive, resulting in a total compound resistor tolerance of 1.4%.

EFFECT OF RESISTOR TOLERANCE AND THERMAL DRIFT ON SETPOINT ACCURACY

Figure 4 shows the typical accuracy error in setpoint temperature as a function of the programmed setpoint temperature. This curve assumes an ideal resistor for R_{SET} . Figure 5 can be used to calculate additional setpoint error as a function of resistor tolerance. Figure 5 shows additional error beyond the initial accuracy error of the device and must be added to the value found in Table 1. For example, consider using the AD22105 programmed to switch at 125°C . Figure 5 indicates that at $+125^{\circ}\text{C}$, the additional error is approximately $-0.2^{\circ}\text{C}/\%$ of R_{SET} . If a 1% resistor (of exactly correct value) is chosen, the additional error is $-0.2^{\circ}\text{C}/\% \times 1\%$ or -0.2°C . If the closest standard resistor value is 0.6% away from the calculated value, the total error is 0.6% for the nominal value and 1% for the tolerance or 1.006×1.01 or 1.01606 (about 1.6%). The closest resistor value differing slightly from the calculated value can lead to an additional setpoint error as high as 0.32°C .

For additional accuracy considerations, take the thermal drift of the setpoint resistor into account. For example, consider that the drift of the metal film resistor is $100 \text{ ppm}/^{\circ}\text{C}$. Because this drift is usually referred to 25°C , the setpoint resistor can be in error by an additional $100 \text{ ppm}/^{\circ}\text{C} \times (125^{\circ}\text{C} - 25^{\circ}\text{C})$ or 1%. Using a setpoint temperature of 125°C , this error source adds an additional -0.2°C (for positive drift) making the overall setpoint error potentially -0.52°C higher than the original accuracy error.

To combine and calculate the initial tolerance and thermal drift effects of the setpoint resistor use the following equation:

$$R_{MAX} = R_{NOM} \times (1 + \epsilon) \times (1 + T_C \times (T_{SET} - 25^{\circ}\text{C}))$$

where:

R_{MAX} is the worst case value that the setpoint resistor can be at T_{SET} .
 R_{NOM} is the standard resistor with a value closest to the desired R_{SET} .
 ϵ is the 25°C tolerance of the chosen resistor (usually 1%, 5%, or 10%).

T_C is the temperature coefficient of the available resistor.
 T_{SET} is the desired setpoint temperature.

After calculation, compare R_{MAX} to the desired R_{SET} from Equation 1. The required value of R_{SET} at a T_{SET} of 125°C is $5.566 \text{ k}\Omega$. If the nearest standard resistor value is $5.600 \text{ k}\Omega$, its worst case maximum value at $+125^{\circ}\text{C}$ is $5.713 \text{ k}\Omega$, which is $+2.6\%$ higher than R_{SET} , leading to a total additional error of -0.52°C beyond that given in Table 1.

HYSTERESIS AND SELF HEATING

The actual value of hysteresis generally has a minor dependence on the programmed setpoint temperature, as shown in Figure 7. Furthermore, the hysteresis can be affected by self heating if the device is driving a heavy load. For example, if the device is driving a load of 5 mA at an output voltage (given by Figure 10) of 250 mV, the additional power dissipation is approximately 1.25 mW. With a θ_{JA} of 190°C/W in still air, the internal die temperature is 0.24°C higher than ambient, leading to an increase of 0.24°C in hysteresis. In the presence of a heat sink or a turbulent environment, the additional hysteresis is less.

OUTPUT SECTION

The output of the AD22105 is the collector of the negative positive negative (NPN) transistor. When the ambient temperature of the device exceeds the programmed setpoint temperature, this transistor is activated, causing its collector to become a low impedance. A pull-up resistor, such as the internal 200 k Ω provided, is needed to observe a change in the output voltage. For versatility, the optional pull-up resistor is not permanently connected to the output pin. Instead, this resistor is undedicated and connects from the V_S pin to the $R_{PULL-UP}$ pin. To use $R_{PULL-UP}$, a single connection must be made from the $R_{PULL-UP}$ pin to the OUT pin.

The 200 k Ω pull-up resistor can drive CMOS loads because essentially no static current is required at these inputs. When driving low power Schottky (LS) and other bipolar family logic inputs, a parallel resistor may be necessary to supply the 20 μ A to 50 μ A high level input current (I_{IH}) specified for such devices. To determine the current required, consult the appropriate manufacturer data sheet. When the output is switched, indicating an over temperature condition, the output is capable of pulling down with 10 mA at a voltage of about 375 mV, which allows a fanout of 2 with standard bipolar logic and 20 with LS family logic.

Low power indicator LEDs (up to 10 mA) can be driven directly from the output pin of the AD22105. In most cases, a small series resistor (usually of several hundred ohms) is required to limit the current to the LED and the output transistor of the AD22105.

MOUNTING CONSIDERATIONS

If the AD22105 is thermally attached and properly protected, it can be used in any measuring situation where the maximum range of temperatures encountered is between -40°C and +150°C. Because plastic IC packaging technology is employed, excessive mechanical stress must be avoided when fastening the device with a clamp or screw on the heat tab. Thermally conductive epoxy or glue is recommended for typical mounting conditions. In wet or corrosive environments, use an electrically isolated metal or ceramic well to protect the AD22105.

THERMAL ENVIRONMENT EFFECTS

The thermal environment in which the AD22105 is used determines two performance traits: the effect of self heating on accuracy and the response time of the sensor to rapid changes in temperature. In the first case, a rise in the IC junction temperature above the ambient temperature is a function of two variables: the power consumption of the AD22105 and the thermal resistance between the chip and the ambient environment, θ_{JA} . Self heating error can be derived by multiplying the power dissipation by θ_{JA} . Because errors of this type can vary widely for surroundings with different heat sinking capacities, it is necessary to specify θ_{JA} under several conditions.

Table 3 shows how the magnitude of self heating error varies relative to the environment. A typical device dissipates about 230 μ W at room temperature with a 3.3 V supply and negligible output loading. In still air, without a heat sink, Table 3 indicates a θ_{JA} of 190°C/W, which yields a temperature rise of 0.04°C. Thermal rise of the die is considerably less in an environment of turbulent or constant moving air or if the device is in direct physical contact with a solid (or liquid) body.

Response of the AD22105 internal die temperature to abrupt changes in ambient temperatures can be modeled by a single time constant exponential function. Figure 12 shows the typical response for moving and still air. The time constant, τ (time to reach 63.2% of the final value), is dependent on θ_{JA} and the thermal capacities of the chip and the package.

Table 3 lists the effective τ for moving and still air. Copper PCB connections were neglected in the analysis. However, these connections sink or conduct heat directly through the AD22105 solder plated copper leads. When faster response is required, use a thermally conductive grease or glue between the AD22105 and the surface temperature being measured.

USING THE AD22105 AS A COOLING SETPOINT DETECTOR

The AD22105 detects transitions from higher temperatures to lower temperatures by programming the setpoint temperature 4°C greater than the desired trip point temperature. The 4°C is necessary to compensate for the nominal hysteresis value designed into the device. A more precise value of the hysteresis can be obtained from Figure 7. In this mode, the logic state of the output indicates a high for under temperature conditions. The total device error is slightly greater than the specification value due to the uncertainty in hysteresis.

APPLICATIONS INFORMATION

Figure 14 shows the typical application circuit.



Figure 14. Typical Application Circuit

ELECTROMAGNETIC INTERFERENCE (EMI) SUPPRESSION

Noisy environments may couple electromagnetic energy into the R_{SET} node causing the AD22105 to falsely trip or untrip. Noise sources, which typically come from fast rising edges, can be coupled into the device capacitively. Furthermore, if the output signal is close to the R_{SET} pin, energy can couple from the OUT pin to the R_{SET} pin, potentially causing oscillation. Stray capacitance can come from several places such as IC sockets, multiconductor cables, and PCB traces. In some cases, constructing a Faraday shield around the R_{SET} pin can correct this; for example, by using a shielded cable with the shield grounded. However, for best performance, avoid cables and directly solder the AD22105 to a PCB whenever possible. Figure 15 shows a sample PCB layout with low inter pin capacitance and Faraday shielding. If stray capacitance is unavoidable, and interference or oscillation occurs, connect a low impedance capacitor from the R_{SET} pin to the GND pin. This capacitor must be considerably larger than the estimated stray capacitance. Typically, several hundred picofarads corrects the problem.

LEAKAGE AT THE R_{SET} PIN

Leakage currents at the R_{SET} pin, such as those generated from a moist environment or PCB contamination, can have an adverse effect on the programmed setpoint temperature of the AD22105. Depending on the leakage source, leakage current can flow into or out of the R_{SET} pin. Consequently, the actual setpoint temperature may be higher or lower than the intended setpoint temperature by about 1°C for each 75 nA of leakage. With a 5 V power supply, an isolation resistance of 100 M Ω creates 50 nA of leakage current, resulting in a setpoint temperature error of about 0.7°C (the R_{SET} pin is near ground potential). Place a guard ring around the R_{SET} node to protect against leakage from the power supply pin (as shown in Figure 15).



Figure 15. Suggested PCB Layout

OUTLINE DIMENSIONS

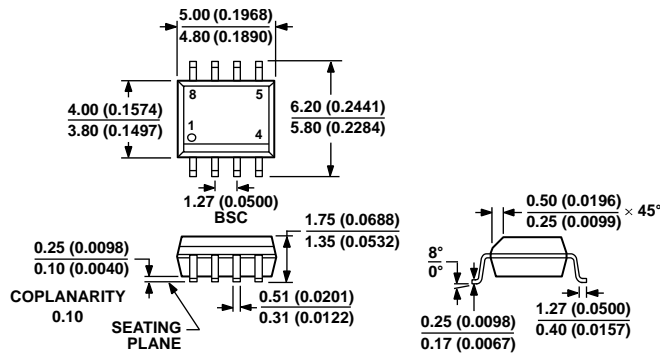

COMPLIANT TO JEDEC STANDARDS MS-012-AA
 CONTROLLING DIMENSIONS ARE IN MILLIMETERS; INCH DIMENSIONS
 (IN PARENTHESES) ARE ROUNDED-OFF MILLIMETER EQUIVALENTS FOR
 REFERENCE ONLY AND ARE NOT APPROPRIATE FOR USE IN DESIGN.

012407-A

Figure 16. 8-Lead Standard Small Outline Package [SOIC_N]
 Narrow Body
 (R-8)

Dimensions shown in millimeters and (inches)

ORDERING GUIDE

| Model ¹ | Temperature Range | Package Description | Package Option |
|--------------------|-------------------|--|----------------|
| AD22105ARZ | -40°C to +150°C | 8-Lead Standard Small Outline Package [SOIC_N] | R-8 |
| AD22105ARZ-REEL | -40°C to +150°C | 8-Lead Standard Small Outline Package [SOIC_N] | R-8 |
| AD22105ARZ-REEL7 | -40°C to +150°C | 8-Lead Standard Small Outline Package [SOIC_N] | R-8 |

¹ Z = RoHS Compliant Part.