

# Z-PACK SLIM UHD

## Backplane Connector



Accommodating a broad spectrum of speeds up to 20 Gbps, TE's Z-PACK Slim UHD backplane connector lets you design for today's speed while planning for tomorrow's. Designed to be the densest connector in the smallest possible footprint, the connector frees up PCB space, giving you more room to design for performance. Through a highly configurable design, the Z-PACK Slim UHD connector offers the flexibility needed to design intricate communication systems.

- **Speed Scalability and Configurability:** The Z-PACK Slim UHD connector transfers data at 12.5 Gbps, with scalability up to 20 Gbps, allowing you to efficiently increase your communication system's speed without modifying the existing PCB footprint.
- **Space Savings:** Owing to its small size, which is about 10% smaller than similar products on the market, the product fits into tight 15mm (0.6 inch) slot pitch applications, offering significant PCB space savings.
- **Design Flexibility:** Through a highly configurable design, multiple pin assignments can be achieved.

## Applications

- Switches
- Routers
- Servers
- Other telecommunication equipment

## Design Flexibility - Pin Assignments

- Below are examples of the various connector pin assignments available:
  - 1.5 differential pairs per column
  - 2.0 differential pairs per column
  - Extremely high density in a fully single-ended arrangement up to 55 signal lines/cm<sup>2</sup>

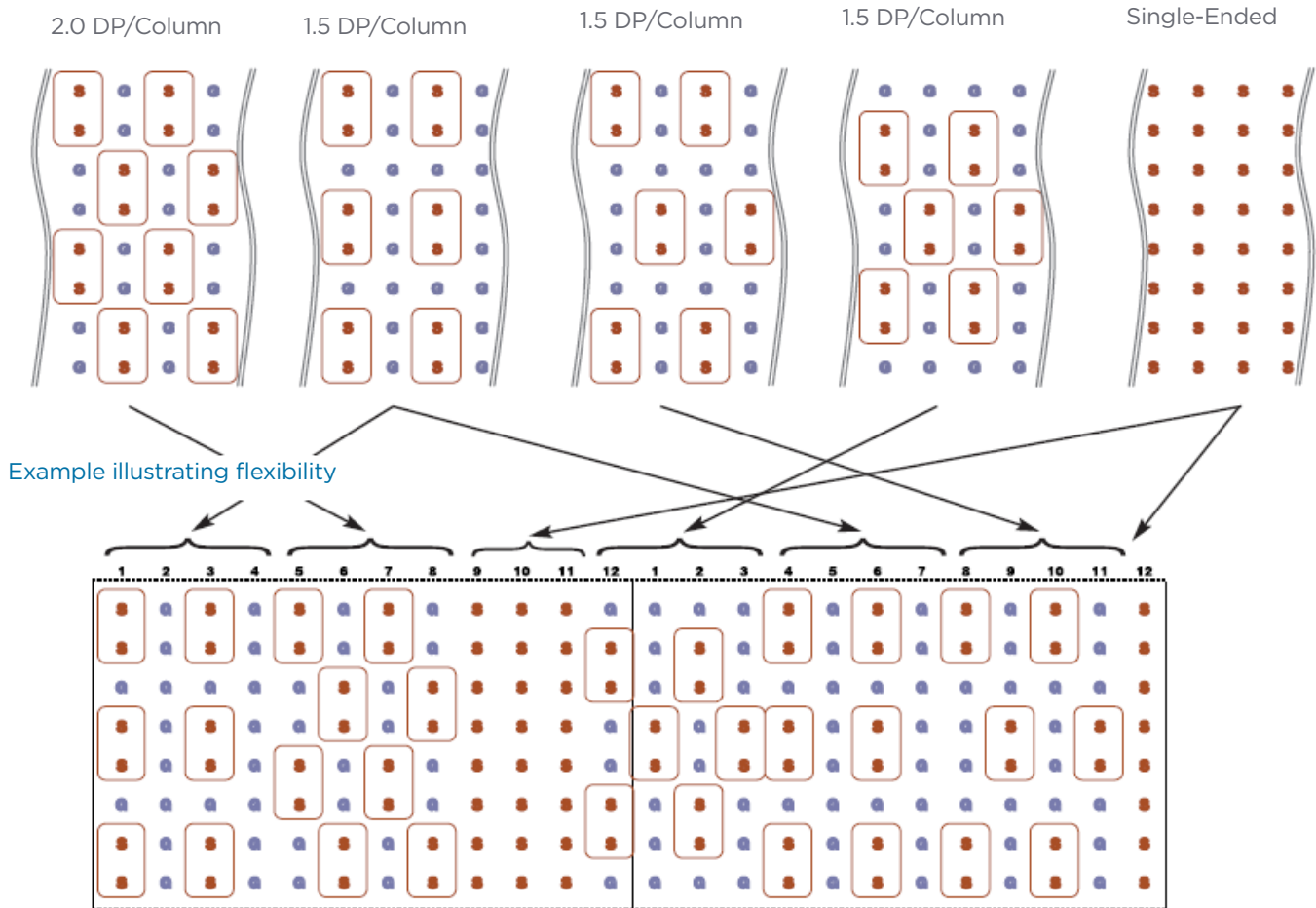

For more pin assignments, please refer to application specification 114-19106 (high speed) or 114-19112 (common speed). You can also contact TE.

## Speed Scalability

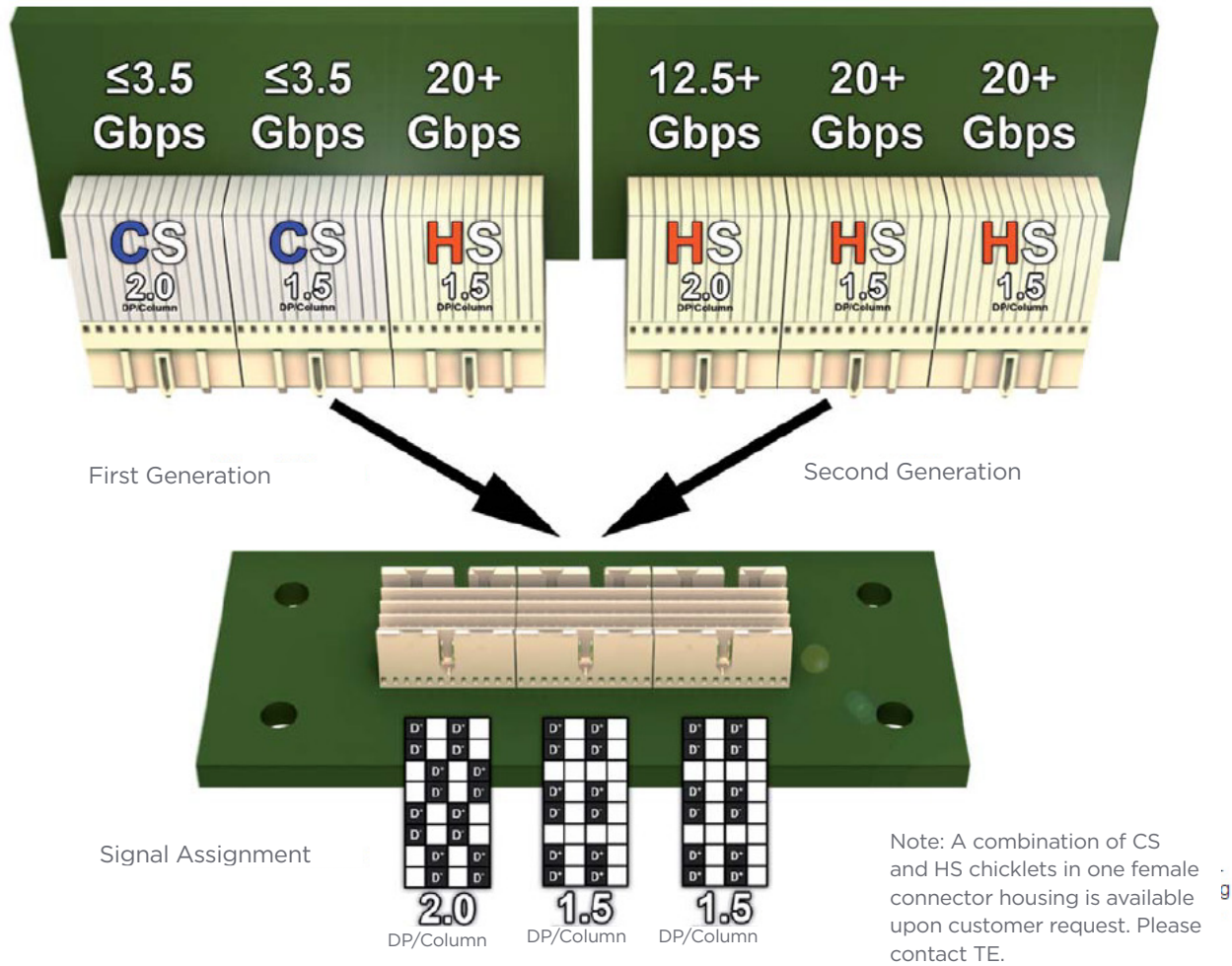

## Space Savings

Drill Size: 0.5 mm  
 Finished Hole Size: 0.4 mm  
 Pad Size: 0.8 mm  
 Anti-Pad Size: 0.95 mm

- Identical board footprints on backplane and daughter-card
- 1.45 mm routing channels available in horizontal and vertical direction
- Footprint allows 4-6-4 MIL or 5-7-5 MIL differential routing

System and connector evaluation boards are available upon request.

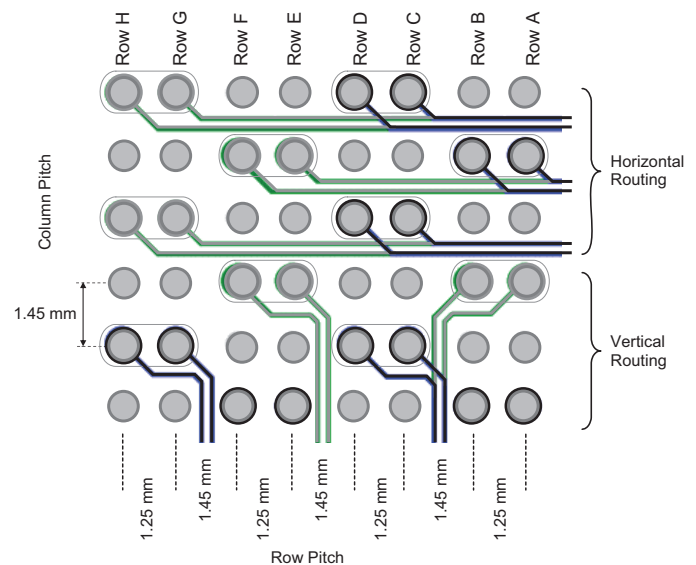

## Typical Electric Properties

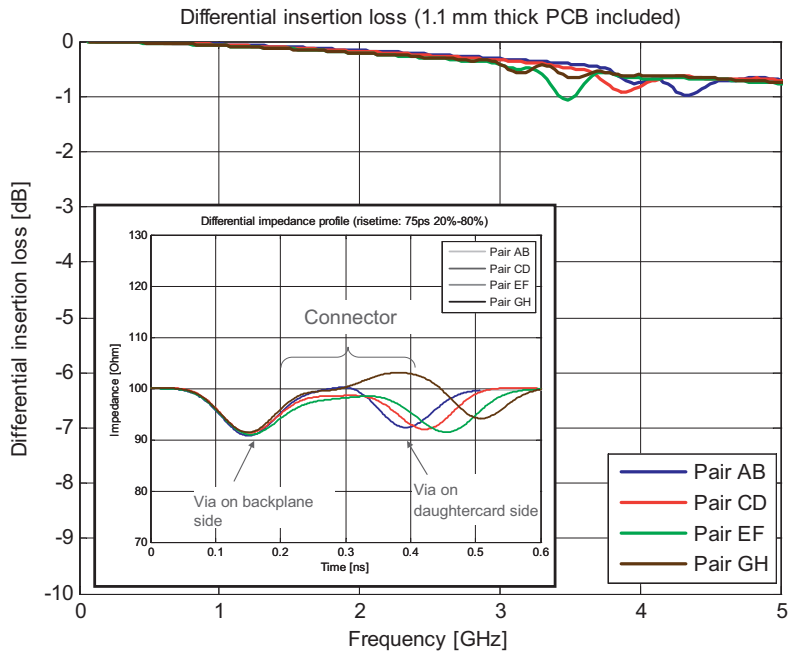

### 2.0 DP/Column Common Speed\*

Worst Case Noise with recommended TX/RX pinout:  
2.1% @ 75 ps (20% to 80%)

Noise Summary	Total Asynchronous Noise @ 75 ps Risetime (20% to 80%)	
	2.0 different pairs/column	
Victim Pair	Total Async. NEXT	Total Async. FEXT
Pair AB	1.4 %	0.7 %
Pair CD	2.9 %	1.1 %
Pair EF	2.9 %	1.2 %
Pair GH	1.4 %	0.7 %

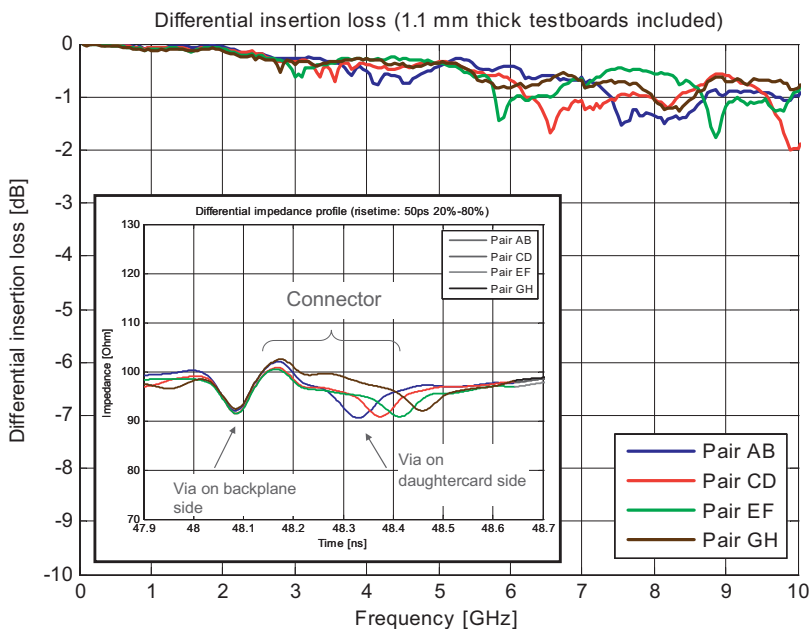

### 2.0 DP/Column High Speed\*\*

Worst Case Noise with recommended TX/RX pinout:  
1.9 % @ 50 ps (20% to 80%)

Noise Summary	Total Asynchronous Noise @ 50 ps Risetime (20% to 80%)	
	2.0 different pairs/column	
Victim Pair	Total Async. NEXT	Total Async. FEXT
Pair AB	1.5 %	0.6 %
Pair CD	3.1 %	1.3 %
Pair EF	3.1 %	1.5 %
Pair GH	1.5 %	0.8 %

\* All simulation data include the footprint performance of a 1.1mm thick PCB test-board.

\*\* All measurement data include the footprint performance of a 1.1mm thick PCB test-board.

## Typical Electric Properties

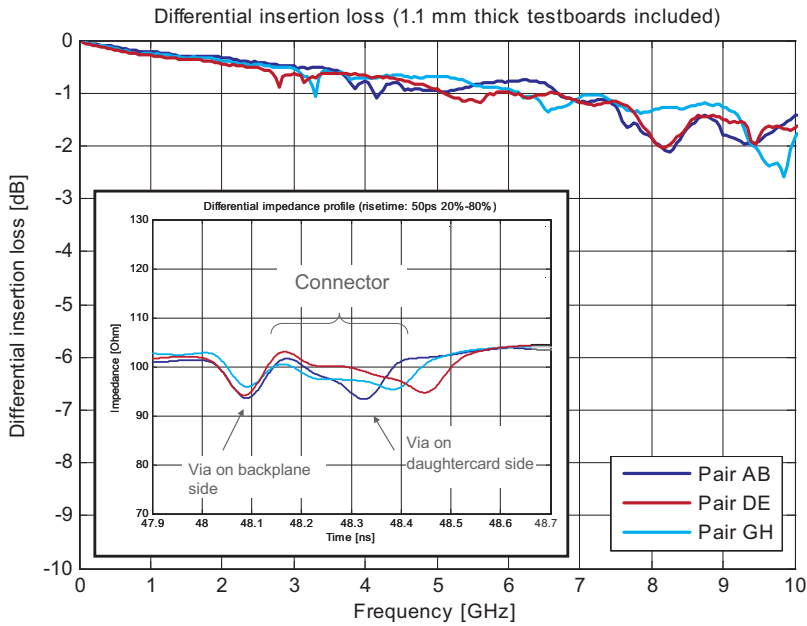

### 1.5 DP/Column High Speed\*\*

Worst Case Noise with recommended TX/RX pinout:  
0.9 % @ 50 ps (20% to 80%)

Noise Summary	Total Asynchronous Noise @ 50 ps Risetime (20% to 80%)	
	2.0 different pairs/column	
Victim Pair	Total Async. NEXT	Total Async. FEXT
Pair AB	1.0 %	0.6 %
Pair DE	0.4 %	0.6 %
Pair GH	1.2 %	0.8 %

\*\* All measurement data include the footprint performance of a 1.1mm thick PCB test-board.

## Connector Offerings: Female Connector

High Speed Version

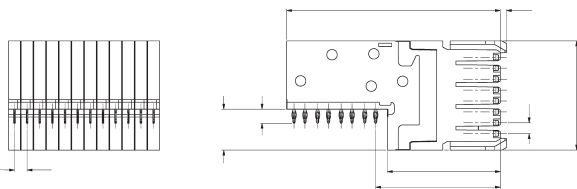

Common Speed Version

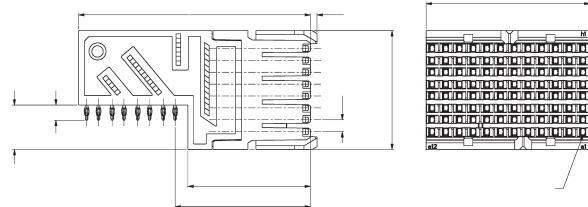

Recommended PCB Layout  
(component side shown)

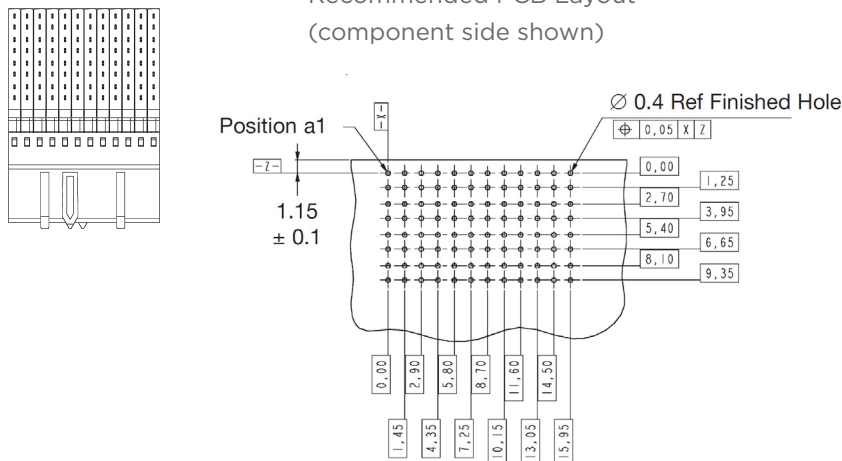

## Connector Offerings: Uniform Male Connector for High and Common Speeds

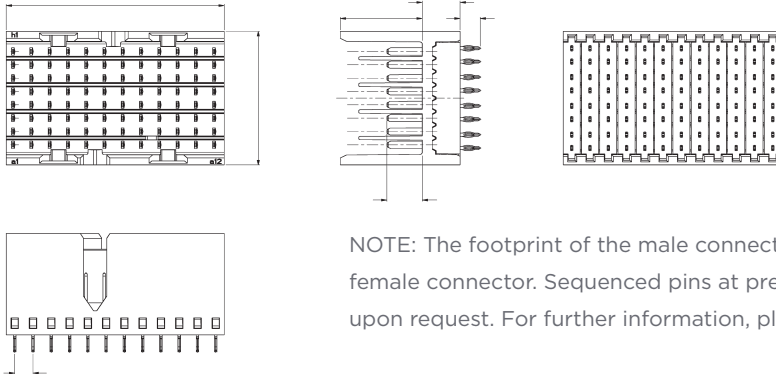

NOTE: The footprint of the male connector is identical to the footprint of the female connector. Sequenced pins at predefined positions can be obtained upon request. For further information, please contact TE.

	Reference Part Numbers				Application Tooling				
	Product Specification	Application Specification	Female	Male	Part Number	Description	Instruction Sheet		
<b>High Speed</b>	108-19353	114-19106	1857657-1	<b>Vertical</b> 2042088-1 2042088-2	1-528508-4	Pin Bending Tool	412-18997		
	108-19320		1857657-2						
<b>Common Speed</b>	108-19354	114-19112	1982738-1	<b>Right Angle</b> 2042162-1 2042162-2 2042139-1 2042139-2	528508-2	Removal Tool	412-18997		
	108-19352		1982738-2		528504-2	Insertion Tool	412-18984		
<b>Power</b>	108-19367	114-19122	1982257-5	1982260-5	4-519564-2	Insertion Tool	412-18969		

## Complementary Products

### Right-Angle Male Connector

- Co-planar application based on right-angle female and right-angle male
- Performance up to 20+ Gbps (in combination with female high-speed connector)

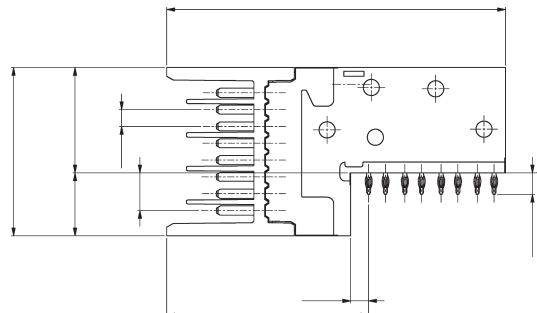
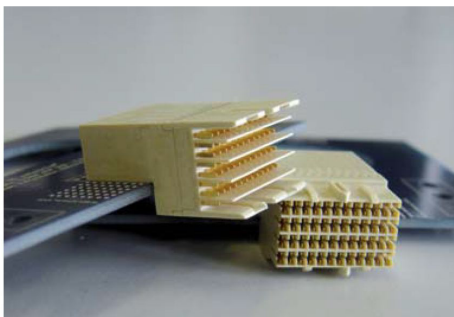

### Power Connector

- Envelope dimensions identical to Z-PACK Slim UHD modules
- High durability (250 cycles)
- Two sequencing levels
- Current carrying capacity >18 Amp per contact

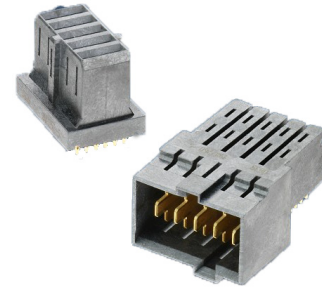

### Power Female Connector:

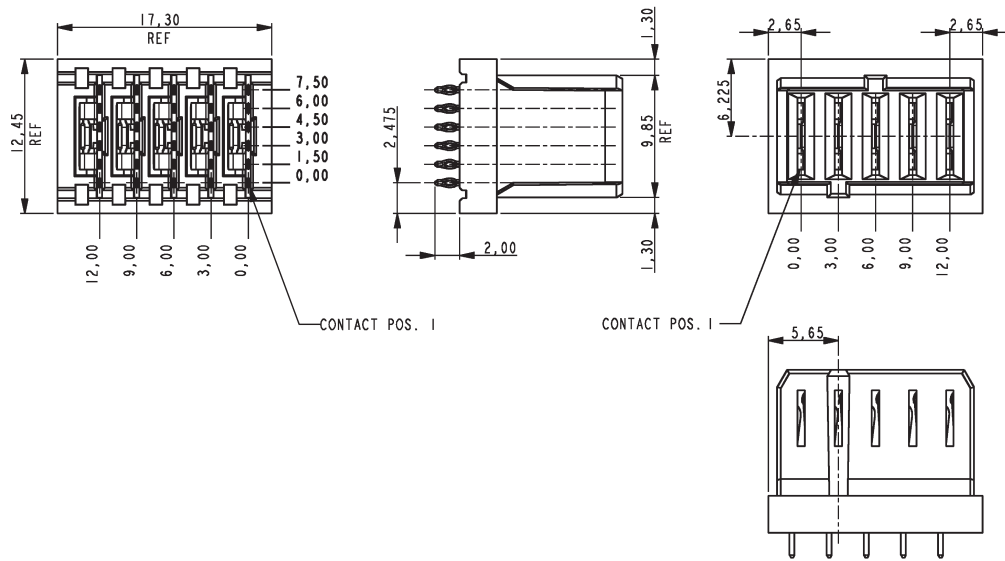

### Power Male Connector: Part No. 1982260-5

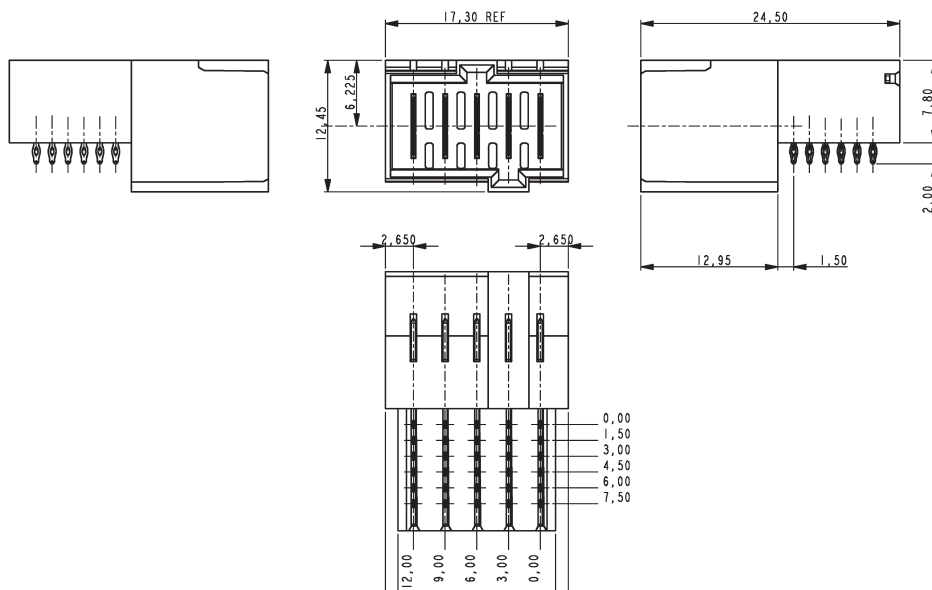

## Guide Pins

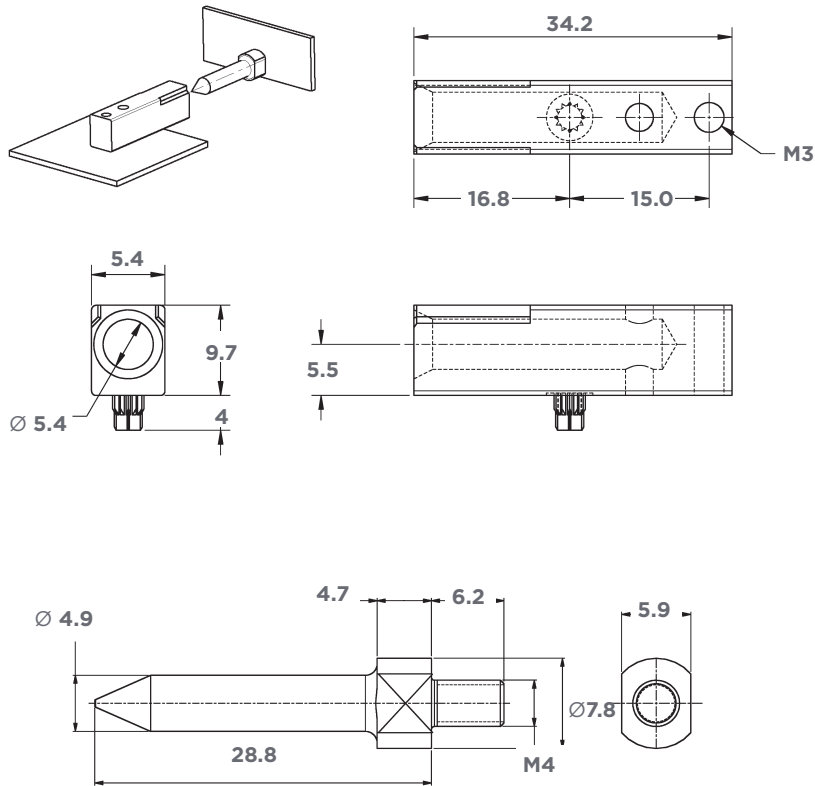

**Female Guide Module**  
**Part No. 223957-3**

**Male Guide Pin**  
**Part No. 1857988-1**

## For More Information

[www.te.com](http://www.te.com)

## TE Technical Support Center

USA: +1 (800) 522-6752  
Canada: +1 (905) 475-6222  
Mexico: +52 (0) 55-1106-0800  
Latin/S. America: +54 (0) 11-4733-2200  
Germany: +49 (0) 6251-133-1999  
UK: +44 (0) 800-267666  
France: +33 (0) 1-3420-8686  
Netherlands: +31 (0) 73-6246-999  
China: +86 (0) 400-820-6015

**te.com**

1654261-5 DTC 1014

© 2014 TE Connectivity Ltd. family of companies. All Rights Reserved. Z-PACK Slim UHD, TE Connectivity, TE Connectivity (logo) and Every Connection