

LCPI

Toroid power inductors

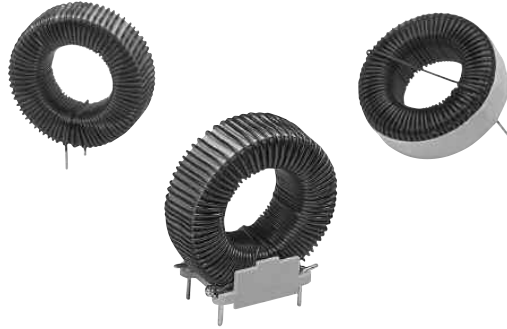

Applications

- Filters
- Buck and boost switches
- Chokes

Product features

- Low loss, iron powder cores with stable electrical operating characteristics maximize inductor efficiency by minimizing copper losses
- Available in vertical and horizontal self leaded and header mounted configurations
- Inductance values range from 10 μH to 1000 μH
- Current values range from 1.5 A to 29.5 A
- Meets UL 94V-0 flammability standard
- Iron powder core material

Environmental Data

- Storage temperature range (Component): -40 °C to +105 °C
- Operating temperature range: -40 °C to +105 °C (ambient plus self-temperature rise)



Product Specifications

Vertical Part Number	Horizontal Part Number	Header Mounted Part Number	OCL ⁽¹⁾ μH +/- 20%	I _{DC} ⁽²⁾ (A)	I _{SAT} ⁽³⁾ (A)	Volt-μsec ⁽⁴⁾ Vμs	Energy ⁽⁵⁾ μJ	DCR (Ω) ⁽⁶⁾ max
CTX10-1-52-R	CTX10-1-52LP-R	CTX10-1-52M-R	10.14	2.4	2.1	5.4	15	0.0481
CTX20-1-52-R	CTX20-1-52LP-R	CTX20-1-52M-R	20.22	1.8	2.2	7.8	36	0.0829
CTX50-1-52-R	CTX50-1-52LP-R	CTX50-1-52M-R	50.29	2.6	2.7	16.3	130	0.0715
CTX100-1-52-R	CTX100-1-52LP-R	CTX100-1-52M-R	100.40	2.5	2.4	27.5	197	0.1060
CTX150-1-52-R	CTX150-1-52LP-R	CTX150-1-52M-R	151.70	2.1	2.3	35.7	283	0.1620
CTX250-1-52-R	CTX250-1-52LP-R	CTX250-1-52M-R	250.90	1.9	2.2	47.8	421	0.2210
CTX500-1-52-R	CTX500-1-52LP-R	CTX500-1-52M-R	505.00	1.7	1.9	77.9	645	0.3610
CTX750-1-52-R	CTX750-1-52LP-R	CTX750-1-52M-R	754.40	1.8	2.4	114.3	1530	0.4340
CTX1000-1-52-R	CTX1000-1-52LPR	CTX1000-1-52M-R	1004.00	1.5	2.1	131.9	1530	0.6380
CTX10-2-52-R	CTX10-2-52LP-R	CTX10-2-52M-R	9.60	4.7	4.5	6.6	68	0.0183
CTX20-2-52-R	CTX20-2-52LP-R	CTX20-2-52M-R	19.60	3.2	3.2	9.4	69	0.0392
CTX50-2-52-R	CTX50-2-52LP-R	CTX50-2-52M-R	50.00	4.9	4.9	21.3	420	0.0326
CTX100-2-52-R	CTX100-2-52LP-R	CTX100-2-52M-R	101.70	4.4	4.3	35.0	643	0.0534
CTX150-2-52-R	CTX150-2-52LP-R	CTX150-2-52M-R	148.00	4.3	4.0	47.6	829	0.0719
CTX250-2-52-R	CTX250-2-52LP-R	CTX250-2-52M-R	251.10	4.2	4.2	66.0	1540	0.0833
CTX500-2-52-R	CTX500-2-52LP-R	CTX500-2-52M-R	499.40	3.1	3.3	104.0	1890	0.1830
CTX750-2-52-R	CTX750-2-52LP-R	CTX750-2-52M-R	749.30	3.4	3.4	147.3	2960	0.2080
CTX10-5-52-R	CTX10-5-52LP-R	CTX10-5-52M-R	9.68	8.7	11.1	9.4	417	0.0104
CTX20-5-52-R	CTX20-5-52LP-R	CTX20-5-52M-R	21.25	7.8	9.3	16.0	643	0.0260
CTX50-5-52-R	CTX50-5-52LP-R	CTX50-5-52M-R	49.60	7.6	9.4	29.3	1530	0.0248
CTX100-5-52-R	CTX100-5-52LP-R	CTX100-5-52M-R	97.20	8.2	7.5	45.7	1890	0.0267
CTX150-5-52-R	CTX150-5-52LP-R	CTX150-5-52M-R	150.60	7.7	7.5	66.0	2960	0.0401
CTX250-5-52-R	CTX250-5-52LP-R		254.40	9.2	8.1	102.4	5860	0.0400
CTX10-7-52-R	CTX10-7-52LP-R	CTX10-7-52M-R	10.04	11.4	13.5	11.0	640	0.0080
CTX20-7-52-R	CTX20-7-52LP-R	CTX20-7-52M-R	20.96	11.4	14.5	19.1	1540	0.0110
CTX50-7-52-R	CTX50-7-52LP-R	CTX50-7-52M-R	52.27	10.5	10.2	33.5	1900	0.0163
CTX100-7-52-R	CTX100-7-52LP-R		101.40	12.0	9.1	54.2	2960	0.0167
CTX150-7-52-R	CTX150-7-52LP-R		152.80	12.8	10.5	79.3	5900	0.0204
CTX10-10-52-R	CTX10-10-52LP-R		10.04	16.9	20.9	13.2	1530	0.0051
CTX20-10-52-R	CTX20-10-52LP-R		21.17	16.0	16.0	21.3	1900	0.0070
CTX50-10-52-R	CTX50-10-52LP-R		52.37	13.9	12.7	38.9	2960	0.0124
CTX100-10-52-R	CTX100-10-52LPR		99.38	17.6	13.0	64.0	5880	0.0109
CTX10-16-52-R	CTX10-16-52LP-R		9.90	27.3	29.3	16.9	2970	0.0032
CTX20-16-52-R	CTX20-16-52LP-R		19.24	31.5	29.5	28.1	5860	0.0034

Notes:

- (1) Open circuit inductance test parameters: 100 kHz, 0.250 Vrms, 0 Adc.
- (2) DC current for an approximate ΔT of 30 °C at +75 °C Ambient with no core loss. See Chart 2 for derating of I_{DC} with core loss.
- (3) Peak current for an approximate 30% roll-off in OCL. For other current levels see Chart 1.
- (4) Applied Volt-Time product (Vμs) across the inductor. This value represents the Vμs at 100 kHz necessary to generate a core loss equal to 10% of the total losses for 30°C rise. For other frequencies and operating levels see Chart 2. (Note: skin effect losses not included.)
- (5) Energy storage (μJ) at I_{SAT}. For other current levels see Chart 1.
- (6) Maximum D.C. resistance at +20 °C.

Dimensions- mm

Vertical and Horizontal Self Leaded Mounting Options								
Vertical P/N See Figure 1	Horizontal P/N See Figure 2	OD (max)	ID (typ)	Ht (max)	X (typ)	Y (typ)	T (typ)	H (typ)
CTX10-1-52-R	CTX10-1-52LP-R	8.6	0.0	4.7	3.8	7.3	0.42	0.67
CTX20-1-52-R	CTX20-1-52LP-R	9.1	0.0	6.7	5.6	7.4	0.37	0.62
CTX50-1-52-R	CTX50-1-52LP-R	16.2	4.2	9.0	7.5	13.7	0.58	0.83
CTX100-1-52-R	CTX100-1-52LP-R	15.5	4.2	12.4	10.7	13.7	0.58	0.83
CTX150-1-52-R	CTX150-1-52LP-R	20.7	6.6	9.4	7.8	18.8	0.52	0.77
CTX250-1-52-R	CTX250-1-52LP-R	20.9	6.0	13.0	11.0	18.8	0.52	0.77
CTX500-1-52-R	CTX500-1-52LP-R	24.0	9.0	15.3	14.0	21.2	0.52	0.77
CTX750-1-52-R	CTX750-1-52LP-R	29.8	11.7	17.4	15.6	28.2	0.52	0.77
CTX1000-1-52-R	CTX1000-1-52LP-R	29.8	11.7	17.1	15.5	28.0	0.46	0.71
CTX10-2-52-R	CTX10-2-52LP-R	12.7	0.0	7.8	6.3	11.0	0.71	0.96
CTX20-2-52-R	CTX20-2-52LP-R	12.5	0.0	7.5	6.3	11.0	0.58	0.83
CTX50-2-52-R	CTX50-2-52LP-R	21.6	6.1	13.6	11.0	19.5	0.89	1.14
CTX100-2-52-R	CTX100-2-52LP-R	24.0	8.8	16.6	13.9	21.8	0.89	1.14
CTX150-2-52-R	CTX150-2-52LP-R	30.6	11.2	11.4	9.3	28.5	0.80	1.05
CTX250-2-52-R	CTX250-2-52LP-R	31.2	9.1	19.0	15.7	28.5	0.89	1.14
CTX500-2-52-R	CTX500-2-52LP-R	36.7	11.7	14.8	12.5	34.5	0.71	0.96
CTX750-2-52-R	CTX750-2-52LP-R	43.3	19.9	18.2	15.8	41.5	0.80	1.05
CTX10-5-52-R	CTX10-5-52LP-R	22.2	5.4	13.9	11.5	19.9	1.11	1.36
CTX20-5-52-R	CTX20-5-52LP-R	24.5	8.8	16.6	14.5	22.0	0.89	1.14
CTX50-5-52-R	CTX50-5-52LP-R	32.3	10.1	18.9	16.5	28.8	1.11	1.36
CTX100-5-52-R	CTX100-5-52LP-R	37.8	11.2	16.8	13.6	35.5	1.24	1.49
CTX150-5-52-R	CTX150-5-52LP-R	46.4	18.8	19.8	16.8	43.4	1.24	1.49
CTX250-5-52-R	CTX250-5-52LP-R	53.7	18.8	24.3	20.1	49.4	1.38	1.63
CTX10-7-52-R	CTX10-7-52LP-R	25.7	6.5	18.0	16.0	22.4	1.38	1.63
CTX20-7-52-R	CTX20-7-52LP-R	32.4	8.5	19.8	16.8	29.2	1.38	1.63
CTX50-7-52-R	CTX50-7-52LP-R	39.0	10.8	16.8	13.9	35.7	1.38	1.63
CTX100-7-52-R	CTX100-7-52LP-R	48.5	17.1	21.8	17.2	43.4	1.73	1.98
CTX150-7-52-R	CTX150-7-52LP-R	54.5	17.1	25.4	21.2	50.9	1.73	1.98
CTX10-10-52-R	CTX10-10-52LP-R	34.0	7.0	21.4	17.0	29.6	1.73	1.98
CTX20-10-52-R	CTX20-10-52LP-R	40.5	9.0	18.0	14.3	35.2	1.73	1.98
CTX50-10-52-R	CTX50-10-52LP-R	47.5	17.1	21.3	17.5	42.8	1.73	1.98
CTX100-10-52-R	CTX100-10-52LP-R	57.0	15.0	27.5	21.3	50.6	2.15	2.45
CTX10-16-52-R	CTX10-16-52LP-R	50.3	13.0	24.0	18.6	43.0	2.41	2.70
CTX20-16-52-R	CTX20-16-52LP-R	59.0	13.0	28.0	23.0	50.7	2.69	2.99

Note: All dimensions are in millimeters.



**VERTICAL
SELF LEADED
MOUNT**



**HORIZONTAL
SELF LEADED
MOUNT**

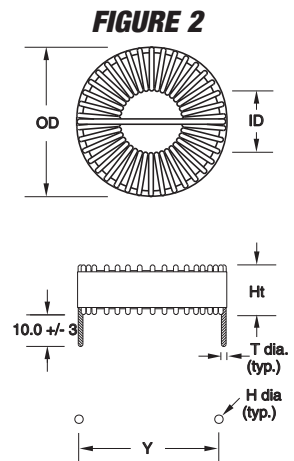
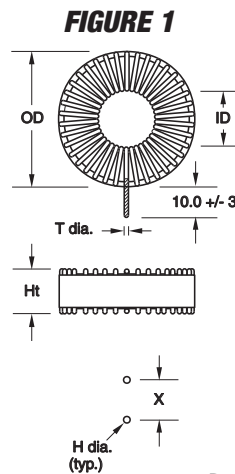

Drawings are not to scale.

Dimensions- mm

Header Mounted Option									
Header Mounted Part Number	See Figure #	OD (max)	A (max)	B (max)	C (max)	X (typ)	Y (typ)	T (typ)	H (typ)
CTX10-1-52M-R	3	8.6	9.4	9.4	6.9	6.5	6.5	—	—
CTX20-1-52M-R	3	9.1	9.4	9.4	9.0	6.5	6.5	—	—
CTX50-1-52M-R	4	16.2	19.6	16.1	20.0	15.3	6.4	—	—
CTX100-1-52M-R	4	15.5	19.6	16.1	19.7	15.3	6.4	—	—
CTX150-1-52M-R	4	20.7	19.6	16.1	24.2	15.3	6.4	—	—
CTX250-1-52M-R	5	20.9	31.0	16.0	22.5	20.3	10.2	1.20	1.45
CTX500-1-52M-R	5	24.0	35.4	21.7	25.0	23.0	15.4	1.20	1.45
CTX750-1-52M-R	5	29.8	35.4	21.7	31.6	23.0	15.4	1.20	1.45
CTX1000-1-52M-R	5	29.8	35.4	21.7	31.2	23.0	15.4	1.20	1.45
CTX10-2-52M-R	3	12.7	13.6	11.4	11.7	10.8	7.5	—	—
CTX20-2-52M-R	3	12.5	13.6	11.4	11.4	10.8	7.5	—	—
CTX50-2-52M-R	5	21.6	31.0	16.0	23.5	20.3	10.2	1.20	1.45
CTX100-2-52M-R	5	24.0	35.4	21.7	26.0	23.0	15.4	1.20	1.45
CTX150-2-52M-R	5	30.6	31.0	16.0	32.5	20.3	10.2	1.20	1.45
CTX250-2-52M-R	5	31.2	35.4	21.7	33.4	23.0	15.4	1.20	1.45
CTX500-2-52M-R	5	36.7	31.0	16.0	38.4	20.3	10.2	1.20	1.45
CTX750-2-52M-R	5	43.3	35.4	21.7	45.4	23.0	15.4	1.20	1.45
CTX10-5-52M-R	5	22.2	31.0	16.0	22.7	20.3	10.2	1.20	1.45
CTX20-5-52M-R	5	24.5	35.4	21.7	25.5	23.0	15.4	1.20	1.45
CTX50-5-52M-R	5	32.3	35.4	21.7	33.7	23.0	15.4	1.11	1.36
CTX100-5-52M-R	5	37.8	35.4	21.7	40.2	23.0	15.4	1.24	1.49
CTX150-5-52M-R	5	46.4	35.4	21.7	47.0	23.0	15.4	1.24	1.49
CTX10-7-52M-R	5	25.7	35.4	21.7	26.7	23.0	15.4	1.38	1.63
CTX20-7-52M-R	5	32.4	35.4	21.7	34.2	23.0	15.4	1.38	1.63
CTX50-7-52M-R	5	39.0	35.4	21.7	40.3	23.0	15.4	1.38	1.63

Note: All dimensions are in millimeters.

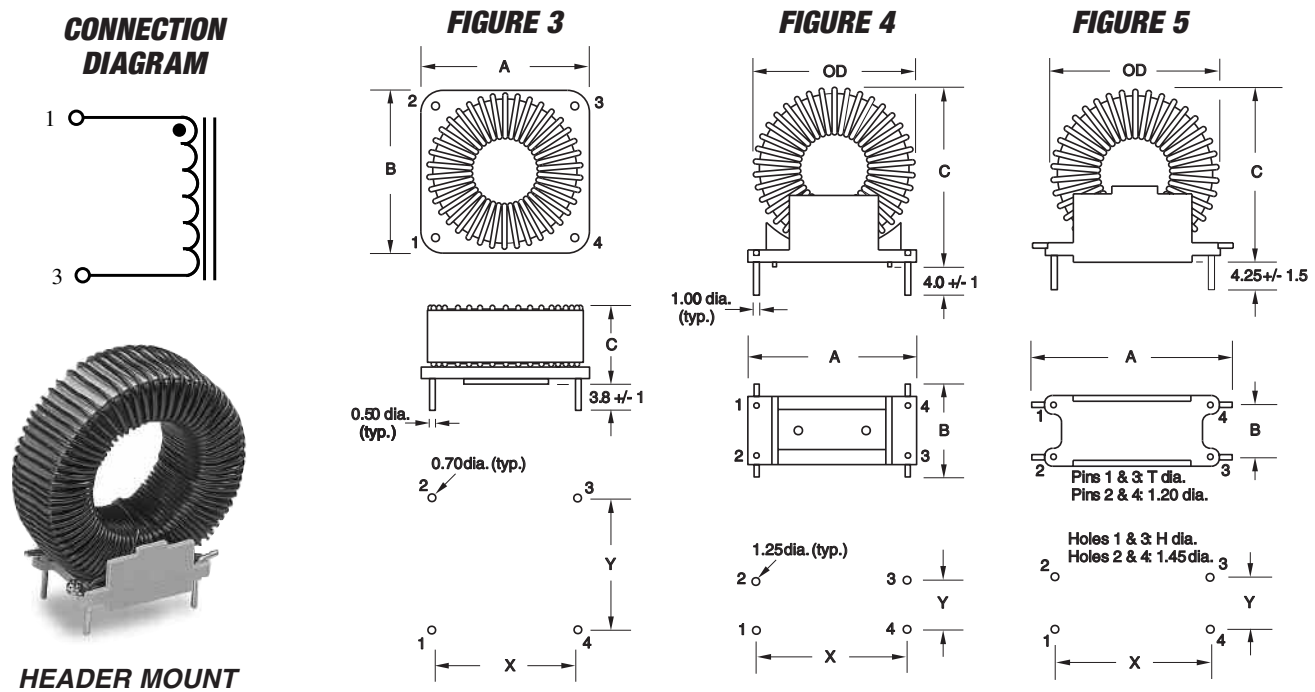

Drawings are not to scale.

Figure4

Core loss

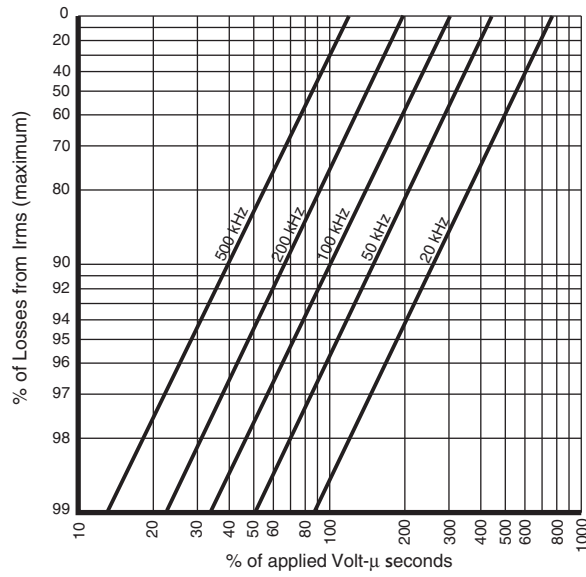

Inductance characteristics

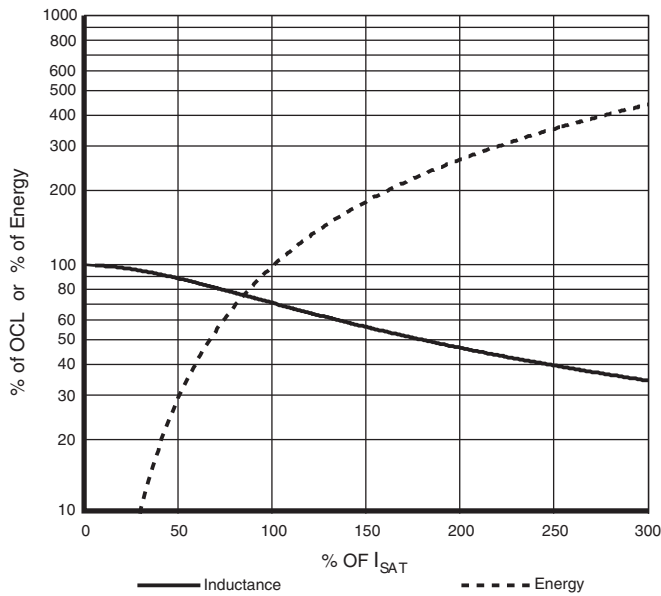

Wave solder profile- Through-hole components

Reflow soldering not recommended

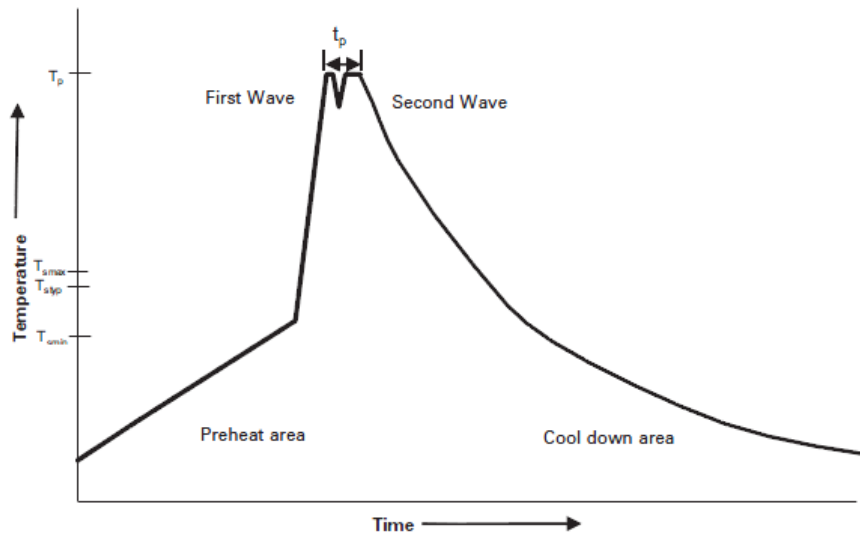

Reference EN 61760-1:2006

Profile Feature	Standard SnPb Solder	Lead (Pb) Free Solder
Preheat	• Temperature min. (T_{smin})	100°C
	• Temperature typ. (T_{styp})	120°C
	• Temperature max. (T_{smax})	130°C
	• Time (T_{smin} to T_{smax}) (t_s)	70 seconds
Δ preheat to max Temperature	150°C max.	150°C max.
Peak temperature (T_p)*	235°C – 260°C	250°C – 260°C
Time at peak temperature (t_p)	10 seconds max 5 seconds max each wave	10 seconds max 5 seconds max each wave
Ramp-down rate	~ 2 K/s min ~3.5 K/s typ ~5 K/s max	~ 2 K/s min ~3.5 K/s typ ~5 K/s max
Time 25°C to 25°C	4 minutes	4 minutes

Manual solder

350°C, 4-5 seconds. (by soldering iron), generally manual, hand soldering is not recommended.

Life Support Policy: Eaton does not authorize the use of any of its products for use in life support devices or systems without the express written approval of an officer of the Company. Life support systems are devices which support or sustain life, and whose failure to perform, when properly used in accordance with instructions for use provided in the labeling, can be reasonably expected to result in significant injury to the user.

Eaton reserves the right, without notice, to change design or construction of any products and to discontinue or limit distribution of any products. Eaton also reserves the right to change or update, without notice, any technical information contained in this bulletin.

Eaton
Electronics Division
1000 Eaton Boulevard
Cleveland, OH 44122
United States
www.eaton.com/electronics

© 2017 Eaton
All Rights Reserved
Printed in USA
Publication No. 4304
July 2017