

TR4

FPGA Development Kit

User Manual

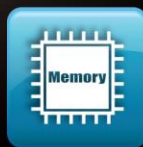
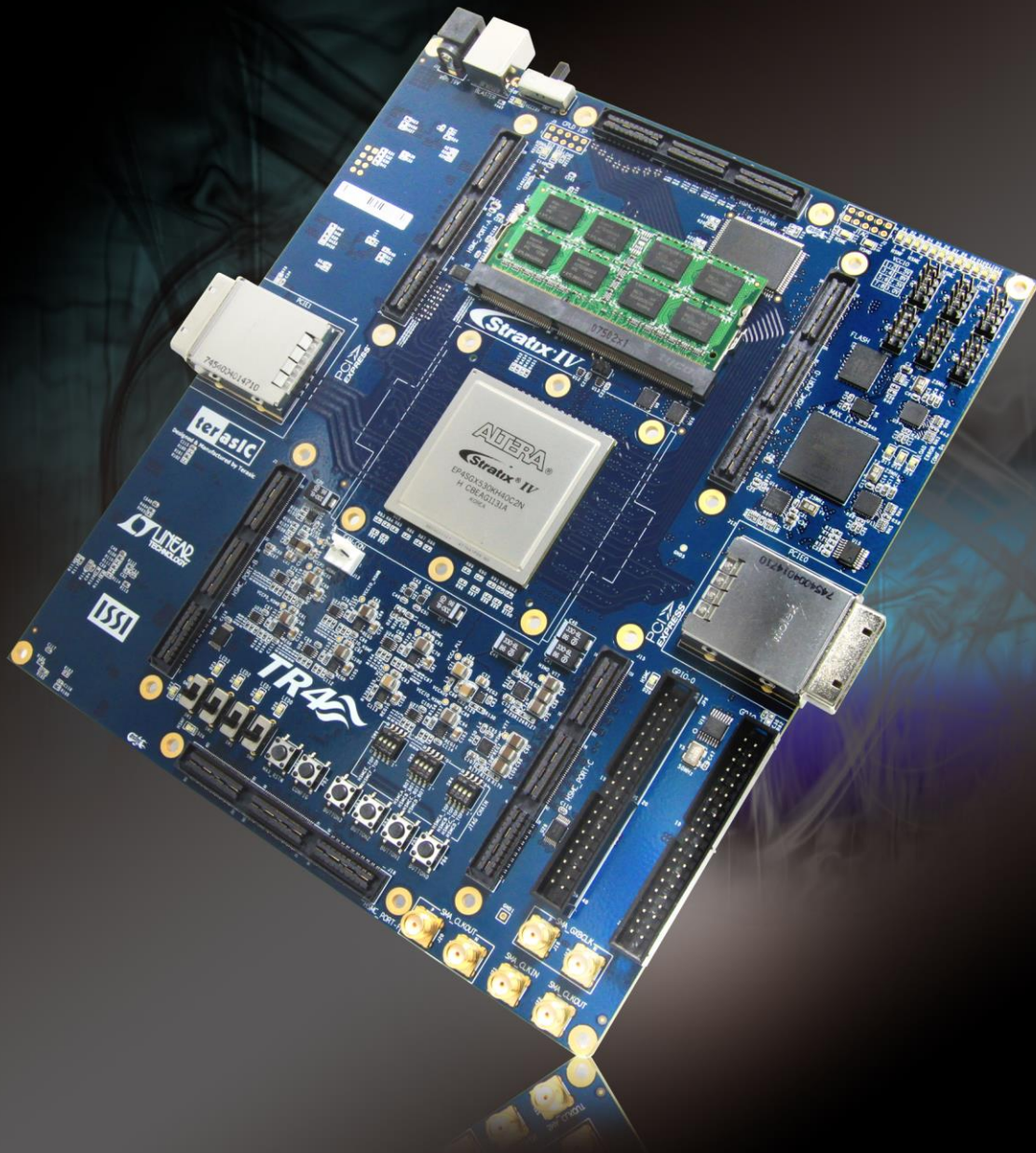

CHAPTER 1	<i>OVERVIEW</i>	1
1.1	GENERAL DESCRIPTION	1
1.2	KEY FEATURES	2
1.3	BOARD OVERVIEW	3
1.4	BLOCK DIAGRAM	4
1.5	ASSEMBLY	8
CHAPTER 2	<i>USING THE TR4 BOARD</i>	9
2.1	CONFIGURATION OPTIONS	9
2.2	SETUP ELEMENTS	16
2.3	STATUS ELEMENTS	17
2.4	GENERAL USER INPUT/OUTPUT	18
2.5	HIGH-SPEED MEZZANINE CARDS	20
2.6	GPIO EXPANSION HEADERS	32
2.7	DDR3 SO-DIMM	36
2.8	CLOCK CIRCUITRY	40
2.9	PCI EXPRESS	45
2.10	FLASH MEMORY	48
2.11	SSRAM MEMORY	51
2.12	TEMPERATURE SENSOR AND FAN	53
2.13	POWER	53
2.14	SECURITY	54
2.15	USING EXTERNAL BLASTER	54
CHAPTER 3	<i>CONTROL PANEL</i>	56
3.1	CONTROL PANEL SETUP	56
3.2	CONTROLLING THE LEDs	60
3.3	SWITCHES AND PUSH-BUTTONS	61
3.4	MEMORY CONTROLLER	62
3.5	TEMPERATURE MONITOR	65
3.6	PLL	66
3.7	HSMC	67
3.8	FAN	68

3.9 INFORMATION	69
CHAPTER 4 TR4 SYSTEM BUILDER.....	71
4.1 INTRODUCTION	71
4.2 GENERAL DESIGN FLOW	72
4.3 USING TR4 SYSTEM BUILDER.....	73
CHAPTER 5 EXAMPLES OF ADVANCED DEMONSTRATION.....	83
5.1 BREATHING LEDs.....	83
5.2 EXTERNAL CLOCK GENERATOR	84
5.3 HIGH SPEED MEZZANINE CARD (HSMC)	90
5.4 DDR3 SDRAM (1GB)	92
5.5 DDR3 SDRAM (4GB)	96
ADDITIONAL INFORMATION.....	100

This chapter provides an overview of the TR4 Development Board and details the components and features of the board.

1.1 General Description

The TR4 Development Board provides the ideal hardware platform for system designs that demand high-performance, serial connectivity, and advanced memory interfacing. Developed specifically to address the rapidly evolving requirements in many end markets for greater bandwidth, improved jitter performance, and lower power consumption, the TR4 is powered by the Stratix® IV GX device and supported by industry-standard peripherals, connectors and interfaces that offer a rich set of features that is suitable for a wide range of compute-intensive applications.

The advantages of the Stratix® IV GX FPGA platform with integrated transceivers have allowed the TR4 to be fully compliant with version 2.0 of the PCI Express standard. This will accelerate mainstream development of PCI Express-based applications and enable customers to deploy designs for a broad range of high-speed connectivity applications.

The TR4 is supported by multiple reference designs and six High-Speed Mezzanine Card (HSMC) connectors that allow scaling and customization with mezzanine daughter cards. For large-scale ASIC prototype development, multiple TR4s can be stacked together to create an easily-customizable multi-FPGA system.

1.2 Key Features

Featured Device

- Altera Stratix® IV GX FPGA (EP4SGX230C2/EP4SGX530C2)

Configuration and Set-up Elements

- Built-in USB Blaster circuit for programming
- Fast passive parallel (FPP) configuration via MAX II CPLD and FLASH

Components and Interfaces

- Six HSMC connectors (two with transceiver support)
- Two 40-pin GPIO expansion headers (shares pins with HSMC Port C)
- Two external PCI Express 2.0 (x4 lane) connectors

Memory

- DDR3 SO-DIMM socket (8GB Max)
- 64MB FLASH
- 2MB SSRAM

General User Input/Output:

- Four LEDs
- Four push-buttons
- Four slide switches

Clock system

- On-board 50MHz oscillator
- Three on-board programmable PLL timing chips
- SMA connector pair for differential clock input
- SMA connector pair for differential clock output
- SMA connector for external clock input
- SMA connector for clock output

Other

- Temperature sensor
- FPGA cooling fan

1.3 Board Overview

Figure 1-1 and Figure 1-2 show the top and bottom view of the TR4 board. It depicts the layout of the board and indicates the location of the connectors and key components. Users can refer to these figures for relative location when the connectors and key components are introduced in the following chapters.

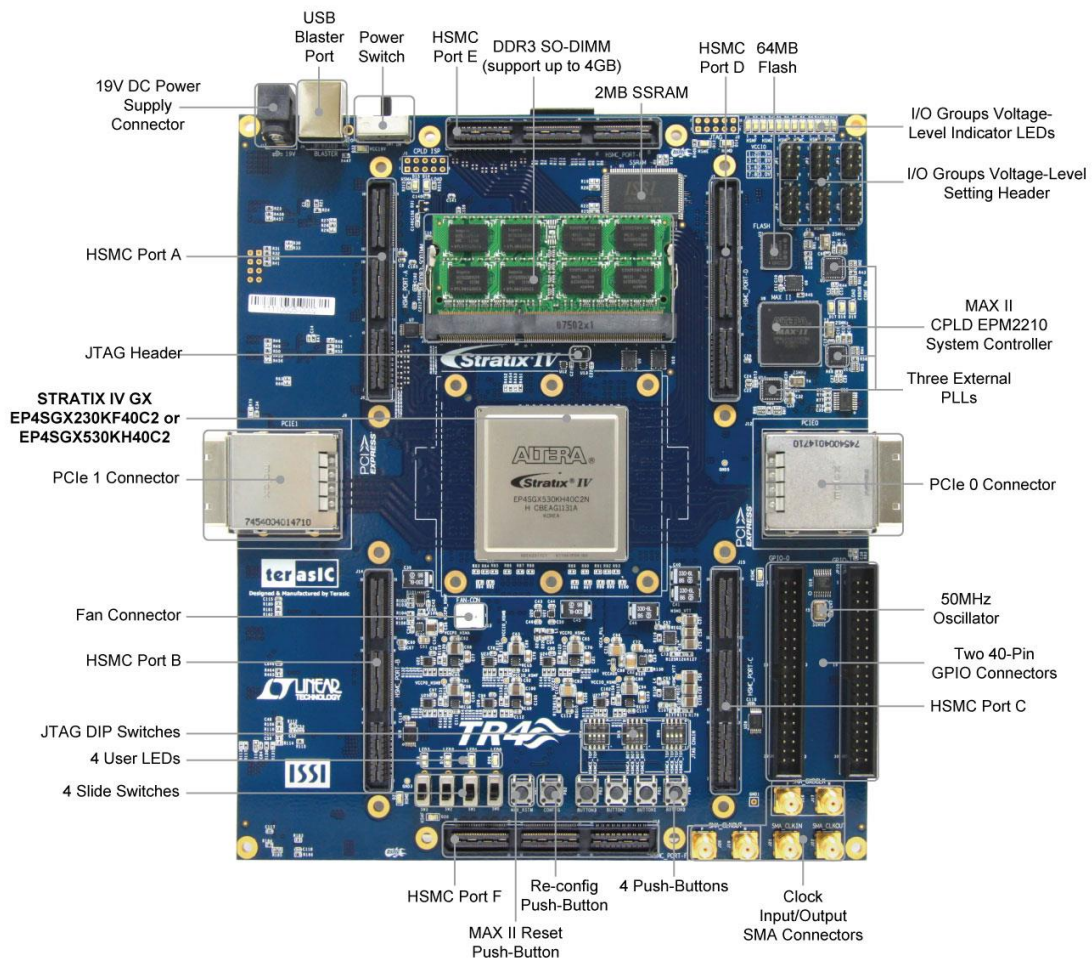

Figure 1-1 TR4 Board View (Top)

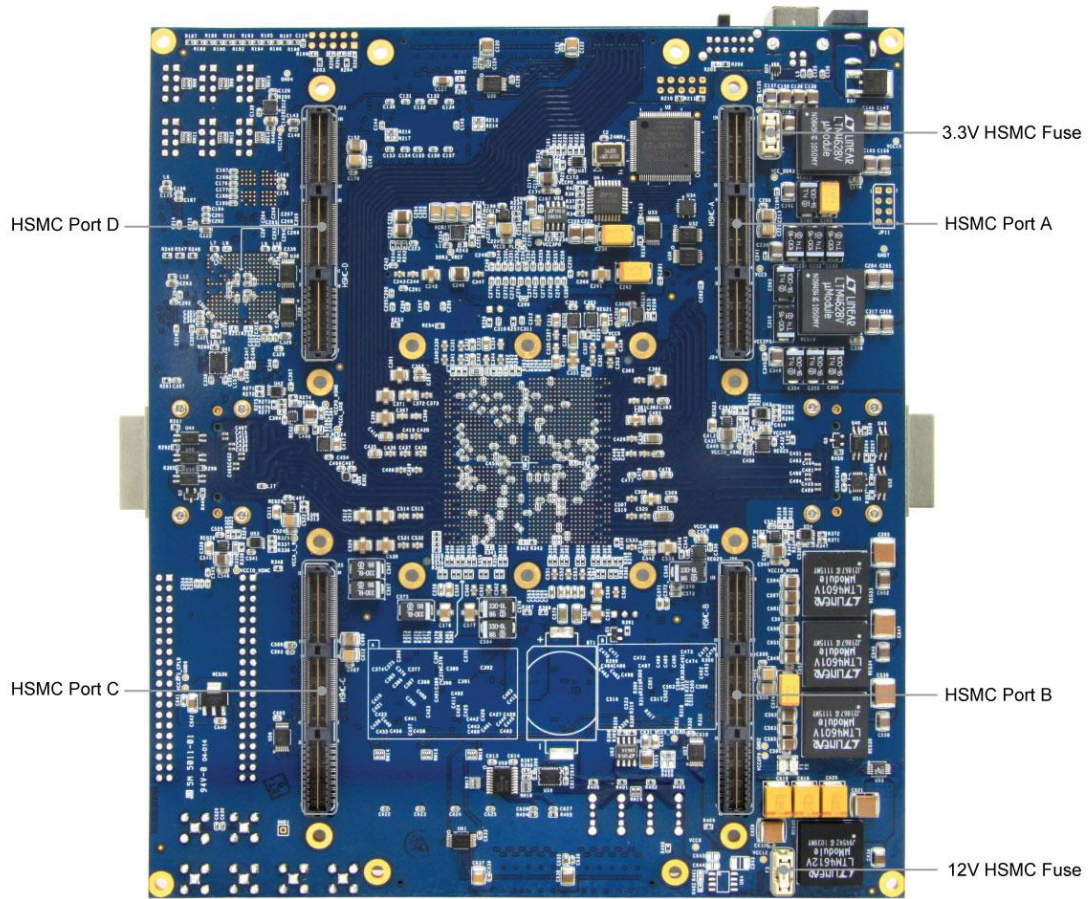

Figure 1-2 TR4 Board View (Bottom)

1.4 Block Diagram

Figure 1-3 shows the block diagram of the TR4 board. To provide maximum flexibility for the users, all key components are connected with the Stratix IV GX FPGA device, allowing the users to implement any system design.

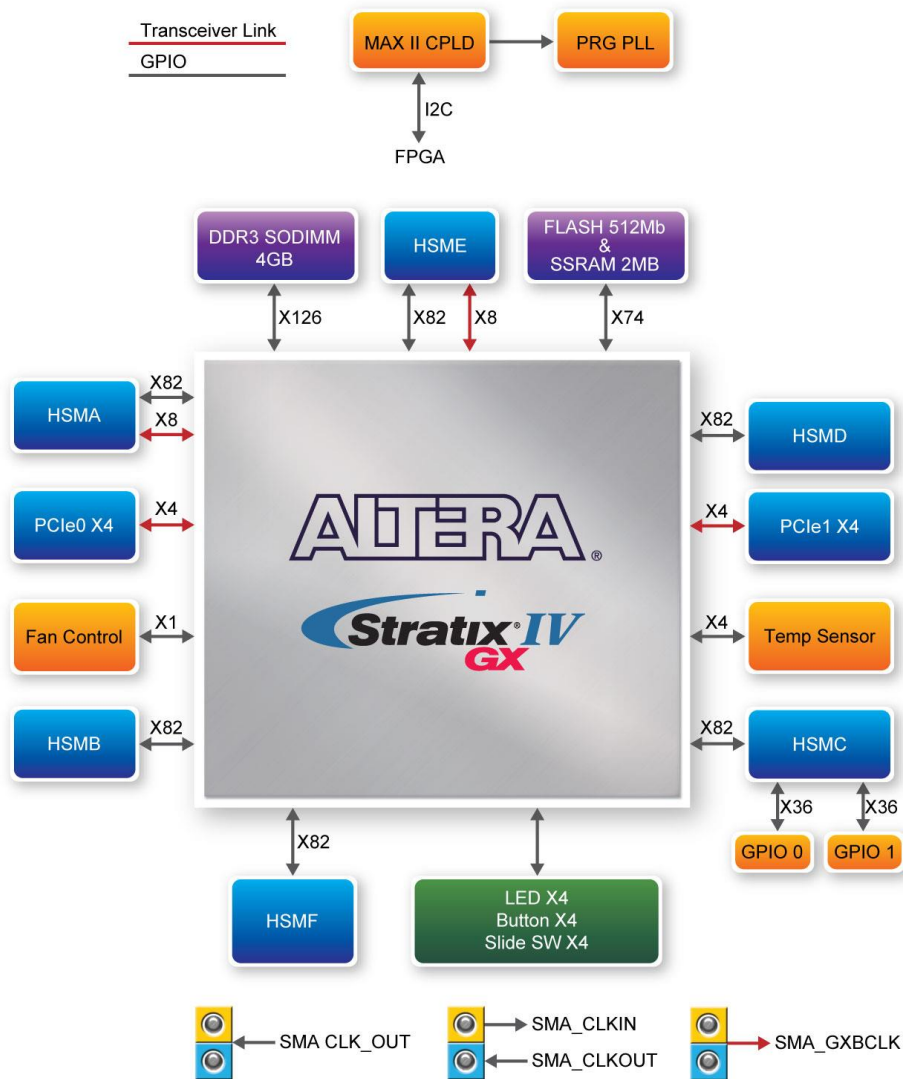

Figure 1-3 TR4 Block Diagram

Below is more detailed information regarding the blocks in **Figure 1-3**.

Stratix IV GX FPGA

EP4SGX230C2

- 228,000 logic elements (LEs)
- 17,133 total memory Kb
- 1,288 18x18-bit multipliers blocks
- 2 PCI Express hard IP blocks

- 744 user I/Os
- 8 phase locked loops (PLLs)

EP4SGX530C2

- 531,200 logic elements (LEs)
- 27,376K total memory Kb
- 1,024 18x18-bit multipliers blocks
- 4 PCI Express hard IP blocks
- 744 user I/Os
- 8 phase locked loops (PLLs)

Configuration Device and USB Blaster Circuit

- MAXII CPLD EPM2210 System Controller and Fast Passive Parallel (FPP) configuration
- On-board USB Blaster for use with the Quartus II Programmer
- Programmable PLL timing chip configured via MAX II CPLD
- Supports JTAG mode

Memory Devices

- 64MB Flash (32M x16) with a 16-bit data bus
- 2MB SSRAM (512K x 32)

DDR3 SO-DIMM Socket

- Up to 8GB capacity
- Maximum memory clock rate at 533MHz
- Theoretical bandwidth up to 68Gbps

LEDs

- 4 user-controllable LEDs
- Active-low|

Push-buttons

- 4 user-defined inputs
- Active-low

Slide Switches

- 4 slide switches for user-defined inputs
- Logic low for DOWN position; Logic high for UP position

On-Board Clocking Circuitry

- 50MHz oscillator
- SMA connector pair for differential clock inputs
- SMA connector pair for differential clock outputs
- SMA connector for external clock input
- SMA connector for clock output

Two PCI Express x4 Edge Connectors

- Support connection speed of Gen1 at 2.5Gbps/lane to Gen2 at 5.0Gbps/lane
- Support downstream mode

Six High Speed Mezzanine Card (HSMC) Connectors

- Two HSMC ports include 16 pairs of CDR-based transceivers at data rates of up to 6.5Gbps
- Among HSMC Port A to D, there are 55 true LVDS TX channels to 1.6Gbps and 17 emulated LVDS TX channels up to 1.1Gbps whereas there are 9 additional TX channels from HSMC Port E.
- Configurable I/O standards - 1.5V, 1.8V, 2.5V, 3.0V

Two 40-pin GPIO Expansion Headers

- 72 FPGA I/O pins; 4 power and ground lines
- Shares pins with HSMC Port C
- Configurable I/O standards: 1.5V, 1.8V, 2.5V, 3.0V

Power

- Standalone DC 19V input

Other

- Temperature Sensor
- Cooling Fan

1.5 Assembly

Attach the included rubber (silicon) foot stands, as shown in **Figure 1-4**, to each of the four copper stands on the TR4 board.



Figure 1-4 Mount Silicon Foot Stands

Chapter 2

Using the TR4 Board

This chapter gives instructions for using the TR4 board and its components.

It is strongly recommended that users read the *TR4 Getting Started Guide.pdf* before operating the TR4 board. The document is located in the *Usermanual* folder on the **TR4 System CD**. The contents of the document include the following:

- Introduction to the TR4 Development Board
- TR4 Development Kit Contents
- Key Features
- Before You Begin
- Software Installation
- Development Board Setup
- Programming the Stratix IV GX Device
- Programming through Flash

2.1 Configuration Options

■ JTAG FPGA Programming with USB-Blaster

The USB-blaster is implemented on the TR4 board to provide a JTAG configuration through the on-board USB-to-JTAG configuration logic through the type-B USB connector, an FTDI USB 2.0 PHY device, and an Altera MAX II CPLD. For this programming mode, configuration data will be lost when the power is turned off.

To download a configuration bit stream into the Stratix IV GX FPGA, perform the following steps:

- Make sure that power is provided to the TR4 board.
- Open JP7 to bypass the JTAG interface of the HSMC if it won't be used.
- Connect the USB cable supplied directly to the USB Blaster port of the TR4 board (see [Figure 2-1](#)).
- The FPGA can now be programmed in the Quartus II Programmer by selecting a configuration bit stream file with the .sof filename extension.
- If users need to use the JTAG interface on HSMC, please refer to Section 2.2 for detailed HSMC JTAG switch settings.

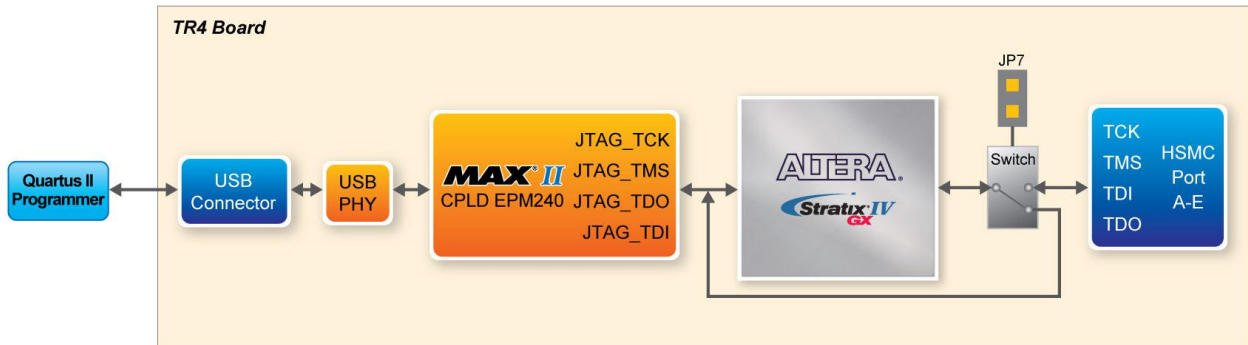

Figure 2-1 JTAG Configuration Scheme

■ JTAG FPGA Programming with External Blaster

The TR4 board supports JTAG programming over external blaster via J2. To use this interface, users need to solder a 2x5 pin connector (2.54mm pitch) to J2. Make sure JP7 is open to bypass the JTAG interface of HSMC.

■ Flash Programming

The TR4 development board contains a common Flash interface (CFI) memory to meet the demands for larger FPGA configurations. The Parallel Flash Loader (PFL) feature in MAX II devices provides an efficient method to program CFI flash memory devices through the JTAG interface and the logic to control configuration from the flash memory device to the Stratix IV GX FPGA. [Figure 2-2](#) depicts the connection setup between the CFI flash memory, Max II CPLD, and Stratix IV GX.

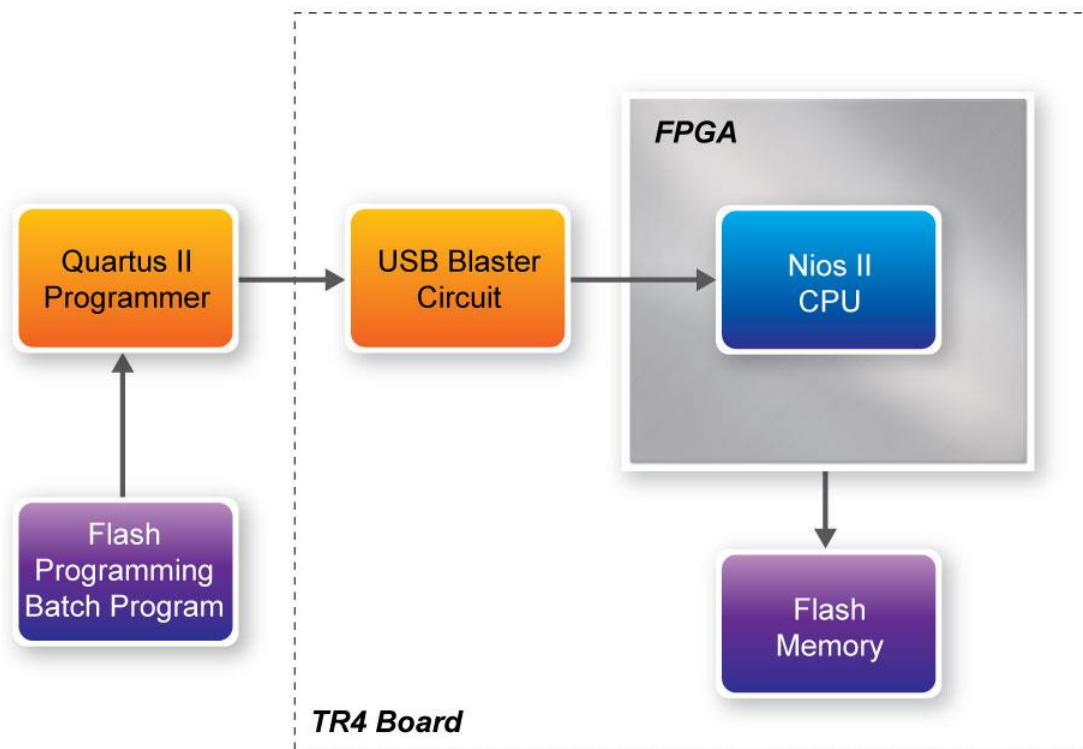

Figure 2-2 Flash Programming Scheme

■ Programming Flash Memory using Batch File

The TR4 provides a batch file (program_Flash.bat) to limit the steps that are taken when users program the flash memory on the TR4.

■ Software Requirements:

- Quartus II 11.1 or later
- Nios II IDE 11.1 or later
- Program_Flash folder contents:
 - Program_Flash.bat
 - Program_Flash.pl
 - Program_Flash.sh
 - tr4_default_flash_loader.sof
 - boot_loader_cfi.srec

Before you use the program_Flash.bat batch file to program the flash memory, make sure the TR4 is

turned on and USB cable is connected to the USB blaster port (J4). In addition, place the .sof and .elf file you wish to program/convert in the *Program_Flash* directory.

Programming Flash Memory with .sof using Program_Flash.bat

1. Launch the program_Flash.bat batch file from the directory (*demonstrations\TR4_<Stratix device>\TR4_Default_Flash_Loaderr\Program_Flash*) of the **TR4 system CD-ROM**.
2. The Flash program tool shows the menu options.

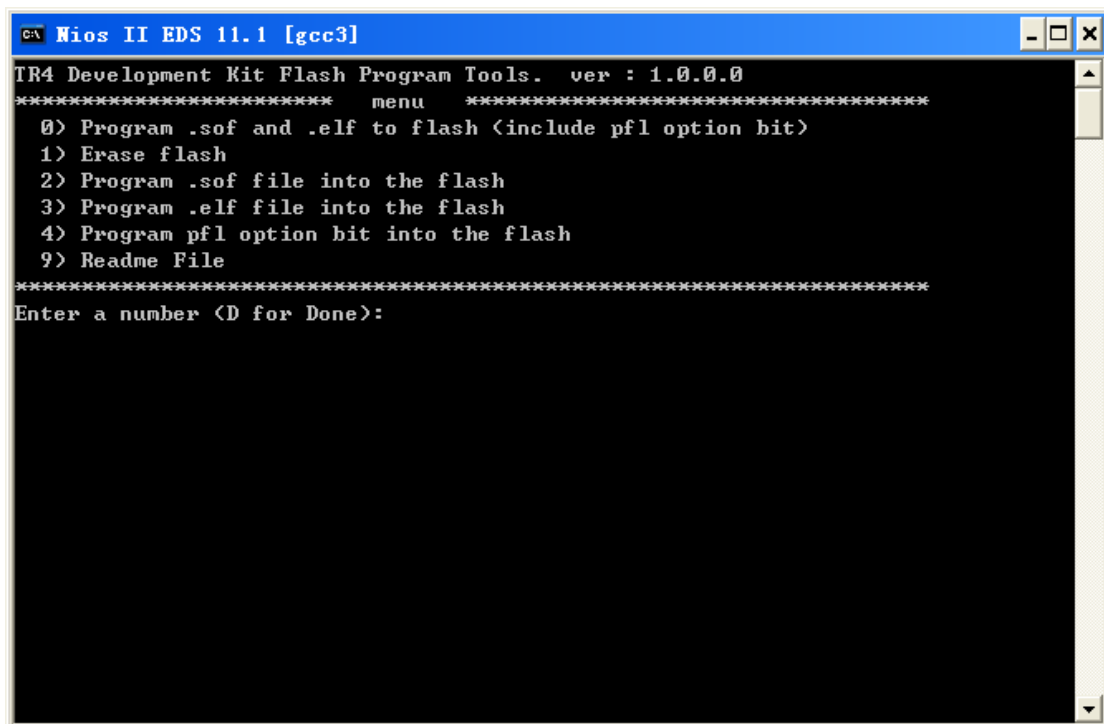

Figure 2-3 Flash Program Tools

3. Select option 2.

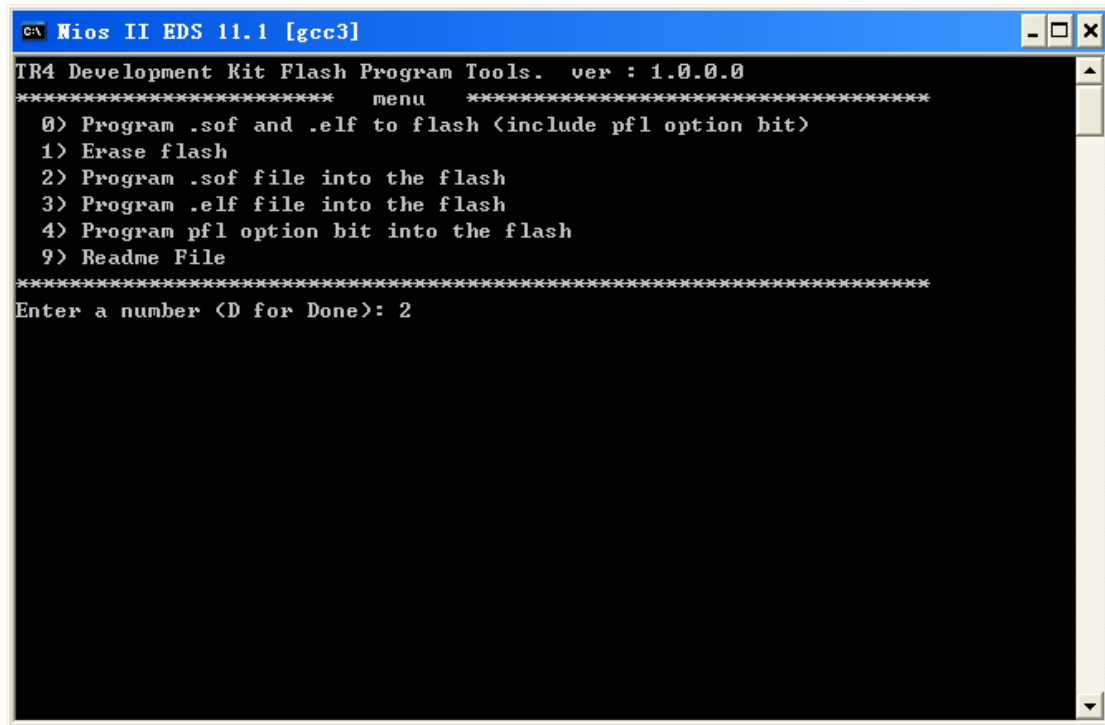

Figure 2-4 Option 2

4. Enter the .sof file name to be programmed onto the flash memory.

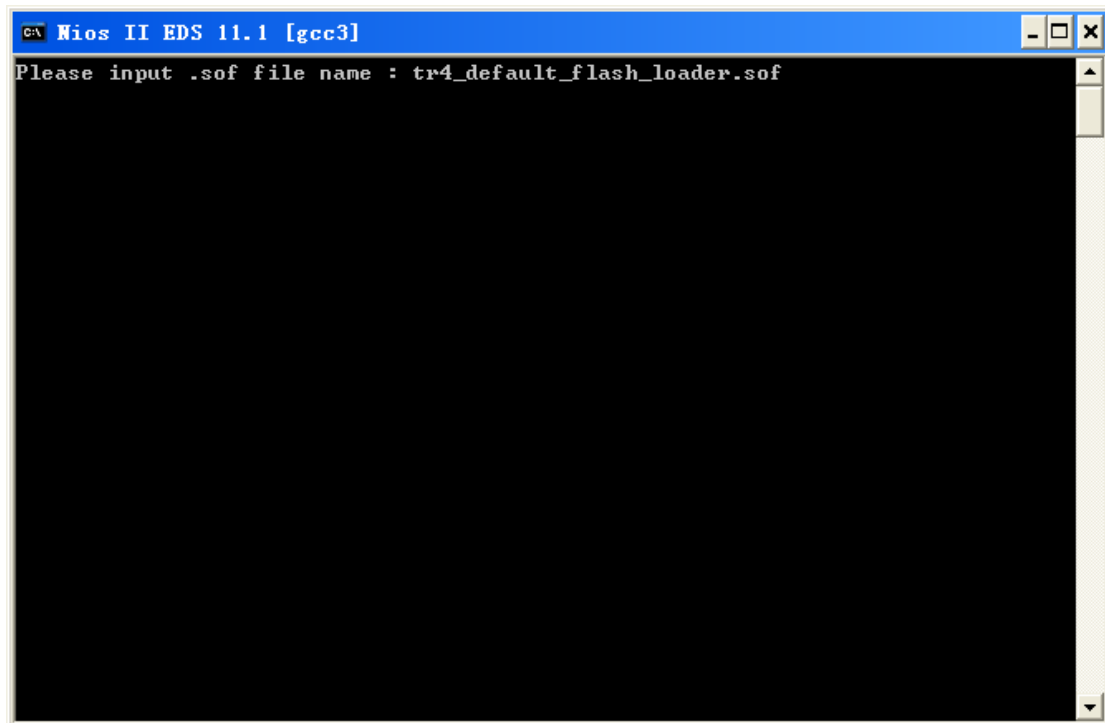
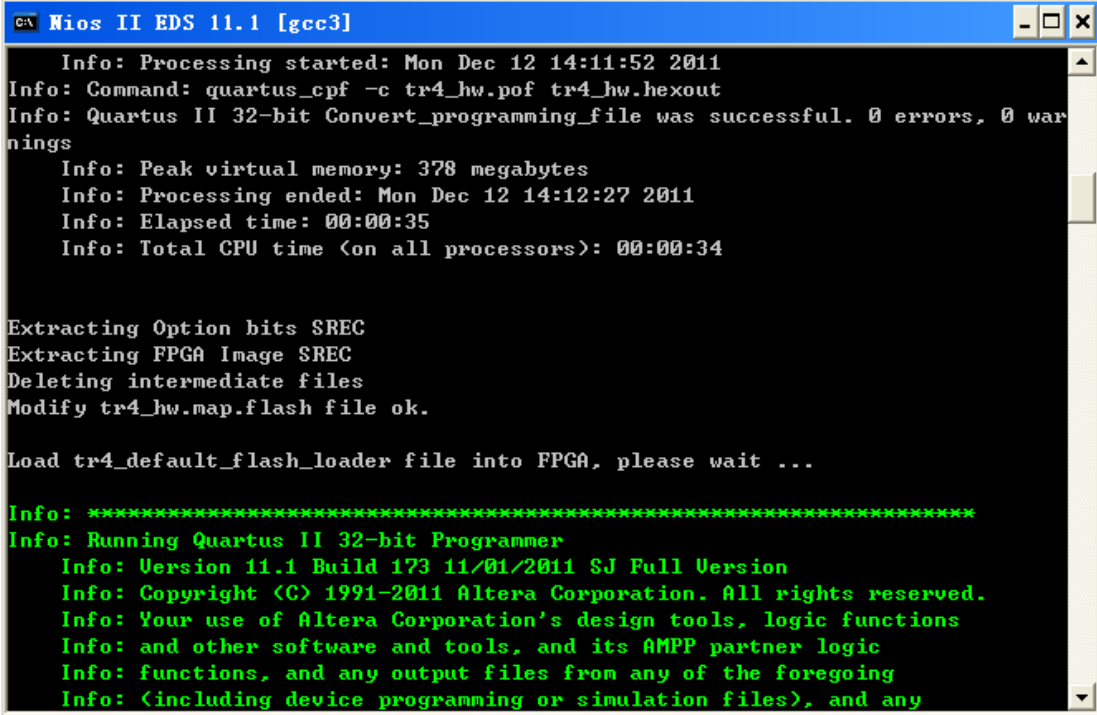

Figure 2-5 Enter .sof Name to Program

5. The following lines will appear during Flash programming: ‘Extracting Option bits SREC’, ‘Extracting FPGA Image SREC’, and ‘Deleting intermediate files’. If these lines don’t appear on the windows command, programming on the flash memory is not successfully set up. Please make sure Quartus II 11.1 and Nios II 11.1 IDE or later is used.



```
Info: Processing started: Mon Dec 12 14:11:52 2011
Info: Command: quartus_cpf -c tr4_hw.pof tr4_hw.hexout
Info: Quartus II 32-bit Convert_programming_file was successful. 0 errors, 0 warnings
Info: Peak virtual memory: 378 megabytes
Info: Processing ended: Mon Dec 12 14:12:27 2011
Info: Elapsed time: 00:00:35
Info: Total CPU time (on all processors): 00:00:34

Extracting Option bits SREC
Extracting FPGA Image SREC
Deleting intermediate files
Modify tr4_hw.map.flash file ok.

Load tr4_default_flash_loader file into FPGA, please wait ...

Info: *****
Info: Running Quartus II 32-bit Programmer
Info: Version 11.1 Build 173 11/01/2011 SJ Full Version
Info: Copyright (C) 1991-2011 Altera Corporation. All rights reserved.
Info: Your use of Altera Corporation's design tools, logic functions
Info: and other software and tools, and its AMPP partner logic
Info: functions, and any output files from any of the foregoing
Info: (including device programming or simulation files), and any
```

Figure 2-6 Loading .sof File

6. Erasing Flash.

```

c:\ Nios II EDS 11.1 [gcc3]
Info: applicable agreement for further details.
Info: Processing started: Mon Dec 12 14:23:26 2011
Info: Command: quartus_pgm -c USB-Blaster[USB-0] -m jtag -o p;tr4_default_flash_loader.sof
Info <213045>: Using programming cable "USB-Blaster [USB-0]"
Info <213011>: Using programming file tr4_default_flash_loader.sof with checksum 0x079EA74D for device EP4SGX230KF40Q1
Info <209060>: Started Programmer operation at Mon Dec 12 14:23:35 2011
Info <209016>: Configuring device index 1
Info <209017>: Device 1 contains JTAG ID code 0x024090DD
Info <209007>: Configuration succeeded -- 1 device(s) configured
Info <209011>: Successfully performed operation(s)
Info <209061>: Ended Programmer operation at Mon Dec 12 14:23:56 2011
Info: Quartus II 32-bit Programmer was successful. 0 errors, 0 warnings
Info: Peak virtual memory: 341 megabytes
Info: Processing ended: Mon Dec 12 14:23:56 2011
Info: Elapsed time: 00:00:30
Info: Total CPU time (on all processors): 00:00:06

Erase flash, please wait a few minutes ...

Using cable "USB-Blaster [USB-0]", device 1, instance 0x00
Resetting and pausing target processor: OK
Checksums took 6.4s
00100000 < 7%>: Erasing

```

Figure 2-7 Erasing Flash

7. Programming Flash.

```

c:\ Nios II EDS 11.1 [gcc3]
Info: Processing started: Mon Dec 12 14:29:00 2011
Info: Command: quartus_pgm -c USB-Blaster[USB-0] -m jtag -o p;tr4_default_flash_loader.sof
Info <213045>: Using programming cable "USB-Blaster [USB-0]"
Info <213011>: Using programming file tr4_default_flash_loader.sof with checksum 0x079EA74D for device EP4SGX230KF40Q1
Info <209060>: Started Programmer operation at Mon Dec 12 14:29:06 2011
Info <209016>: Configuring device index 1
Info <209017>: Device 1 contains JTAG ID code 0x024090DD
Info <209007>: Configuration succeeded -- 1 device(s) configured
Info <209011>: Successfully performed operation(s)
Info <209061>: Ended Programmer operation at Mon Dec 12 14:29:27 2011
Info: Quartus II 32-bit Programmer was successful. 0 errors, 0 warnings
Info: Peak virtual memory: 341 megabytes
Info: Processing ended: Mon Dec 12 14:29:27 2011
Info: Elapsed time: 00:00:27
Info: Total CPU time (on all processors): 00:00:06

Program flash, please wait a few minutes ...

Using cable "USB-Blaster [USB-0]", device 1, instance 0x00
Resetting and pausing target processor: OK
Checksums took 2.3s
Erase not required
00180000 <12%>: Programming

```

Figure 2-8 Programming Flash

8. Programming complete.

```
ca Nios II EDS 11.1 [gcc3]
Info <209061>: Ended Programmer operation at Mon Dec 12 14:29:27 2011
Info: Quartus II 32-bit Programmer was successful. 0 errors, 0 warnings
Info: Peak virtual memory: 341 megabytes
Info: Processing ended: Mon Dec 12 14:29:27 2011
Info: Elapsed time: 00:00:27
Info: Total CPU time (on all processors): 00:00:06

Program flash, please wait a few minutes ...

Using cable "USB-Blaster [USB-01]", device 1, instance 0x00
Resetting and pausing target processor: OK
Checksums took 2.3s
Erase not required
Programmed 11596KB in 737.1s (15.7KB/s)
Device contents checksummed OK
Leaving target processor paused
Using cable "USB-Blaster [USB-01]", device 1, instance 0x00
Resetting and pausing target processor: OK
Checksums took 0.0s
Erase not required
Programmed 1KB in 0.0s
Device contents checksummed OK
Leaving target processor paused

Press ENTER key to continuance...
```

Figure 2-9 Programming Flash complete

2.2 Setup Elements

■ JTAG Control DIP Switch

The TR4 supports individual JTAG interfaces on each HSMC connector. This feature allows users to extend the JTAG chain to daughter cards or additional TR4s. **Before using this interface, JP7 needs to be shorted to enable the JTAG interface on all the HSMC connectors.**

The JTAG signals on each HSMC connector can be removed or included in the active JTAG chain via DIP switches. **Table 2-1** lists the position of the DIP switches and their associated interfaces.

Note that if the JTAG interface on HSMC connector is enabled, make sure that the active JTAG chain must be a closed loop or the FPGA may not be detected. Section 2.5 will give an example on how to extend the JTAG interface to a daughter card. Also, a document named *Using_Mult-TR4_system.pdf* in TR4 system CD shows how to connect the JTAG interface on two stacked TR4 boards.

Table 2-1 JTAG Control

<i>Components</i>	<i>Name</i>	<i>Description</i>	<i>Default</i>	
SW4	position 1	HSMCA_TOP	ON: HSMA TOP in-chain OFF: Bypass HSMA TOP	OFF
	position 2	HSMCB_TOP	ON: HSMB TOP in-chain OFF: Bypass HSMB TOP	OFF
	position 3	HSMCC_TOP	ON: HSMC TOP in-chain OFF: Bypass HSMC TOP	OFF
	position 4	HSMCD_TOP	ON: HSMD TOP in-chain OFF: Bypass HSMD TOP	OFF
SW5	position 1	HSMCA_BOT	ON: HSMA BOT in-chain OFF: Bypass HSMA BOT	OFF
	position 2	HSMCB_BOT	ON: HSMB BOT in-chain OFF: Bypass HSMB BOT	OFF
	position 3	HSMCC_BOT	ON: HSMC BOT in-chain OFF: Bypass HSMC BOT	OFF
	position 4	HSMCD_BOT	ON: HSMD BOT in-chain OFF: Bypass HSMD BOT	OFF
SW6	position 1	HSMCE_TOP	ON: HSME TOP in-chain OFF: Bypass HSME TOP	OFF
	position 2	HSMCF_TOP	ON: HSMF TOP in-chain OFF: Bypass HSMF TOP	OFF

2.3 Status Elements

The TR4 includes status LEDs. Please refer [Table 2-2](#) for the status of the LED indicator.

Table 2-2 LED Indicators

<i>Board Reference</i>	<i>LED name</i>	<i>Description</i>
D13	HSMC Port E present	These LEDs are lit when HSMC Port A/B/C/D/E/F have a board or cable plugged-in such that pin 160 becomes grounded.
D14	HSMC Port D present	
D15	HSMC Port A present	
D20	HSMC Port C Present	
D27	HSMC Port B Present	
D28	HSMC Port F Present	
D16	USB Blaster Circuit	This LED is lit when the USB blaster circuit transmits or receives data.
D17	MAX_LOAD	This LED is lit when the FPGA is being actively configured.

D18	MAX_ERROR	This LED is lit when the MAX II CPLD EPM2210 System Controller fails to configure the FPGA.
D19	MAX_CONF_DONE _n	This LED is lit when the FPGA is successfully configured.
D33	19V POWER	This LED is lit after the 19V adapter is plugged in
D1~D12	HSMC VCCIO_LED	These LEDs indicate the I/O standard of the HSMC ports (see Table 2-12)

2.4 General User Input/Output

■ Push-buttons

The TR4 includes six push-buttons that allow you to interact with the Stratix IV GX FPGA. Each of these buttons is debounced using a Schmitt Trigger circuit, as indicated in [Figure 2-10](#). Each push-button provides a high logic level or a low logic level when it is not pressed or pressed, respectively (active-low). [Table 2-3](#) lists the board references, signal names and their corresponding Stratix IV GX device pin numbers.

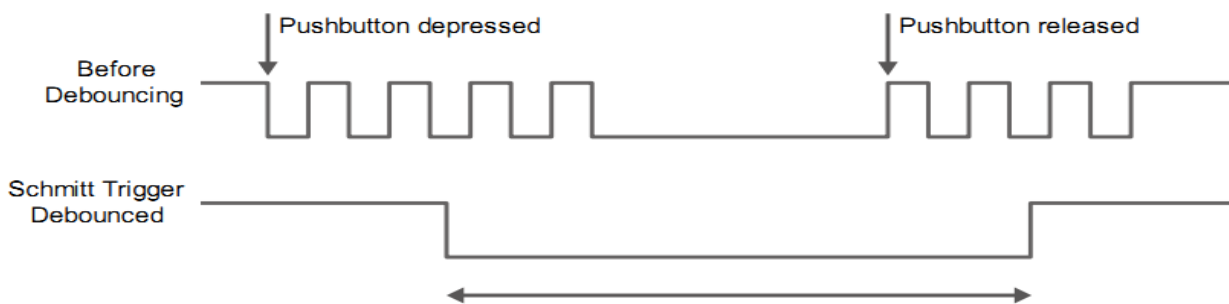

Figure 2-10 Push-button Debouncing

Table 2-3 Push-button Pin Assignments, Schematic Signal Names, and Functions

Name	Locate	Description	I/O Standard	Stratix IV GX Pin Number
PB3	BUTTON3	Low when pushed (Active-low)	1.5V	PIN_P20
PB4	BUTTON2		1.5V	PIN_A19
PB5	BUTTON1		1.5V	PIN_M19
PB6	BUTTON0		1.5V	PIN_L19

The **MAX_RSTN** push-button is used to reset the MAX II EPM2210 CPLD. The **Config** push-button can configure default code to FPGA. **Table 2-4** lists the board references, signal names and their corresponding Stratix IV GX device pin numbers.

Table 2-4 Push-button Pin Assignments, Schematic Signal Names, and Functions

<i>Name</i>	<i>Locate</i>	<i>Description</i>	<i>I/O Standard</i>	<i>EPM2210 Pin Number</i>
PB1	MAX_RSTn	MAX II reset	3.3V-VTTL	PIN_M9
PB2	CONFIG	FPGA reconfig	3.3V-VTTL	PIN_D12

■ Slide Switches

There are four slide switches on the TR4 to provide additional FPGA input control. Each switch is connected directly to a pin of the Stratix IV GX FPGA. When a slide switch is in the DOWN position or the UP position, it provides a low logic level or a high logic level (**VCCIO_HSMF** or **VCCIO_HSMA**) to the FPGA, respectively. **Table 2-5** lists the board references, signal names and their corresponding Stratix IV GX device pin numbers.

Table 2-5 Slide Switches Pin Assignments, Schematic Signal Names, and Functions

<i>Name</i>	<i>Locate</i>	<i>Description</i>	<i>I/O Standard</i>	<i>Stratix IV GX Pin Number</i>
SW0	SLIDE SW	Provides high logic level when in the UP position	VCCIO_HSMF	PIN_AH18
SW1	SLIDE SW		VCCIO_HSMF	PIN_AH19
SW2	SLIDE SW		VCCIO_HSMA	PIN_D6
SW3	SLIDE SW		VCCIO_HSMA	PIN_C6

■ LEDs

The TR4 consists of 4 user-controllable LEDs to allow status and debugging signals to be driven to the LEDs from the designs loaded into the Stratix IV GX device. Each LED is driven directly by the Stratix IV GX FPGA. The LED is turned on or off when the associated pins are driven to a low or high logic level, respectively (active-low). A list of the pin names on the FPGA that are connected to the LEDs is given in **Table 2-6**.

Table 2-6 User LEDs Pin Assignments, Schematic Signal Names, and Functions

<i>Name</i>	<i>Description</i>	<i>Description</i>	<i>I/O Standard</i>	<i>Stratix IV GX Pin Number</i>

D27	LED0	LEDs turn on when output is logic low (Active-low)	1.5V	PIN_B19
D28	LED1		1.5V	PIN_A18
D29	LED2		1.5V	PIN_D19
D30	LED3		1.5V	PIN_C19

2.5 High-Speed Mezzanine Cards

The High Speed Mezzanine Card (HSMC) interface provides a mechanism to extend the peripheral-set of an FPGA host board by means of add-on daughter cards, which can address today's high speed signaling requirements as well as low-speed device interface support. The HSMC interfaces support JTAG, clock outputs and inputs, high-speed serial I/O (transceivers), and single-ended or differential signaling. The detailed specifications of the HSMC connectors are described below:

■ 6 HSMC Connector Groups

There are ten HSMC connectors on the TR4 board are divided into 6 groups: HSMC A, HSMC B, HSMC C, HSMC D, HSMC E, and HSMC F. Each group has a male and female HSMC port on the top and bottom side of the TR4 board **except HSMC E and HSMC F**. In addition, both the male and female HSMC connector share the same I/O pins besides JTAG interface and high-speed serial I/O (transceivers).

Caution: DO NOT connect HSMC daughter cards to the backside HSMC (male) connectors. Doing so will permanently damage the on-board FPGA.

■ I/O Distribution

The HSMC connector on the TR4 includes a total of 172 pins, including 121 signal pins (120 signal pins +1 PSNTn pin), 39 power pins, and 12 ground pins. **Figure 2-11** shows the signal bank diagram of HSMC connector. Bank 1 also has dedicated JTAG, I2C bus, and clock signals. The main CMOS/LVDS interface signals, including LVDS/CMOS clocks, are found in banks 2 and 3. Both 12V and 3.3V power pins are also found in banks 2 and 3.

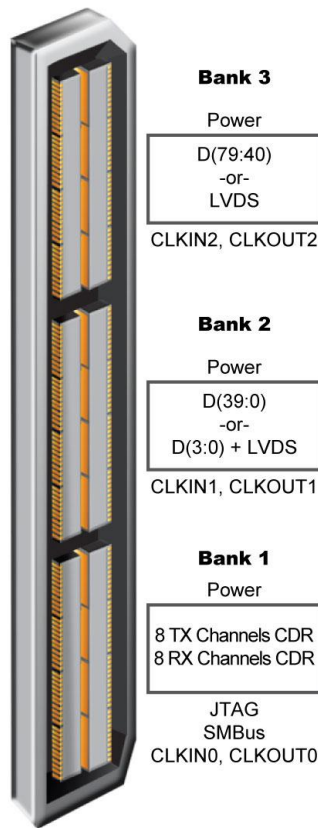

Figure 2-11 HSMC Signal Bank Diagram

Due to the limitation of FPGA bank I/O distribution and dedicated clock in/out pin numbers, there are some differences between individual HSMC connectors, listed below:

■ LVDS Interface

On the TR4 board, only HSMC ports A, B, C and D support LVDS. Each HSMC port provides 18(1) LVDS channel transceivers.

For LVDS transmitters, HSMC ports A and D support 18 true LVDS channels which can run up to 1.6Gbps. The LVDS transmitter on HSMC Port B and C contain true and emulated LVDS channels.

The emulated LVDS channels use two single-ended output buffers and external resistors as shown in [Figure 2-12](#). The associated I/O standard of these differential FPGA I/O pins in the Quartus II project should be set to LVDS_E_3R. Emulated LVDS I/O data rates can reach speeds up to 1.1Gbps. The factory default setting for the Rs resistor will be 0 ohm and the Rp resistor will not be assembled for single-ended I/O standard applications. For emulated LVDS transmitters, please solder 120 and 170 ohm resistors onto the Rs and Rp positions, respectively.

For the LVDS receivers, HSMC Port A/B/D support true LVDS receivers which can run at 1.6Gbps. Unlike HSMC ports A/D, not all the LVDS receivers in HSMC ports B/C support On-Chip termination (OCT). To use these I/Os as LVDS receivers, the user needs to solder a 100 ohm resistor for input termination as show in **Figure 2-12**.

Table 2-7 gives the detailed numbers of true and emulated LVDS interfaces of each HSMC port. Also, it lists the numbers of LVDS receivers needed to assemble external input termination resistors on each HSMC ports.

Table 2-8 shows all the external input differential resistors for LVDS receivers on HSMC Port B and C. The factory default setting is not installed.

Finally, because HSMC Port C shares FPGA I/O pins with GPIO headers, so the LVDS performance can only support a data rate of up to 500Mbps.

(1) Although the specifications of the HSMC connector defines signals D0~D3 as single-ended I/Os, D0 and D2 can be used as LVDS transmitters and D1 and D3 can be used as LVDS receivers on the TR4.

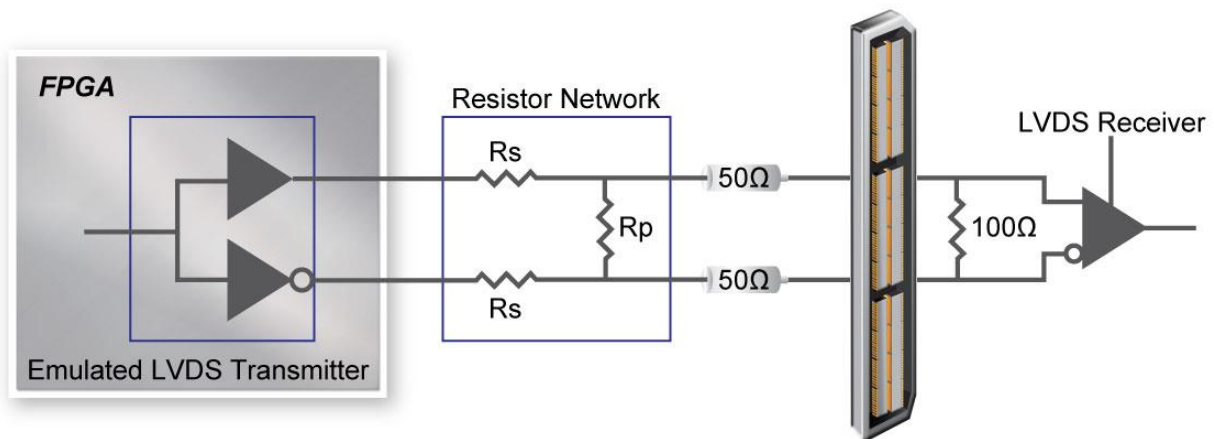

Figure 2-12 Emulated LVDS Resistor Network between FPGA and HSMC Port

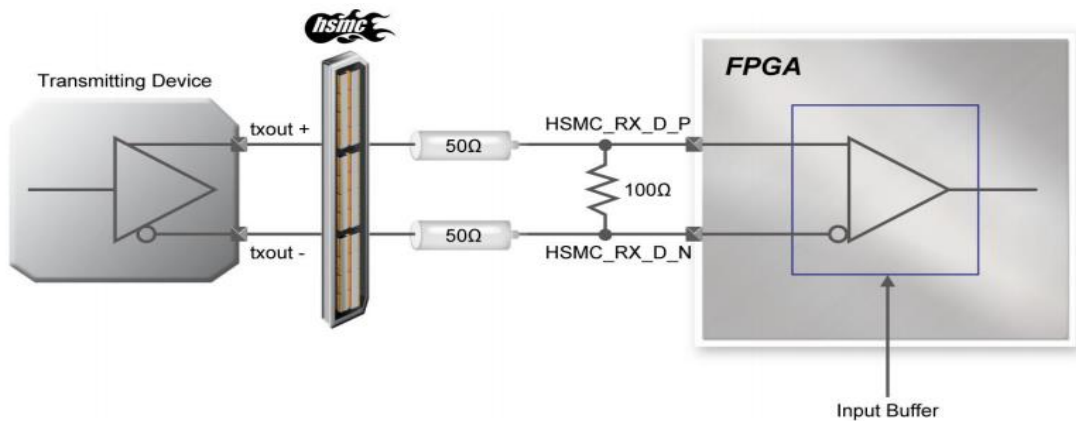

Figure 2-13 External On-Board Termination between FPGA and HSMC Port

Table 2-7 LVDS Breakdown

	<i>HSMA</i>	<i>HSMB</i>	<i>HSMC</i>	<i>HSMD</i>	<i>HSME</i>	<i>HSMF</i>
True LVDS Transmitters	18	10	9	18	9	NA
Emulated LVDS Transmitters	0	8	9	0	NA	NA
Supported with OCT	18	11	9	18	9	NA
Needed External Input Termination Resistors.	0	7	9	0	NA	NA

Table 2-8 Distribution of the Differential Termination Resistors for HSMC Connector

<i>HSMC Differential Net</i>	<i>Reference name of the differential termination resistor</i>
HSMB_RX_p[11]	R333
HSMB_RX_p[12]	R318
HSMB_RX_p[13]	R312
HSMB_RX_p[14]	R311
HSMB_RX_p[15]	R303
HSMB_RX_p[16]	R315
HSMB_D[1]	R332
HSMC_RX_p[0]	R314
HSMC_RX_p[1]	R316
HSMC_RX_p[2]	R330
HSMC_RX_p[3]	R341
HSMC_RX_p[4]	R329
HSMC_RX_p[5]	R328
HSMC_RX_p[6]	R309

HSMC_RX_p[7]	R306
HSMC_D[1]	R310

■ High-speed Serial I/O (transceiver) Interface

There are 8 CDR transceiver channels located on the **top side** of HSMC ports A and E, respectively. Each CDR transceiver can run up to 6.5Gbps.

■ Clock Interface

Due to the limitation of the FPGA clock input pin numbers, not all the HSMC ports have same clock interface. **Table 2-9** shows the FPGA clock input pin placement on each HSMC port.

In addition, since FPGA dedicated clock input pins (CLK[1,3,8,10]), or corner PLL clocks don't support On-Chip differential termination, please solder input termination resistors on R299 and R300, respectively, when using HSMC_CLKIN_p2/n2 and HSMA_CLKIN_p2/n2 as LVDS signals.

Table 2-9 HSMC clock interface distribution

<i>HSMC Clock in/out pin</i>	<i>FPGA Clock Input Pin Placement</i>					
	<i>HSMA</i>	<i>HSMB</i>	<i>HSMC</i>	<i>HSMD</i>	<i>HSME</i>	<i>HSMF</i>
CLKIN0	I/O	I/O	I/O	CLK1n	I/O	CLK5p
CLKIN_p1	CLK9p	I/O	CLK2p	CLK0p	CLK11p	CLK6p
CLKIN_n1	CLK9n	I/O	CLK2n	CLK0n	CLK11n	CLK6n
CLKIN_p2	CLK8p	I/O	CLK3p	I/O	CLK10p	CLK4p
CLKIN_n2	CLK8n	I/O	CLK3n	I/O	CLK10n	CLK4n

■ I2C Interface

The I2C bus on the HSMC connectors is separated into two groups. HSMC Port A, B, and C share the same I2C interface. HSMC ports D, E, and F share the other I2C bus. **Table 2-10** lists the detailed distribution.

Table 2-10 HSMC I2C Group

HSMC A/B/C I2C			
Schematic Signal Name	Description	I/O Standard	Stratix IV GX Pin Number
HSMB_SCL	<i>HSMC A/B/C I2C clock signal</i>	2.5 V (1)	AE16
HSMB_SDA	<i>HSMC A/B/C I2C data signal</i>	2.5 V(1)	AF16
HSMC D/E/F I2C			
Schematic Signal Name	Description	I/O Standard	Stratix IV GX Pin Number
HSMD_SCL	<i>HSMC D/E/F I2C clock signal</i>	1.5V(1)	G21
HSMD_SDA	<i>HSMC D/E/F I2C data signal</i>	1.5V(1)	F21

(1) The I2C I/O on the TR4 HSMC connector is defined with 3.3V.

There is a level translator between FPGA and HSMC connector to translate FPGA 2.5V or 1.5V I/O to 3.3V. The signals above are also connected to the level translator. When these signals are used as general purpose I/O, the maximum data rate is 60Mbps.

■ I/O through the Level Translator

There is a pin named **HSMD_OUT0** on HSMC Port D which is connected to an FPGA 1.5V I/O standard bank. To meet the I/O standard of adjustable specification, a level translator is used between the FPGA and HSMC Port D on this net. Thus, the maximum data rate of this pin is 60Mbps due to the limitations of the level translator.

■ HSMC Port C Shared Bus with GPIO

The HSMC Port C shares the same FPGA I/O pins with the GPIO expansion headers (JP9, JP10). Hence none of the combinations above are allowed to be used simultaneously.

■ Power Supply

The TR4 board provides 12V DC and 3.3V DC power through HSMC ports. **Table 2-11** indicates the maximum power consumption for all HSMC ports. Please note that this table shows the total max current limit for all six ports, not just for one.

Also, the 12V DC and 3.3V DC power supplies from the HSMC ports have fuses for protection. Users who don't need the power from the HSMC can remove these fuses to cut the power on connector.

CAUTION. Before powering on the TR4 board with a daughter card, please check to see if there is a short circuit between the power pins and FPGA I/O.

Table 2-11 Power Supply of the HSMC

<i>Supplied Voltage</i>	<i>Max. Current Limit</i>
12V	2A
3.3V	3A

■ Adjustable I/O Standards

The FPGA I/O standards of the HSMC ports can be adjusted by configuring the header position. Each port can be individually adjusted to 1.5V, 1.8V, 2.5V or 3.0V via jumpers on the top-right corner of TR4 board. **Figure 2-14** depicts the position of the jumpers and their associated I/O standards. Users can use 2-pin jumpers to configure the I/O standard by choosing the associated positions on the header.

Finally, there are LEDs on the top-right corner of TR4 board to indicate the I/O standard of each HSMC port, as shown in **Table 2-12**. For example, LEDs D11 and D12 will be turned on and off, respectively, when the I/O Standard of HSMC Port A is set to 2.5V.

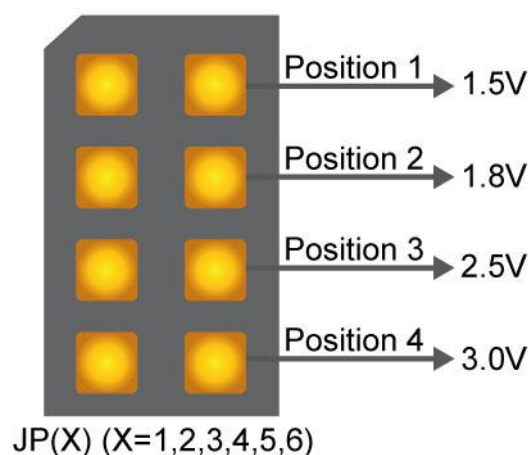

Figure 2-14 HSMC I/O Configuration Header

Table 2-12 HSMC IO Standard Indicators

	HSMA		HSMB		HSMC		HSMD		HSME		HSMF	
	D11	D12	D9	D10	D7	D8	D5	D6	D3	D4	D1	D2
1.5V	OFF	OFF	OFF	OFF	OFF	OFF	OFF	OFF	OFF	OFF	OFF	OFF
1.8V	OFF	ON	OFF	ON	OFF	ON	OFF	ON	OFF	ON	OFF	ON
2.5V	ON	OFF	ON	OFF	ON	OFF	ON	OFF	ON	OFF	ON	OFF
3.0V	ON	ON	ON	ON	ON	ON	ON	ON	ON	ON	ON	ON

(1) *Users who connect a daughter card onto the HSMC ports need to pay close attention to the I/O standard between TR4 HSMC connector pins and daughter card system. For example, if the I/O standard of HSMC pins on TR4 board is set to 1.8V, a daughter card with 3.3V or 2.5V I/O standard may not work properly on TR4 board due to I/O standard mismatch. When using custom or third-party HSMC daughter cards, make sure that all the pin locations are aligned to prevent shorts.*

■ Using THCB-HMF2 Adapter Card

The purpose of the HSMC Height Extension Male to Female card (THCB-HMF2) included in the TR4 kit package is to increase the height of the HSMC (Port C and D) connector to avoid any obstruction that might take place as a HSMC daughter card is connected. The THCB-HMF2 adapter card can be connected to either ports of the HSMC connector shown in [Figure 2-15](#). There are numerous adapter cards that are supported by the TR4, such as loopback and differential transmission adapters. For more detailed information about these adapter cards, please refer to *HSMC_adapter_card.pdf* which can be found in TR4 system CD.

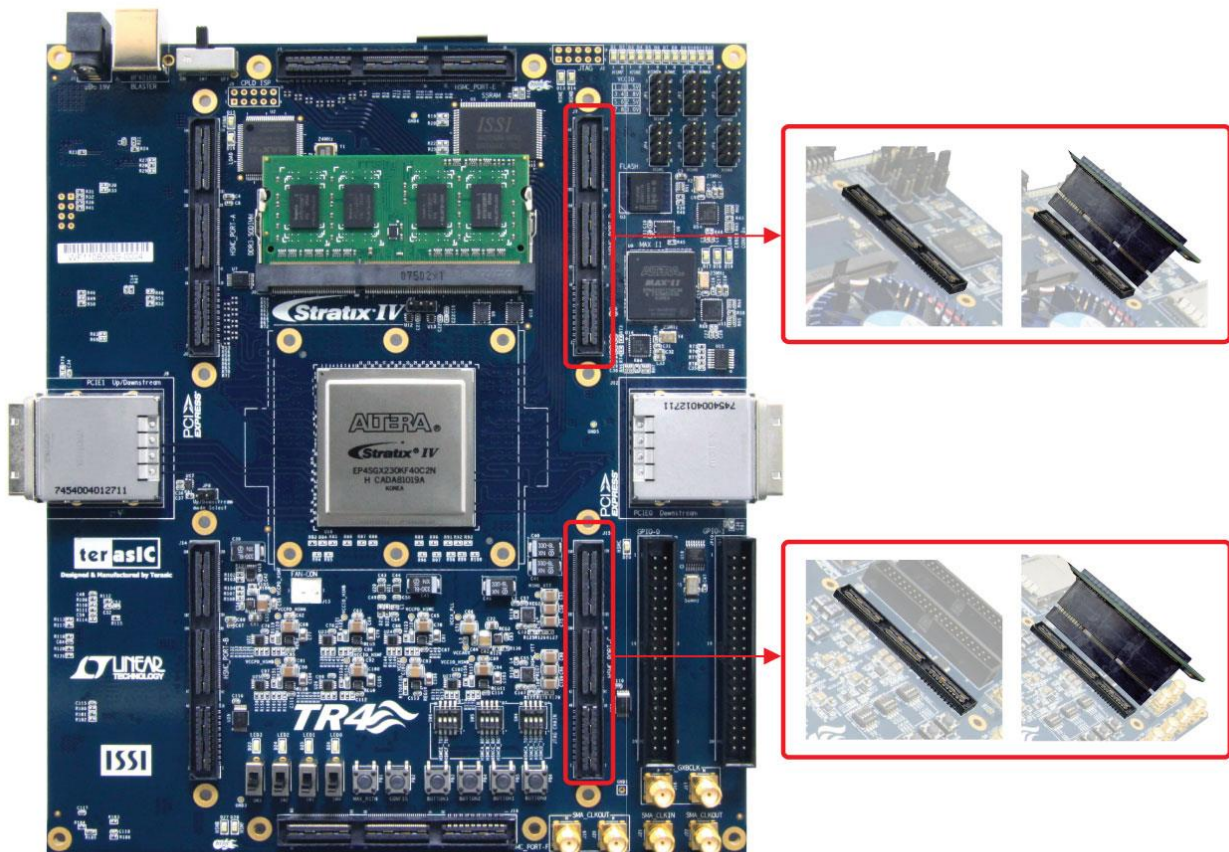

Figure 2-15 Connection between HMF2 Adapter Card and HSMC

■ JTAG Chain on HSMC

The JTAG chain on the HSMC can be activated through the three 4-position DIP switches (SW4, SW5, and SW6). **Table 2-1** in section 2.2 gives a detailed description of the positions of the DIP switches and their associated interfaces. The HSMC connectors on the top side of TR4 board are controlled by SW4 and SW6. SW5 is used to control the HSMC JTAG chain on the bottom-side of the TR4. Only when multiple TR4s are stacked should the boards use this switch. A document titled *Using_Multi-TR4_system.pdf* in the TR4 system CD will give an example to demonstrate how to set SW5 to connect JTAG chains together for multiple TR4 boards. Finally, before using the JTAG interface on HSMC connector, please short JP7 in order to enable the HSMC JTAG interface.

The following will describe how to configure the JTAG interface of HSMC connector on the top-side of the TR4.

If there is no connection established on the HSMC connectors, the 4-position DIP switch (SW4 or SW6) should be set to ‘Off’, so the JTAG signals on the HSMC connectors are bypassed illustrated in **Figure 2-16**.

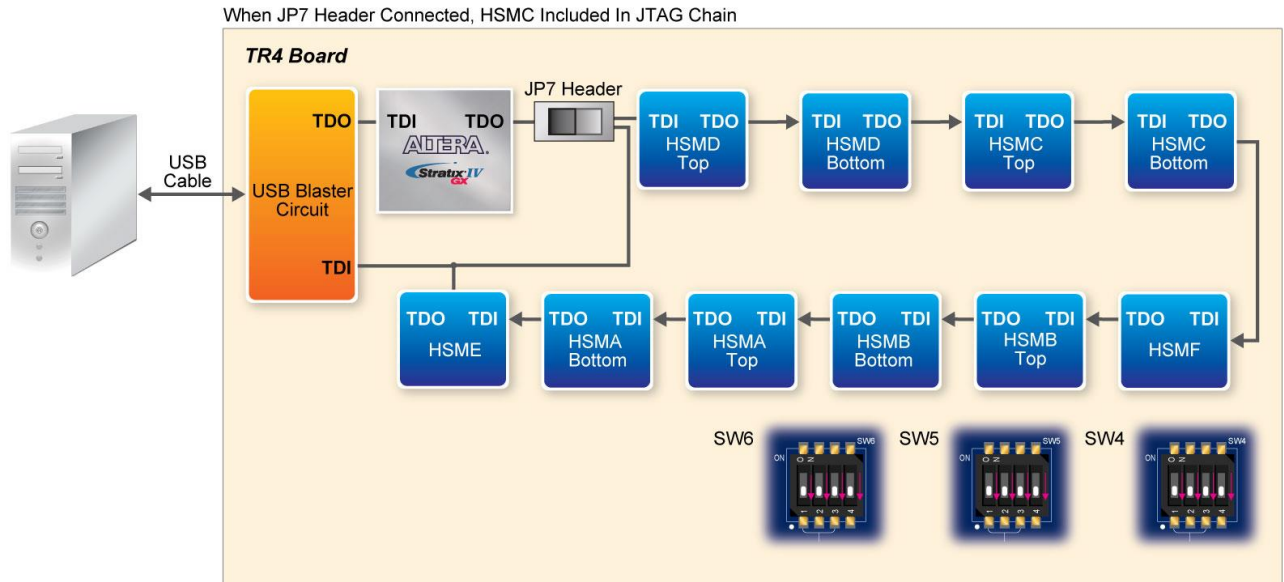

Figure 2-16 JTAG Chain for a Standalone TR4

If the HSMC-based daughter card connected to the HSMC connector uses the JTAG interface, the 4-position DIP switch (SW4 or SW6) should be set to ‘On’ according to the HSMC port used. In this case, from **Figure 2-17** HSMC Port D is used so position 4 of the SW4 switch is set to ‘On’. Similarly, if the JTAG interface isn’t used on the HSMC-based daughter card, position 4 of SW4 is set to ‘Off’, thus bypassing the JTAG signals as shown in **Figure 2-18**.

■ Multi-FPGA High-Capacity Platforms through HSMC

The TR4 offers a selection of two Stratix IV GX devices, EP4SGX230 and EPSGX530, which offer logic elements (LEs) up to 228,000 and 531,200, respectively, to provide the flexibility for users to select a suitable device. In situations where users' design exceeds the capacity of the FPGA, the HSMC interface can be used to connect to other FPGA system boards creating a multi-FPGA scalable system. Users can stack two TR4s as shown in **Figure 2-19**. Another option is to use a Samtec high-speed cable to connect two TR4 boards (See **Figure 2-20**) to expand your system. For more information on how to use multi-TR4 systems, please refer to *Using_Mult-TR4_system.pdf*, which can be found on the TR4 System CD.



Figure 2-19 Two Stacked TR4 Boards

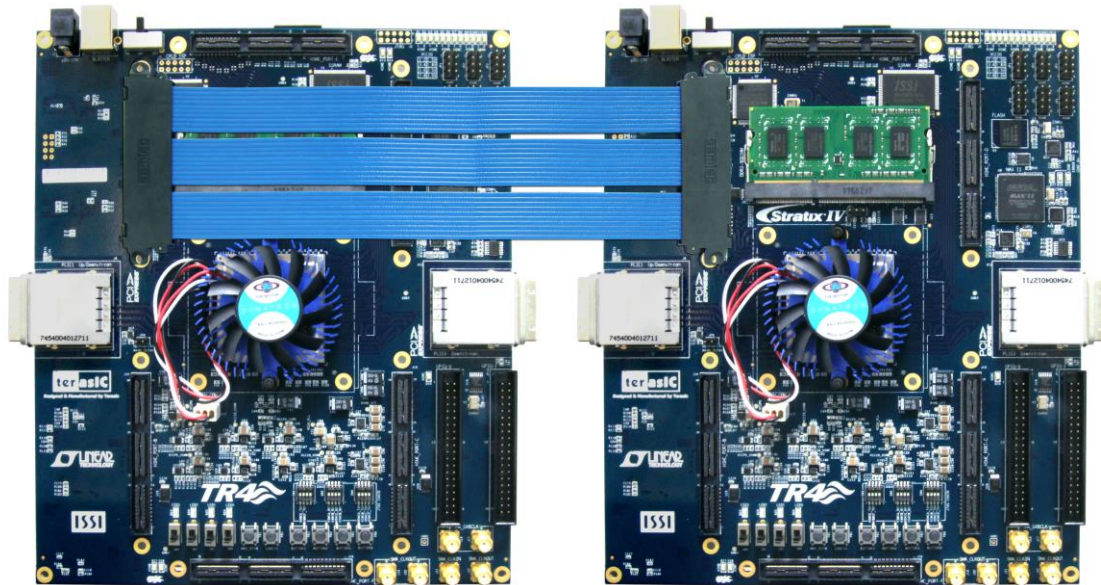

Figure 2-20 Two TR4 Boards Connected via HSMC Cable

2.6 GPIO Expansion Headers

The TR4 consists of two 40-pin expansion headers as shown in **Figure 2-21**. Each header has 36 I/O pins connected to the Stratix IV GX FPGA, with the other 4 pins providing 5V (VCC5) DC, 3.3V (VCC33) DC, and two GND pins.

GPIO 0 and GPIO 1 share pins with HSMC Port C. The I/O standards of the GPIO headers are the same as HSMC Port C, which can be configured between 1.5, 1.8, 2.5 and 3.0V.



Figure 2-21 Pin Distribution of the GPIO Expansion Headers

Finally, **Figure 2-22** shows the connections between the GPIO expansion headers and Stratix IV GX.



Figure 2-22 Connection between the GPIO Expansion Headers and Stratix IV GX

The information about mapping of the FPGA pin assignments to the GPIO0 and GPIO1 connectors, please refer [Table 2-13](#) and [Table 2-14](#).

Table 2-13 GPIO Expansion Header (JP9) Pin Assignments, Schematic Signal Names, and Functions

Board Reference (JP9)	Schematic Signal Name	Description	I/O Standard	Stratix IV GX Pin Number
1	GPIO0_D0	GPIO Expansion 0 IO[0](Clock In)	Depends on I/O Standard of HSMC Port C	PIN_AF34
2	GPIO0_D1	GPIO Expansion 0 IO[1]		PIN_AG34
3	GPIO0_D2	GPIO Expansion 0 IO[2](Clock In)		PIN_AE35
4	GPIO0_D3	GPIO Expansion 0 IO[3]		PIN_AG35
5	GPIO0_D4	GPIO Expansion 0 IO[4]		PIN_AC31
6	GPIO0_D5	GPIO Expansion 0 IO[5]		PIN_AH32
7	GPIO0_D6	GPIO Expansion 0 IO[6]		PIN_AC32
8	GPIO0_D7	GPIO Expansion 0 IO[7]		PIN_AH33
9	GPIO0_D8	GPIO Expansion 0 IO[8]		PIN_AH34
10	GPIO0_D9	GPIO Expansion 0 IO[9]		PIN_AJ34
13	GPIO0_D10	GPIO Expansion 0 IO[10]		PIN_AH35
14	GPIO0_D11	GPIO Expansion 0 IO[11]		PIN_AJ35
15	GPIO0_D12	GPIO Expansion 0 IO[12]		PIN_AK34
16	GPIO0_D13	GPIO Expansion 0 IO[13]		PIN_AL34
17	GPIO0_D14	GPIO Expansion 0 IO[14]		PIN_AK35
18	GPIO0_D15	GPIO Expansion 0 IO[15]		PIN_AL35
19	GPIO0_D16	GPIO Expansion 0 IO[16]		PIN_AM34
20	GPIO0_D17	GPIO Expansion 0 IO[17]		PIN_AN34

21	GPIO0_D18	GPIO Expansion 0 IO[18]	Depends on I/O Standard of HSMC Port C	PIN_AM35
22	GPIO0_D19	GPIO Expansion 0 IO[19]		PIN_AN35
23	GPIO0_D20	GPIO Expansion 0 IO[20]		PIN_AJ32
24	GPIO0_D21	GPIO Expansion 0 IO[21]		PIN_AJ26
25	GPIO0_D22	GPIO Expansion 0 IO[22]		PIN_AK33
26	GPIO0_D23	GPIO Expansion 0 IO[23]		PIN_AK26
27	GPIO0_D24	GPIO Expansion 0 IO[24]		PIN_AF25
28	GPIO0_D25	GPIO Expansion 0 IO[25]		PIN_AV29
31	GPIO0_D26	GPIO Expansion 0 IO[26]		PIN_AG25
32	GPIO0_D27	GPIO Expansion 0 IO[27]		PIN_AW30
33	GPIO0_D28	GPIO Expansion 0 IO[28]		PIN_AV32
34	GPIO0_D29	GPIO Expansion 0 IO[29]		PIN_AT28
35	GPIO0_D30	GPIO Expansion 0 IO[30]		PIN_AW32
36	GPIO0_D31	GPIO Expansion 0 IO[31]		PIN_AU28
37	GPIO0_D32	GPIO Expansion 0 IO[32]		PIN_AV28
38	GPIO0_D33	GPIO Expansion 0 IO[33]		PIN_AP28
39	GPIO0_D34	GPIO Expansion 0 IO[34]		PIN_AW29
40	GPIO0_D35	GPIO Expansion 0 IO[35]		PIN_AR28

Table 2-14 GPIO Expansion Header (JP10) Pin Assignments, Schematic Signal Names, and Functions

<i>Board Reference (JP10)</i>	<i>Schematic Signal Name</i>	<i>Description</i>	<i>I/O Standard</i>	<i>Stratix IV GX Pin Number</i>
1	GPIO1_D0	GPIO Expansion 1 IO[0]	Depends on I/O Standard of HSMC Port C	PIN_AB27
2	GPIO1_D1	GPIO Expansion 1 IO[1]		PIN_AE25
3	GPIO1_D2	GPIO Expansion 1 IO[2]		PIN_AB28
4	GPIO1_D3	GPIO Expansion 1 IO[3]		PIN_AD25
5	GPIO1_D4	GPIO Expansion 1 IO[4]		PIN_AP27
6	GPIO1_D5	GPIO Expansion 1 IO[5]		PIN_AU29
7	GPIO1_D6	GPIO Expansion 1 IO[6]		PIN_AN27
8	GPIO1_D7	GPIO Expansion 1 IO[7]		PIN_AT29
9	GPIO1_D8	GPIO Expansion 1 IO[8]		PIN_AL25
10	GPIO1_D9	GPIO Expansion 1 IO[9]		PIN_AW33
13	GPIO1_D10	GPIO Expansion 1 IO[10]		PIN_AP26
14	GPIO1_D11	GPIO Expansion 1 IO[11]		PIN_AW34
15	GPIO1_D12	GPIO Expansion 1 IO[12]		PIN_AW31
16	GPIO1_D13	GPIO Expansion 1 IO[13]		PIN_AH24
17	GPIO1_D14	GPIO Expansion 1 IO[14]		PIN_AV31
18	GPIO1_D15	GPIO Expansion 1 IO[15]		PIN_AG24
19	GPIO1_D16	GPIO Expansion 1 IO[16]		PIN_AL27
20	GPIO1_D17	GPIO Expansion 1 IO[17]		PIN_AW27
21	GPIO1_D18	GPIO Expansion 1 IO[18]		PIN_AH26
22	GPIO1_D19	GPIO Expansion 1 IO[19]		PIN_AW28

23	GPIO1_D20	GPIO Expansion 1 IO[20]	Depends on I/O Standard of HSMC Port C	PIN_AK27
24	GPIO1_D21	GPIO Expansion 1 IO[21]		PIN_AD30
25	GPIO1_D22	GPIO Expansion 1 IO[22]		PIN_AE24
26	GPIO1_D23	GPIO Expansion 1 IO[23]		PIN_AD31
27	GPIO1_D24	GPIO Expansion 1 IO[24]		PIN_AB30
28	GPIO1_D25	GPIO Expansion 1 IO[25]		PIN_AE30
31	GPIO1_D26	GPIO Expansion 1 IO[26]		PIN_AB31
32	GPIO1_D27	GPIO Expansion 1 IO[27]		PIN_AE31
33	GPIO1_D28	GPIO Expansion 1 IO[28]		PIN_AG31
34	GPIO1_D29	GPIO Expansion 1 IO[29]		PIN_AE28
35	GPIO1_D30	GPIO Expansion 1 IO[30]		PIN_AG32
36	GPIO1_D31	GPIO Expansion 1 IO[31]		PIN_AE29
37	GPIO1_D32	GPIO Expansion 1 IO[32]		PIN_AF29
38	GPIO1_D33	GPIO Expansion 1 IO[33]		PIN_AD28
39	GPIO1_D34	GPIO Expansion 1 IO[34]		PIN_AG30
40	GPIO1_D35	GPIO Expansion 1 IO[35]		PIN_AD29

2.7 DDR3 SO-DIMM

One DDR3 SO-DIMM socket is provided as a flexible and efficient form-factor volatile memory for user applications. The DDR3 SODIMM socket is wired to support a maximum capacity of 8GB with a 64-bit data bus. Using differential DQS signaling for the DDR3 SDRAM interfaces, it is capable of running at up to 533MHz memory clock for a maximum theoretical bandwidth up to 68Gbps. **Figure 2-23** shows the connections between the DDR3 SO-DIMM socket and Stratix IV GX device. The information about mapping of the FPGA pin assignments to the DDR3 SODIMM connectors, please refer to **Table 2-15**.

Table 2-15 DDR3 SODIMM Pin Assignments, Schematic Signal Names, and Functions

Schematic			Stratix IV GX
Signal Name	Description	I/O Standard	Pin Number
mem_addr [0]	DDR3 ADDRess [0]	SSTL-15 Class I	PIN_N23
mem_addr [1]	DDR3 ADDRess [1]	SSTL-15 Class I	PIN_C22
mem_addr [2]	DDR3 ADDRess [2]	SSTL-15 Class I	PIN_M22
mem_addr [3]	DDR3 ADDRess [3]	SSTL-15 Class I	PIN_D21
mem_addr [4]	DDR3 ADDRess [4]	SSTL-15 Class I	PIN_P24
mem_addr [5]	DDR3 ADDRess [5]	SSTL-15 Class I	PIN_A24
mem_addr [6]	DDR3 ADDRess [6]	SSTL-15 Class I	PIN_M21
mem_addr [7]	DDR3 ADDRess [7]	SSTL-15 Class I	PIN_D17

mem_addr [8]	DDR3 ADDRess [8]	SSTL-15 Class I	PIN_A25
mem_addr [9]	DDR3 ADDRess [9]	SSTL-15 Class I	PIN_N25
mem_addr [10]	DDR3 ADDRess [10]	SSTL-15 Class I	PIN_C24
mem_addr [11]	DDR3 ADDRess [11]	SSTL-15 Class I	PIN_N21
mem_addr [12]	DDR3 ADDRess [12]	SSTL-15 Class I	PIN_M25
mem_addr [13]	DDR3 ADDRess [13]	SSTL-15 Class I	PIN_K26
mem_addr [14]	DDR3 ADDRess [14]	SSTL-15 Class I	PIN_F16
mem_addr [15]	DDR3 ADDRess [15]	SSTL-15 Class I	PIN_R20
mem_ba[0]	DDR3 Bank ADDRess [0]	SSTL-15 Class I	PIN_B26
mem_ba[1]	DDR3 Bank ADDRess [1]	SSTL-15 Class I	PIN_A29
mem_ba[2]	DDR3 Bank ADDRess [2]	SSTL-15 Class I	PIN_R24
mem_cas_n	DDR3 Column ADDRess Strobe	SSTL-15 Class I	PIN_L26
mem_cke[0]	Clock Enable pin 0 for DDR3	SSTL-15 Class I	PIN_P25
mem_cke[1]	Clock Enable pin 1 for DDR3	SSTL-15 Class I	PIN_M16
mem_ck[0]	Clock p0 for DDR3	Differential 1.5-V SSTL Class I	PIN_K27
mem_ck[1]	Clock p1 for DDR3	Differential 1.5-V SSTL Class I	PIN_L25
mem_ck_n[0]	Clock n0 for DDR3	Differential 1.5-V SSTL Class I	PIN_J27
mem_ck_n[1]	Clock n1 for DDR3	Differential 1.5-V SSTL Class I	PIN_K28
mem_cs_n[0]	DDR3 Chip Select [0]	SSTL-15 Class I	PIN_D23
mem_cs_n[1]	DDR3 Chip Select [1]	SSTL-15 Class I	PIN_G28
mem_dm[0]	DDR3 Data Mask [0]	SSTL-15 Class I	PIN_G16
mem_dm[1]	DDR3 Data Mask [1]	SSTL-15 Class I	PIN_N16
mem_dm[2]	DDR3 Data Mask [2]	SSTL-15 Class I	PIN_P23
mem_dm[3]	DDR3 Data Mask [3]	SSTL-15 Class I	PIN_B29
mem_dm[4]	DDR3 Data Mask [4]	SSTL-15 Class I	PIN_H28
mem_dm[5]	DDR3 Data Mask [5]	SSTL-15 Class I	PIN_E17
mem_dm[6]	DDR3 Data Mask [6]	SSTL-15 Class I	PIN_C26
mem_dm[7]	DDR3 Data Mask [7]	SSTL-15 Class I	PIN_E23
mem_dq[0]	DDR3 Data [0]	SSTL-15 Class I	PIN_G15
mem_dq[1]	DDR3 Data [1]	SSTL-15 Class I	PIN_F15
mem_dq[2]	DDR3 Data [2]	SSTL-15 Class I	PIN_C16
mem_dq[3]	DDR3 Data [3]	SSTL-15 Class I	PIN_B16
mem_dq[4]	DDR3 Data [4]	SSTL-15 Class I	PIN_G17
mem_dq[5]	DDR3 Data [5]	SSTL-15 Class I	PIN_A16

mem_dq[6]	DDR3 Data [6]	SSTL-15 Class I	PIN_D16
mem_dq[7]	DDR3 Data [7]	SSTL-15 Class I	PIN_E16
mem_dq[8]	DDR3 Data [8]	SSTL-15 Class I	PIN_N17
mem_dq[9]	DDR3 Data [9]	SSTL-15 Class I	PIN_M17
mem_dq[10]	DDR3 Data [10]	SSTL-15 Class I	PIN_K17
mem_dq[11]	DDR3 Data [11]	SSTL-15 Class I	PIN_L16
mem_dq[12]	DDR3 Data [12]	SSTL-15 Class I	PIN_P16
mem_dq[13]	DDR3 Data [13]	SSTL-15 Class I	PIN_P17
mem_dq[14]	DDR3 Data [14]	SSTL-15 Class I	PIN_J17
mem_dq[15]	DDR3 Data [15]	SSTL-15 Class I	PIN_H17
mem_dq[16]	DDR3 Data [16]	SSTL-15 Class I	PIN_N22
mem_dq[17]	DDR3 Data [17]	SSTL-15 Class I	PIN_M23
mem_dq[18]	DDR3 Data [18]	SSTL-15 Class I	PIN_J25
mem_dq[19]	DDR3 Data [19]	SSTL-15 Class I	PIN_M24
mem_dq[20]	DDR3 Data [20]	SSTL-15 Class I	PIN_R22
mem_dq[21]	DDR3 Data [21]	SSTL-15 Class I	PIN_P22
mem_dq[22]	DDR3 Data [22]	SSTL-15 Class I	PIN_K24
mem_dq[23]	DDR3 Data [23]	SSTL-15 Class I	PIN_J24
mem_dq[24]	DDR3 Data [24]	SSTL-15 Class I	PIN_A27
mem_dq[25]	DDR3 Data [25]	SSTL-15 Class I	PIN_A28
mem_dq[26]	DDR3 Data [26]	SSTL-15 Class I	PIN_C29
mem_dq[27]	DDR3 Data [27]	SSTL-15 Class I	PIN_C30
mem_dq[28]	DDR3 Data [28]	SSTL-15 Class I	PIN_C27
mem_dq[29]	DDR3 Data [29]	SSTL-15 Class I	PIN_D27
mem_dq[30]	DDR3 Data [30]	SSTL-15 Class I	PIN_A31
mem_dq[31]	DDR3 Data [31]	SSTL-15 Class I	PIN_B31
mem_dq[32]	DDR3 Data [32]	SSTL-15 Class I	PIN_G27
mem_dq[33]	DDR3 Data [33]	SSTL-15 Class I	PIN_G29
mem_dq[34]	DDR3 Data [34]	SSTL-15 Class I	PIN_F28
mem_dq[35]	DDR3 Data [35]	SSTL-15 Class I	PIN_F27
mem_dq[36]	DDR3 Data [36]	SSTL-15 Class I	PIN_E28
mem_dq[37]	DDR3 Data [37]	SSTL-15 Class I	PIN_D28
mem_dq[38]	DDR3 Data [38]	SSTL-15 Class I	PIN_H26
mem_dq[39]	DDR3 Data [39]	SSTL-15 Class I	PIN_J26
mem_dq[40]	DDR3 Data [40]	SSTL-15 Class I	PIN_F19

mem_dq[41]	DDR3 Data [41]	SSTL-15 Class I	PIN_G19
mem_dq[42]	DDR3 Data [42]	SSTL-15 Class I	PIN_F20
mem_dq[43]	DDR3 Data [43]	SSTL-15 Class I	PIN_G20
mem_dq[44]	DDR3 Data [44]	SSTL-15 Class I	PIN_C17
mem_dq[45]	DDR3 Data [45]	SSTL-15 Class I	PIN_F17
mem_dq[46]	DDR3 Data [46]	SSTL-15 Class I	PIN_C18
mem_dq[47]	DDR3 Data [47]	SSTL-15 Class I	PIN_D18
mem_dq[48]	DDR3 Data [48]	SSTL-15 Class I	PIN_D25
mem_dq[49]	DDR3 Data [49]	SSTL-15 Class I	PIN_C25
mem_dq[50]	DDR3 Data [50]	SSTL-15 Class I	PIN_G24
mem_dq[51]	DDR3 Data [51]	SSTL-15 Class I	PIN_G25
mem_dq[52]	DDR3 Data [52]	SSTL-15 Class I	PIN_B25
mem_dq[53]	DDR3 Data [53]	SSTL-15 Class I	PIN_A26
mem_dq[54]	DDR3 Data [54]	SSTL-15 Class I	PIN_D26
mem_dq[55]	DDR3 Data [55]	SSTL-15 Class I	PIN_F24
mem_dq[56]	DDR3 Data [56]	SSTL-15 Class I	PIN_F23
mem_dq[57]	DDR3 Data [57]	SSTL-15 Class I	PIN_G23
mem_dq[58]	DDR3 Data [58]	SSTL-15 Class I	PIN_J22
mem_dq[59]	DDR3 Data [59]	SSTL-15 Class I	PIN_H22
mem_dq[60]	DDR3 Data [60]	SSTL-15 Class I	PIN_K22
mem_dq[61]	DDR3 Data [61]	SSTL-15 Class I	PIN_D22
mem_dq[62]	DDR3 Data [62]	SSTL-15 Class I	PIN_G22
mem_dq[63]	DDR3 Data [63]	SSTL-15 Class I	PIN_E22
mem_dqs[0]	DDR3 Data Strobe p[0]	Differential 1.5-V SSTL Class I	PIN_D15
mem_dqs[1]	DDR3 Data Strobe p[1]	Differential 1.5-V SSTL Class I	PIN_K16
mem_dqs[2]	DDR3 Data Strobe p[2]	Differential 1.5-V SSTL Class I	PIN_L23
mem_dqs[3]	DDR3 Data Strobe p[3]	Differential 1.5-V SSTL Class I	PIN_C28
mem_dqs[4]	DDR3 Data Strobe p[4]	Differential 1.5-V SSTL Class I	PIN_E29
mem_dqs[5]	DDR3 Data Strobe p[5]	Differential 1.5-V SSTL Class I	PIN_G18
mem_dqs[6]	DDR3 Data Strobe p[6]	Differential 1.5-V SSTL Class I	PIN_F25
mem_dqs[7]	DDR3 Data Strobe p[7]	Differential 1.5-V SSTL Class I	PIN_J23
mem_dqs_n[0]	DDR3 Data Strobe n[0]	Differential 1.5-V SSTL Class I	PIN_C15
mem_dqs_n[1]	DDR3 Data Strobe n[1]	Differential 1.5-V SSTL Class I	PIN_J16
mem_dqs_n[2]	DDR3 Data Strobe n[2]	Differential 1.5-V SSTL Class I	PIN_K23
mem_dqs_n[3]	DDR3 Data Strobe n[3]	Differential 1.5-V SSTL Class I	PIN_B28

mem_dqs_n[4]	DDR3 Data Strobe n[4]	Differential 1.5-V SSTL Class I	PIN_D29
mem_dqs_n[5]	DDR3 Data Strobe n[5]	Differential 1.5-V SSTL Class I	PIN_F18
mem_dqs_n[6]	DDR3 Data Strobe n[6]	Differential 1.5-V SSTL Class I	PIN_E25
mem_dqs_n[7]	DDR3 Data Strobe n[7]	Differential 1.5-V SSTL Class I	PIN_H23
mem_odt[0]	DDR3 On-die Termination 0	SSTL-15 Class I	PIN_F26
mem_odt[1]	DDR3 On-die termination 1	SSTL-15 Class I	PIN_G26
mem_ras_n	DDR3 Row ADDRESS Strobe	SSTL-15 Class I	PIN_D24
mem_we_n	DDR3 Write Enable	SSTL-15 Class I	PIN_M27
mem_event_n	DDR3 Temperature Event	SSTL-15 Class I	PIN_R18
mem_reset_n	DDR3 Reset	SSTL-15 Class I	PIN_J18
mem_scl	DDR3 I2C Serial Clock	1.5V	PIN_H19
mem_sda	DDR3 I2C Serial Data Bus	1.5V	PIN_P18

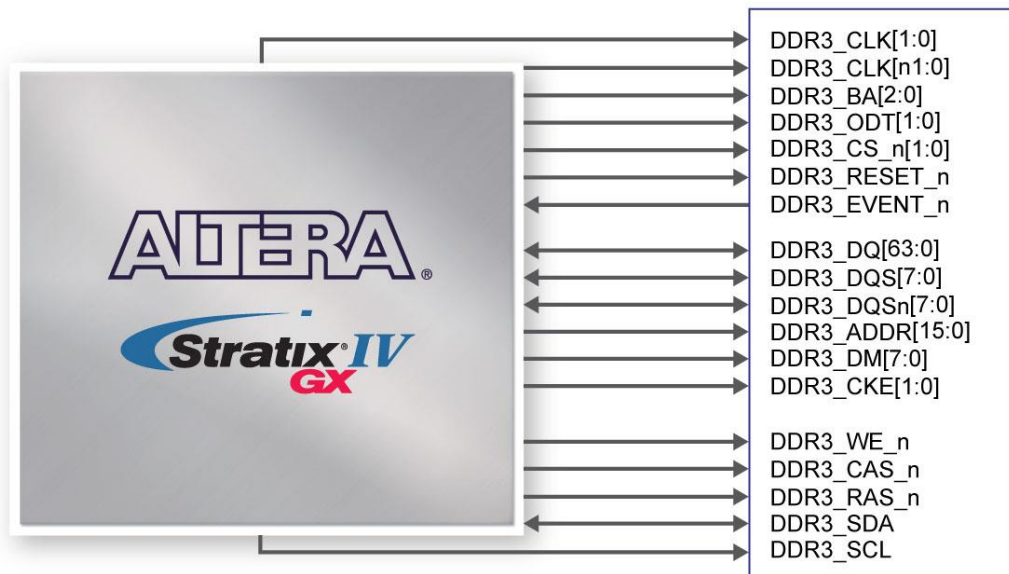

Figure 2-23 Connection between DDR3 and Stratix IV GX FPGA

2.8 Clock Circuitry

■ Stratix IV GX FPGA Clock Inputs and Outputs

The TR4 development board contains three types of clock inputs which include 26 global clock input pins, external PLL clock inputs and transceiver reference clock inputs. The clock input

sources of the Stratix IV GX FPGA originate from on-board oscillators, a 50MHz, driven through the clock buffers as well as other interfaces including HSMC, GPIO expansion headers(share pins with HSMC Port C), and SMA connectors. The overall clock distribution of the TR4 is presented in **Figure 2-24**.

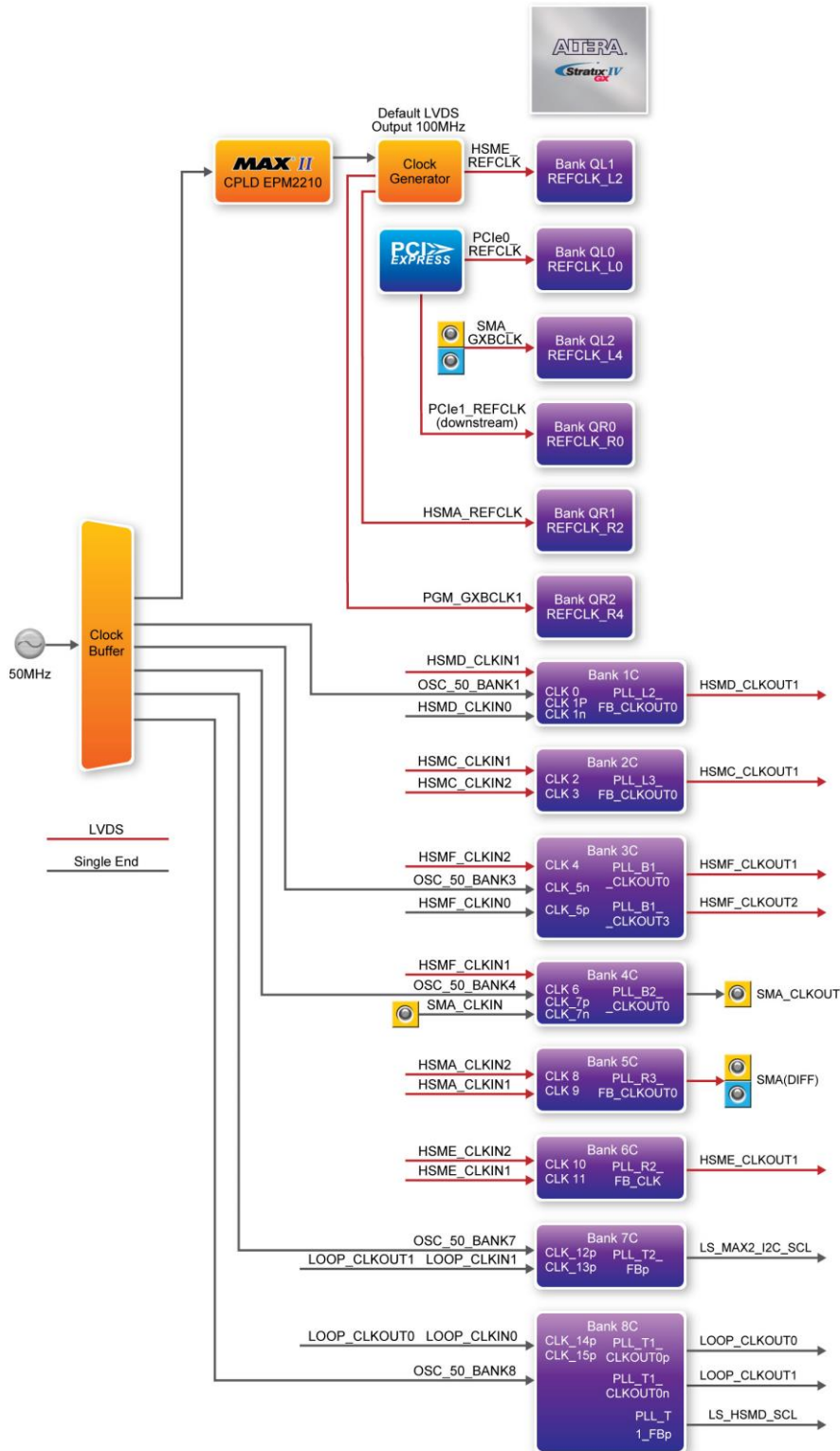

Figure 2-24 Clock Connections of the TR4

Note:

- (1) SMA_CLKOUT_p/N and some HSMC-A clock signals are connected to Bank 5C. If users use SMA_CLKOUT_p/n ,please set HSMC-A I/O standard to 2.5V.
- (2) SMA_GXBCLK_p/n input HSMC-E and PCIE0's Transceiver Bank GXBL.
- (3) PGM_GXBCLK_p1/n1input HSMC-A and PCIE1's Transceiver Bank GXBR.
- (4) HSMD_OUT0 interface through a level shift, so the maximum speed is 60Mbps.

The Stratix IV GX FPGA consists of 8 dedicated clock input pins and from those pins, 3 dedicated differential clock input listed in **Table 2–19**. In addition, there are a total of 8 PLLs available for the Stratix IV GX device.

Table 2–19 Dedicated Clock Input Pins

<i>Dedicated Clock Input Pins</i>
OSC_50_BANK1
HSMD_CLKIN0
HSMC_CLKIN_p2
HSMC_CLKIN_n2
HSMA_CLKIN_p2
HSMA_CLKIN_n2
HSME_CLKIN_p2
HSME_CLKIN_n2

The dedicated clock input pins from the clock input multiplexer allow users to use any of these clocks as a source clock to drive the Stratix IV PLL circuit through the GCLK and RCLK networks. Alternatively, PLLs through the GCLK and RCLK networks or from dedicated connections on adjacent top/bottom and left/right PLLs can also drive the PLL circuit. The clock outputs of the Stratix IV GX FPGA are derived from various interfaces, notably the HSMC and the SMA connectors.

■ Stratix IV GX FPGA Transceiver Clock Inputs

The transceiver reference clock inputs for the serial protocols supported by the Stratix IV GX FPGA transceiver channels include the PCI Express (PIPE) and the SMA connectors.

The TR4 uses three programmable low-jitter clock generators with default clock output of 100MHz and an I/O standard of LVDS that is non-configurable. The clock generators are programmed via Max II CPLD to generate the necessary clocks for the Stratix IV GX transceiver protocols and interfaces such as HSMC. The PCI Express (PIPE) transceiver reference clock is generated from the

PCIe connector.

The clock frequency for the programmable clock generators can be specified by using the TR4 control panel, TR4 system builder, or the external clock generator demo provided.

The associated pin assignments for clock buffer and SMA connectors to FPGA I/O pins are shown in [Table 2–20](#).

Table 2–20 Clock Inputs/Outputs Pin Assignments, Schematic Signal Names, and Functions

<i>Board Reference</i>	<i>Schematic Signal Name</i>	<i>Description</i>	<i>I/O Standard</i>	<i>Stratix IV GX Pin Number</i>
U49-4	OSC_50_BANK1	Dedicated 50MHz clock input for bank 1C	2.5-V	AB34
U21-4	OSC_50_BANK3	50MHz clock input for bank 3C	2.5-V	AW22
U20-4	OSC_50_BANK4	50MHz clock input for bank 4C	2.5-V	AV19
U12-4	OSC_50_BANK7	50MHz clock input for bank 7C	1.5-V	A21
U13-4	OSC_50_BANK8	50MHz clock input for bank 8C	1.5-V	B23
U11-6	HSMA_REFCLK_p	HSMC-A transceiver reference clock input	LVDS	AA2
U11-5	HSMA_REFCLK_n	HSMC-A transceiver reference clock input	LVDS	AA1
U5-6	HSME_REFCLK_p	HSMC-E transceiver reference clock input	LVDS	AA38
U5-5	HSME_REFCLK_n	HSMC-E transceiver reference clock input	LVDS	AA39
J20	SMA_CLKOUT_p	SMA differential clock output	2.5V or LVDS	AC11
J19	SMA_CLKOUT_n	SMA differential clock output	2.5V or LVDS	AC10
J16	SMA_GXBCLK_p	SMA transceiver reference clock input	LVDS	J38
J17	SMA_GXBCLK_n	SMA transceiver reference clock input	LVDS	J39
J21	SMA_CLKIN	SMA clock input	2.5V	AW19

2.9 PCI Express

The TR4 development board features two PCIe Express **downstream** interfaces (x4 lane) which are designed to interface with a PC motherboard x4 slot via PCIe cable and PCIe adapter card. Utilizing built-in transceivers on a Stratix IV GX device, it is able to provide a fully integrated PCI Express-compliant solution for multi-lane (x4) applications. With the PCI Express hard IP block incorporated in the Stratix IV GX device, it will allow users to implement simple and fast protocol, as well as saving logic resources for logic application.

The PCI Express interface supports complete PCI Express Gen1 at 2.5Gbps/lane and Gen2 at 5.0Gbps/lane protocol stack solution compliant to PCI Express base specification 2.0 that includes PHY-MAC, Data Link, and transaction layer circuitry embedded in PCI Express hard IP blocks.

To use PCIe interface, two external associated devices will be needed to establish link with PC. First, a PCIe half-height add-in host card with a PCIe x4 cable connector called PCA (PCIe Cabling Adapter Card)(See [Figure 2-25](#)) will be used to plug into the PCIe slot on a mother board. Then, a PCIe x4 cable (See [Figure 2-26](#)) will be used to connect TR4 board and PCIe add-in card as shown in [Figure 2-27](#), the longest length up to 3 meters. These two associated devices are not included in TR4 kit. To purchase the PCA card as well as the external cable, please reference Terasic website pca.terasic.com and PCIe_Cable.terasic.com.

Finally, section 6.3 and 6.4 demonstrate two examples on how to use the PCIe interface of TR4 board with a PC. [Table 2-16](#) and [Table 2-17](#) summarize the PCI Express pin assignments of the signal names relative to the Stratix IV GX FPGA.

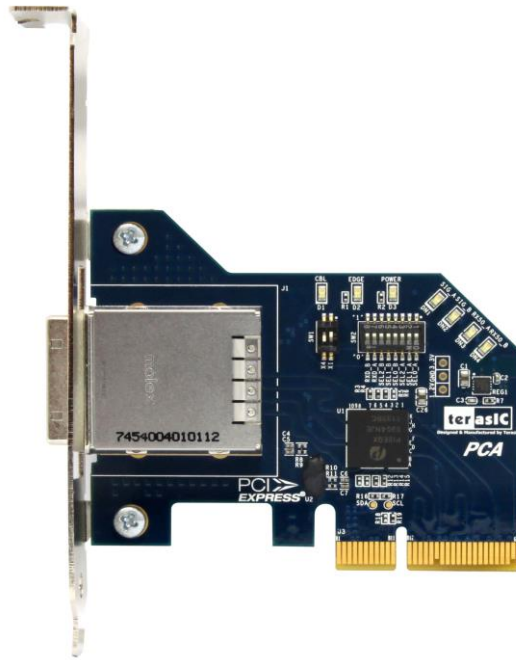

Figure 2-25 PCIe Cabling Adaptor(PCA) card



Figure 2-26 PCIe External Cable

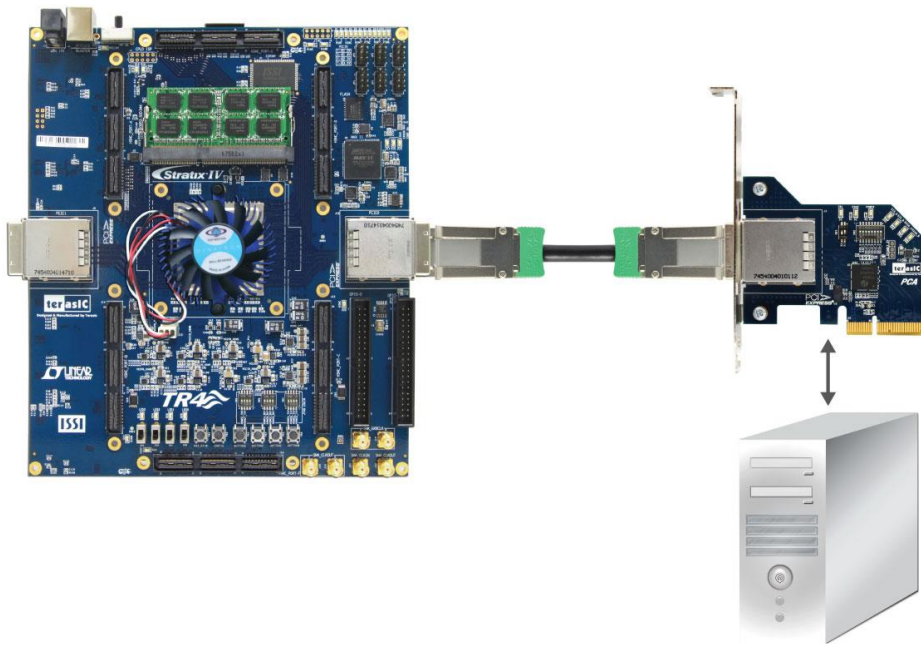

Figure 2-27 PCIe Link Setup between TR4 and PC

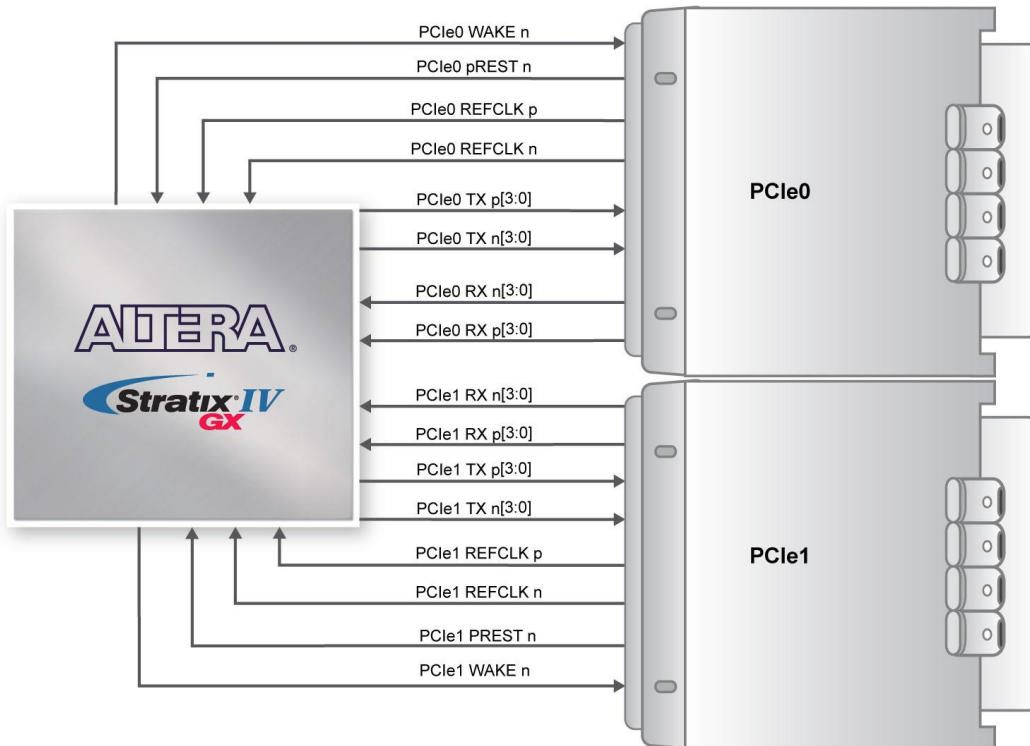

Figure 2-28 PCI Express Pin Connection

Table 2-16 PCIe0 Pin Assignments, Schematic Signal Names, and Functions

<i>PCIe0 4-Lane Downstream</i>			
<i>Name</i>	<i>Description</i>	<i>I/O Standard</i>	<i>Stratix IV GX Pin Number</i>
PCIE0_REFCLK_p	PCIe0 reference clock	HCSL	AN38
PCIE0_PREST_n	PCIe0 present	Depends on HSMC Port A I/O standard	F8
PCIE0_WAKE_n	PCIe0 wake	Depends on HSMC Port A I/O standard	AE10
PCIE0_TX_p[0]	PCIe0 data lane	1.4-V PCML	AT36
PCIE0_RX_p[0]		1.4-V PCML	AU38
PCIE0_TX_p[1]		1.4-V PCML	AP36
PCIE0_RX_p[1]		1.4-V PCML	AR38
PCIE0_TX_p[2]		1.4-V PCML	AH36
PCIE0_RX_p[2]		1.4-V PCML	AJ38
PCIE0_TX_p[3]		1.4-V PCML	AF36
PCIE0_RX_p[3]		1.4-V PCML	AG38

Table 2-17 PCIe1 Express Pin Assignments, Schematic Signal Names, and Functions

<i>PCIe1 4-Lane Downstream</i>			
<i>Name</i>	<i>Description</i>	<i>I/O Standard</i>	<i>Stratix IV GX Pin Number</i>
PCIE1_REFCLK_p	PCIe1 reference clock	HCSL	AN2
PCIE1_PREST_n	PCIe1 present	Depends on HSMC Port A I/O standard	G8
PCIE1_WAKE_n	PCIe1 wake	Depends on HSMC Port A I/O standard	AE11
PCIE1_TX_p[0]	PCIe1 data lane	1.4-V PCML	AT4
PCIE1_RX_p[0]		1.4-V PCML	AU2
PCIE1_TX_p[1]		1.4-V PCML	AP4
PCIE1_RX_p[1]		1.4-V PCML	AR2
PCIE1_TX_p[2]		1.4-V PCML	AH4
PCIE1_RX_p[2]		1.4-V PCML	AJ2
PCIE1_TX_p[3]		1.4-V PCML	AF4
PCIE1_RX_p[3]		input	

2.10 Flash Memory

The TR4 development board features a 64MB Intel CFI-compliant NOR-type flash memory device which is part of the shared FMS Bus consisting of flash memory, SSRAM, and the Max II CPLD

(EPM2210) System Controller. The single synchronous flash memory with 16-bit data bus supports 4-word, 8-word 16-word, and continuous-word burst mode provides non-volatile storage that can be used for configuration as well as software storage. The memory interface can sustain output synchronous-burst read operations at 40MHz with zero wait states. The device defaults to asynchronous page-mode read when power-up is initiated or returned from reset.

This device is also used to store configuration files for the Stratix IV GX FPGA where the MAX II CPLD (EPM2210) can access flash for FPP configuration of the FPGA using the PFL Megafunction. **Table 2-18** lists the flash pin assignments, signal names, and functions.

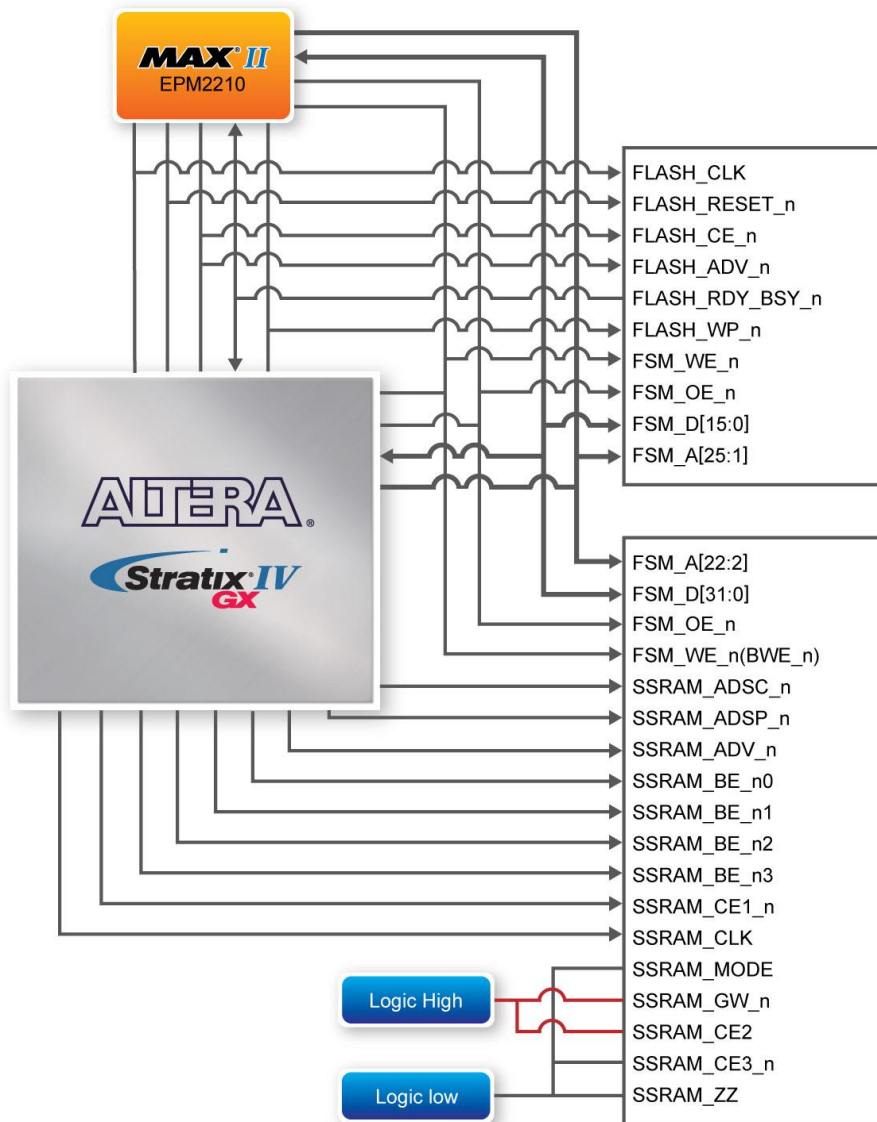

Figure 2-29 Connection between Flash, SSRAM, MAXII EPM2210 and the Stratix IV GX FPGA

Table 2-18 Flash Memory Pin Assignments, Schematic Signal Names, and Functions

<i>Schematic Signal Name</i>	<i>Description</i>	<i>I/O Standard</i>	<i>Stratix IV GX Pin Number</i>
FSM_A1	Address bus	3.0-V PCI-X	PIN_L31
FSM_A2	Address bus	3.0-V PCI-X	PIN_F34
FSM_A3	Address bus	3.0-V PCI-X	PIN_D35
FSM_A4	Address bus	3.0-V PCI-X	PIN_D34
FSM_A5	Address bus	3.0-V PCI-X	PIN_E34
FSM_A6	Address bus	3.0-V PCI-X	PIN_C35
FSM_A7	Address bus	3.0-V PCI-X	PIN_C34
FSM_A8	Address bus	3.0-V PCI-X	PIN_F33
FSM_A9	Address bus	3.0-V PCI-X	PIN_G35
FSM_A10	Address bus	3.0-V PCI-X	PIN_H35
FSM_A11	Address bus	3.0-V PCI-X	PIN_J32
FSM_A12	Address bus	3.0-V PCI-X	PIN_J33
FSM_A13	Address bus	3.0-V PCI-X	PIN_K32
FSM_A14	Address bus	3.0-V PCI-X	PIN_K31
FSM_A15	Address bus	3.0-V PCI-X	PIN_AH17
FSM_A16	Address bus	3.0-V PCI-X	PIN_AH16
FSM_A17	Address bus	3.0-V PCI-X	PIN_AE17
FSM_A18	Address bus	3.0-V PCI-X	PIN_AG16
FSM_A19	Address bus	3.0-V PCI-X	PIN_H32
FSM_A20	Address bus	3.0-V PCI-X	PIN_H34
FSM_A21	Address bus	3.0-V PCI-X	PIN_G33
FSM_A22	Address bus	3.0-V PCI-X	PIN_F35
FSM_A23	Address bus	3.0-V PCI-X	PIN_N31
FSM_A24	Address bus	3.0-V PCI-X	PIN_M31
FSM_A25	Address bus	3.0-V PCI-X	PIN_M30
FSM_D0	Data bus	3.0-V PCI-X	PIN_B32
FSM_D1	Data bus	3.0-V PCI-X	PIN_C32
FSM_D2	Data bus	3.0-V PCI-X	PIN_C31
FSM_D3	Data bus	3.0-V PCI-X	PIN_F32
FSM_D4	Data bus	3.0-V PCI-X	PIN_J30
FSM_D5	Data bus	3.0-V PCI-X	PIN_K29
FSM_D6	Data bus	3.0-V PCI-X	PIN_K30
FSM_D7	Data bus	3.0-V PCI-X	PIN_L29
FSM_D8	Data bus	3.0-V PCI-X	PIN_M29
FSM_D9	Data bus	3.0-V PCI-X	PIN_N29
FSM_D10	Data bus	3.0-V PCI-X	PIN_P29
FSM_D11	Data bus	3.0-V PCI-X	PIN_T27
FSM_D12	Data bus	3.0-V PCI-X	PIN_AM17
FSM_D13	Data bus	3.0-V PCI-X	PIN_AL17
FSM_D14	Data bus	3.0-V PCI-X	PIN_AK16

FSM_D15	Data bus	3.0-V PCI-X	PIN_AJ16
FLASH_CLK	Clock	3.0-V PCI-X	PIN_AU15
FLASH_RESET_n	Reset	3.0-V PCI-X	PIN_AV16
FLASH_CE_n	Chip Enable	3.0-V PCI-X	PIN_AP16
FSM_OE_n	Output Enable	3.0-V PCI-X	PIN_AT16
FSM_WE_n	Write Enable	3.0-V PCI-X	PIN_AL16
FLASH_ADV_n	Address Valid	3.0-V PCI-X	PIN_AT15
FLASH_RDY_BSY_n	Ready	1.5 V	PIN_A23
FLASH_WP_n	Write Protect	1.5 V	PIN_A20

2.11 SSRAM Memory

The Synchronous Static Random Access Memory (SSRAM) device featured on the TR4 development board is part of the shared Flash-SSRAM-Max II (FSM) bus, which connects to Flash memory, SSRAM, and the MAX II CPLD (E2PROM2210) System Controller. This device is a 2MB synchronously pipelined and high-speed, low-power synchronous static RAM designed to provide burstable, high-performance memory for communication and networking applications. [Table 2-19](#) lists the SSRAM pin assignments and signal names relative to the Stratix IV GX device in terms of I/O setting.

Table 2-19 SSRAM Memory Pin Assignments, Schematic Signal Names, and Functions

<i>Schematic Signal Name</i>	<i>Description</i>	<i>I/O Standard</i>	<i>Stratix IV GX Pin Number</i>
FSM_A2	Address bus A0	3.0-V PCI-X	PIN_F34
FSM_A3	Address bus A1	3.0-V PCI-X	PIN_D35
FSM_A4	Address bus A2	3.0-V PCI-X	PIN_D34
FSM_A5	Address bus A3	3.0-V PCI-X	PIN_E34
FSM_A6	Address bus A4	3.0-V PCI-X	PIN_C35
FSM_A7	Address bus A5	3.0-V PCI-X	PIN_C34
FSM_A8	Address bus A6	3.0-V PCI-X	PIN_F33
FSM_A9	Address bus A7	3.0-V PCI-X	PIN_G35
FSM_A10	Address bus A8	3.0-V PCI-X	PIN_H35
FSM_A11	Address bus A9	3.0-V PCI-X	PIN_J32
FSM_A12	Address bus A10	3.0-V PCI-X	PIN_J33
FSM_A13	Address bus A11	3.0-V PCI-X	PIN_K32
FSM_A14	Address bus A12	3.0-V PCI-X	PIN_K31
FSM_A15	Address bus A13	3.0-V PCI-X	PIN_AH17
FSM_A16	Address bus A14	3.0-V PCI-X	PIN_AH16
FSM_A17	Address bus A15	3.0-V PCI-X	PIN_AE17
FSM_A18	Address bus A16	3.0-V PCI-X	PIN_AG16
FSM_A19	Address bus A17	3.0-V PCI-X	PIN_H32

FSM_A20	Address bus A18	3.0-V PCI-X	PIN_H34
FSM_A21	Address bus A19	3.0-V PCI-X	PIN_G33
FSM_A22	Address bus A20	3.0-V PCI-X	PIN_F35
FSM_D0	Data bus	3.0-V PCI-X	PIN_B32
FSM_D1	Data bus	3.0-V PCI-X	PIN_C32
FSM_D2	Data bus	3.0-V PCI-X	PIN_C31
FSM_D3	Data bus	3.0-V PCI-X	PIN_F32
FSM_D4	Data bus	3.0-V PCI-X	PIN_J30
FSM_D5	Data bus	3.0-V PCI-X	PIN_K29
FSM_D6	Data bus	3.0-V PCI-X	PIN_K30
FSM_D7	Data bus	3.0-V PCI-X	PIN_L29
FSM_D8	Data bus	3.0-V PCI-X	PIN_M29
FSM_D9	Data bus	3.0-V PCI-X	PIN_N29
FSM_D10	Data bus	3.0-V PCI-X	PIN_P29
FSM_D11	Data bus	3.0-V PCI-X	PIN_T27
FSM_D12	Data bus	3.0-V PCI-X	PIN_AM17
FSM_D13	Data bus	3.0-V PCI-X	PIN_AL17
FSM_D14	Data bus	3.0-V PCI-X	PIN_AK16
FSM_D15	Data bus	3.0-V PCI-X	PIN_AJ16
FSM_D16	Data bus	3.0-V PCI-X	PIN_AK17
FSM_D17	Data bus	3.0-V PCI-X	PIN_T28
FSM_D18	Data bus	3.0-V PCI-X	PIN_R27
FSM_D19	Data bus	3.0-V PCI-X	PIN_R28
FSM_D20	Data bus	3.0-V PCI-X	PIN_R29
FSM_D21	Data bus	3.0-V PCI-X	PIN_N30
FSM_D22	Data bus	3.0-V PCI-X	PIN_N28
FSM_D23	Data bus	3.0-V PCI-X	PIN_M28
FSM_D24	Data bus	3.0-V PCI-X	PIN_H31
FSM_D25	Data bus	3.0-V PCI-X	PIN_G31
FSM_D26	Data bus	3.0-V PCI-X	PIN_D31
FSM_D27	Data bus	3.0-V PCI-X	PIN_E31
FSM_D28	Data bus	3.0-V PCI-X	PIN_F31
FSM_D29	Data bus	3.0-V PCI-X	PIN_E32
FSM_D30	Data bus	3.0-V PCI-X	PIN_C33
FSM_D31	Data bus	3.0-V PCI-X	PIN_D33
FSM_OE_n(OE_n)	Output Enable	3.0-V PCI-X	PIN_AT16
FSM_WE_n(BWE_n)	Byte Write Enable	3.0-V PCI-X	PIN_AL16
SSRAM_ADSC_n	Address Status Controller	3.0-V PCI-X	PIN_AP17
SSRAM_ADSP_n	Address Status Processor	3.0-V PCI-X	PIN_AR17
SSRAM_ADV_n	Synchronous Burst Address Advance	3.0-V PCI-X	PIN_AW16
SSRAM_BE_n0	Synchronous Byte Write Controls	3.0-V PCI-X	PIN_AN16
SSRAM_BE_n1	Synchronous Byte Write Controls	3.0-V PCI-X	PIN_AN17
SSRAM_BE_n2	Synchronous Byte Write Controls	3.0-V PCI-X	PIN_AR16
SSRAM_BE_n3	Synchronous Byte Write Controls	3.0-V PCI-X	PIN_AU16
SSRAM_CE1_n	Synchronous Chip Enable	3.0-V PCI-X	PIN_AF17

SSRAM_CLK	Synchronous Clock	3.0-V PCI-X	PIN_AG17
SSRAM_MODE	Burst Sequence Selection	-	-
SSRAM_GW_n	Synchronous Global Write Enable	-	-
SRAM_CE2	Synchronous Chip Enable	-	-
SSRAM_CE3_n	Synchronous Chip Enable	-	-
SSRAM_ZZ	Power Sleep Mode	-	-

2.12 Temperature Sensor and Fan

The TR4 is equipped with a temperature sensor MAX1619, which provides temperature sensing and over-temperature alerts. These functions are accomplished by connecting the temperature sensor to the internal temperature sensing diode of the Stratix IV GX device. The temperature status and alarm threshold registers of the temperature sensor can be programmed by a two-wire SMBus, which is connected to the Stratix IV GX FPGA. The 7-bit power-on-reset (POR) slave address for this sensor is ‘0011000b’.

An optional 3-pin +12V header for fan control located on J10 of the TR4 board is intended to reduce the temperature of the FPGA. When the temperature of the FPGA device is over the threshold value set by the users, the fan will turn on automatically. The pin assignments for the associated interface are listed in [Table 2-20](#).

Table 2-20 Temperature Sensor Pin Assignments, Schematic Signal Names, and Functions

<i>Schematic Signal Name</i>	<i>Description</i>	<i>I/O Standard</i>	<i>Stratix IV GX Pin Number</i>
TEMP_SMCLK	SMBus clock	2.5-V	PIN_AR14
TEMP_SMDAT	SMBus data	2.5-V	PIN_AP14
TEMP_OVERT_n	SMBus over-temperature alarm	2.5-V	PIN_AK14
TEMP_INT_n	SMBus alert (interrupt)	2.5-V	PIN_AH13
FAN_CTRL	Fan control	1.5-V	PIN_B17

2.13 Power

The TR4 board features a standalone DC input rated at 19V. The DC voltage is stepped down to various power rails used by the components on the board and installed into the HSMC connectors.

Power Switch

The slide switch (SW7) is the board power switch for the DC power input. When the slide switch is in the ON position, the board is powered on. Alternatively when the switch is in the OFF position, the board is powered off.

2.14 Security

The TR4 board features design security to protect your designs against unauthorized copying, reverse engineering, and tampering of your configuration files. For more information, please refer to Altera’s application note, “AN556: Using the Design Security Features in Altera FPGAs”

2.15 Using External Blaster

User can use external blaster to configure FPGA such us Ethernet Blaster. To use this feature, user need to install 2x5 2.54mm connector and four 0 Ohm resistor (0402 size) on J2 and R199~R201, respectively (See [Figure 2-30](#) and [Figure 2-31](#)).

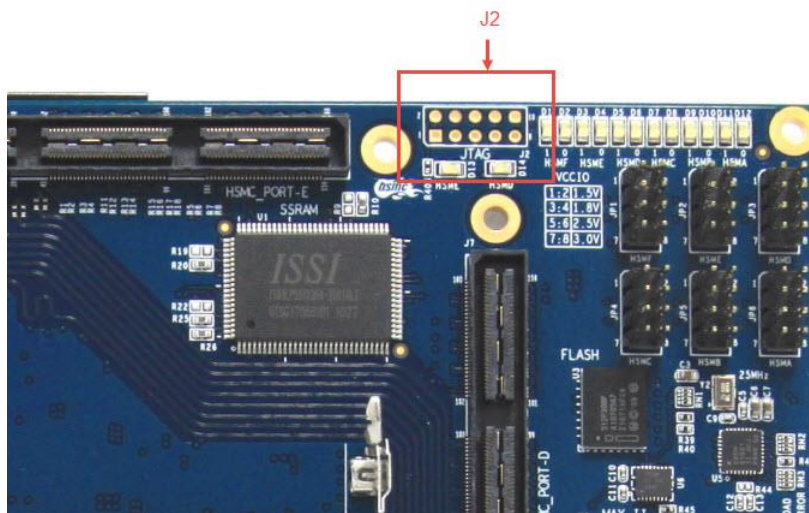

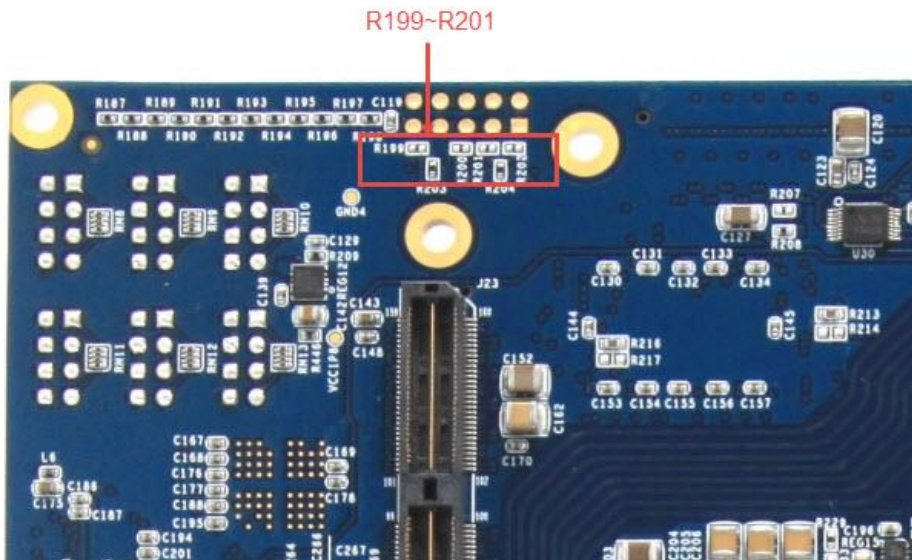

Figure 2-31 R199-R201 Position on TR4

Chapter 3

Control Panel

The TR4 board comes with a PC-based Control Panel that allows users to access various components onboard. The host computer communicates with the board via USB-Blaster port. The tool can be used to verify the functionality of components.

This chapter presents some basic functions of the Control Panel, illustrates its structure in block diagram form, and finally describes its capabilities.

3.1 Control Panel Setup

The Control Panel software utility is located in the directory “/Tools/TR4_ControlPanel” in the **TR4 System CD**. To execute the program, simply copy the whole folder to your host computer and launch the control panel by double clicking the **TR4_ControlPanel.exe**.

CAUTION. Please make sure Quartus II and USB-Blaster Driver are installed before launching TR4 Control Panel. In addition, before the TR4 control panel is launched, it is imperative that the fan is installed on the Stratix IV GX device to prevent excessively high temperatures on the FPGA.

To activate the Control Panel, perform the following steps:

- Make sure Quartus II and Nios II are installed successfully on your PC.
- Connect the supplied USB cable to the USB Blaster port and the supplied power cord to J4. Turn the power switch ON.
- Verify the connection on the USB blaster is available and not occupied or used between Quartus and TR4.

Start the executable **TR4_ControlPanel.exe** on the host computer. **Figure 3-1** will appear and the Control Panel starts to auto-detect the FPGA and download the .sof files.

After the configuration file is programmed to the TR4 board, the FPGA device information will be displayed on the window.

Note. The Control Panel will occupy the USB port; users will not be able to download any configuration file into the FPGA before you exit the Control Panel program.



Figure 3-1 Download .sof Files to the TR4 board

The Control Panel is now ready, as shown in **Figure 3-2**.



Figure 3-2 TR4 Control Panel is Ready

If the connection between TR4 board and USB-Blaster is not established, or the TR4 board is not powered on before running the **TR4_ControlPanel.exe**, the Control Panel will fail to detect the FPGA and a warning message window will pop up as shown in **Figure 3-3**.



Figure 3-3 The TR4 Control Panel Fails to Download .sof File

The concept of the TR4 Control Panel is illustrated in **Figure 3-4**. The “Control Codes” which performs the control functions is implemented in the FPGA board. It communicates with the Control Panel window, which is active on the host computer, via the USB Blaster link. The graphical user interface is used to issue commands to the control codes. It handles all requests and performs data transfer between the computer and the TR4 board.

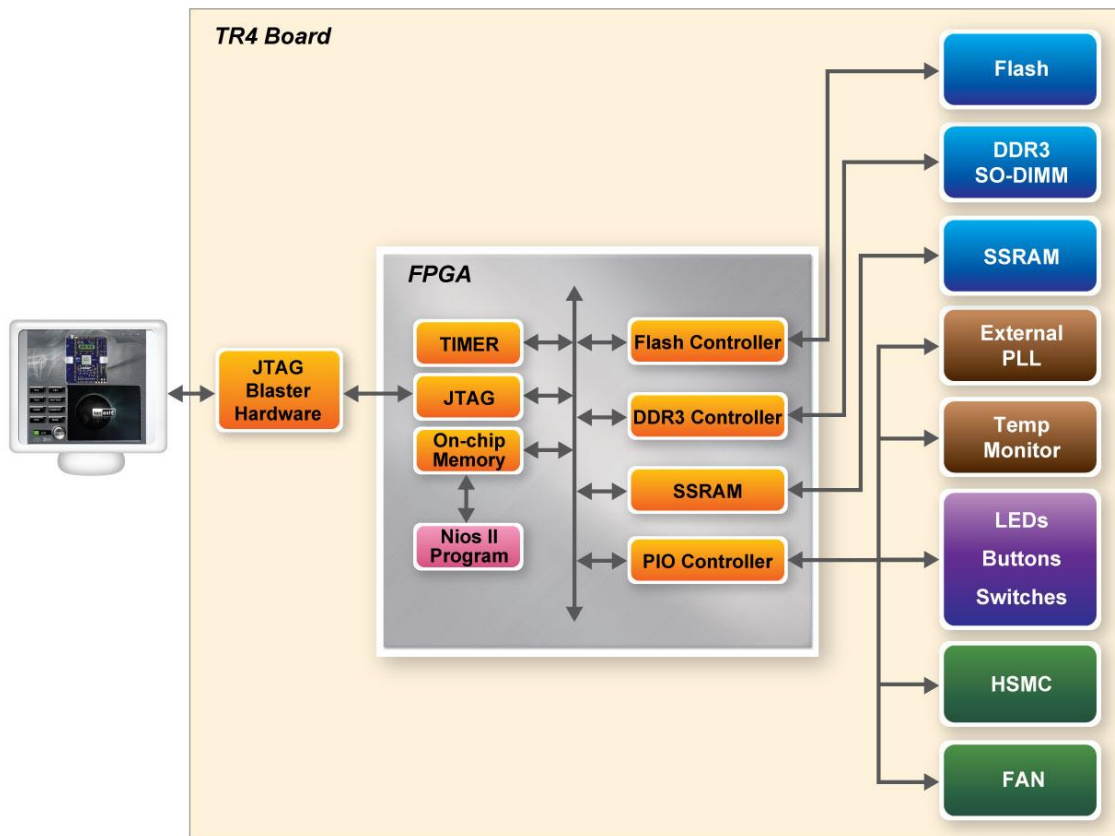

Figure 3-4 TR4 Control Panel Block Diagram

The TR4 Control Panel can be used to illuminate the LEDs, monitoring buttons/switches status, read/write from various memory types, in addition to testing various components of the TR4 board.

3.2 Controlling the LEDs

One of the functions of the Control Panel is to set up the status of the LEDs. The tab-window shown in [Figure 3-5](#) indicates where you can directly turn all the LEDs on or off individually by selecting them and clicking “Light All” or “Unlight All”.



Figure 3-5 Controlling LEDs

3.3 Switches and Push-Buttons

Choose the **Button** tab as shown in **Figure 3-6**. This function is designed to monitor status of switches and buttons from a graphical user interface in real-time. It can be used to verify the functionality of switches and buttons.



Figure 3-6 Monitoring Switches and Buttons

3.4 Memory Controller

The Control Panel can be used to write/read data to/from the DDR3 SO-DIMM/Flash/SSRAM memory on the TR4 board. We will describe how the DDR3 SO-DIMM is accessed. Click on the Memory tab to reach the tab-window shown in [Figure 3-7](#).

A 16-bit value can be written into the DDR3 SO-DIMM memory by three steps, namely specifying the address of the desired location, entering the hexadecimal data to be written, and pressing the Write button. Contents of the location can be read by pressing the **Read** button. [Figure 3-8](#) depicts the result of writing the hexadecimal value 7EFF to location 0x100, followed by reading the same location.

The Sequential Write function of the Control Panel is used to write the contents of a file to the serial configuration device, as described below:

- Specify the starting address in the **Address** box.
- Specify the number of bytes to be written in the **Length** box. If the entire file is to be loaded, a check mark can be placed in the **File Length** box instead of giving the number of bytes.
- To initiate the writing of data, click on the **Write a File to Memory** button.
- When the Control Panel responds with the standard Windows dialog box asking for the source file, specify the desired file in the usual manner.

The Sequential Read function is used to read the contents of the serial configuration device and place them into a file as follows:

- Specify the starting address in the **Address** box.
- Specify the number of bytes to be copied into a file in the **Length** box. If the entire contents of the serial configuration device are to be copied, then place a check mark in the **Entire Memory** box.
- Press Load Memory Content to a File button.
- When the Control Panel responds with the standard Windows dialog box ask for the destination file, users can specify the desired file in the usual manner.



Figure 3-7 Access DDR3 SO-DIMM Memory



Figure 3-8 Writing the Hexadecimal Value 7EFF to Location 0x100

3.5 Temperature Monitor

Choose the **Temperature** tab to reach the window shown in **Figure 3-9**. This function is designed to control temperature sensor through the Control Panel. The temperatures of Stratix IV GX and TR4 board are shown on the right-hand side of the Control Panel.

When the temperature of Stratix IV GX exceeds the maximum setting of ‘Over Temperature’ or ‘Alert’, a warning message will be shown on the Control Panel. Click “Read” button to get current settings for ‘Over temperature’ and ‘Alert’. Users can enter the maximum and minimum temperatures for ‘Over temperature’ or ‘Alert’ as required. Click the Write button to update the values entered.



Figure 3-9 Accessing the Temperature Sensor through Control Panel

3.6 PLL

The PLL function is designed to configure the external programmable PLL on the TR4. There are 3 programmable clocks for the TR4 board that generates reference clocks for the following signals HSMA_REFCLK_p/n, HSMB_REFCLK_p/n, and PGM_GXBCLK_p1/n1. The clock frequency can be adjusted to 62.5, 75, 100, 125, 150, 156.25, 187.5, 200, 250, 312.5, and 625MHz. Choose the 'PLL' tab to reach the window shown in **Figure 3-10**. To set the desire clock frequency for the associated clock signal, click on 'Set'.



Figure 3-10 Programmable External PLL Configured through Control Panel

3.7 HSMC

Choose the **HSMC** tab to reach the window shown in **Figure 3-11**. This function is designed to verify the functionality of signals found on the HSMC connectors of ports A, B, C, D, E and F using a loopback approach. Before running the loopback verification HSMC test, select the desired HSMC connector to be tested. Follow the instruction noted under *Loopback Installation* section and click on 'Verify'. Note the Control Panel HSMC loopback test does not test the transceiver signals on the HSMC interface. For HSMC transceiver loopback test, please refer to the demonstration section.

CAUTION. Turn off the TR4 board before the HSMC loopback adapter is mounted to prevent any damage to the TR4 board.



Figure 3-11 HSMC Loopback Verification Test Performed under Control Panel

3.8 Fan

Choose the **Fan** tab to reach the window shown in **Figure 3-12**. This function is designed to verify the functionality of the fan components and signals. Please make sure the fan is installed on the TR4 before running this function.



Figure 3-12 Fan Control of the TR4

3.9 Information

For more information, please click on the Information button in order to reach the window shown in **Figure 3-13.**, Users can click “Terasic Web” button and “TR4_Web” button to reach the respective websites in order to learn more about the TR4 and Terasic Technologies.



Figure 3-13 Information Tab of TR4 Control Panel

TR4 System Builder

This chapter describes how users can create a custom design project on the TR4 board by using the included TR4 software tool – TR4 System Builder.

4.1 Introduction

The TR4 System Builder is a Windows-based software utility, designed to assist users in creating a Quartus II project for the TR4 board within minutes. The generated Quartus II project files include:

- Quartus II Project File (.qpf)
- Quartus II Setting File (.qsf)
- Top-Level Design File (.v)
- External PLL Controller (.v)
- Synopsis Design Constraints file (.sdc)
- Pin Assignment Document (.htm)

The TR4 System Builder not only can generate the files above, but can also provide error-checking rules to handle situations that are prone to errors. The common mistakes that users encounter are the following:

- Board damaged due to wrong pin/bank voltage assignments
- Board malfunction caused by wrong device connections or missing pin counts for connections
- Poor performance drop due to improper pin assignments

4.2 General Design Flow

This section will introduce the general design flow to build a project for the TR4 board via the TR4 System Builder. The general design flow is illustrated in the **Figure 4-1**.

Users should launch TR4 System Builder and create a new project according to their design requirements. When users complete the settings, the TR4 System Builder will generate two major files which include a top-level design file (.v) and the Quartus II settings file (.qsf).

The top-level design file contains a top-level Verilog wrapper for users to add their own design/logic. The Quartus II settings file contains information such as FPGA device type, top-level pin assignments, and I/O standards for each user-defined I/O pin.

Finally, Quartus II programmer must be used to download SOF file to TR4 board using JTAG interface.

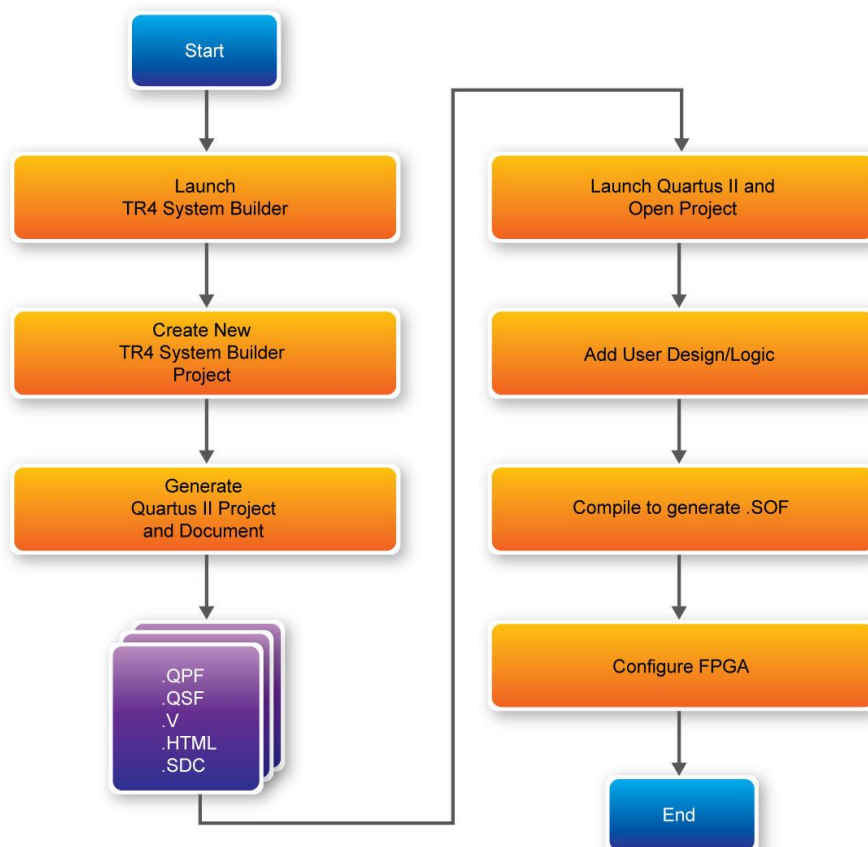

Figure 4-1 General Design Flow

4.3 Using TR4 System Builder

This section provides the detail procedures on how the TR4 System Builder is used.

Install and launch the TR4 System Builder

The TR4 System Builder is located in the directory: "**Tools\TR4_SystemBuilder**" in the TR4 System CD. Users can copy the whole folder to a host computer without installing the utility. Before using the TR4 System Builder, execute the **TR4_SystemBuilder.exe** on the host computer as appears in **Figure 4-2**.

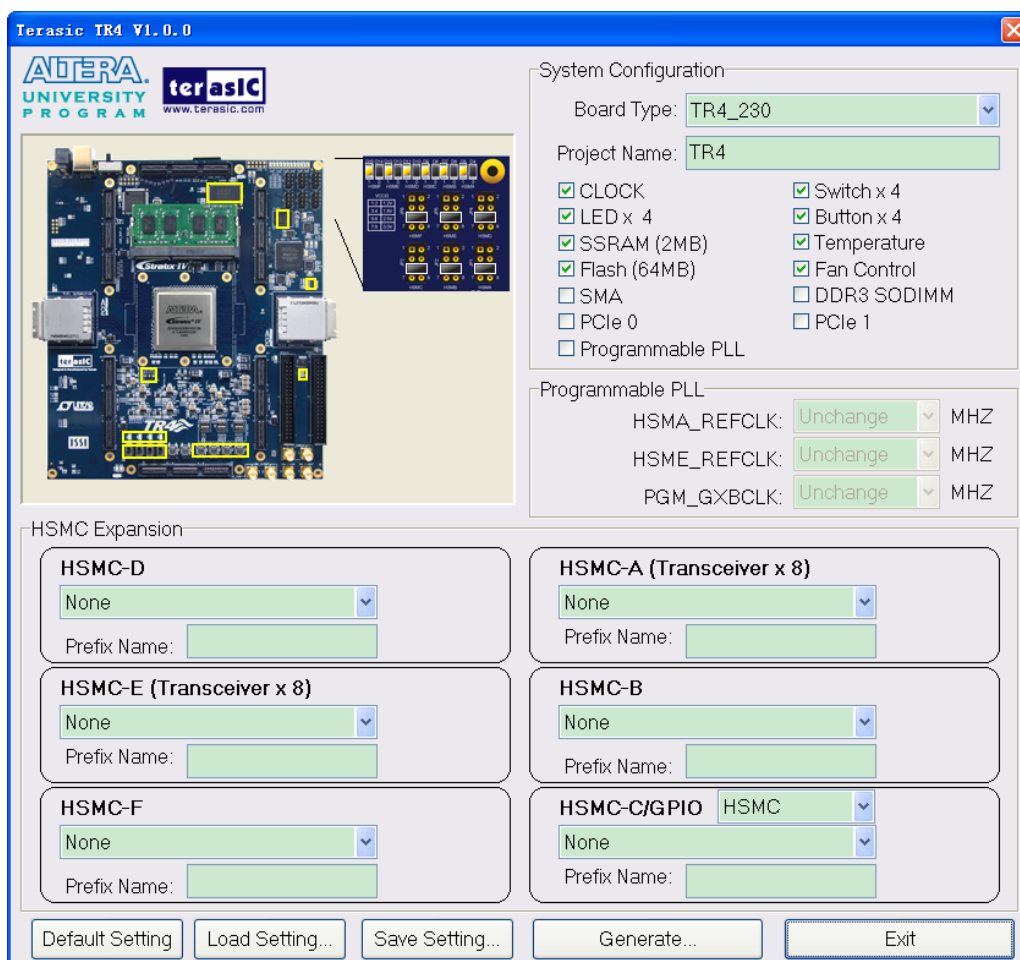

Figure 4-2 TR4 System Builder Window

Select Board Type and Input Project Name

Select the target board type and input project name as show in **Figure 4-3**.

- Board Type: Select the appropriate FPGA device according to the TR4 board which includes the EP4SGX230 and EP4SGX530 devices.
- Project Name: Specify the project name as it is automatically assigned to the name of the top-level design entity.

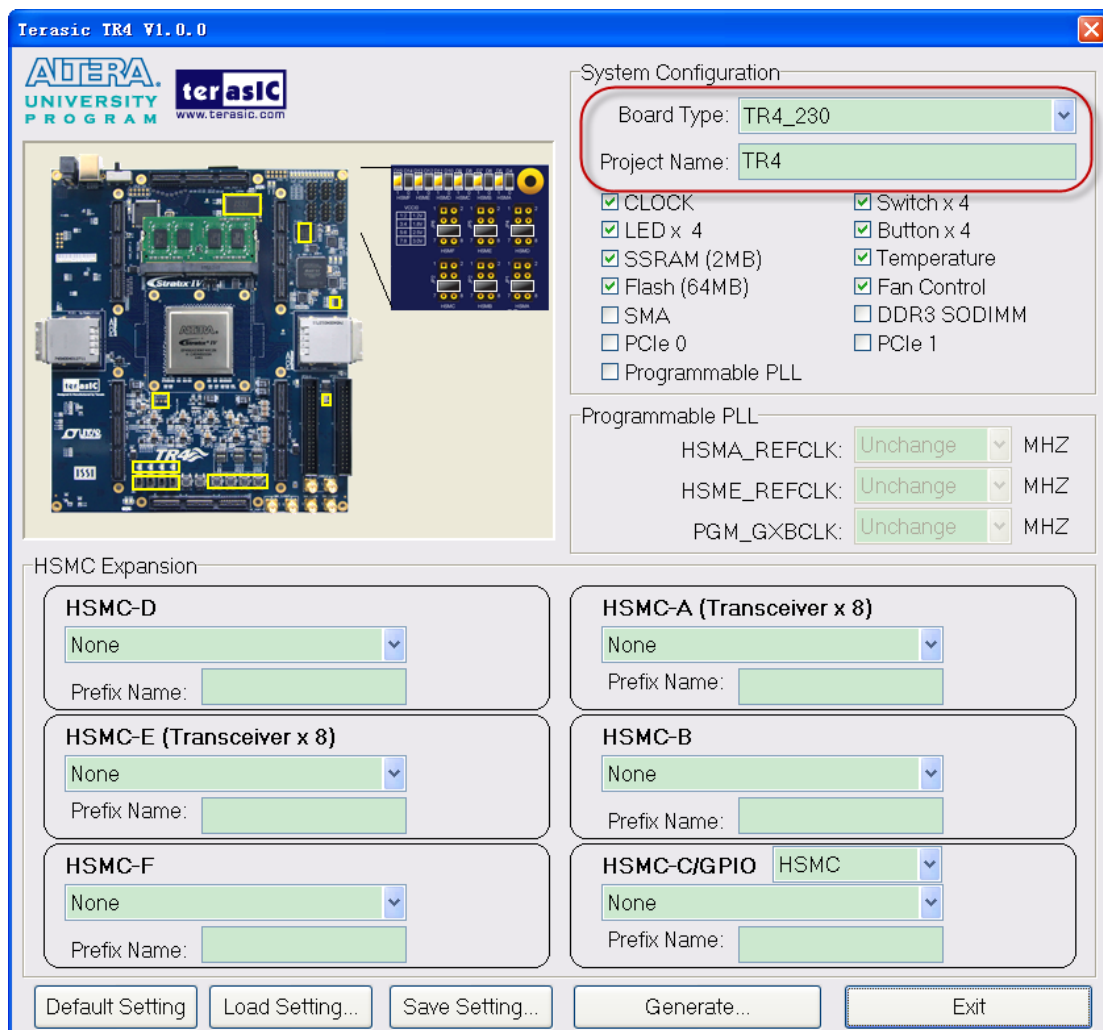

Figure 4-3 TR4 Board Type and Project Name

System Configuration

Under System Configuration, users are given the flexibility of enabling their choice of components

on the TR4 as shown in **Figure 4-4**. Each component of the TR4 is listed where users can enable or disable a component according to their design by simply marking a check or removing the check in the field provided. If the component is enabled, the TR4 System Builder will automatically generate the associated pin assignments including the pin name, pin location, pin direction, and I/O standards.

Note. The pin assignments for some components for e.g. DDR3 require associated controller codes in the Quartus II project otherwise Quartus II will result in compilation errors. Therefore, do not select them if they are not necessary in your design.

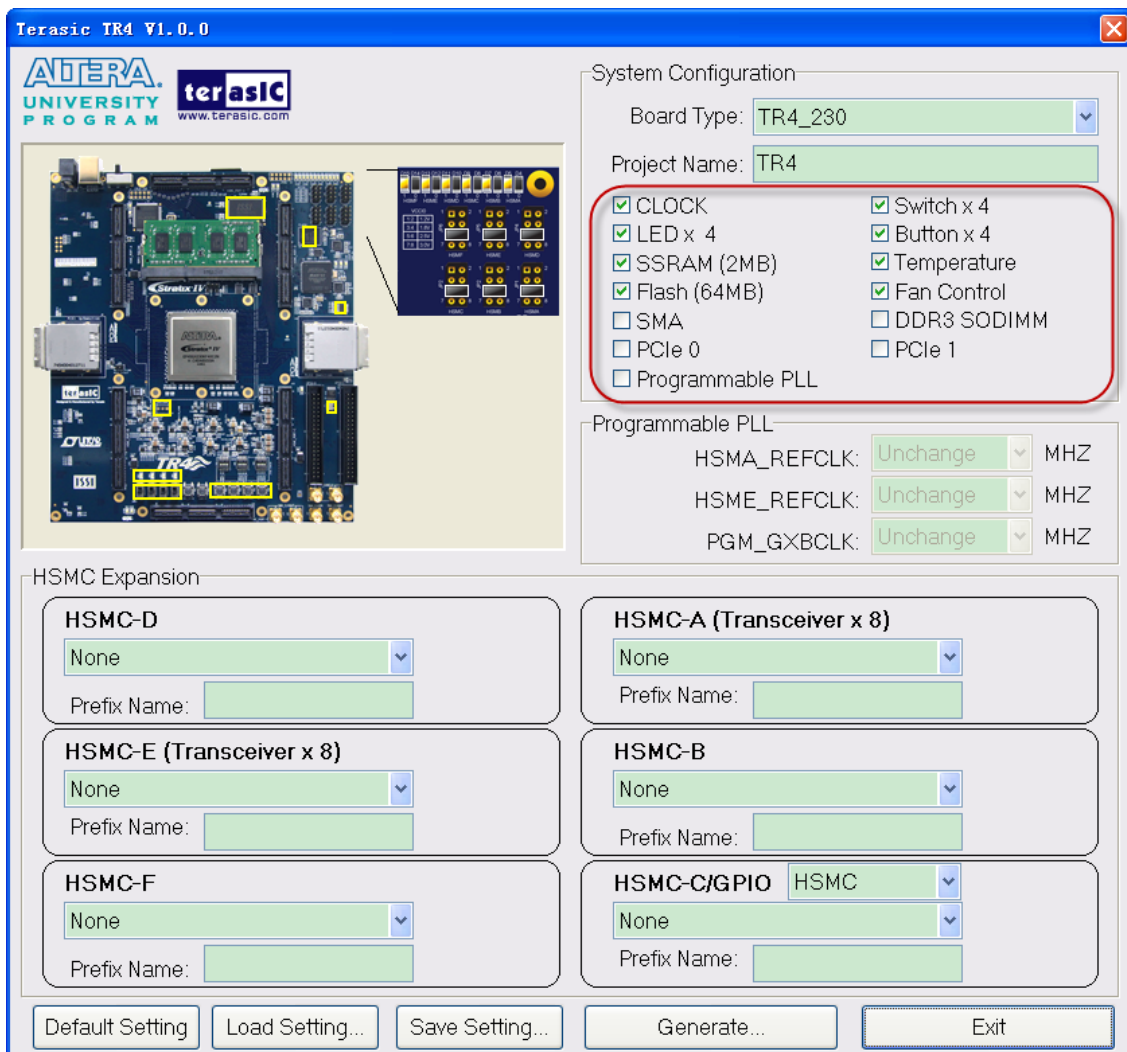

Figure 4-4 System Configuration Group

Programmable PLL

There are three external programmable PLLs on-board that provide reference clocks for the following signals HSMA_REFCLK, HSME_REFCLK and PGM_GXBCLK. To use these PLLs, users can select the desired frequency on the Programmable PLL group, as shown in **Figure 4-5**.

As the Quartus II project is created, System Builder automatically generates the associated PLL configuration code according to users' desired frequency in Verilog which facilitates users' implementation as no additional control code is required to configure the PLLs.

Note. If users need to dynamically change the frequency, they will need to modify the generated control code themselves.

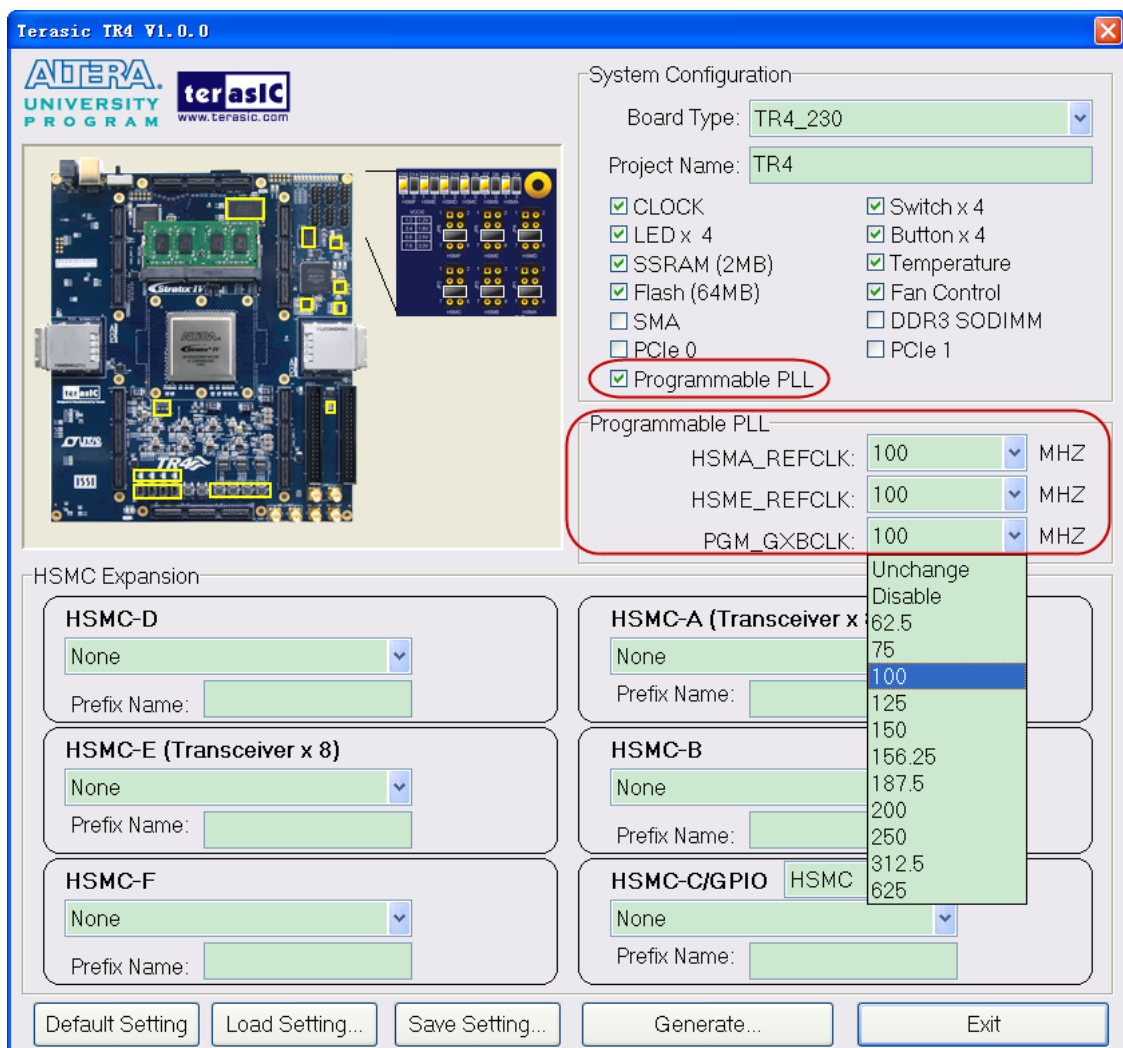

Figure 4-5 External Programmable PLL

HSMC Expansion

Users can connect HSMC-interfaced daughter cards onto the HSMC ports located on the TR4 board shown in **Figure 4-6**. Select the daughter card you wish to add to your design under the appropriate HSMC connector where the daughter card is connected to. The System Builder will automatically generate the associated pin assignment including pin name, pin location, pin direction, and IO standard.

If a customized daughter board is used, users can select “HSMC Default” followed by changing the pin name, pin direction, and IO standard according to the specification of the customized daughter board. If transceiver pins are not required on the daughter board, please remember to remove it, otherwise Quartus II will report errors.

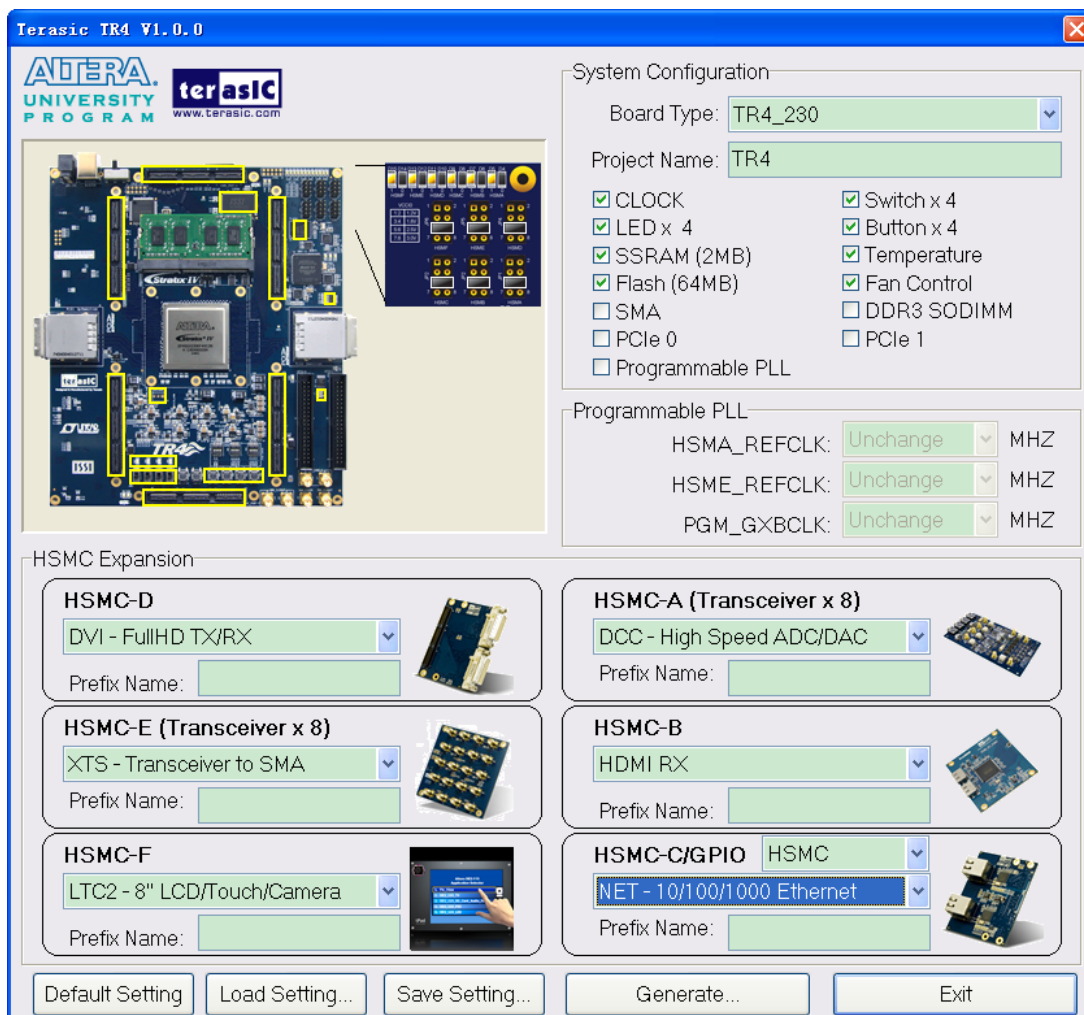

Figure 4-6 HSMC Expansion Group

The “Prefix Name” is an optional feature that denotes the pin name of the daughter card assigned in your design. Users may leave this field empty.

Note. If the same HSMC daughter card is selected in both HSMC-A and HSMC-B expansion, a prefix name is required to avoid pin name duplication as shown in **Figure 4-7**, otherwise System Builder will prompt an error message.

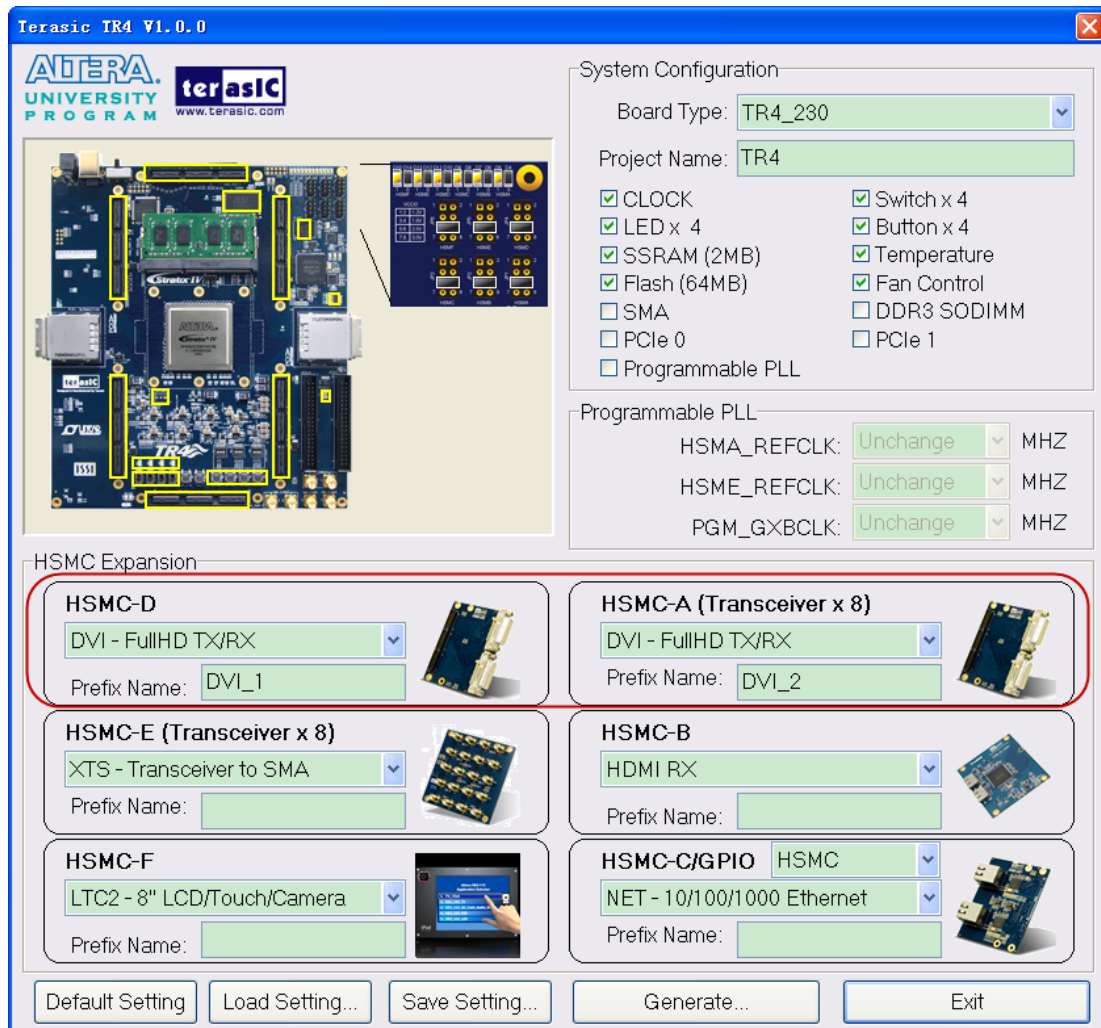

Figure 4-7 Specify Prefix Name for HSMC Expansion Board

Additionally, users can choose the “HSMC-C/GPIO” as either “HSMC” or “GPIO”, since the GPIO ports share pins with HSMC Port C as shown in **Figure 4-8**.

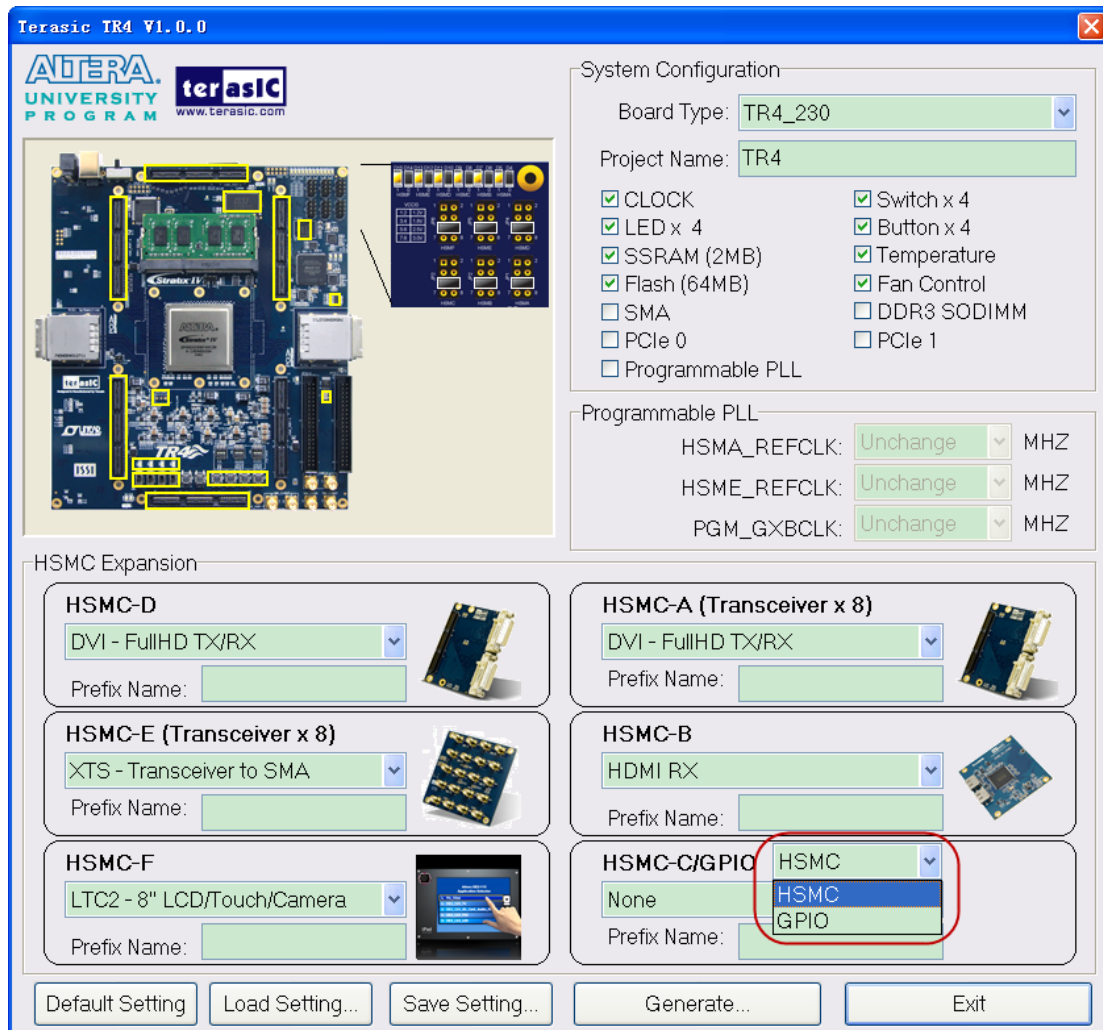

Figure 4-8 HSMC-C/GPIO share pins option

After users select the “GPIO” option, a “GPIO Edit” button will appear. If this is clicked, a “GPIO Expansion” window will pop up for users to select a compatible Terasic daughter card. Once a daughter card selected, the JP4 header diagram in the upper left hand corner of the window, which configures HSMC Port C and GPIO I/O standards will adjust automatically to recommend a suitable I/O standard for the selected daughter card as shown in **Figure 4-9**.

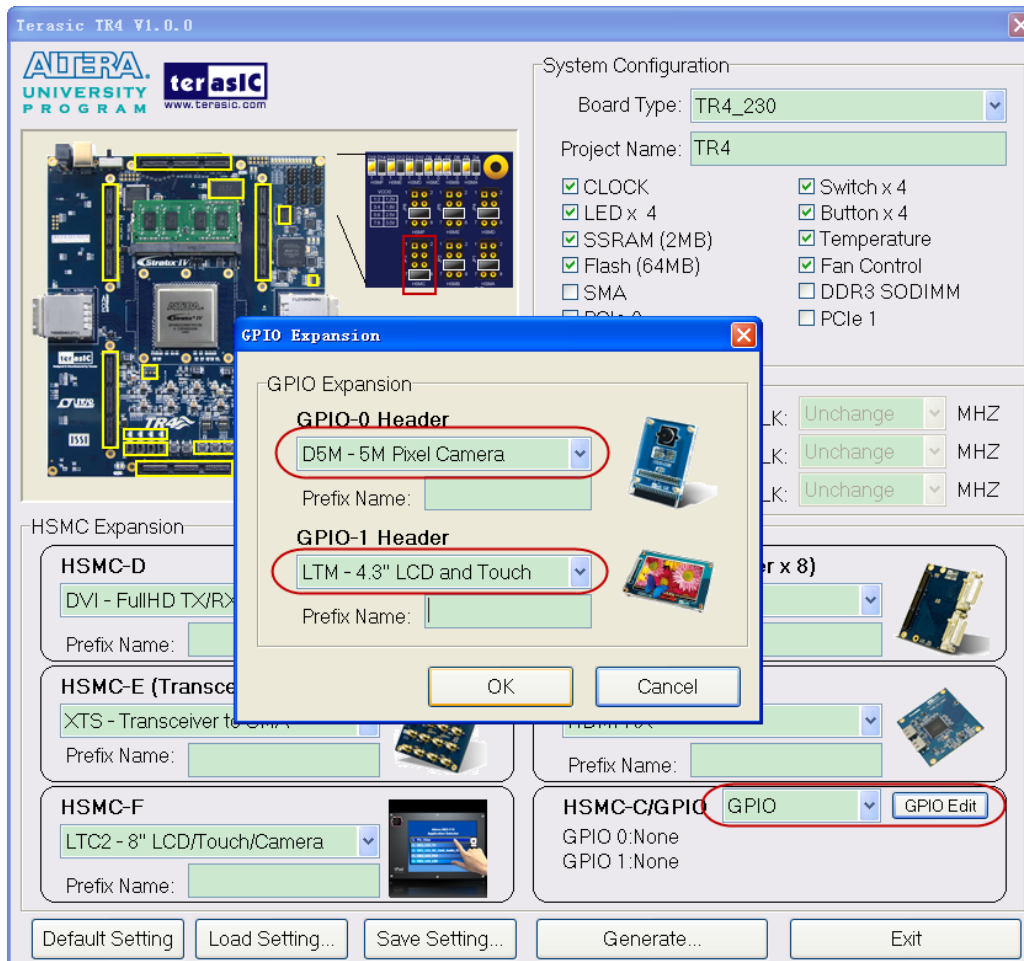

Figure 4-9 GPIO option and I/O standard recommend

Project Setting Management

The TR4 System Builder also provides functions to restore a default setting, loading a setting, and saving users' board configuration file shown in **Figure 4-10**. Users can save the current board configuration information into a .cfg file and load it to the TR4 System Builder.

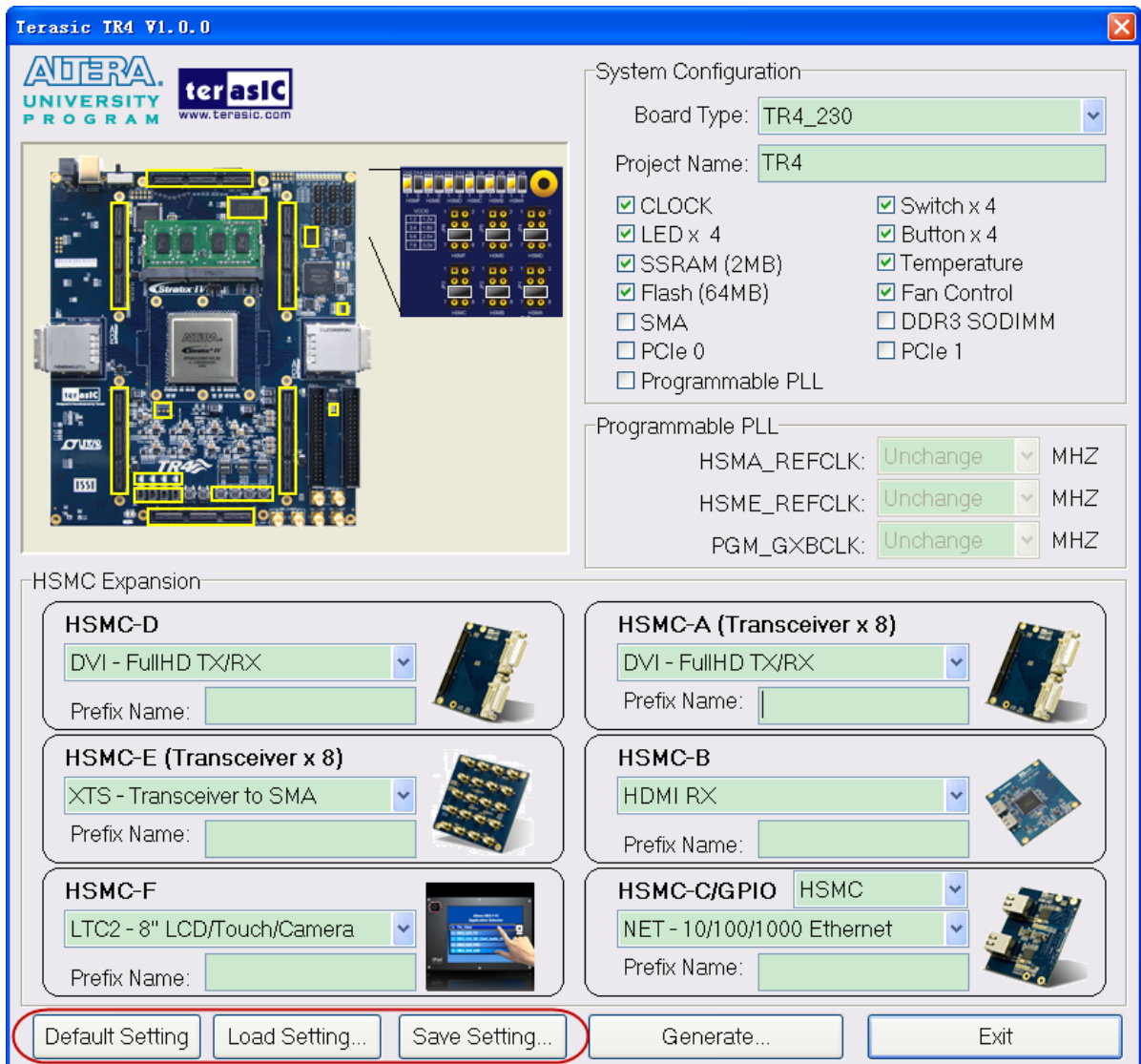

Figure 4-10 Project Settings

Project Generation

When users press the **Generate** button, the TR4 System Builder will generate the corresponding Quartus II files and documents as listed in the **Table 4-1** in the directory specified by the user.

Table 4-1 Files Generated by TR4 System Builder

No.	Filename	Description
1	<Project name>.v	Top level Verilog file for Quartus II
2	EXT_PLL_CTRL.v	External PLL configuration controller IP
3	<Project name>.qpf	Quartus II Project File

4	<Project name>.qsf	Quartus II Setting File
5	<Project name>.sdc	Synopsis Design Constraints file for Quartus II
6	<Project name>.htm	Pin Assignment Document

Users can use Quartus II software to add custom logic into the project and compile the project to generate the SRAM Object File (.sof).

In addition, External Programmable PLL Configuration Controller IP will be instantiated in the Quartus II top-level file as listed below:

```

ext_pll_ctrl  u_ext_pll_ctrl
(
    // system input
    .osc_50(OSC_50_BANK1),
    .rstn(rstn),
    // device 1
    .clk1_set_wr(clk1_set_wr),
    .clk1_set_rd(),
    // device 2
    .clk2_set_wr(clk2_set_wr),
    .clk2_set_rd(),
    // device 3
    .clk3_set_wr(clk3_set_wr),
    .clk3_set_rd(),
    // setting trigger
    .conf_wr(conf_wr),           // 1T 50MHz
    .conf_rd(),                 // 1T 50MHz
    // status
    .conf_ready(),
    // 2-wire interface
    .max_sclk(MAX2_I2C_SCL),
    .max_sdat(MAX2_I2C_SDA)
);

```

If dynamic PLL configuration is required, users need to modify the code according to users' desired PLL behavior.

Chapter 5

Examples of Advanced Demonstration

This chapter introduces several advanced designs that demonstrate Stratix IV GX features using the TR4 board. The provided designs include the major features on board such as the HSMC connectors, PCIe, and DDR3. For each demonstration the Stratix IV GX FPGA configuration file is provided, as well as full source code in Verilog HDL. All of the associated files can be found in the *demonstrations\tr4_<Stratix device>* folder from the **TR4 System CD**. For each of demonstrations described in the following sections, we give the name of the project directory for its files, which are sub-directories of the *demonstrations\tr4_<Stratix_device>* folder.

5.1 Breathing LEDs

This demonstration shows how to use the FPGA to control the luminance of the LEDs by means of dividing frequency. By dividing the frequency from 50 MHz to 1 Hz, you can see LED flash once per second.

Design Tools

- Quartus II 11.1

Demonstration Source Code

- Project directory: *Breathing_LEDs*
- Bit stream used: *Breathing_LEDs.sof*

Demonstration Batch File

- Demo Batch File Folder: Breathing_LEDs\ Demo_batch
- The demo batch file includes following files:
- Batch File: Breathing_LEDs.bat
- FPGA Configuration File: Breathing_LEDs.sof

Demonstration Setup

- Make sure Quartus II and Nios II are installed on your PC.
- Connect the USB Blaster cable to the TR4 board and host PC. Install the USB Blaster driver if necessary.
- Power on the TR4 board.
- Execute the demo batch file “Breathing_LEDs.bat” under the batch file folder, TR4_Breathing_LEDs\Demo_batch.
- Press **BUTTON0** of the TR4 board to reset.
- The LEDs will pulse according to the set frequency.

5.2 External Clock Generator

The External Clock Generator provides designers with 3 programmable clock generators via Texas Instruments chips (CDCM61001RHBT x 2, CDCM61004RHBT) with the ability to specify the clock frequency individually, as well as addressing the input reference clock for the Stratix IV GX transceivers. The programmable clock is controlled by a control bus connected to the MAX II EPM2210 device. This can reduce the Stratix IV GX I/O usage while enabling greater functionality on the FPGA device. The MAX II EPM2210 device is capable of storing the last entered clock settings at which in the event the board restarts, the last known clock settings are fully restored. In this demonstration, we illustrate how to utilize the clock generators IP to define the clock output using the serial bus. The programmable clock outputs generate clock signals HSMA_REFCLK_p/n (CDCM61001/01), PGM_GXBCLK_p1/n1 (CDCM61004), and HSME_REFCLK_p/n (CDCM61001/02) with adjustable output clock frequencies of 62.5, 75, 100, 125, 150, 156.25, 187.5, 200, 250, 312.5, and 625MHz. The I/O standard for the clock frequencies is set to LVDS which is not configurable.

An overall block diagram of the external clock generator is shown below in **Figure 5-1**.

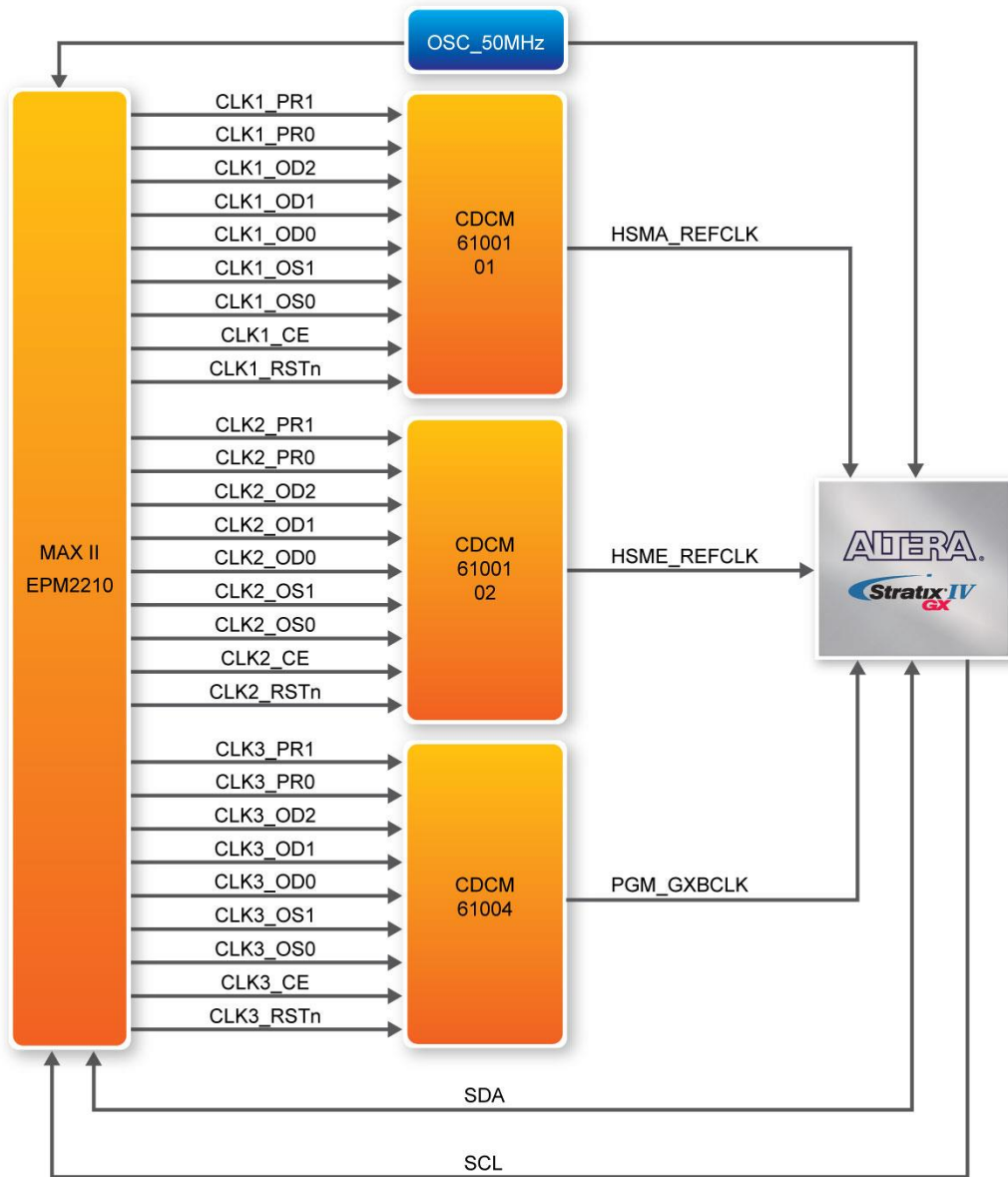

Figure 5-1 External Clock Generator Block Diagram

The EXT_PLL_CTRL IP Port Description

This section describes the operation for the EXT_PLL_CTRL instruction hardware port. **Figure 5-2** shows the EXT_PLL_CTRL instruction block diagram connected to the MAX II EPM2210 device. The EXT_PLL_CTRL controller module is defined by a host device, the Stratix IV GX FPGA and a

slave device, the MAX II EPM2210. Through the I2C bus interface, the EXT_PLL_CTRL controller is able to control the Max II device by specifying the desire clock outputs set by the user. By changing the IP parameters of the Terasic EXT_PLL_CTRL IP, the external clock output frequency can be adjusted accordingly.

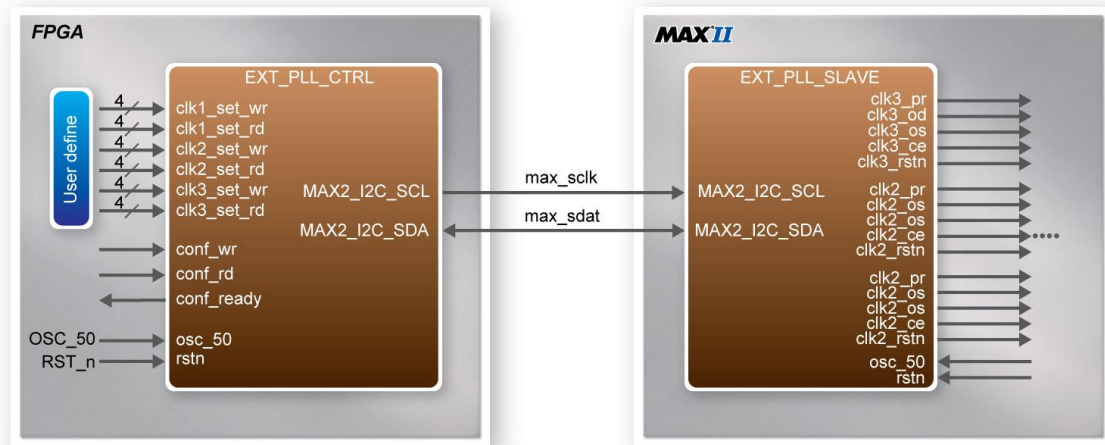

Figure 5-2 EXT_PLL_CTRL Instruction Hardware Ports

Table 5-1 lists the EXT_PLL_CTRL instruction ports

Table 5-1 EXT_PLL_CTRL Instruction Ports

Port Name	Direction	Description
osc_50	input	System Clock (50MHz)
rstn	input	Synchronous Reset (0: Module Reset, 1: Normal)
clk1_set_wr clk2_set_wr clk3_set_wr	input	Setting Output Frequency Value
clk1_set_rd clk2_set_rd clk3_set_rd	output	Read Back Output Frequency Value
conf_wr	Input	Start to Transfer Serial Data (positive edge)
conf_rd	Input	Start to Read Serial Data (positive edge)
conf_ready	Output	Serial Data Transmission is Complete (0: Transmission in Progress, 1: Transmission Complete)
max_sclk	Output	Serial Clock to MAX II
max_sdat	Inout	Serial Data to/from MAX II

The EXT_PLL_CTRL IP Parameter Setting

Users can refer to the following **Table 5-2** to set the external clock generator for the output frequency.

Table 5-2 EXT_PLL_CTRL Instruction Ports

<i>clk1_set_wr/ clk2_set_wr/ clk3_set_wr</i>	<i>Output Frequency (MHz)</i>	<i>Description</i>	
4'b0001	x	Clock Generator Disable	
4'b0010	62.5	Setting External Clock Generator	
4'b0011	75		
4'b0100	100		
4'b0101	125		
4'b0110	150		
4'b0111	156.23		
4'b1000	187		
4'b1001	200		
4'b1010	250		
4'b1011	312.5		
4'b1100	625		
Others	x		Setting Unchanged

The EXT_PLL_CTRL IP Timing Diagram

In this reference design the output frequency is set to 62.5, 75 and 100 MHz with the following timing diagrams illustrated below.

When the `ext_pll_ctrl` IP receives the 'conf_wr' signal, the user needs to define (`clk1_set_wr`, `clk2_set_wr` and `clk3_set_wr`) to set the External Clock Generator. When the `ext_pll_ctrl` IP receives the 'conf_rd' signal, it will read the value back to `clk1_set_rd`, `clk2_set_rd`, and `clk3_set_rd`.

Write Timing Waveform:

As **BUTTON0** (the trigger source defined by Terasic) is pressed, the 'conf_wr' signal is on the rising edge, serial data is transferred immediately with the 'conf_ready' signal in the transmission period starting at falling edge level as shown in **Figure 5-3**. As the transfer is completed, the 'conf_ready' signal returns back to original state at high-level.

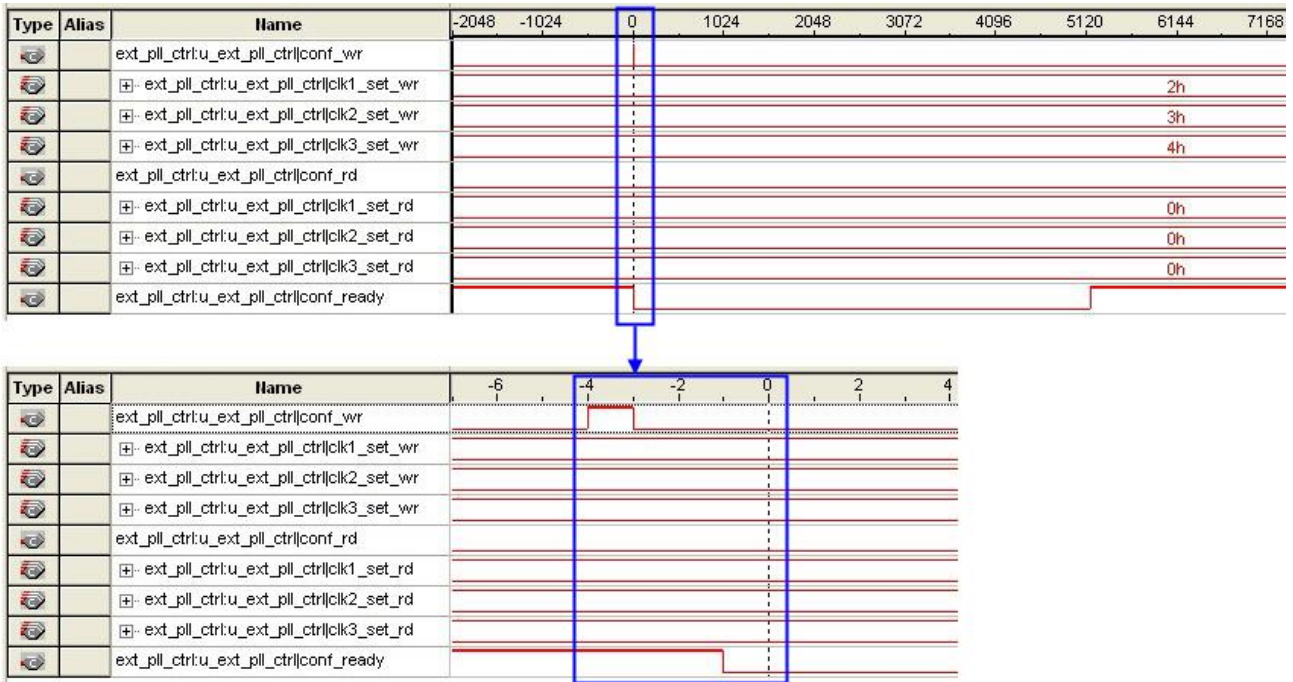

Figure 5-3 Write Timing Waveform

Read Timing Waveform:

As **BUTTON1** (the trigger source defined by Terasic) is pressed the 'conf_rd' signal is on the rising edge, the user settings are read back immediately once the 'conf_ready' signal is on the falling edge as shown in **Figure 5-4**. As the transfer is complete, the 'conf_ready' returns back to original state at high-level.

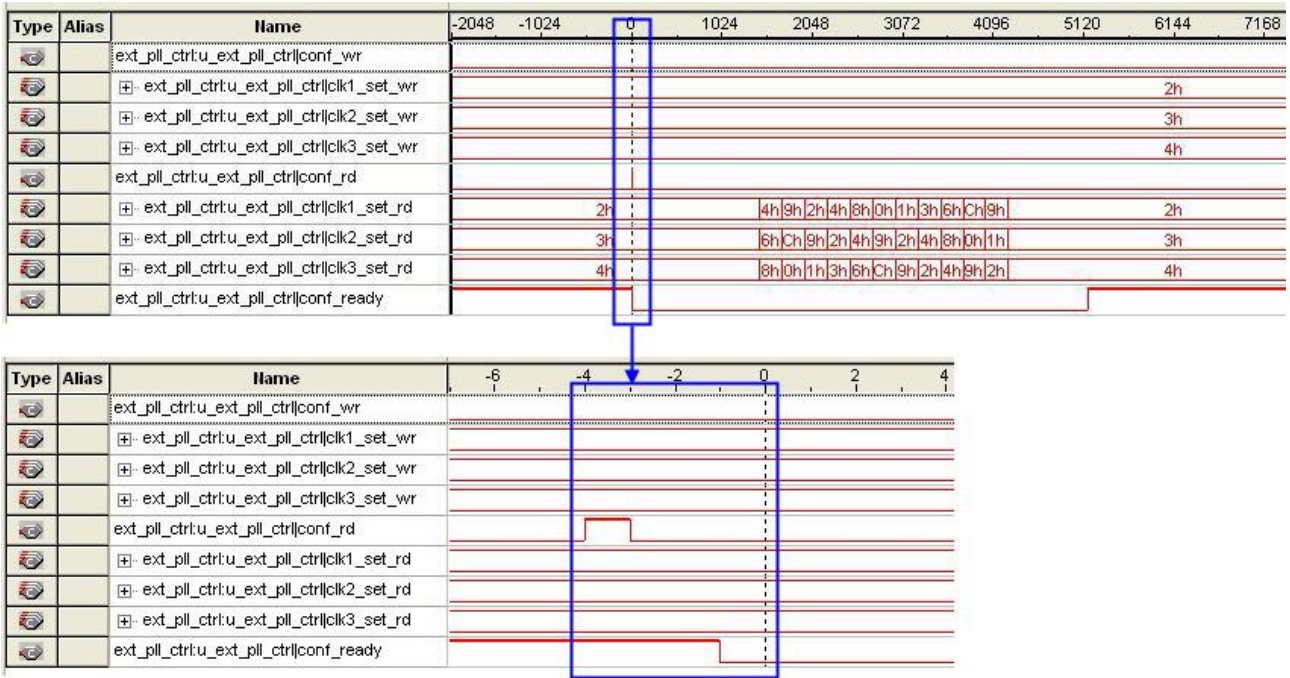

Figure 5-4 Read Timing Waveform

Design Tools

- Quartus II 11.1

Demonstration Source Code

- Project directory: *TR4_EXT_PLL*
- Bit stream used: *TR4_EXT_PLL.sof*
- Demonstration Batch File
- Demo Batch File Folder: *TR4_EXT_PLL\demo_batch*

The demo batch file folders include the following files:

- Batch File: *TR4_EXT_PLL.bat*
- FPGA Configuration File: *TR4_EXT_PLL.sof*

Demonstration Setup

- Make sure Quartus II is installed on your PC.
- Connect the USB Blaster cable to the TR4 board and host PC. Install the USB Blaster driver if necessary.
- Power on the TR4 board.
- Execute the demo batch file “*TR4_EXT_PLL.bat*” under the batch file folder, *TR4_EXT_PLL\demo_batch*
- Press **BUTTON0** to configure the external PLL chips via MAX CPLD.

5.3 High Speed Mezzanine Card (HSMC)

The HSMC loopback demonstration reference design observes the traffic flow with an HSMC loopback adapter which provides a quick way to implement your own design utilizing the transceiver signals situated on the HSMC interface. This design also helps you verify the transceiver signals functionality for ports A and E of the HSMC interface. A total of 8 transceiver pairs on the HSMC Port A and port E each are tested.

HSMC Port A Loopback Test:

Demonstration Source Code

Quartus Project directory: *TR4_HSMA_LOOPBACK_TEST*

FPGA Bit Stream: *TR4_HSMA_LOOPBACK_TEST.sof*

Demonstration Setup

- Check that Quartus II and Nios II are installed on your PC.
- Insert the HSMC loopback adapter onto the HSMC Port A.
- Connect the USB Blaster cable to the TR4 board and host PC. Install the USB Blaster driver if necessary.
- Power on the TR4 board.
- Program the TR4 using the *TR4_HSMA_LOOPBACK_TEST.sof* through Quartus II programmer.

- Press **BUTTON0** of the TR4 board to initiate the verification process.
- LED [3:0] will flash indicating the loopback test passed.

HSMC Port E Loopback Test:

Demonstration Source Code

Quartus Project directory: *TR4_HSME_LOOPBACK_TEST*

FPGA Bit Stream: *TR4_HSME_LOOPBACK_TEST.sof*

Demonstration Setup

- Check that Quartus II and Nios II are installed on your PC.
- Insert the HSMC loopback daughter card onto the HSMC Port E as shown in Figure 5-5.
- Connect the USB Blaster cable to the TR4 board and host PC. Install the USB Blaster driver if necessary.
- Power on the TR4 board.
- Program the TR4 using the *TR4_HSME_LOOPBACK_TEST.sof* through Quartus II programmer.
- Press **BUTTON0** on the TR4 board to initiate the verification process
- LED [3:0] will flash once to indicate the loopback test passed.

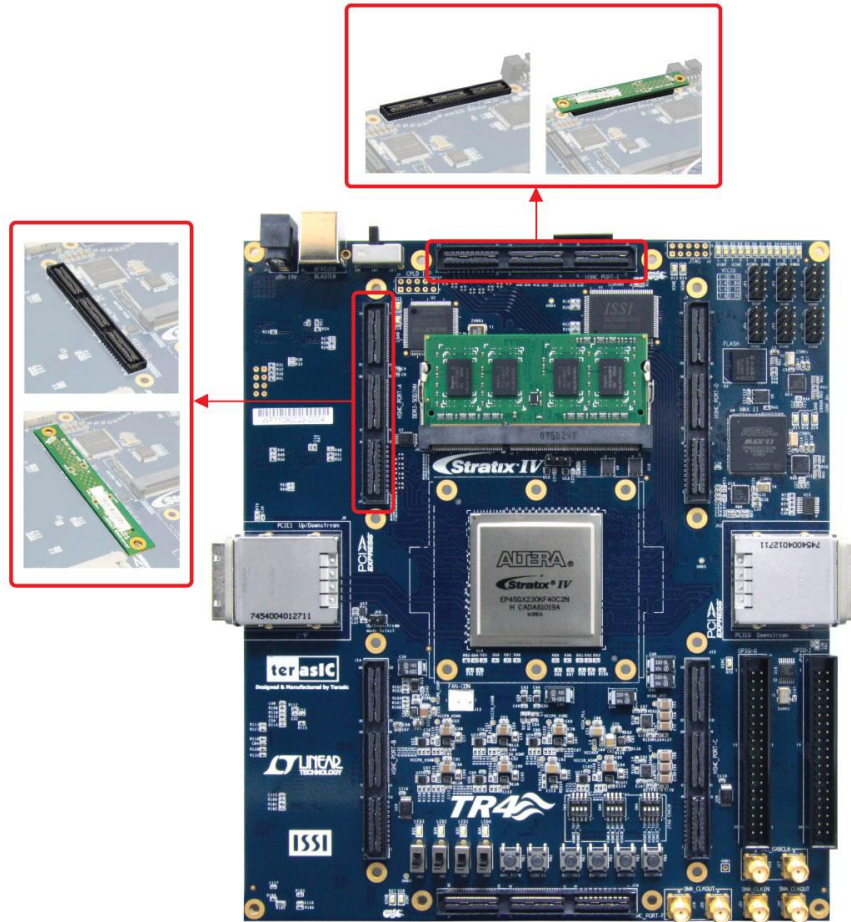

Figure 5-5 HSMC Loopback Design Setup

5.4 DDR3 SDRAM (1GB)

Many applications use a high performance RAM, such as a DDR3 SDRAM to provide temporary storage. In this demonstration hardware and software designs are provided to illustrate how the DDR3 SDRAM SODIMM on the TR4 can be accessed. We describe how the Altera’s “DDR3 SDRAM Controller with UniPHY” IP is used to create a DDR3-SDRAM controller, and how the Nios II processor is used to read and write the SDRAM for hardware verification. The DDR3 SDRAM controller handles the complex aspects of using DDR3-SDRAM by initializing the memory devices, managing SDRAM banks, and keeping the devices refreshed at appropriate intervals. The required DDR3-SDRAM SODIMM module should be 1 GB DDR3-1066.

System Block Diagram

Figure 5-6 shows the system block diagram of this demonstration. The system requires a 50 MHz clock provided from the board. The DDR3 controller is configured as a 1GB DDR3-1066 controller. The DDR3 IP generates one 533.0 MHz clock as memory clock and one quarter-rate system clock 133.125 MHz for controllers, e.g. Nios II processor, accessing the SDRAM. In Qsys, Nios II and On-Chip Memory are designed running with the 133.125 MHz clock, and the other controllers are designed running with 50 MHz clock which is the external clock. The Nios II program itself is running in the on-chip memory.

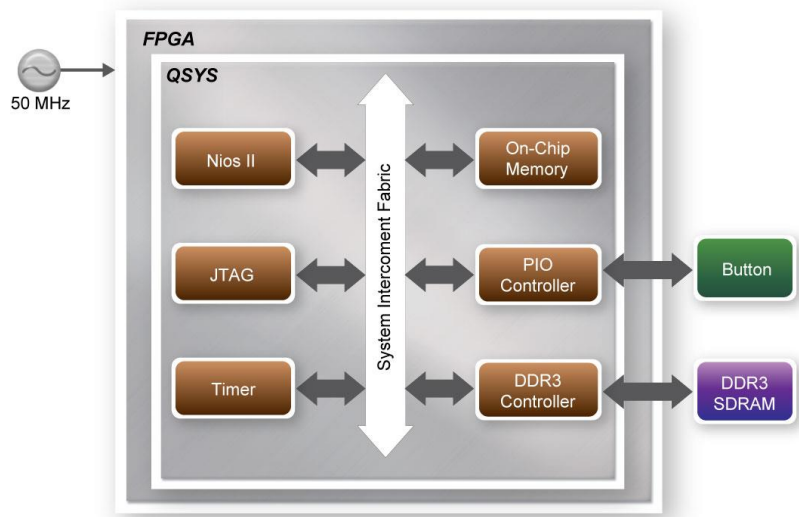

Figure 5-6 Block diagram of the DDR3 1G demonstration

The system flow is controlled by a Nios II program. First, the Nios II program writes test patterns into the DDR3, filling it up to maximum capacity. Then, it calls a Nios II system function, `alt_dache_flush_all`, to make sure all data has been written. Finally, it reads data from DDR3 for data verification. The program will show progress in JTAG-Terminal when writing/reading data to/from the DDR3. When the verification process is completed, the result is displayed in the JTAG-Terminal.

Altera DDR3 SDRAM Controller with UniPHY

To use the Altera DDR3 controller, users need to perform three major steps: 1). Create correct pin assignments for the DDR3. 2). Set up correct parameters in DDR3 controller dialog. 3). Execute TCL files, generated by DDR3 IP, under your Quartus II project.

The following section describes some of the important issues in support of the DDR3 controller

configuration. On the “PHY_Setting” tab, in order to achieve 533.0 MHz clock frequency, a reference clock frequency of 50 MHz should be used. If a different DDR3 SODIMM is used, the memory parameters should be modified according to the datasheet of the DDR3 SODIMM.

Design Tools

- Quartus II 11.1
- Nios II IDE 11.1

Demonstration Source Code

- Project directory: TR4_DDR3_UniPHY_1G_QSYS
- Bit stream used: TR4_DDR3_UniPHY_1G_QSYS.sof
- Nios II Workspace: TR4_DDR3_UniPHY_1G_QSYS\Software

Demonstration Batch File

Demo Batch File Folder: *TR4_DDR3_UniPHY_1G_QSYS\demo_batch*

The demo batch file includes following files:

- Batch File: TR4_DDR3_UniPHY_1G_QSYS.bat, TR4_DDR3_UniPHY_1G_QSYS_bashrc
- FPGA Configuration File: TR4_DDR3_UniPHY_1G_QSYS.sof
- Nios II Program: TR4_DDR3_UniPHY_1G_QSYS.elf

Demonstration Setup

- Make sure Quartus II and Nios II are installed on your PC.
- Make sure DDR3-SDRAM SODIMM (1G) is inserted into your TR4 board, as shown in [Figure 5-7](#).
- Connect the USB Blaster cable to the TR4 board and host PC. Install the USB Blaster driver if necessary.
- Power on the TR4 board.
- Execute the demo batch file “*TR4_DDR3_UniPHY_1G_QSYS.bat*” under the batch file folder,

TR4_DDR3_UniPHY_1G_QSYS\demo_batch.

- After Nios II program is downloaded and executed successfully, a prompt message will be displayed in nios2-terminal.
- Press **BUTTON3~BUTTON0** of the TR4 board to start the DDR3 verification process. Press **BUTTON0** to continue the test and **Ctrl+C** to terminate the test
- The program will display the progress and result, as shown in **Figure 5-8**

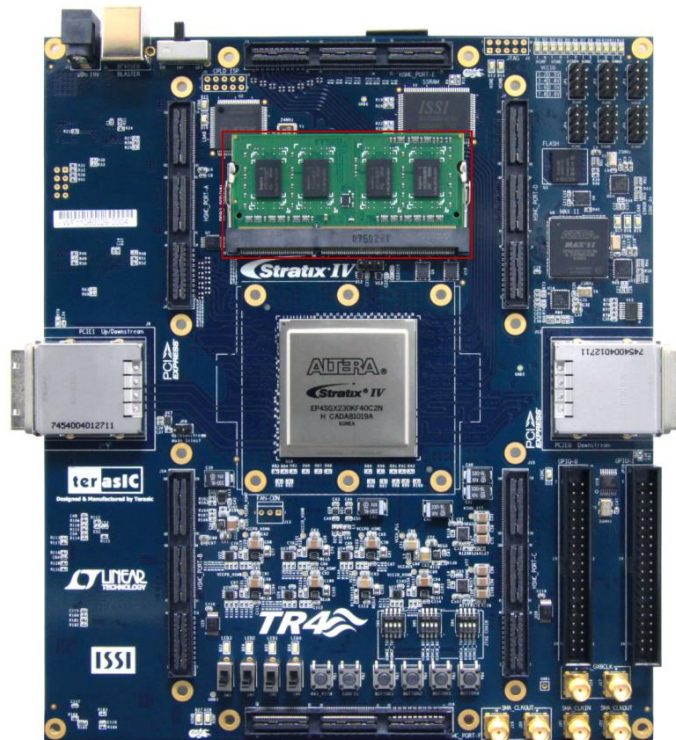

Figure 5-7 Insert the DDR3-SDRAM SODIMM for the DDR3 1G Demonstration

```
c:\ Nios II EDS 11.0sp1 [gcc3]
Initializing CPU cache <if present>
OK
Downloaded 67KB in 1.1s <60.9KB/s>
Verified OK
Starting processor at address 0x410201B4
nios2-terminal: connected to hardware target using JTAG UART on cable
nios2-terminal: "USB-Blaster [USB-01]", device 1, instance 0
nios2-terminal: <Use the IDE stop button or Ctrl-C to terminate>

==== TR4 DDR3 Test Program ====
DDR3 Clock: 533 MHZ
DDR3 Size: 1024 MBytes

=====
Press any BUTTON to start test [BUTTON0 for continued test]
====> DDR3 Testing, Iteration: 1
write...
10% 20% 30% 40% 50% 60% 70% 80% 90% 100%
read/verify...
10% 20% 30% 40% 50% 60% 70% 80% 90% 100%
DDR3 test pass, size=1073741824 bytes, 133.070 sec

=====
Press any BUTTON to start test [BUTTON0 for continued test]
```

Figure 5-8 Display Progress and Result for the DDR3 1G Demonstration

5.5 DDR3 SDRAM (4GB)

This demonstration presents user a basic utilization of DDR3-SDRAM (4G) on TR4. It describes how the Altera’s “DDR3 SDRAM Controller with UniPHY” IP is used to create a DDR3-SDRAM controller, and modify the IP-generated example top to test the entire space of DDR3-SDRAM. This demonstration is a pure RTL project. The required DDR3-SDRAM SODIMM module should be exactly 4 GB of DDR3-1066.

Function Block Diagram

Figure 5-9 shows the function block diagram of this demonstration. The DDR3 controller is configured as a 4GB DDR3-1066 controller. The DDR3 IP generates one 533.0 MHz clock as memory clock and one half-rate system clock, 266.5 MHz, for the controller.

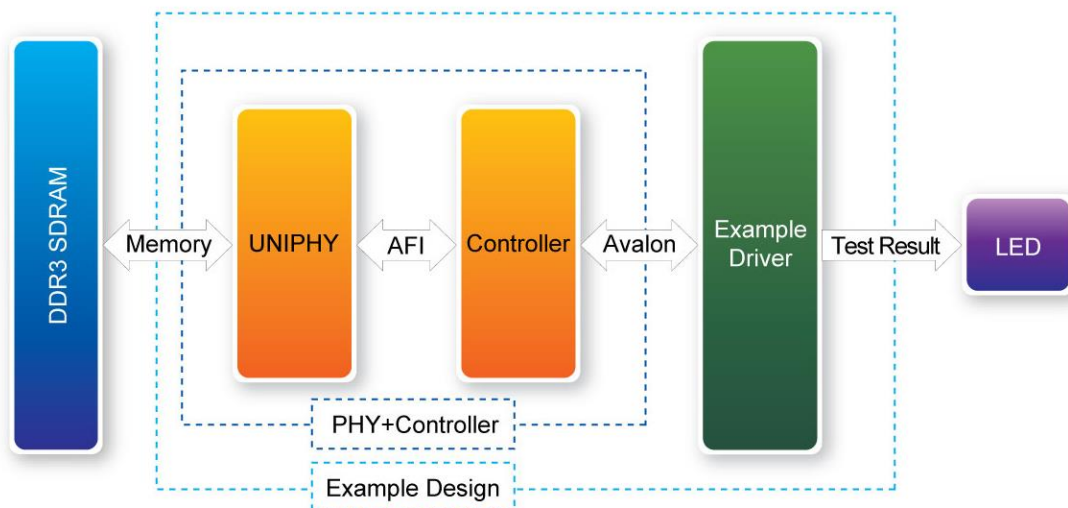

Figure 5-9 Block Diagram of the DDR3 4G Demonstration

The project is based on the example top code which is generated by the DDR3 IP, and can be used to test the whole module after modifying the code. In the project, example driver will read out the data for a comparison after writing every 1KB pseudo-random data. The read compare module will buffer the write data, and then compare it with the data read back. If the right result is achieved, the address will be accumulated and the test will check the whole memory span of 4GB after finishing $4 \times 1024 \times 1024$ loops.

Altera DDR3 SDRAM Controller with UniPHY

To use Altera DDR3 controller, users need to perform three major steps: 1). Create correct pin assignment for DDR3. 2). Setup correct parameters in DDR3 controller dialog. 3). Execute TCL files, generated by DDR3 IP, under your Quartus project.

The following section describes some of the important issues in support of the DDR3 controller configuration. On the “PHY_Setting” tab, in order to achieve 533.0 MHz clock frequency, a reference clock frequency of 50 MHz should be used.

Design Tools

- Quartus II 11.1

Demonstration Source Code

- Project directory: TR4_DDR3_UniPHY_4G_RTL
- Bit stream used: TR4_DDR3_UniPHY_4G_RTL.sof

Demonstration Batch File

Demo Batch File Folder: *TR4_DDR3_UniPHY_4G_RTL\demo_batch*

The demo batch file includes following files:

- Batch File: TR4_DDR3_UniPHY_4G_RTL.bat
- FPGA Configure File: TR4_DDR3_UniPHY_4G_RTL.sof

Demonstration Setup

- Make sure Quartus II is installed on your PC.
- Make sure DDR3-SDRAM SODIMM (4 GB) is installed on your TR4 board, as shown in [Figure 5-10](#).
- Connect the USB Blaster cable to the TR4 board and host PC. Install the USB Blaster driver if necessary.
- Power on the TR4 board.
- Execute the demo batch file “*TR4_DDR3_UniPHY_4G_RTL.bat*” under the batch file folder, *TR4_DDR3_UniPHY_4G_RTL\demo_batch*.
- Press **BUTTON0** of the TR4 board to start the verification process. When **BUTTON0** is pressed, all the LEDs go out. At the instant of releasing **BUTTON0**, **LED3** should turn on (local_init_done). After approximately 15 seconds, if **LED0** and **LED1** turn on, the test has passed.
- If **LED2** turns on at any time during the process, the test has failed. [Table 5-3](#) lists the function for different LEDs.
- Press **BUTTON0** to reset the process for a repeat test.

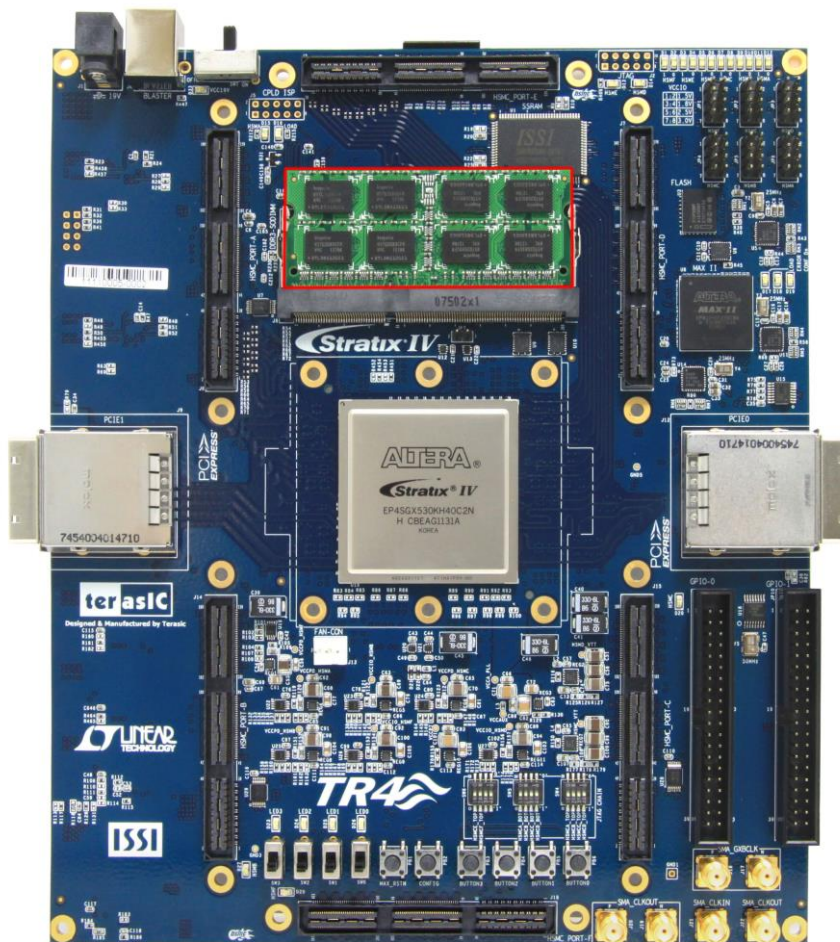

Figure 5-10 Insert DDR3-SDRAM SODIMM for the DDR3 4G Demonstration

Table 5-3 LED Indicators

NAME	Description
LED0	test complete
LED1	test pass
LED2	test fail
LED3	local_init_done & local_cal_success

Additional Information

Getting Help

Here is the contact information where you can get help if you encounter problems:

- Terasic Technologies
9F, No.176, Sec.2, Gongdao 5th Rd, East Dist, Hsinchu City, Taiwan 300-70
Email : support@terasic.com
Web : www.terasic.com

Revision History

Date	Version	Changes
2011.12.29	First publication	
2012.03.01	V1.1	Update PCA Card
2012.03.08	V1.2	Update PCIe driver
2013.09.10	V1.3	Update HSMC pin table
2014.2.10	V1.4	Swap pin assignment of hsmc table. HSMC_RX_n0 , HSMC_RX_p0
2014.3.18	V1.5	Modify table2-7 and HSMC feature
2015.01.07	V1.6	Update FPGA embedded ram size
2015.06.03	V1.7	Modify table 7-6 to change i/o standard to CMOS I/O and 2.5V
2016.08.11	V1.8	Add Section 2.15 Using External Blaster
2017.03.30	V1.9	Remove Altera Logo
2018.06.06	V2.0	Modify DDR3 SO-DIMM socket maximum capacity from 4G to 8G