



RF Power LDMOS Transistors

High Ruggedness N-Channel Enhancement-Mode Lateral MOSFETs

These RF power devices are designed for commercial applications operating at frequencies from 1200 to 1400 MHz such as commercial L-Band radars. The devices are suitable for use in pulse applications.

Typical Pulse Performance: In 1200–1400 MHz reference circuit, $V_{DD} = 50$ Vdc, $I_{DQ(A+B)} = 100$ mA, $P_{in} = 25$ W

Frequency (MHz)	Signal Type	P_{out} (W)	G_{ps} (dB)	η_D (%)
1200	Pulse (300 μ sec, 12% Duty Cycle)	950 Peak	15.8	46.5
1300		1120 Peak	16.5	47.5
1400		1000 Peak	16.1	46.6

Load Mismatch/Ruggedness

Frequency (MHz)	Signal Type	VSWR	P_{in} (W)	Test Voltage	Result
1400 (1)	Pulse (128 μ sec, 10% Duty Cycle)	> 20:1 at All Phase Angles	31.6 Peak (3 dB Overdrive)	50	No Device Degradation

1. Measured in 1400 MHz narrowband production circuit.

Features

- Internally Input and Output Matched for Broadband Operation and Ease of Use
- Device Can Be Used in a Single-Ended, Push-Pull or Quadrature Configuration
- Qualified up to a Maximum of 50 V_{DD} Operation
- High Ruggedness, Handles > 20:1 VSWR
- Integrated ESD Protection with Greater Negative Voltage Range for Improved Class C Operation and Gate Voltage Pulsing
- Characterized with Series Equivalent Large-Signal Impedance Parameters

Typical Applications

- Commercial L-Band Radar Systems

**AFV141KH
 AFV141KHS
 AFV141KGS**

**1200–1400 MHz, 1000 W PEAK, 50 V
 AIRFAST RF POWER LDMOS
 TRANSISTORS**

NI-1230H-4S
 AFV141KH

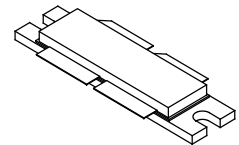

NI-1230S-4S
 AFV141KHS

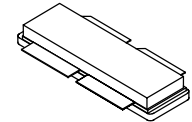

NI-1230GS-4L
 AFV141KGS

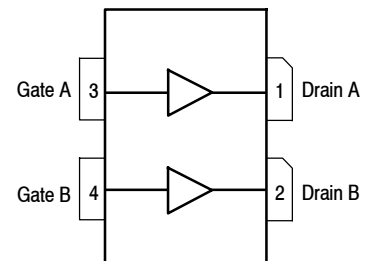
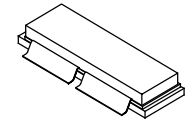

(Top View)

Note: The backside of the package is the source terminal for the transistor.

Figure 1. Pin Connections



Table 1. Maximum Ratings

Rating	Symbol	Value	Unit
Drain-Source Voltage	V_{DSS}	-0.5, +105	Vdc
Gate-Source Voltage	V_{GS}	-6.0, +10	Vdc
Storage Temperature Range	T_{stg}	-65 to +150	°C
Case Operating Temperature Range	T_C	-40 to +150	°C
Operating Junction Temperature Range (1,2)	T_J	-40 to +225	°C
Total Device Dissipation @ $T_C = 25^\circ\text{C}$ Derate above 25°C	P_D	910 4.55	W W/°C

Table 2. Thermal Characteristics

Characteristic	Symbol	Value (2,3)	Unit
Thermal Impedance, Junction to Case Case Temperature 60°C, 1000 W Peak, 128 μsec Pulse Width, 10% Duty Cycle, 50 Vdc, $I_{DQ(A+B)} = 100\text{ mA}$, 1400 MHz	$Z_{\theta JC}$	0.018	°C/W

Table 3. ESD Protection Characteristics

Test Methodology	Class
Human Body Model (per JESD22-A114)	2, passes 2500 V
Machine Model (per EIA/JESD22-A115)	B, passes 200 V
Charge Device Model (per JESD22-C101)	IV, passes 2000 V

Table 4. Electrical Characteristics ($T_A = 25^\circ\text{C}$ unless otherwise noted)

Characteristic	Symbol	Min	Typ	Max	Unit
----------------	--------	-----	-----	-----	------

Off Characteristics (4)

Gate-Source Leakage Current ($V_{GS} = 5\text{ Vdc}$, $V_{DS} = 0\text{ Vdc}$)	I_{GSS}	—	—	1	μAdc
Drain-Source Breakdown Voltage ($V_{GS} = 0\text{ Vdc}$, $I_D = 10\ \mu\text{Adc}$)	$V_{(BR)DSS}$	105	—	—	Vdc
Zero Gate Voltage Drain Leakage Current ($V_{DS} = 50\text{ Vdc}$, $V_{GS} = 0\text{ Vdc}$)	I_{DSS}	—	—	1	μAdc
Zero Gate Voltage Drain Leakage Current ($V_{DS} = 105\text{ Vdc}$, $V_{GS} = 0\text{ Vdc}$)	I_{DSS}	—	—	10	μAdc

On Characteristics

Gate Threshold Voltage (4) ($V_{DS} = 10\text{ Vdc}$, $I_D = 520\ \mu\text{Adc}$)	$V_{GS(th)}$	1.3	1.8	2.3	Vdc
Gate Quiescent Voltage (5) ($V_{DD} = 50\text{ Vdc}$, $I_{DQ(A+B)} = 100\text{ mAdc}$, Measured in Functional Test)	$V_{GS(Q)}$	1.6	2.1	2.6	Vdc
Drain-Source On-Voltage (4) ($V_{GS} = 10\text{ Vdc}$, $I_D = 2.6\text{ Adc}$)	$V_{DS(on)}$	0.05	0.16	0.35	Vdc

Dynamic Characteristics (5)

Reverse Transfer Capacitance ($V_{DS} = 50\text{ Vdc} \pm 30\text{ mV(rms)ac}$ @ 1 MHz, $V_{GS} = 0\text{ Vdc}$)	C_{rss}	—	2.98	—	pF
---	-----------	---	------	---	----

1. Continuous use at maximum temperature will affect MTTF.
2. MTTF calculator available at <http://www.nxp.com/RF/calculators>.
3. Refer to AN1955, *Thermal Measurement Methodology of RF Power Amplifiers*. Go to <http://www.nxp.com/RF> and search for AN1955.
4. Each side of device measured separately.
5. Measurement made with device in push-pull configuration.

(continued)

Table 4. Electrical Characteristics ($T_A = 25^\circ\text{C}$ unless otherwise noted) (continued)

Characteristic	Symbol	Min	Typ	Max	Unit
Functional Tests ^(1,2) (In Freescale Narrowband Production Test Fixture, 50 ohm system) $V_{DD} = 50\text{ Vdc}$, $I_{DQ(A+B)} = 100\text{ mA}$, $P_{out} = 1000\text{ W Peak}$ (100 W Avg.), $f = 1400\text{ MHz}$, 128 μsec Pulse Width, 10% Duty Cycle					
Power Gain	G_{ps}	16.0	17.7	19.5	dB
Drain Efficiency	η_D	46.0	52.1	—	%
Input Return Loss	IRL	—	-18	-9	dB

Load Mismatch/Ruggedness (In Freescale Narrowband Test Fixture, 50 ohm system) $I_{DQ(A+B)} = 100\text{ mA}$

Frequency (MHz)	Signal Type	VSWR	P_{in} (W)	Test Voltage, V_{DD}	Result
1400	Pulse (128 μsec , 10% Duty Cycle)	> 20:1 at all Phase Angles	31.6 Peak (3 dB Overdrive)	50	No Device Degradation

Table 5. Ordering Information

Device	Tape and Reel Information	Package
AFV141KHR5	R5 Suffix = 50 Units, 56 mm Tape Width, 13-inch Reel	NI-1230H-4S, Eared
AFV141KHSR5		NI-1230S-4S, Earless
AFV141KGSR5		NI-1230GS-4L, Gull Wing

1. Measurement made with device in push-pull configuration.
2. Measurements made with device in straight lead configuration before any lead forming operation is applied. Lead forming is used for gull wing (GS) parts.

TYPICAL CHARACTERISTICS



Note: Each side of device measured separately.
Figure 2. Capacitance versus Drain-Source Voltage

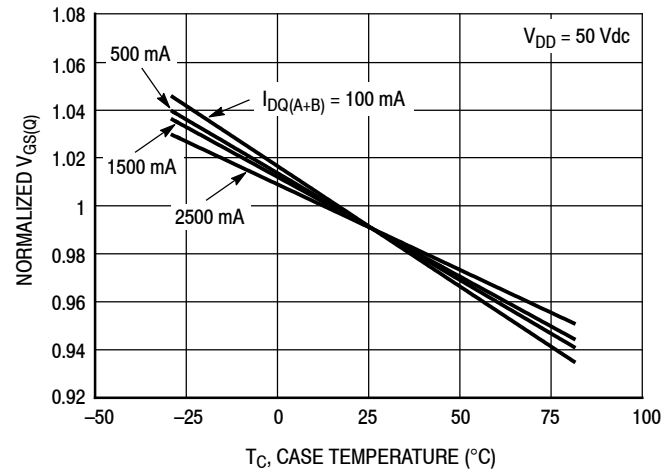

I_{DQ} (mA)	Slope (mV/°C)
100	-2.06
500	-1.96
1500	-1.94
2500	-1.72

Figure 3. Normalized V_{GS} versus Quiescent Current and Case Temperature

1400 MHz NARROWBAND PRODUCTION TEST FIXTURE — 4" x 6" (10.2 cm x 15.2 cm)

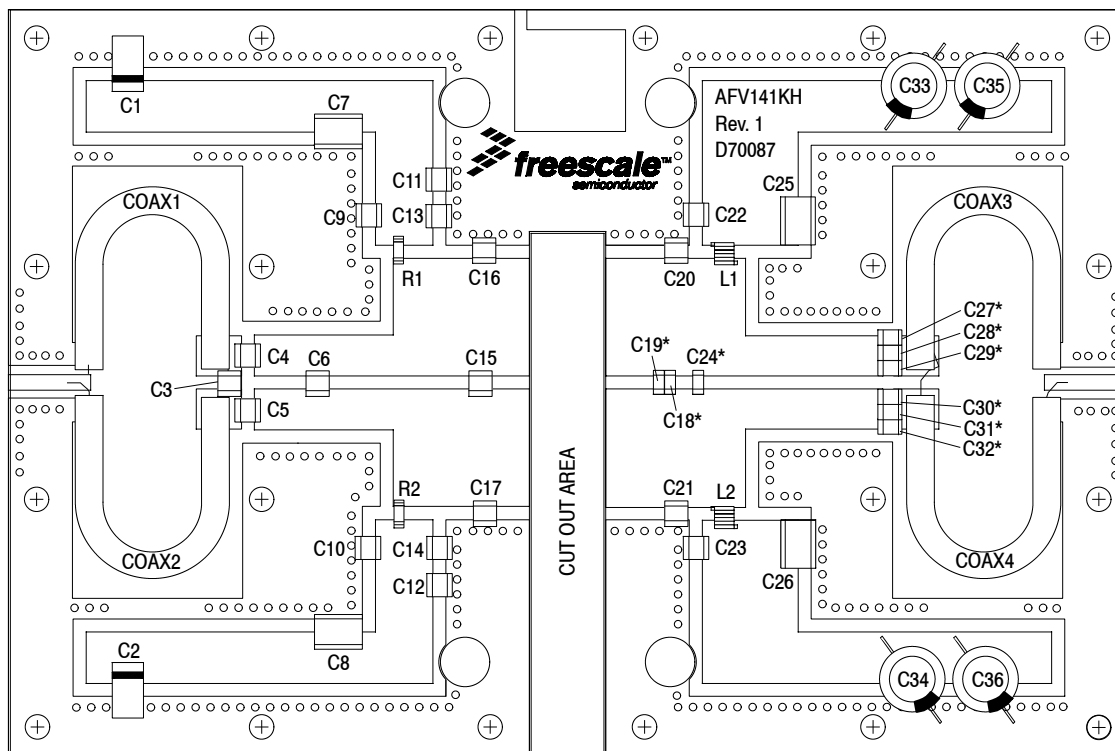

* C18, C19, C24, C27, C28, C29, C30, C31 and C32 are mounted vertically.

Figure 4. AFV141KH(HS) Narrowband Test Circuit Component Layout — 1400 MHz

Table 6. AFV141KH(HS) 1400 MHz Narrowband Circuit Component Designations and Values

Part	Description	Part Number	Manufacturer
C1, C2	22 μ F, 35 V Tantalum Capacitors	T491X226K035AT	Kemet
C3	2.7 pF Chip Capacitor	ATC100B2R7BT500XT	ATC
C4, C5, C9, C10, C13, C14, C22, C23	27 pF Chip Capacitors	ATC100B270JT500XT	ATC
C6	1.5 pF Chip Capacitor	ATC100B1R5BT500XT	ATC
C7, C8	2.2 μ F Chip Capacitors	C1825C225J5RACTU	Kemet
C11, C12	0.1 μ F Chip Capacitors	CDR33BX104AKY9S	AVX
C15	2.2 pF Chip Capacitor	ATC100B2R2BT500XT	ATC
C16, C17	0.7 pF Chip Capacitors	ATC100B0R7BT500XT	ATC
C18	1.5 pF Chip Capacitor	ATC100B1R5BT500XT	ATC
C19	1.2 pF Chip Capacitor	ATC100B1R2BT500XT	ATC
C20, C21	2.2 pF Chip Capacitors	ATC100B2R2BT500XT	ATC
C24	1.5 pF Chip Capacitor	ATC100B1R5BT500XT	ATC
C25, C26	0.01 μ F Chip Capacitors	C1825C103K1GACTU	Kemet
C27, C28, C29, C30, C31, C32	27 pF Chip Capacitors	ATC100B270JT500XT	ATC
C33, C34, C35, C36	470 μ F, 63 V Electrolytic Capacitors	MCGPR63V477M13X26-RH	Multicomp
Coax1, Coax2, Coax3, Coax4	35 Ω Semi Rigid Coax 1.454" Shield Length	HSF-141-35-C	Hongsen Cable
L1, L2	17.5 nH, 4 Turn Inductors	GA3095-ALC	Coilcraft
R1, R2	100 Ω , 1 W Chip Resistors	CRCW2512100RFKEG	Vishay
PCB	Arlon AD255A, 0.03", $\epsilon_r = 2.55$	D70087	MTL

TYPICAL CHARACTERISTICS — 1400 MHz PRODUCTION TEST FIXTURE

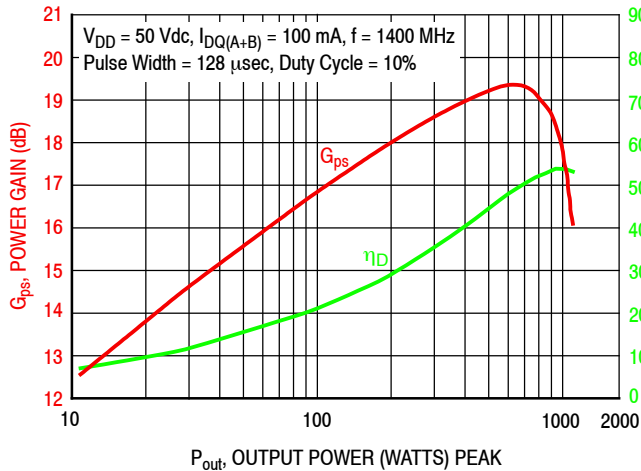
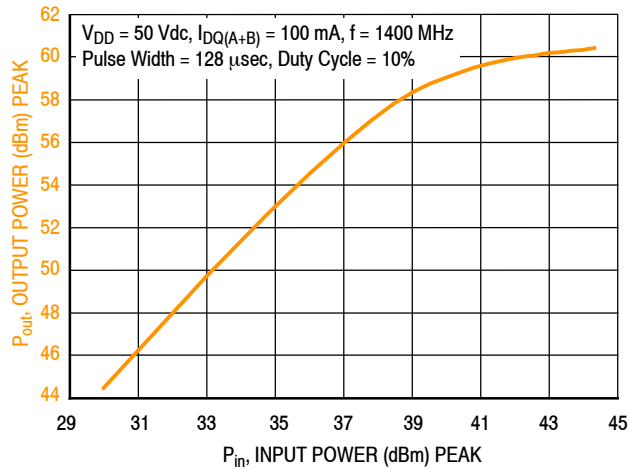

Figure 5. Power Gain and Drain Efficiency versus Output Power



f (MHz)	P1dB (W)	P3dB (W)
1400	948	1079

Figure 6. Output Power versus Input Power

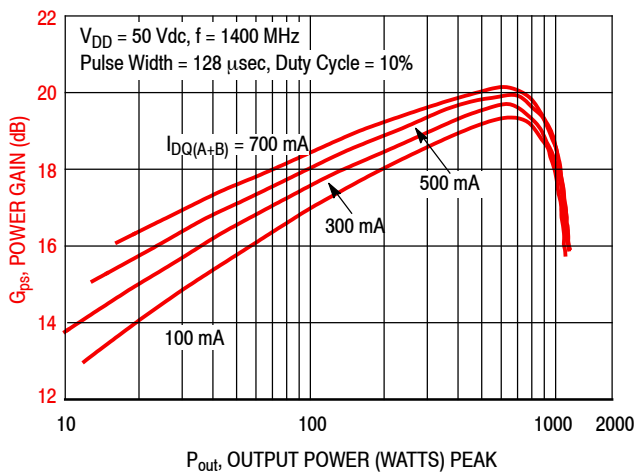

Figure 7. Power Gain versus Output Power

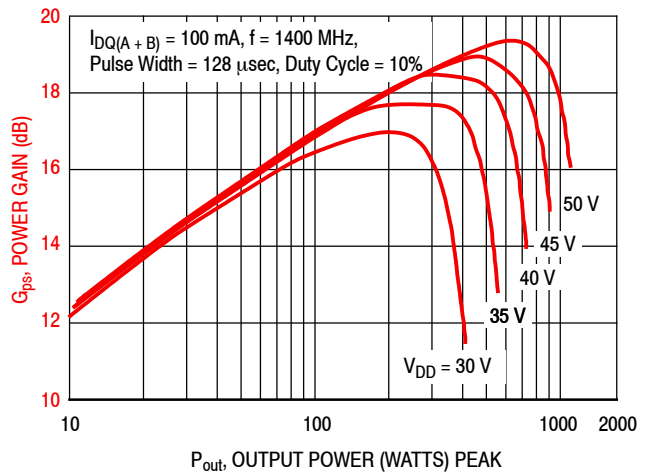

Figure 8. Power Gain versus Output Power

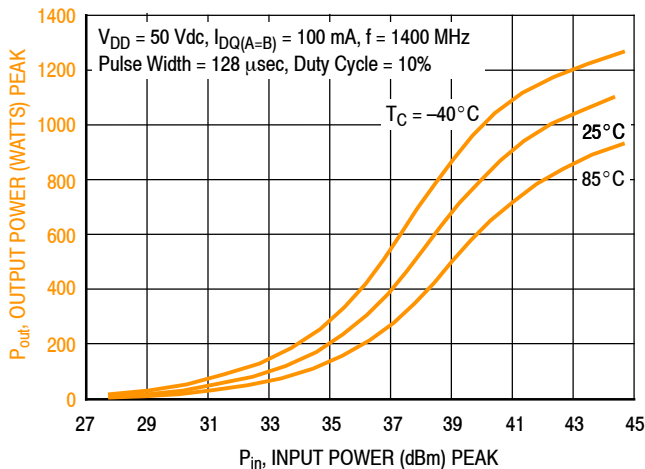

Figure 9. Output Power versus Input Power

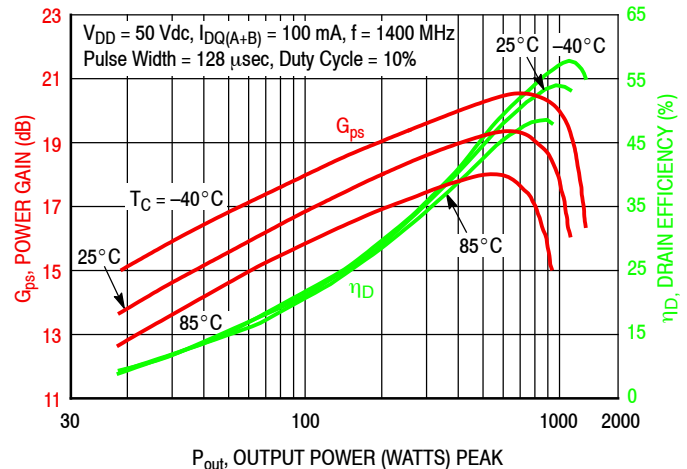

Figure 10. Power Gain and Drain Efficiency versus Output Power

1400 MHz NARROWBAND PRODUCTION TEST FIXTURE

f MHz	Z_{source} Ω	Z_{load} Ω
1400	$7.35 - j4.62$	$1.3 - j.072$

Z_{source} = Test circuit impedance as measured from gate to gate, balanced configuration.

Z_{load} = Test circuit impedance as measured from drain to drain, balanced configuration.

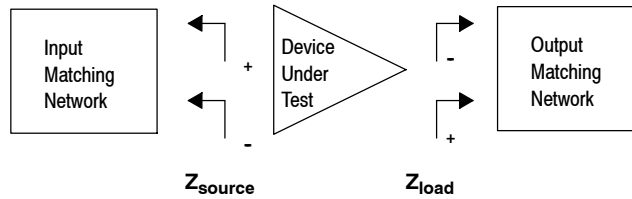
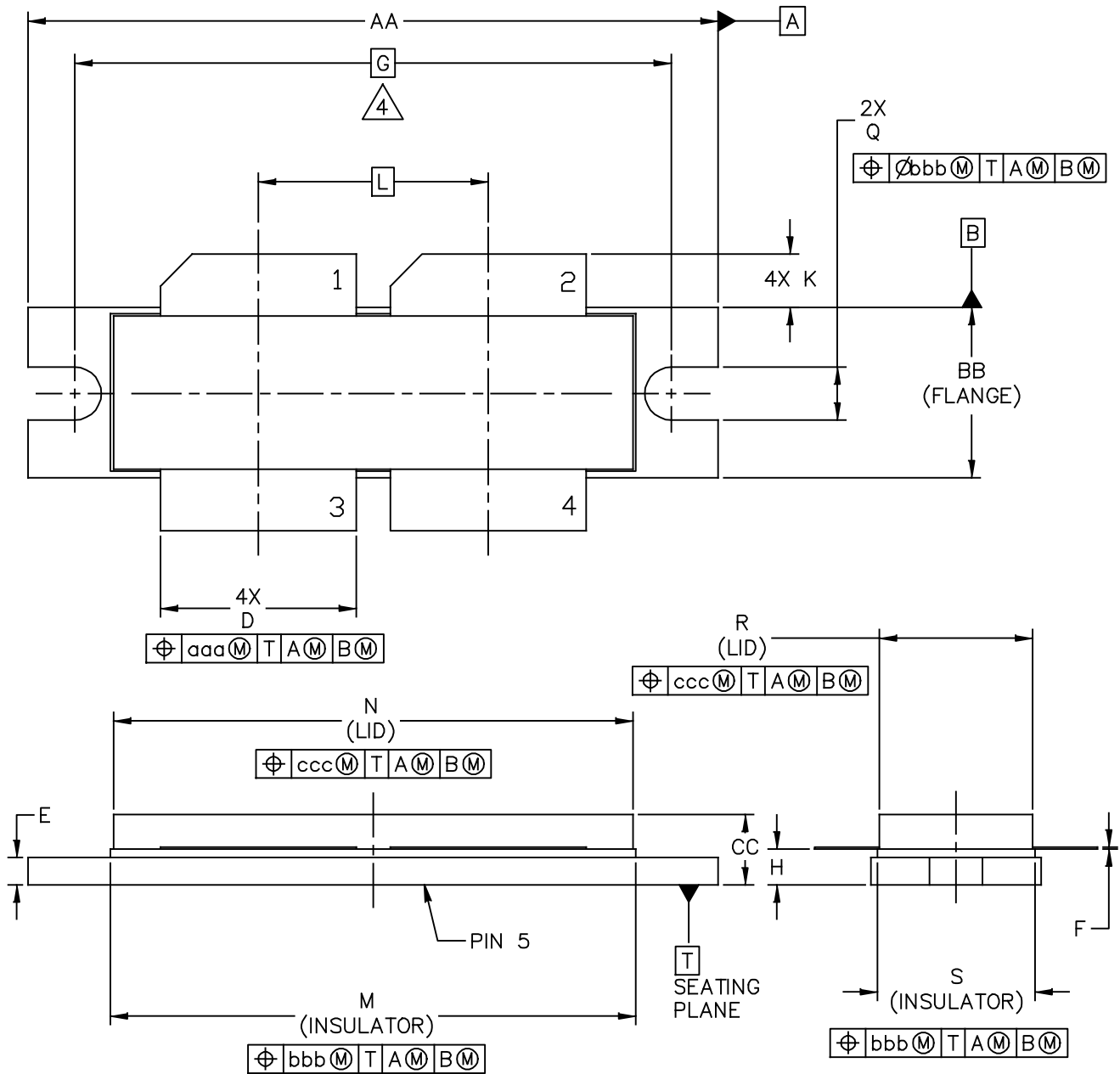

Figure 11. Narrowband Series Equivalent Source and Load Impedance — 1400 MHz

PACKAGE DIMENSIONS



© NXP SEMICONDUCTORS N.V. ALL RIGHTS RESERVED	MECHANICAL OUTLINE	PRINT VERSION NOT TO SCALE
TITLE: NI-1230-4H	DOCUMENT NO: 98ASB16977C STANDARD: NON-JEDEC SOT1787-1	REV: G 03 MAR 2016

NOTES:

1. INTERPRET DIMENSIONS AND TOLERANCES PER ASME Y14.5M-1994.
2. CONTROLLING DIMENSION: INCH
3. DIMENSION H IS MEASURED .030 INCH (0.762 MM) AWAY FROM PACKAGE BODY.
4. RECOMMENDED BOLT CENTER DIMENSION OF 1.52 INCH (38.61 MM) BASED ON M3 SCREW.

DIM	INCH		MILLIMETER		DIM	INCH		MILLIMETER	
	MIN	MAX	MIN	MAX		MIN	MAX	MIN	MAX
AA	1.615	1.625	41.02	41.28	N	1.218	1.242	30.94	31.55
BB	.395	.405	10.03	10.29	Q	.120	.130	3.05	3.30
CC	.170	.190	4.32	4.83	R	.355	.365	9.02	9.27
D	.455	.465	11.56	11.81	S	.365	.375	9.27	9.53
E	.062	.066	1.57	1.68					
F	.004	.007	0.10	0.18					
G	1.400 BSC		35.56 BSC		aaa	.013		0.33	
H	.082	.090	2.08	2.29	bbb	.010		0.25	
K	.117	.137	2.97	3.48	ccc	.020		0.51	
L	.540 BSC		13.72 BSC						
M	1.219	1.241	30.96	31.52					
© NXP SEMICONDUCTORS N.V. ALL RIGHTS RESERVED			MECHANICAL OUTLINE			PRINT VERSION NOT TO SCALE			
TITLE:					DOCUMENT NO: 98ASB16977C REV: G				
NI-1230-4H					STANDARD: NON-JEDEC				
					SOT1787-1		03 MAR 2016		

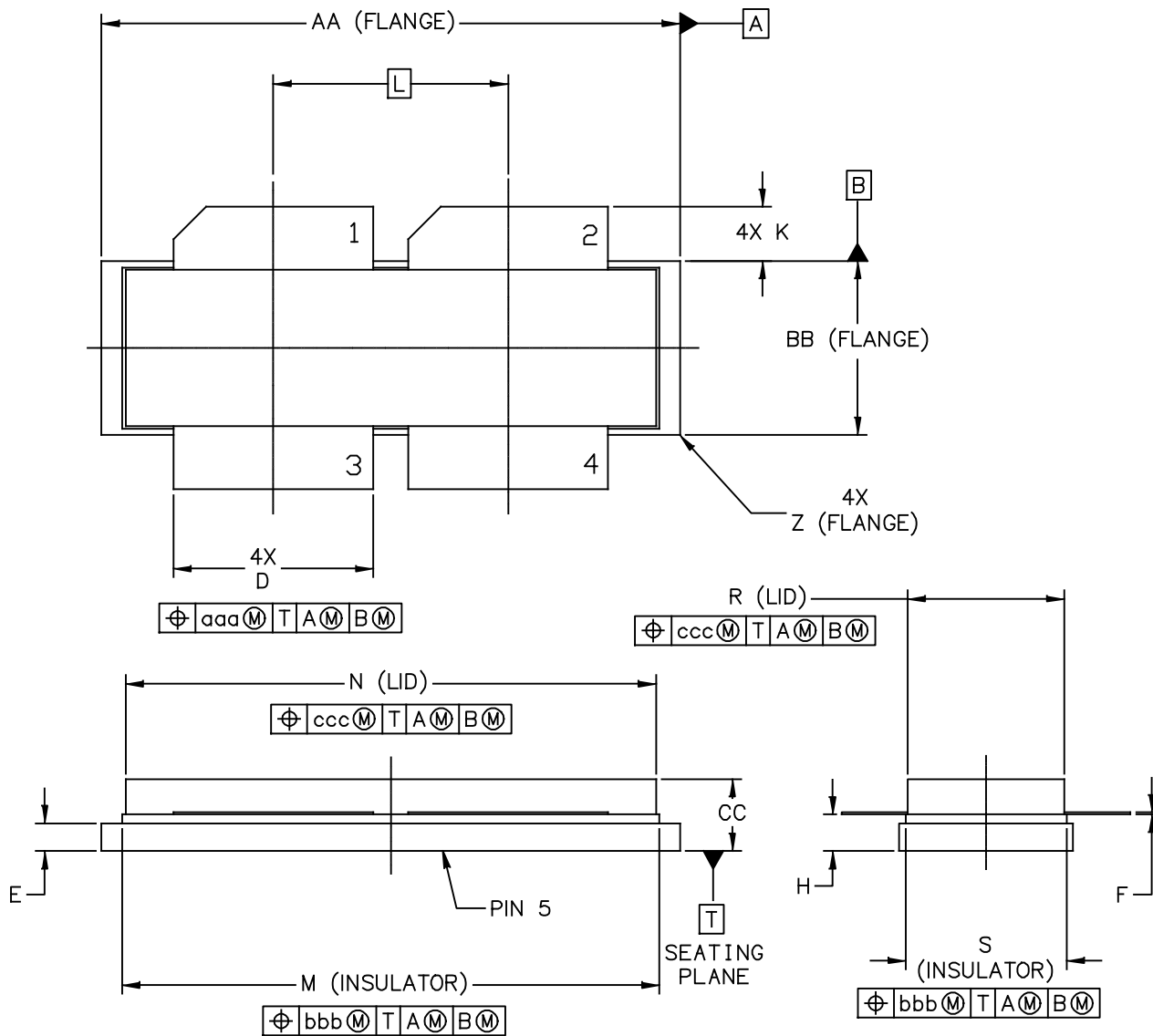

© NXP SEMICONDUCTORS N. V. ALL RIGHTS RESERVED	MECHANICAL OUTLINE	PRINT VERSION NOT TO SCALE
TITLE: NI-1230-4S	DOCUMENT NO: 98ARB18247C	REV: H
	STANDARD: NON-JEDEC	
	SOT1829-1	19 FEB 2016

NOTES:

1. INTERPRET DIMENSIONS AND TOLERANCES PER ASME Y14.5M-1994.
2. CONTROLLING DIMENSION: INCH
3. DIMENSION H IS MEASURED .030 INCH (0.762 MM) AWAY FROM PACKAGE BODY

DIM	INCHES		MILLIMETERS		DIM	INCHES		MILLIMETERS	
	MIN	MAX	MIN	MAX		MIN	MAX	MIN	MAX
AA	1.265	1.275	32.13	32.39	R	.355	.365	9.02	9.27
BB	.395	.405	10.03	10.29	S	.365	.375	9.27	9.53
CC	.170	.190	4.32	4.83	Z	R.000	R.040	R0.00	R1.02
D	.455	.465	11.56	11.81					
E	.062	.066	1.57	1.68	aaa	.013		0.33	
F	.004	.007	0.10	0.18	bbb	.010		0.25	
H	.082	.090	2.08	2.29	ccc	.020		0.51	
K	.117	.137	2.97	3.48					
L	.540 BSC		13.72 BSC						
M	1.219	1.241	30.96	31.52					
N	1.218	1.242	30.94	31.55					
© NXP SEMICONDUCTORS N.V. ALL RIGHTS RESERVED			MECHANICAL OUTLINE			PRINT VERSION NOT TO SCALE			
TITLE: NI-1230-4S					DOCUMENT NO: 98ARB18247C REV: H				
					STANDARD: NON-JEDEC				
					SOT1829-1			19 FEB 2016	

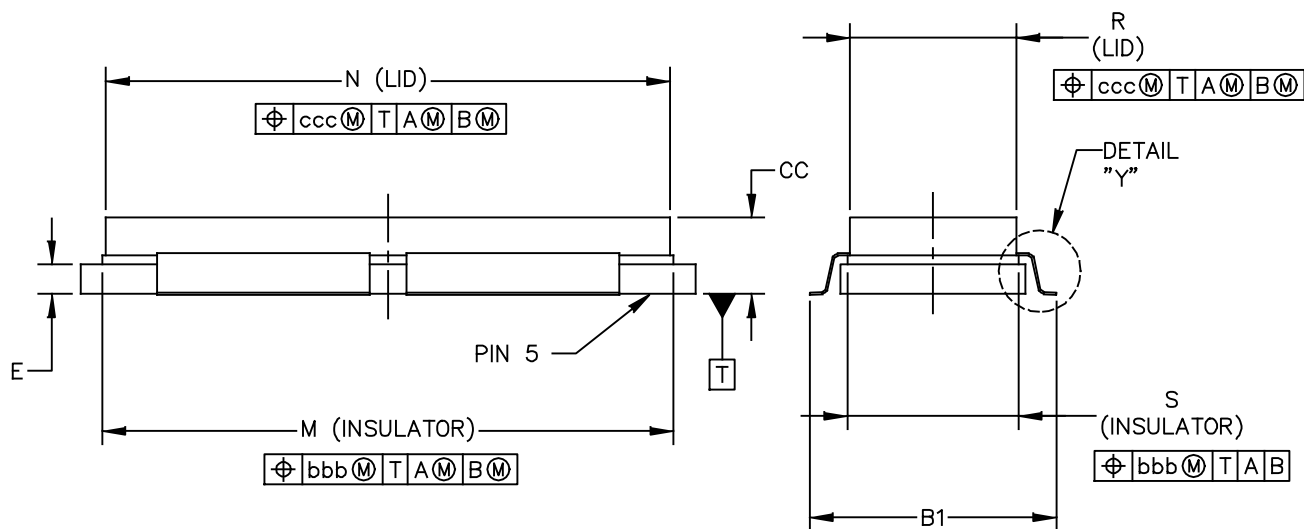
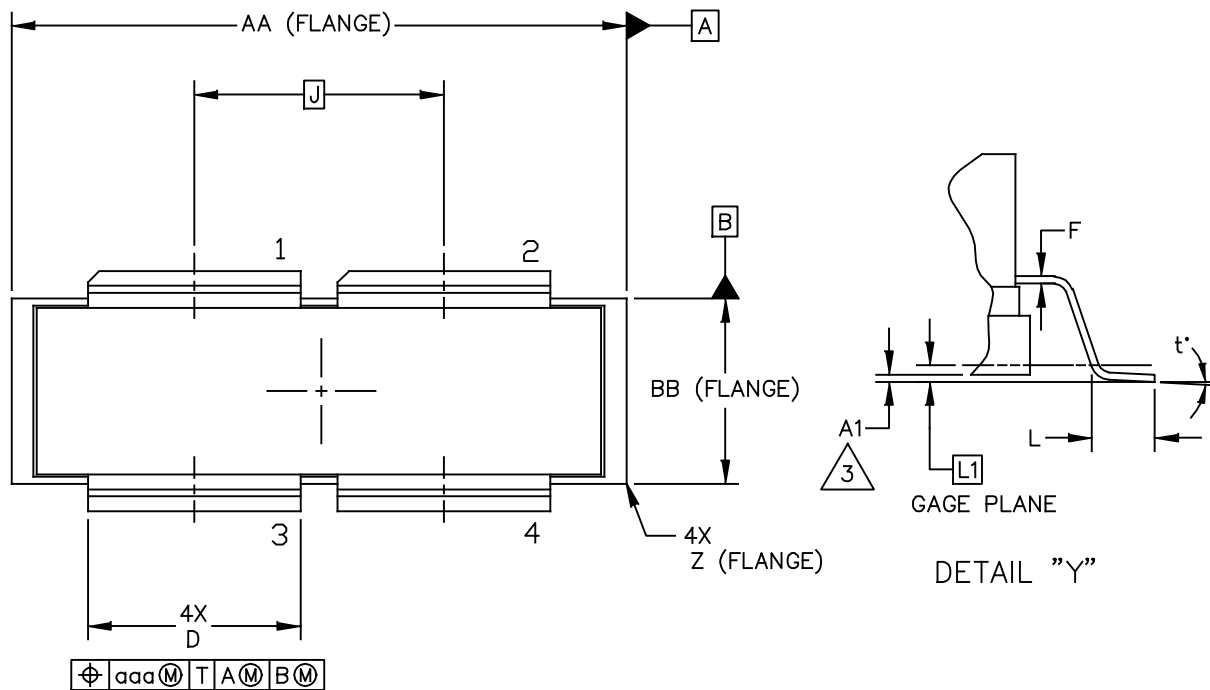

© NXP SEMICONDUCTORS N. V. ALL RIGHTS RESERVED	MECHANICAL OUTLINE	PRINT VERSION NOT TO SCALE
TITLE: NI-1230-4S GULL	DOCUMENT NO: 98ASA00459D	REV: B
	STANDARD: NON-JEDEC	
	SOT1806-2	23 FEB 2016

NOTES:

1. INTERPRET DIMENSIONS AND TOLERANCES PER ASME Y14.5M-1994.
2. CONTROLLING DIMENSION: INCH

3. DIMENSION A1 IS MEASURED WITH REFERENCE TO DATUM T. THE POSITIVE VALUE IMPLIES THAT THE PACKAGE BOTTOM IS HIGHER THAN THE LEAD BOTTOM.

DIM	INCHES		MILLIMETERS		DIM	INCHES		MILLIMETERS	
	MIN	MAX	MIN	MAX		MIN	MAX	MIN	MAX
AA	1.265	1.275	32.13	32.39	R	.355	.365	9.02	9.27
A1	-.001	.011	-0.03	0.28	S	.365	.375	9.27	9.53
BB	.395	.405	10.03	10.29	Z	R.000	R.040	R0.00	R1.02
B1	.564	.574	14.32	14.58	t*	0*	8*	0*	8*
CC	.170	.190	4.32	4.83					
D	.455	.465	11.56	11.81	aaa	.013		0.33	
E	.062	.066	1.57	1.68	bbb	.010		0.25	
F	.004	.007	0.10	0.18	ccc	.020		0.51	
J	.540 BSC		13.72 BSC						
L	.038	.046	0.97	1.17					
L1	.01 BSC		0.25 BSC						
M	1.219	1.241	30.96	31.52					
N	1.218	1.242	30.94	31.55					
© NXP SEMICONDUCTORS N.V. ALL RIGHTS RESERVED			MECHANICAL OUTLINE			PRINT VERSION NOT TO SCALE			
TITLE: NI-1230-4S GULL					DOCUMENT NO: 98ASA00459D REV: B				
					STANDARD: NON-JEDEC				
					SOT1806-2			23 FEB 2016	

PRODUCT DOCUMENTATION, SOFTWARE AND TOOLS

Refer to the following resources to aid your design process.

Application Notes

- AN1908: Solder Reflow Attach Method for High Power RF Devices in Air Cavity Packages
- AN1955: Thermal Measurement Methodology of RF Power Amplifiers

Engineering Bulletins

- EB212: Using Data Sheet Impedances for RF LDMOS Devices

Software

- Electromigration MTTF Calculator
- RF High Power Model
- .s2p File

Development Tools

- Printed Circuit Boards

To Download Resources Specific to a Given Part Number:

1. Go to <http://www.nxp.com/RF>
2. Search by part number
3. Click part number link
4. Choose the desired resource from the drop down menu

REVISION HISTORY

The following table summarizes revisions to this document.

0	Apr. 2016	• Initial Release of Data Sheet
---	-----------	---------------------------------

How to Reach Us:

Home Page:
freescale.com

Web Support:
freescale.com/support

Information in this document is provided solely to enable system and software implementers to use Freescale products. There are no express or implied copyright licenses granted hereunder to design or fabricate any integrated circuits based on the information in this document.

Freescale reserves the right to make changes without further notice to any products herein. Freescale makes no warranty, representation, or guarantee regarding the suitability of its products for any particular purpose, nor does Freescale assume any liability arising out of the application or use of any product or circuit, and specifically disclaims any and all liability, including without limitation consequential or incidental damages. "Typical" parameters that may be provided in Freescale data sheets and/or specifications can and do vary in different applications, and actual performance may vary over time. All operating parameters, including "typicals," must be validated for each customer application by customer's technical experts. Freescale does not convey any license under its patent rights nor the rights of others. Freescale sells products pursuant to standard terms and conditions of sale, which can be found at the following address: freescale.com/SalesTermsandConditions.

Freescale and the Freescale logo are trademarks of Freescale Semiconductor, Inc., Reg. U.S. Pat. & Tm. Off. Airfast is a trademark of Freescale Semiconductor, Inc. All other product or service names are the property of their respective owners.

© 2016 Freescale Semiconductor, Inc.

