



Main

Range of product	OsiSense XCC
Encoder type	Incremental encoder
Encoder name	XCC
Product specific application	-
Diameter	2.28 in (58 mm)
Shaft diameter	0.55 in (14 mm)
Shaft type	Through shaft
Resolution	100 points
Output stage	Type Y
Type of output stage	Driver push-pull
Electrical connection	1 male connector M23 radial 12 pins
[Us] rated supply voltage	5...30 V DC
Enclosure material	Zamak

Complementary

Shaft tolerance	H7
Residual ripple	500 mV
Maximum revolution speed	6000 rpm
Shaft moment of inertia	0.01 lb.in ² (22 g.cm ²)
Torque value	0.05 lbf.in (0.006 N.m)
Maximum load	2 daN axial 5 daN radial
Output frequency	300 kHz
Number of channels	3
Current consumption	0...75 mA (no-load)
Protection type	Reverse polarity protection Short-circuit protection
Maximum output current	40 mA
Output level	Low level: 0.5 V maximum (20 mA) High level: V supply - 2.5 V minimum (20 mA)
Surge withstand	1 kV, level 2 conforming to IEC 61000-4-5
Base material	Aluminium
Shaft material	Stainless steel
Type of ball bearings	6803ZZ
Product weight	0.96 lb(US) (0.435 kg)

Environment

marking	CE
ambient air temperature for operation	-22...212 °F (-30...100 °C)
ambient air temperature for storage	-22...185 °F (-30...85 °C)
IP degree of protection	IP65 conforming to IEC 60529
vibration resistance	10 gn (f = 55...2000 Hz) conforming to IEC 60068-2-6
shock resistance	30 gn 11 ms conforming to IEC 60068-2-27
resistance to electrostatic discharge	8 kV (air discharge) level 3 conforming to IEC 61000-4-2 4 kV (contact discharge) level 3 conforming to IEC 61000-4-2
resistance to electromagnetic fields	9.14 V/yd (10 V/m) level 3 conforming to IEC 61000-4-3
resistance to fast transients	1 kV (signal ports) level 3 conforming to IEC 61000-4-4 2 kV (power ports) level 3 conforming to IEC 61000-4-4

The information provided in this documentation contains general descriptions and/or technical characteristics of the performance of the products contained herein. This documentation is not intended as a substitute for and is not to be used for determining suitability or reliability of these products for specific user applications. It is the duty of any such user or integrator to perform the appropriate and complete risk analysis, evaluation and testing of the products with respect to the relevant specific application or use thereof. Neither Schneider Electric Industries SAS nor any of its affiliates or subsidiaries shall be responsible or liable for misuse of the information contained herein.

Offer Sustainability

Not Green Premium product	Not Green Premium product
Compliant - since 0701 - Schneider Electric declaration of conformity	Compliant - since 0701 - Schneider Electric declaration of conformity
Reference not containing SVHC above the threshold	Reference not containing SVHC above the threshold
WARNING: This product can expose you to chemicals including:	WARNING: This product can expose you to chemicals including:
Diisononyl phthalate (DINP), which is known to the State of California to cause cancer, and	Diisononyl phthalate (DINP), which is known to the State of California to cause cancer, and
Di-isodecyl phthalate (DIDP), which is known to the State of California to cause birth defects or other reproductive harm.	Di-isodecyl phthalate (DIDP), which is known to the State of California to cause birth defects or other reproductive harm.
For more information go to www.p65warnings.ca.gov	For more information go to www.p65warnings.ca.gov

Contractual warranty

Warranty period	18 months
-----------------	-----------

Dimensions

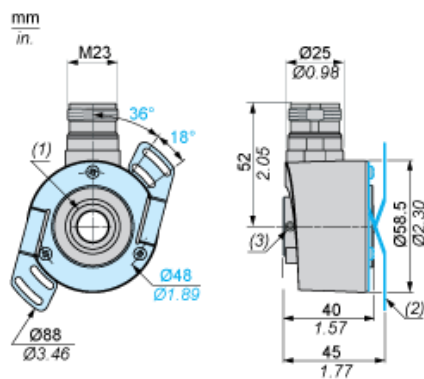

- (1) Through shaft, Ø 14 (H7)
- (2) Flexible mounting kit, 1 x XCCRF5N mounted
- (3) 2 HC M4 x 4 locking screws

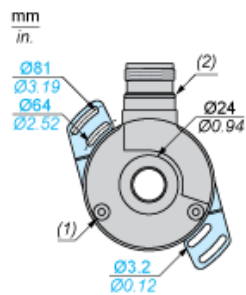

- (1) Hole for M3 x 6 self-threading screw
- (2) Nitrile seal

Wiring Diagram

Type Y Output Stage

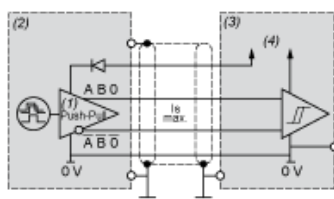

- (1) RS 422 compatible on 5 V supply
- (2) Encoder
- (3) Processing
- (4) Supply 5 V/30 V

Wiring Diagram

M23, 12-pin Connector Connections

Male Connector on Encoder

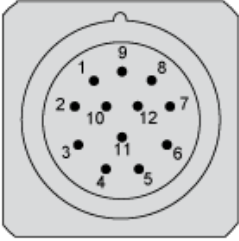

Pin number	1	2	3	4	5	6	7	8	9	10	11	12
Signal Supply	A ⁻	+V	0	0 ⁻	B	B ⁻	R	A	R	0 V	0 V	+V

R = reserved, do not connect