

# Single 500Mbps LVDS Line Receiver in SC70

## General Description

The MAX9130 is a single low-voltage differential signaling (LVDS) line receiver ideal for applications requiring high data rates, low power, and low noise. The device is guaranteed to receive data at speeds up to 500Mbps (250MHz).

The MAX9130 accepts an LVDS differential input and translates it to an LVTTTL/LVCMOS output. The fail-safe feature sets the output high when the inputs are undriven and open, terminated, or shorted. The device supports a wide common-mode input range, allowing a ground potential difference and common-mode noise between the driver and the receiver. The MAX9130 conforms to the ANSI/TIA/EIA-644 LVDS standard.

The MAX9130 operates from a single +3.3V supply, and is specified for operation from -40°C to +85°C. It is available in a space-saving 6-pin SC70 package. Refer to the MAX9110/MAX9112 data sheet for single/dual LVDS line drivers. Refer to the MAX9115 for a lower speed (200Mbps) single LVDS line receiver in SC70.

## Applications

Clock Distribution  
Cellular Phone Base Stations  
Digital Cross-Connects  
Network Switches/Routers  
DSLAMs

## Typical Application Circuit

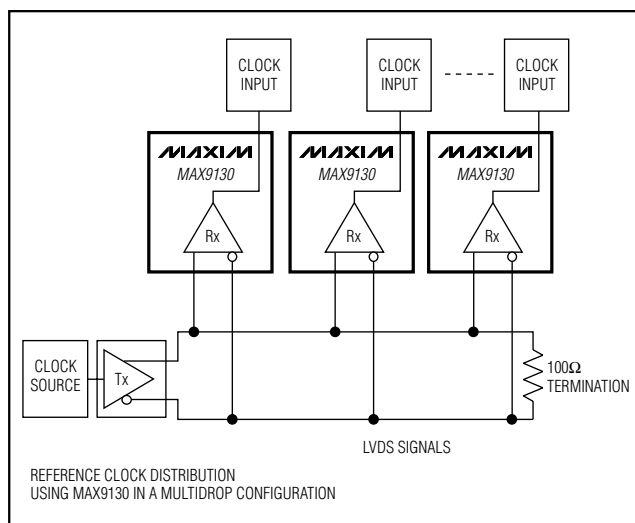

## Features

- ◆ Space-Saving SC70 Package (50% Smaller than SOT23)
- ◆ Guaranteed 500Mbps Data Rate
- ◆ Low 250ps (max) Pulse Skew
- ◆ High-Impedance LVDS Inputs When Powered Off Allow Hot Swapping
- ◆ Conforms to ANSI TIA/EIA-644 LVDS Standard
- ◆ Single +3.3V Supply
- ◆ Fail-Safe Circuit Sets Output High for Undriven Inputs (Open, Terminated, or Shorted)
- ◆ Low 150μA (typ) Supply Current in Fail-Safe Mode

## Ordering Information

PART	TEMP. RANGE	PIN-PACKAGE	TOP MARK
MAX9130EXT-T	-40°C to +85°C	6 SC70-6	ABB

## Pin Configuration

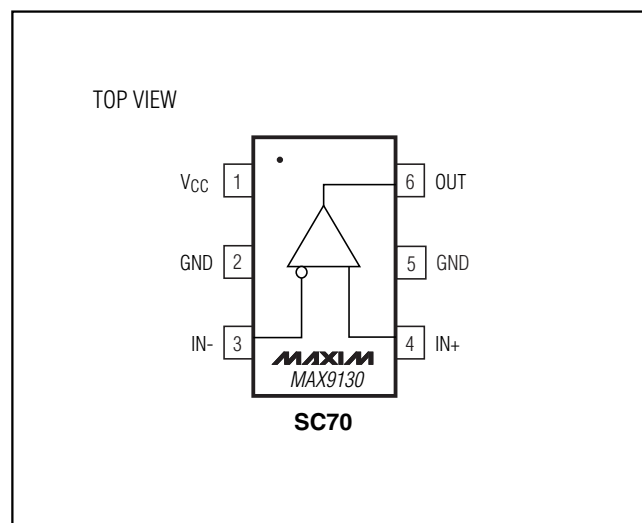

# Single 500Mbps LVDS Line Receiver in SC70

## ABSOLUTE MAXIMUM RATINGS

V <sub>CC</sub> to GND	.....-0.3V to +4.0V	Maximum Junction Temperature	.....+150°C
IN+, IN- to GND	.....-0.3V to +4.0V	Operating Temperature Range	.....-40°C to +85°C
OUT to GND	.....-0.3V to (V <sub>CC</sub> + 0.3V)	ESD Protection	
Continuous Power Dissipation (T <sub>A</sub> = +70°C)		Human Body Model (IN+, IN-)	.....±6kV
6-Pin SC70 (derate 3.1mW/°C above +70°C)	.....245 mW	Lead Temperature (soldering, 10s)	.....+300°C
Output Short to GND (OUT) (Note 1)	.....1s		
Storage Temperature Range	.....-65°C to +150°C		

**Note 1:** Package leads soldered to a PC board having copper ground and V<sub>CC</sub> planes. Do not exceed Maximum Junction Temperature.

Stresses beyond those listed under "Absolute Maximum Ratings" may cause permanent damage to the device. These are stress ratings only, and functional operation of the device at these or any other conditions beyond those indicated in the operational sections of the specifications is not implied. Exposure to absolute maximum rating conditions for extended periods may affect device reliability.

## DC ELECTRICAL CHARACTERISTICS

(V<sub>CC</sub> = +3.0V to +3.6V, differential input voltage |V<sub>ID</sub>| = 0.05V to 1.0V, input common voltage V<sub>CM</sub> = |V<sub>ID</sub>|/2 to 2.4V - |V<sub>ID</sub>|/2, T<sub>A</sub> = -40°C to +85°C, unless otherwise noted. Typical values at V<sub>CC</sub> = +3.3V, T<sub>A</sub> = +25°C.) (Notes 2, 3)

PARAMETER	SYMBOL	CONDITIONS	MIN	TYP	MAX	UNITS
<b>LVDS INPUTS (IN+, IN-)</b>						
Differential Input High Threshold	V <sub>TH</sub>				50	mV
Differential Input Low Threshold	V <sub>TL</sub>		-50			mV
Input Current	I <sub>IN+</sub> , I <sub>IN-</sub>	0.05V ≤  V <sub>ID</sub>   ≤ 0.6V	-20		20	μA
		0.6V <  V <sub>ID</sub>   ≤ 1.0V	-25		25	
Power-Off Input Current	I <sub>INO</sub>	0.05V ≤  V <sub>ID</sub>   ≤ 0.6V, V <sub>CC</sub> = 0	-20		20	μA
		0.6V <  V <sub>ID</sub>   ≤ 1.0V, V <sub>CC</sub> = 0	-25		25	
Input Resistance	R <sub>IN1</sub>	V <sub>CC</sub> = +3.6V or 0, Figure 1	35			kΩ
	R <sub>IN2</sub>	V <sub>CC</sub> = +3.6V or 0, Figure 1	132			
<b>LVTTTL/LVCMOS OUTPUT (OUT)</b>						
Output High Voltage	V <sub>OH</sub>	I <sub>OH</sub> = -8.0mA Inputs open or undriven short or undriven 100Ω termination V <sub>ID</sub> = +50mV	V <sub>CC</sub> - 0.3			V
			V <sub>CC</sub> - 0.3			
Output Low Voltage	V <sub>OL</sub>	I <sub>OL</sub> = +8.0mA, V <sub>ID</sub> = -50mV		0.25		V
Output Short-Circuit Current	I <sub>OS</sub>	V <sub>ID</sub> = +50mV, V <sub>OUT</sub> = 0			-125	mA
<b>SUPPLY CURRENT</b>						
Supply Current	I <sub>CC</sub>	No load, inputs undriven (fail-safe)		150	300	μA
		No load, inputs driven			7	mA

# Single 500Mbps LVDS Line Receiver in SC70

MAX9130

## AC ELECTRICAL CHARACTERISTICS

( $V_{CC} = +3.0V$  to  $+3.6V$ ,  $C_L = 15pF$ , differential input voltage  $|V_{ID}| = 0.15V$  to  $1.0V$ , input common voltage  $V_{CM} = |V_{ID}|/2$  to  $2.4V - |V_{ID}|/2$ , input rise and fall time =  $1ns$  (20% to 80%), input frequency =  $250MHz$ ,  $T_A = -40^{\circ}C$  to  $+85^{\circ}C$ , unless otherwise noted. Typical values at  $V_{CC} = +3.3V$ ,  $|V_{ID}| = 0.2V$ ,  $V_{CM} = 1.2V$ ,  $T_A = +25^{\circ}C$ .) (Figures 2 and 3) (Notes 4 and 5)

PARAMETER	SYMBOL	CONDITIONS	MIN	TYP	MAX	UNITS
Differential Propagation Delay High to Low	$t_{PHLD}$		1.2	1.8	3	ns
Differential Propagation Delay Low to High	$t_{PLHD}$		1.2	1.8	3	ns
Differential Pulse Skew $ t_{PHLD} - t_{PLHD} $ (Note 6)	$t_{SKD1}$				250	ps
Differential Part-to-Part Skew (Note 7)	$t_{SKD2}$				1.3	ns
Differential Part-to-Part Skew (Note 8)	$t_{SKD3}$				1.8	ns
Rise Time	$t_{TLH}$			0.5	0.8	ns
Fall Time	$t_{THL}$			0.5	0.8	ns
Maximum Operating Frequency (Note 9)	$f_{MAX}$		250			MHz

**Note 2:** Maximum and minimum limits over temperature are guaranteed by design and characterization. Devices are production tested at  $T_A = +25^{\circ}C$ .

**Note 3:** Current into a pin is defined as positive. Current out of a pin is defined as negative. All voltages are referenced to ground except  $V_{TH}$ ,  $V_{TL}$ , and  $V_{ID}$ .

**Note 4:** AC parameters are guaranteed by design and characterization.

**Note 5:**  $C_L$  includes scope probe and test jig capacitance.

**Note 6:**  $t_{SKD1}$  is the magnitude difference of differential propagation delays.  $t_{SKD1} = |t_{PHLD} - t_{PLHD}|$ .

**Note 7:**  $t_{SKD2}$  is the magnitude difference of any differential propagation delays between parts operating over rated conditions at the same  $V_{CC}$  and within  $5^{\circ}C$  of each other.

**Note 8:**  $t_{SKD3}$  is the magnitude difference of any differential propagation delays between parts operating over rated conditions.

**Note 9:**  $f_{MAX}$  pulse generator output conditions: rise time = fall time =  $1ns$  (0% to 100%), 50% duty cycle,  $V_{OH} = +1.3V$ ,  $V_{OL} = +1.1V$ . MAX9130 output criteria: 60% to 40% duty cycle,  $V_{OL} = 0.25V$  max,  $V_{OH} = 2.7V$  min, load =  $15pF$ .

# Single 500Mbps LVDS Line Receiver in SC70

## Typical Operating Characteristics

( $V_{CC} = +3.3V$ ,  $C_L = 15pF$ ,  $|V_{ID}| = 0.2V$ ,  $V_{CM} = 1.2V$ , input rise and fall time = 1ns (20% to 80%), input frequency = 250MHz, 50% duty cycle,  $T_A = +25^\circ C$ , unless otherwise noted.)

**SUPPLY CURRENT vs. FREQUENCY**

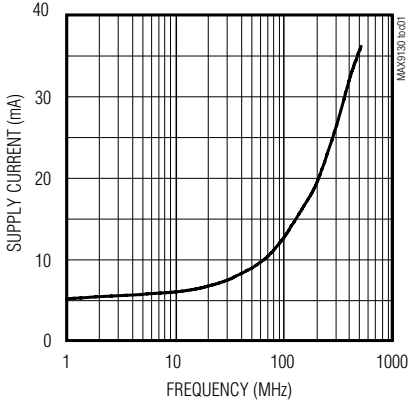

**SUPPLY CURRENT vs. TEMPERATURE**

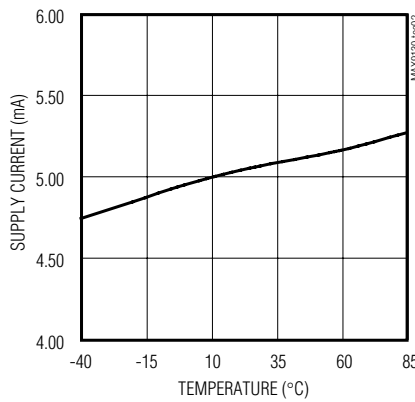

**OUTPUT SHORT-CIRCUIT CURRENT vs. SUPPLY VOLTAGE**

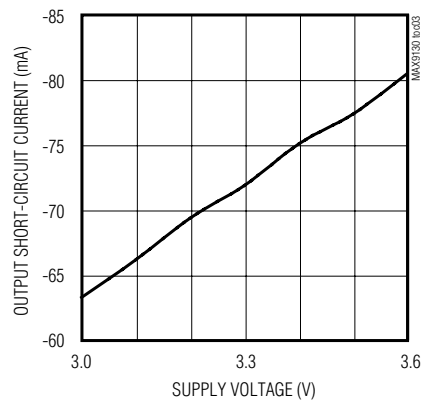

**OUTPUT HIGH VOLTAGE vs. SUPPLY VOLTAGE**

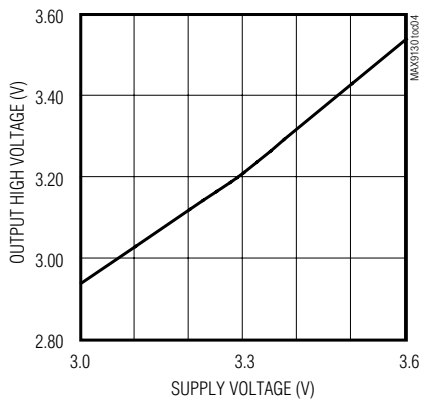

**OUTPUT LOW VOLTAGE vs. SUPPLY VOLTAGE**

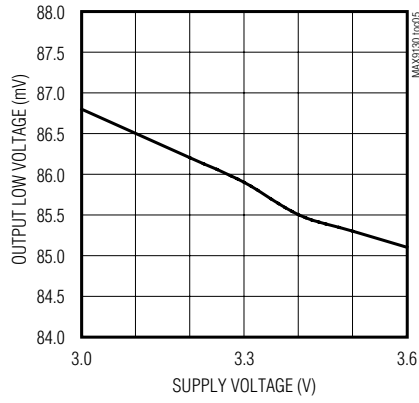

**DIFFERENTIAL PROPAGATION DELAY vs. SUPPLY VOLTAGE**

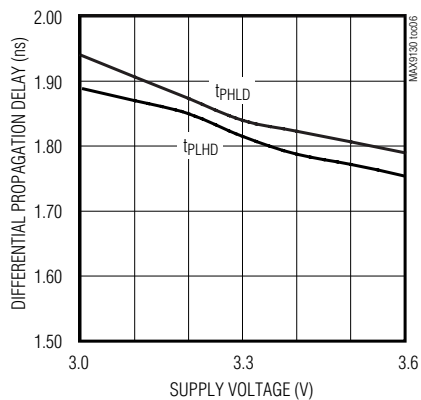

**DIFFERENTIAL PROPAGATION DELAY vs. TEMPERATURE**

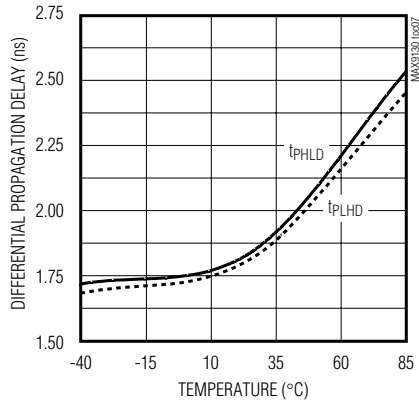

# Single 500Mbps LVDS Line Receiver in SC70

MAX9130

## Typical Operating Characteristics (continued)

( $V_{CC} = +3.3V$ ,  $C_L = 15pF$ ,  $|V_{ID}| = 0.2V$ ,  $V_{CM} = 1.2V$ , input rise and fall time = 1ns (20% to 80%), input frequency = 250MHz, 50% duty cycle,  $T_A = +25^\circ C$ , unless otherwise noted.)

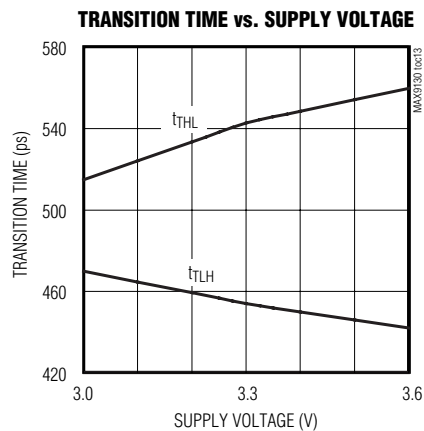
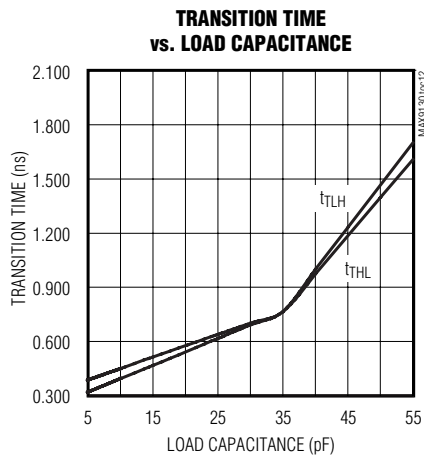
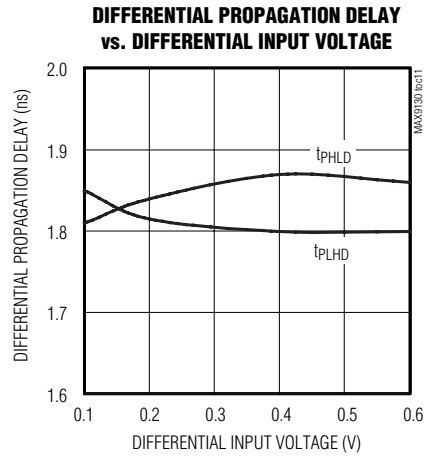
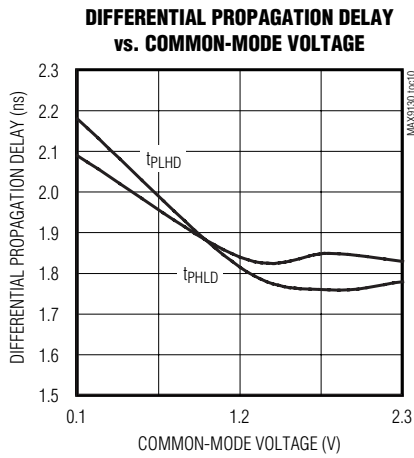
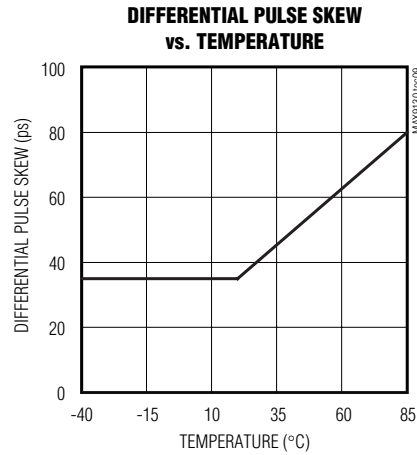
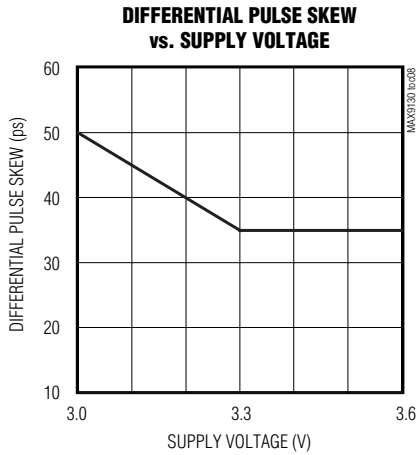

# Single 500Mbps LVDS Line Receiver in SC70

## Pin Description

PIN	NAME	FUNCTION
1	VCC	Power-Supply Input. Bypass VCC to GND with a 0.01 $\mu$ F ceramic capacitor.
2, 5	GND	Ground
3	IN-	Inverting LVDS Differential Input
4	IN+	Noninverting LVDS Differential Input
6	OUT	LVTTL/LVCMOS Output

## Detailed Description

LVDS is intended for point-to-point communication over a controlled-impedance medium as defined by the ANSI TIA/EIA-644 and IEEE 1596.3 standards. LVDS uses a lower voltage swing than other common communication standards, achieving higher data rates with reduced power consumption while reducing EMI emissions and system susceptibility to noise.

The MAX9130 is a single LVDS line receiver ideal for applications requiring high data rates, low power, and low noise. The device accepts an LVDS input and translates it to an LVTTL/LVCMOS output. The receiver detects differential signals as low as 50mV and as high as 1V within an input voltage range of 0 to +2.4V.

The 250mV to 450mV differential output of an LVDS driver is nominally centered around a +1.25V offset. This offset, coupled with the receiver's 0 to +2.4V input voltage range, allows an approximate  $\pm 1$ V shift in the signal (as seen by the receiver). This allows for a difference in ground references of the driver and the receiver, the common-mode effects of coupled noise, or both. The LVDS standards specify an input voltage range of 0 to +2.4V referenced to receiver ground.

### Fail-Safe

The fail-safe feature of the MAX9130 sets the output high and reduces supply current to 150 $\mu$ A when:

- inputs are open
- inputs are undriven and shorted
- inputs are undriven and terminated

A fail-safe circuit is important because under these conditions, noise at the input may switch the receiver and it may appear to the system that data is being received. Open or undriven terminated input conditions can occur when a cable is disconnected or cut, or when an LVDS driver output is in high impedance. A short condition can occur because of a cable failure.

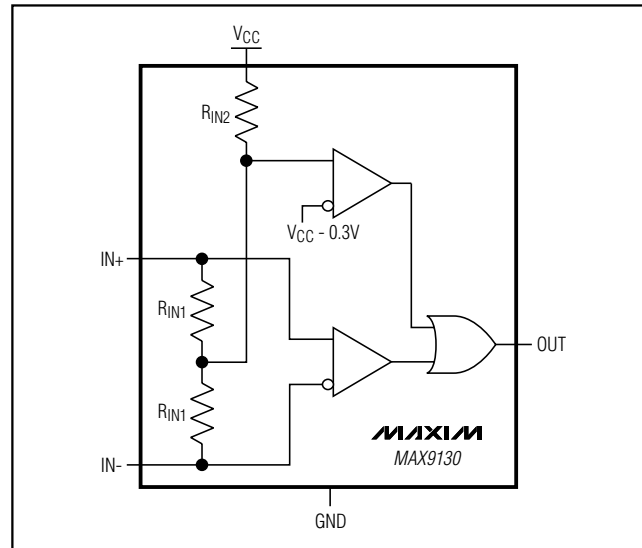

Figure 1. Fail-Safe Input Network

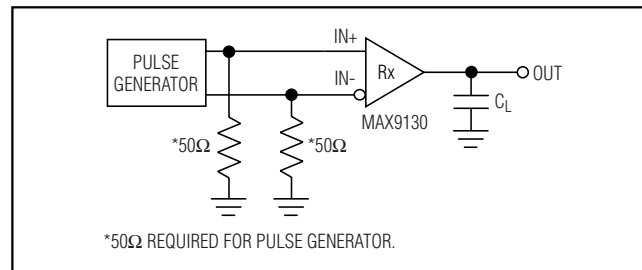

Figure 2. Propagation Delay and Transition Time Test Circuit

The fail-safe input network (Figure 1) samples the input common-mode voltage and compares it to  $V_{CC} - 0.3V$  (nominal). When the input is driven to levels specified in the LVDS standards, the input common-mode voltage is less than  $V_{CC} - 0.3V$  and the fail-safe circuit is not activated. If the inputs are open or if the inputs are undriven and shorted or undriven and parallel terminated, there is no input current. In this case, a pullup resistor in the fail-safe circuit pulls both inputs above  $V_{CC} - 0.3V$ , activating the fail-safe circuit and forcing the output high.

## Applications Information

### Power-Supply Bypassing

Bypass  $V_{CC}$  with a high-frequency surface-mount ceramic 0.01 $\mu$ F capacitor as close to the device as possible.

# Single 500Mbps LVDS Line Receiver in SC70

**MAX9130**

## Differential Traces

Input trace characteristics affect the performance of the MAX9130. Use controlled-impedance PC board traces, typically 100Ω. Match the termination resistor to this characteristic impedance.

Eliminate reflections and ensure that noise couples as common mode by running the differential traces close together. Reduce skew by matching the electrical length of the traces. Excessive skew can result in a degradation of magnetic field cancellation.

Input differential signals should be routed close to each other to cancel their external magnetic field. Maintain a constant distance between the differential traces to avoid discontinuities in differential impedance. Minimize the number of vias to further prevent impedance discontinuities.

## Cables and Connectors

Transmission media should typically have a controlled differential impedance of 100Ω. Use cables and connectors that have matched differential impedance to minimize impedance discontinuities.

Avoid the use of unbalanced cables such as ribbon or simple coaxial cable. Balanced cables such as twisted pair offer superior signal quality and tend to generate less EMI due to canceling effects. Balanced cables tend to pick up noise as common mode, which is rejected by the LVDS receiver.

## Termination

The MAX9130 requires an external termination resistor. The termination resistor should match the differential impedance of the transmission line. Termination resistance is typically 100Ω but may range between 90Ω to 132Ω, depending on the characteristic impedance of the transmission medium.

When using the MAX9130, minimize the distance between the input termination resistor and the MAX9130 receiver inputs. Use 1% surface-mount resistors.

## Board Layout

For LVDS applications, use a four-layer PC board that provides separate layers for power, ground, and input/output signals is recommended. Keep the LVDS input signals away from the output LVCMOS/LVTTL signal to prevent coupling (Figure 4). To minimize crosstalk, do not run the output in parallel with the inputs.

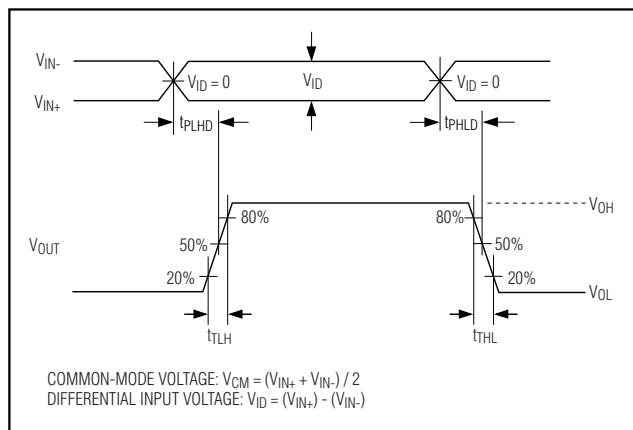

Figure 3. Propagation Delay and Transition Time Waveforms

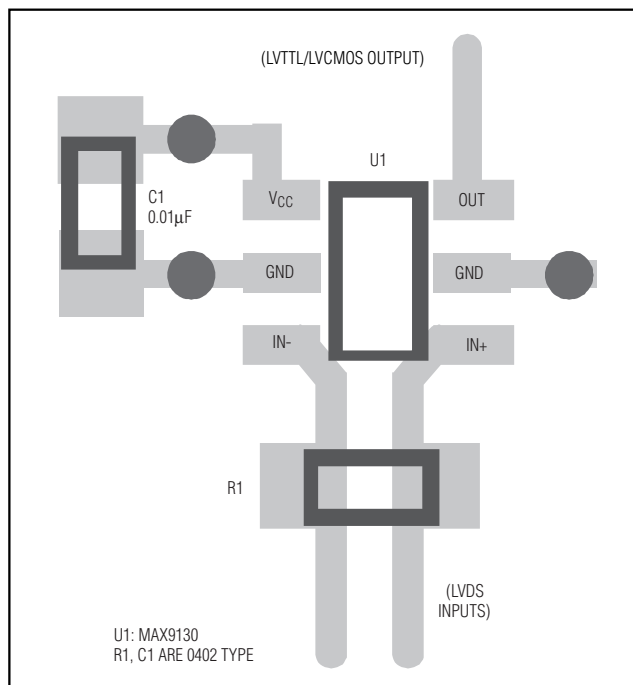

Figure 4. Board Layout

## Chip Information

TRANSISTOR COUNT: 201  
PROCESS: CMOS

# Single 500Mbps LVDS Line Receiver in SC70

## Package Information

PIN 1 DOT (SEE NOTE 6)

PIN 1

Q1

Q1

SYMBOL	MIN	MAX
e	0.65	BSC
D	1.80	2.20
b	0.15	0.30
E	1.15	1.35
HE	1.80	2.40
Q1	0.10	0.40
A2	0.80	1.00
A1	0.00	0.10
A	0.80	1.10
c	0.10	0.18
L	0.10	0.30
L1	0.425	TYP.

1. ALL DIMENSIONS ARE IN MILLIMETERS
2. DIMENSIONS ARE INCLUSIVE OF PLATING
3. DIMENSIONS ARE EXCLUSIVE OF MOLD FLASH & METAL BURR
4. ALL SPECIFICATIONS COMPLY TO EIAJ SC70
5. COPLANARITY 4 MILS. MAX.
6. PIN 1 I.D. DOT

**MAXIM**  
PROPRIETARY INFORMATION  
 TITLE:  
 PACKAGE OUTLINE, SC70, 6L  
 APPROVAL: \_\_\_\_\_ DOCUMENT CONTROL NO. 21-0077 REV B 1/1

SC70, 6LEPS

Maxim cannot assume responsibility for use of any circuitry other than circuitry entirely embodied in a Maxim product. No circuit patent licenses are implied. Maxim reserves the right to change the circuitry and specifications without notice at any time.

8 Maxim Integrated Products, 120 San Gabriel Drive, Sunnyvale, CA 94086 408-737-7600