

**Model 1325, 5230, 5406, 6546**  
**Standard Banana Plug, Solderless and Stackable**

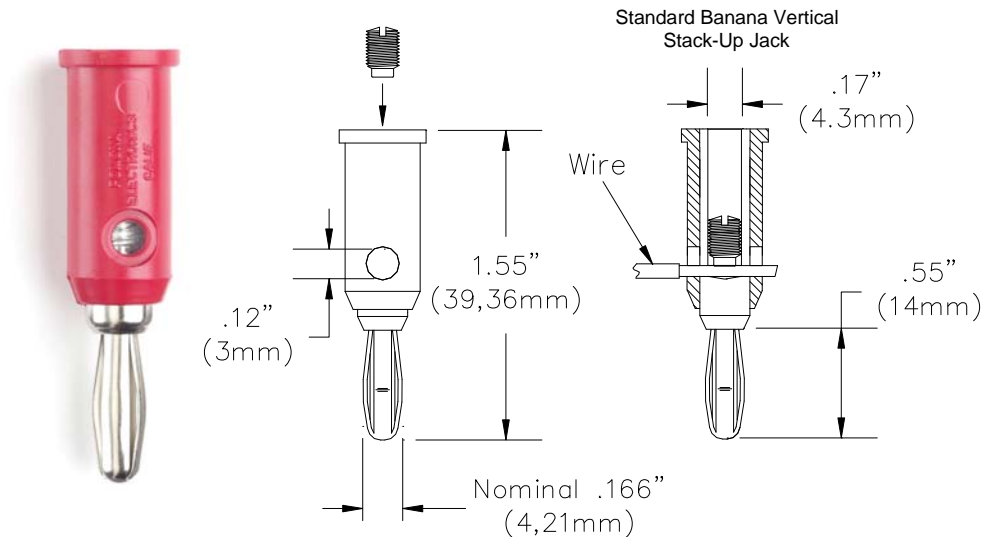

**Features**

- Designed to fit on the end of any 22 AWG to 18 AWG wire.
- Cross hole wire entry fits wires up to .12" (3mm) diameter.
- Available with tarnish resistant nickel or gold plating for very low contact resistance.
- Model 5230 is rated to temperatures up to +302°F (+150°C).
- Set screw simplifies assembly of test leads and jumpers by using a flat blade screwdriver.
- Fits standard panel and binding post banana jacks .161" to .166" (4,0mm to 4,2mm) diameter.



**Materials**

- Banana Jack: Beryllium Copper, Gold Plated  
 Banana Plug: *Body* – Brass, Nickel Plated (Model 5406 is Gold Plated)  
*Spring* – Beryllium Copper, Nickel Plated (Model 5406 Gold Plated)  
 Insulation: Polypropylene (Model 5230 is Polyphenylene Sulfide)  
 Set Screw: Steel, Zinc Plated, 8-32 Single Slot

**Ratings**

- Voltage: For *CE compliance* and for personal safety, do not hold in hand when voltages exceed 33 Vrms/70 Vdc. Maximum voltage for *hands free use* in controlled testing environments: 5000 Vrms Max. Do not use on circuits where transient stresses can exceed the rated voltage.
- Current: 15 Amps
- Maximum Operating Temperature: +122°F (+50°C) max. (Model 5230: +302°F (+150°C) max.)

**Ordering Information**

- Model: 1325-**color** Nickel Plated Banana with Polypropylene Insulation  
**Color:** 0=Black, 1=Brown, 2=Red, 3=Orange, 4=Yellow, 5=Green, 6=Blue, 7=Violet, 8=Gray, 9=White, 02=set of Black and Red  
 Ordering example: 1325-5 (1325 with Green Polypropylene Insulation)

- Model: 5406-0 Gold Plated Banana Plug with Polypropylene Black Insulation  
 Model: 5406-2 Gold Plated Banana Plug with Polypropylene Red Insulation  
 Model: 5230-0 Nickel Plated Banana with High Temperature Black Insulation (Polyphenylene Sulfide)  
 Model: 5230-6 Nickel Plated Banana with High Temperature Blue Insulation (Polyphenylene Sulfide)  
 Model: 6546 Package of ten 1325, one of each color.  
 Model: 4914 Replacement Set Screws, package of 100.

**USA:** Sales: 800-490-2361  
 Technical Support: [technicalsupport@pomonatest.com](mailto:technicalsupport@pomonatest.com)  
 Fax: 425-446-5844

**Europe:** 31-(0) 40 2675 150 **International:** 425-446-5500  
**Where to Buy:** [www.pomonaelectronics.com](http://www.pomonaelectronics.com)

All dimensions are in inches. Tolerances (except noted): .xx = ±.02" (.51 mm), .xxx = ±.005" (.127 mm). All specifications are to the latest revisions. Specifications are subject to change without notice. Registered trademarks are the property of their respective companies.