

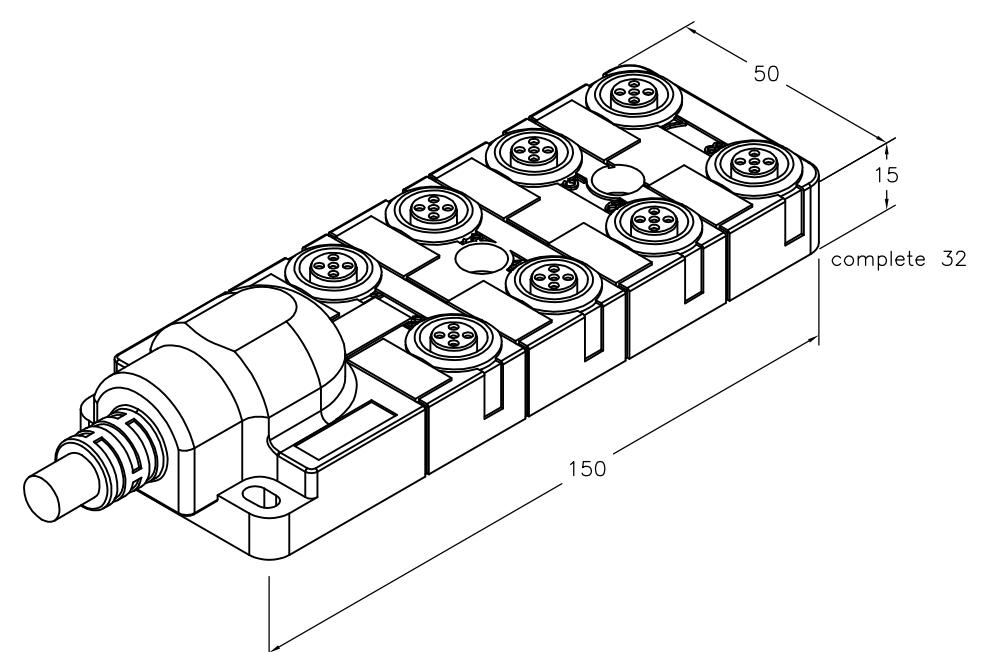

THIS DRAWING IS UNPUBLISHED. RELEASED FOR PUBLICATION
 © COPYRIGHT - By - ALL RIGHTS RESERVED.

LOC	DIST	REVISIONS			
P	LTR	DESCRIPTION	DATE	DWN	APVD
	A	INITIAL RELEASE	16JAN2014	GSK	BvH

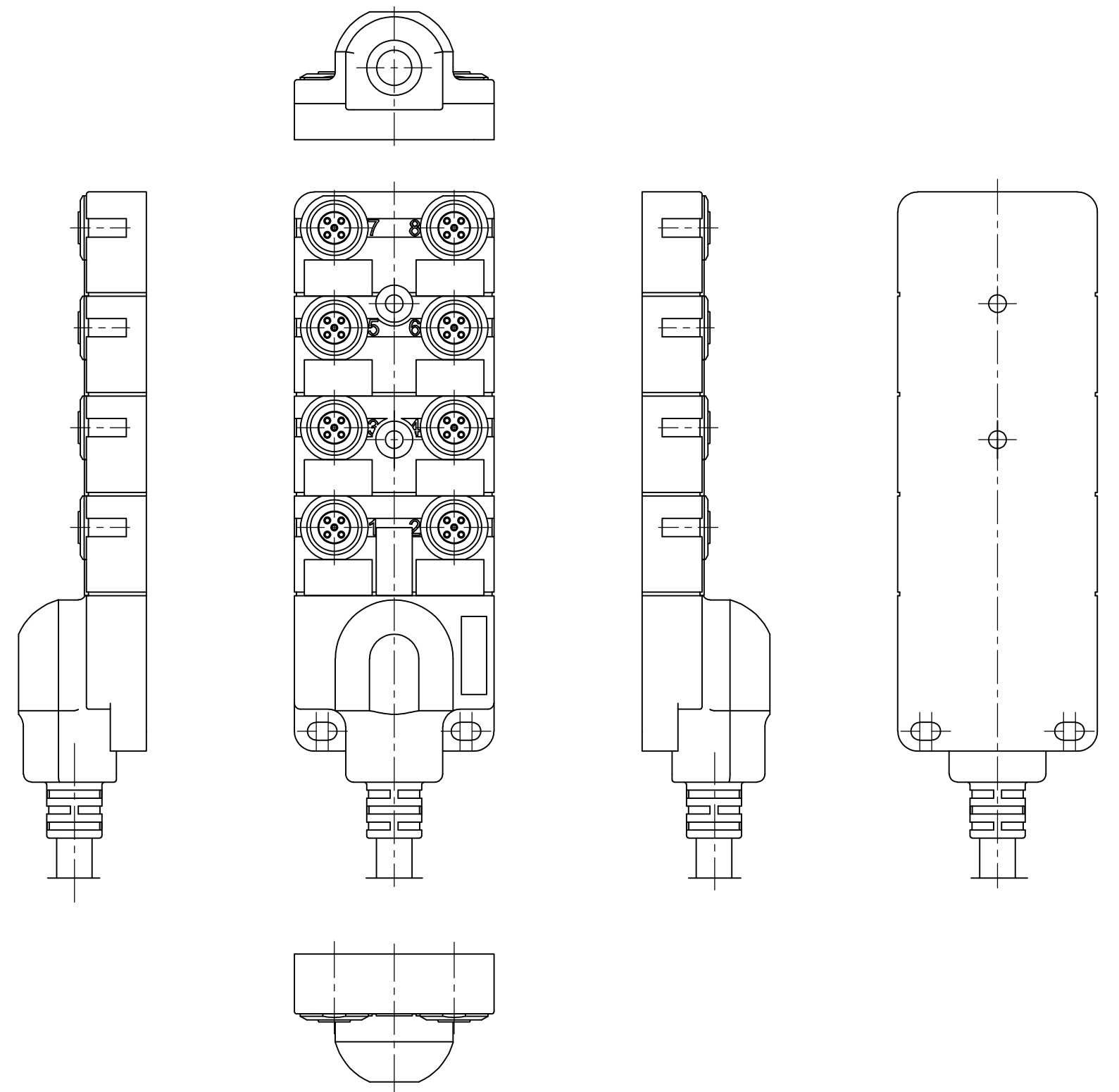

PUR cable 20m	1-2273163-5
PUR cable 15m	1-2273163-4
PUR cable 10m	1-2273163-3
PUR cable 5m	1-2273163-2
PUR cable 3m	1-2273163-1
PUR/PVC cable 20m	2273163-5
PUR/PVC cable 15m	2273163-4
PUR/PVC cable 10m	2273163-3
PUR/PVC cable 5m	2273163-2
PUR/PVC cable 3m	2273163-1
DESCRIPTION	TE PN

THIS DRAWING IS A CONTROLLED DOCUMENT.		DWN 16JAN2014 SATHISH KUMAR .G	 TE Connectivity	
DIMENSIONS: mm		CHK 16JAN2014 B.VELDHOVEN		
TOLERANCES UNLESS OTHERWISE SPECIFIED:		APVD 16JAN2014 A.VAN ZANDVOORT	NAME DISTR BOX M12 5POS 8WAY PNP	
0 PLC ± - 1 PLC ± - 2 PLC ± - 3 PLC ± - 4 PLC ± - ANGLES ± -		PRODUCT SPEC -	-	
MATERIAL		APPLICATION SPEC -	-	
FINISH		WEIGHT -	SIZE A3	CAGE CODE 00779
		DRAWING NO C-2273163		RESTRICTED TO -
		CUSTOMER DRAWING		SCALE NTS
		SHEET 1 OF 2		REV A

THIS DRAWING IS UNPUBLISHED. RELEASED FOR PUBLICATION
 © COPYRIGHT - By - ALL RIGHTS RESERVED.

LOC	DIST	REVISIONS					
H	-	P	LTR	DESCRIPTION	DATE	DWN	APVD
		-		SEE SHEET 1	-	-	-

Contact layout

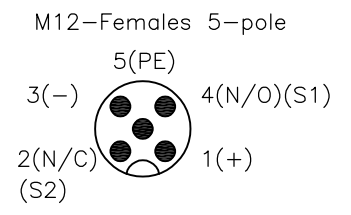

Circuit diagram

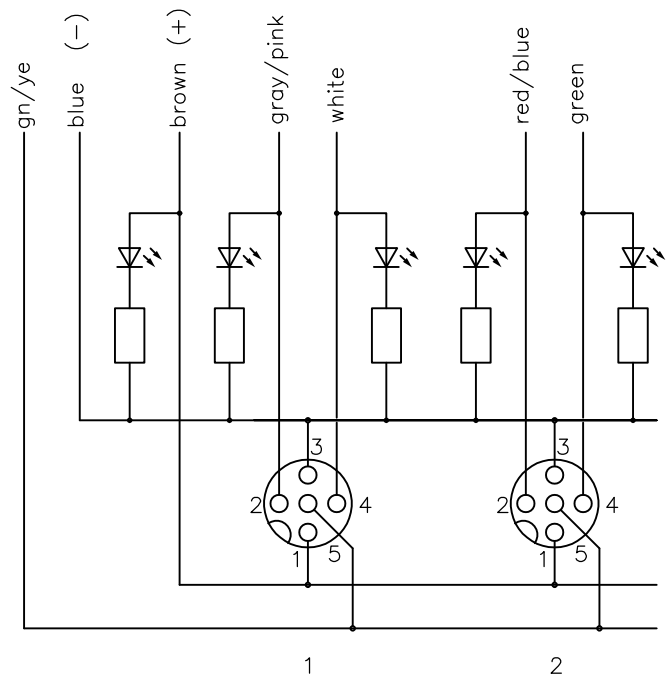

for 2 Signals per port

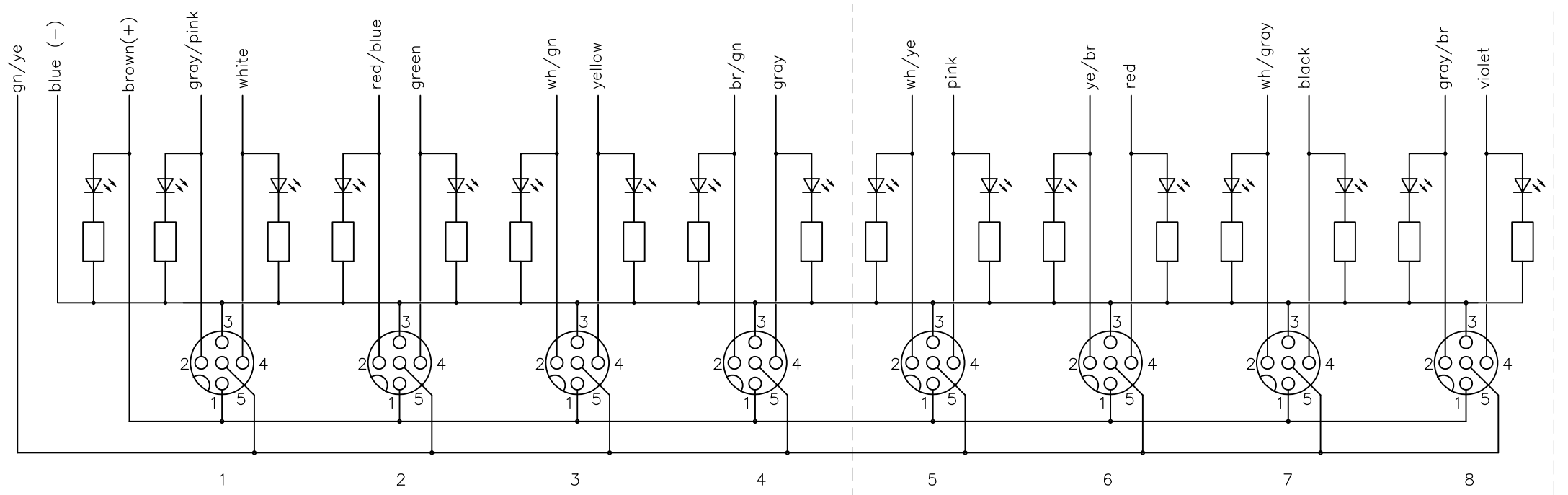

4xM12

8xM12

THIS DRAWING IS A CONTROLLED DOCUMENT.		DWN 16JAN2014 SATHISH KUMAR .G	 TE Connectivity	
DIMENSIONS: mm		CHK 16JAN2014 B.VELDHOVEN		
TOLERANCES UNLESS OTHERWISE SPECIFIED:		APVD 16JAN2014 A.VAN ZANDVOORT	DISTR BOX M12 5POS 8WAY PNP	
0 PLC ± - 1 PLC ± - 2 PLC ± - 3 PLC ± - 4 PLC ± - ANGLES ± -		PRODUCT SPEC	-	
MATERIAL		APPLICATION SPEC	-	
FINISH		WEIGHT	SIZE	RESTRICTED TO
-		-	A3	-
		CUSTOMER DRAWING	CAGE CODE	DRAWING NO
			00779	G-2273163
			SCALE	SHEET
			NTS	2 OF 2
			REV	A