

# RF Power LDMOS Transistors

## High Ruggedness N-Channel Enhancement-Mode Lateral MOSFETs

These 1300 W RF power transistors are designed for applications operating at frequencies between 1020 and 1100 MHz. These devices are suitable for use in defense and commercial pulse applications, such as IFF and secondary surveillance radars.

**Typical Performance:** In 1030, 1090 MHz reference circuit,  $V_{DD} = 50$  Vdc,  $I_{DQ(A+B)} = 100$  mA

Frequency (MHz)	Signal Type	$P_{out}$ (W)	$G_{ps}$ (dB)	$\eta_D$ (%)
1030 (1)	Pulse (128 $\mu$ sec, 10% Duty Cycle)	1300 Peak	18.9	56.0
1090 (1)		1100 Peak	18.8	57.9

**Typical Narrowband Performance:**  $V_{DD} = 50$  Vdc,  $I_{DQ(A+B)} = 100$  mA

Frequency (MHz)	Signal Type	$P_{out}$ (W)	$G_{ps}$ (dB)	$\eta_D$ (%)
1030 (2)	Pulse (128 $\mu$ sec, 10% Duty Cycle)	1300 Peak	18.2	58.1

### Load Mismatch/Ruggedness

Frequency (MHz)	Signal Type	VSWR	$P_{in}$ (W)	Test Voltage	Result
1030 (2)	Pulse (128 $\mu$ sec, 10% Duty Cycle)	> 10:1 at all Phase Angles	40 (3 dB Overdrive)	50	No Device Degradation

1. Measured in 1030, 1090 MHz reference circuit.
2. Measured in 1030 MHz narrowband test circuit.

### Features

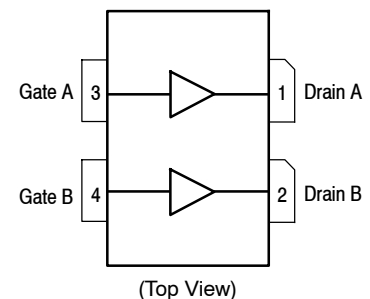
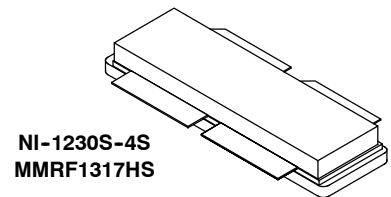
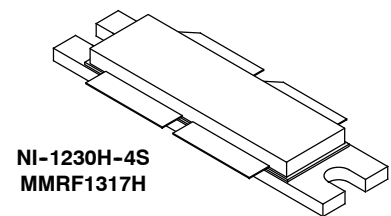
- Internally input and output matched for broadband operation and ease of use
- Device can be used single-ended, push-pull, or in a quadrature configuration
- High ruggedness, handles > 10:1 VSWR
- Integrated ESD protection with greater negative voltage range for improved Class C operation and gate voltage pulsing
- Characterized with series equivalent large-signal impedance parameters

### Applications

- Ground-based secondary surveillance radars
- IFF transponders

## MMRF1317H MMRF1317HS

1030–1090 MHz, 1300 W PEAK, 50 V  
RF POWER LDMOS TRANSISTORS



Note: The backside of the package is the source terminal for the transistor.

**Figure 1. Pin Connections**

**Table 1. Maximum Ratings**

Rating	Symbol	Value	Unit
Drain-Source Voltage	$V_{DSS}$	-0.5, +105	Vdc
Gate-Source Voltage	$V_{GS}$	-6.0, +10	Vdc
Storage Temperature Range	$T_{stg}$	-65 to +150	°C
Case Operating Temperature Range	$T_C$	-55 to +150	°C
Operating Junction Temperature Range (1)	$T_J$	-55 to +225	°C
Total Device Dissipation @ $T_C = 25^\circ\text{C}$ Derate above 25°C	$P_D$	869 4.35	W W/°C

**Table 2. Thermal Characteristics**

Characteristic	Symbol	Value (2)	Unit
Thermal Impedance, Junction to Case Pulse: Case Temperature 70°C, 1300 W Peak, 128 $\mu\text{sec}$ Pulse Width, 10% Duty Cycle, 50 Vdc, $I_{DQ(A+B)} = 100\text{ mA}$ , 1030 MHz	$Z_{\theta JC}$	0.019	°C/W

**Table 3. ESD Protection Characteristics**

Test Methodology	Class
Human Body Model (per JESD22-A114)	2, passes 2500 V
Machine Model (per EIA/JESD22-A115)	B, passes 250 V
Charge Device Model (per JESD22-C101)	IV, passes 2000 V

**Table 4. Electrical Characteristics** ( $T_A = 25^\circ\text{C}$  unless otherwise noted)

Characteristic	Symbol	Min	Typ	Max	Unit
----------------	--------	-----	-----	-----	------

**Off Characteristics (3)**

Gate-Source Leakage Current ( $V_{GS} = 5\text{ Vdc}$ , $V_{DS} = 0\text{ Vdc}$ )	$I_{GSS}$	—	—	1	$\mu\text{A}$ dc
Drain-Source Breakdown Voltage ( $V_{GS} = 0\text{ Vdc}$ , $I_D = 10\ \mu\text{A}$ dc)	$V_{(BR)DSS}$	105	—	—	Vdc
Zero Gate Voltage Drain Leakage Current ( $V_{DS} = 50\text{ Vdc}$ , $V_{GS} = 0\text{ Vdc}$ )	$I_{DSS}$	—	—	1	$\mu\text{A}$ dc
Zero Gate Voltage Drain Leakage Current ( $V_{DS} = 105\text{ Vdc}$ , $V_{GS} = 0\text{ Vdc}$ )	$I_{DSS}$	—	—	10	$\mu\text{A}$ dc

**On Characteristics**

Gate Threshold Voltage (3) ( $V_{DS} = 10\text{ Vdc}$ , $I_D = 520\ \mu\text{A}$ dc)	$V_{GS(th)}$	1.3	1.7	2.3	Vdc
Gate Quiescent Voltage (4) ( $V_{DD} = 50\text{ Vdc}$ , $I_{D(A+B)} = 100\text{ mA}$ dc, Measured in Functional Test)	$V_{GS(Q)}$	1.5	2.0	2.5	Vdc
Drain-Source On-Voltage (3) ( $V_{GS} = 10\text{ Vdc}$ , $I_D = 2.6\text{ A}$ dc)	$V_{DS(on)}$	0.1	0.3	0.5	Vdc

**Dynamic Characteristics (3)**

Reverse Transfer Capacitance ( $V_{DS} = 50\text{ Vdc} \pm 30\text{ mV(rms)}$ ac @ 1 MHz, $V_{GS} = 0\text{ Vdc}$ )	$C_{rss}$	—	2.43	—	pF
--	-----------	---	------	---	----

1. Continuous use at maximum temperature will affect MTF.
2. Refer to AN1955, *Thermal Measurement Methodology of RF Power Amplifiers*. Go to <http://www.nxp.com/RF> and search for AN1955.
3. Each side of device measured separately.
4. Measurement made with device in push-pull configuration.

(continued)

**Table 4. Electrical Characteristics** ( $T_A = 25^\circ\text{C}$  unless otherwise noted) (continued)

Characteristic	Symbol	Min	Typ	Max	Unit
<b>Functional Tests</b> <sup>(1)</sup> (In Freescale Test Fixture, 50 ohm system) $V_{DD} = 50\text{ Vdc}$ , $I_{DQ(A+B)} = 100\text{ mA}$ , $P_{out} = 1300\text{ W Peak (130 W Avg.)}$ , $f = 1030\text{ MHz}$ , 128 $\mu\text{sec}$ Pulse Width, 10% Duty Cycle					
Power Gain	$G_{ps}$	17.4	18.2	19.1	dB
Drain Efficiency	$\eta_D$	55.0	58.1	—	%
Input Return Loss	IRL	—	-12	-9	dB

**Load Mismatch/Ruggedness** (In Freescale Test Fixture, 50 ohm system)  $I_{DQ(A+B)} = 100\text{ mA}$ 

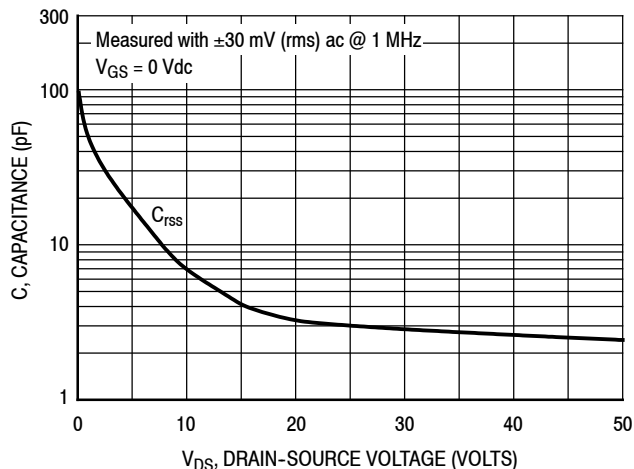
Frequency (MHz)	Signal Type	VSWR	$P_{in}$ (W)	Test Voltage, $V_{DD}$	Result
1030	Pulse (128 $\mu\text{sec}$ , 10% Duty Cycle)	> 10:1 at all Phase Angles	40 (3 dB Overdrive)	50	No Device Degradation

**Table 5. Ordering Information**

Device	Tape and Reel Information	Package
MMRF1317HR5	R5 Suffix = 50 Units, 56 mm Tape Width, 13-inch Reel	NI-1230H-4S, Eared
MMRF1317HSR5		NI-1230S-4S, Earless

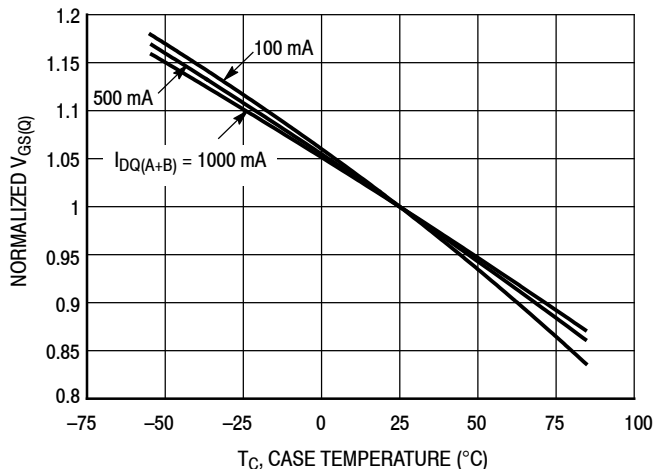
1. Measurement made with device in push-pull configuration.

## TYPICAL CHARACTERISTICS



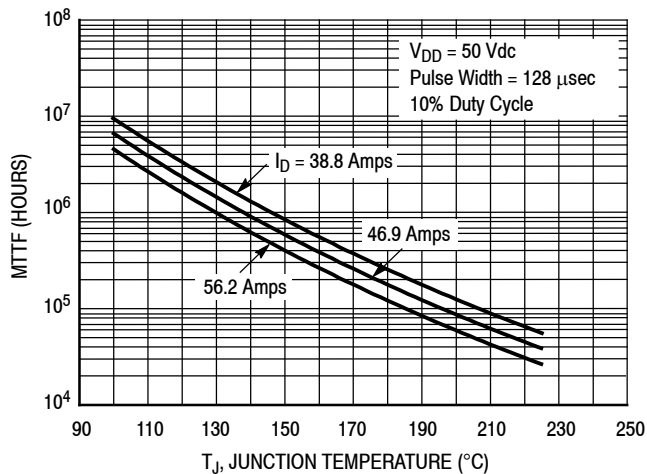
**Note:** Each side of device measured separately.

**Figure 2. Capacitance versus Drain-Source Voltage**



$I_{DQ}$ (mA)	Slope (mV/°C)
100	-2.46
500	-2.21
1000	-2.07

**Figure 3. Normalized  $V_{GS}$  versus Quiescent Current and Case Temperature**



**Note:** MTTF value represents the total cumulative operating time under indicated test conditions.

**Figure 4. MTTF versus Junction Temperature — Pulse**

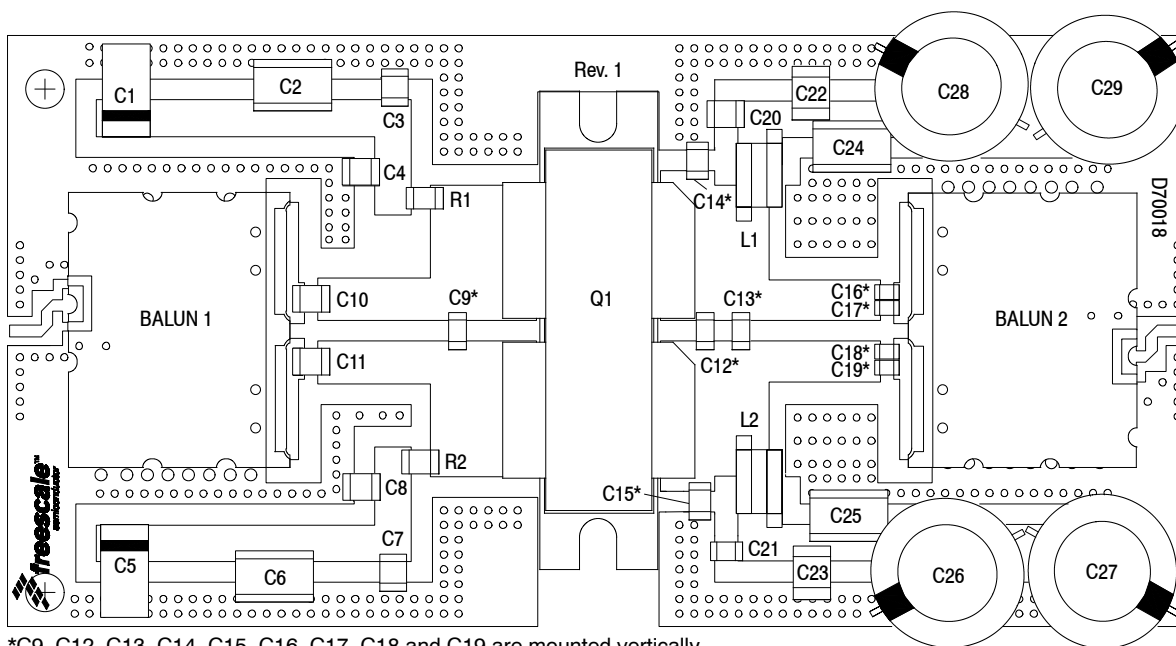
## 1030, 1090 MHz REFERENCE CIRCUIT — 2.0" x 4.0" (5.1 cm x 10.2 cm)

**Table 6. 1030, 1090 MHz Performance** (In Freescale Reference Circuit, 50 ohm system)

$V_{DD} = 50$  Vdc,  $I_{DQ(A+B)} = 100$  mA

Frequency (MHz)	Signal Type	$G_{ps}$ (dB)	$\eta_D$ (%)	$P_{out}$ (W)
1030	Pulse (128 $\mu$ sec, 10% Duty Cycle)	18.9	56.0	1300 Peak
1090		18.8	57.9	1100 Peak

1030, 1090 MHz REFERENCE CIRCUIT — 2.0" x 4.0" (5.1 cm x 10.2 cm)



\*C9, C12, C13, C14, C15, C16, C17, C18 and C19 are mounted vertically.

Figure 5. MMRF1317HR5 Reference Circuit Component Layout — 1030, 1090 MHz

Table 7. MMRF1317H(HS) Reference Circuit Component Designations and Values — 1030, 1090 MHz

Part	Description	Part Number	Manufacturer
Balun 1, 2	800–1000 MHz, 4-to-1 PCB Balun Transformers	3A412S	Anaren
C1, C5	22 $\mu$ F, 35 V Tantalum Capacitors	T491X226K035AT	Kemet
C2, C6	2.2 $\mu$ F Chip Capacitors	C1825C225J5RACTU	Kemet
C3, C7	0.22 $\mu$ F Chip Capacitors	C1210C224K1RACTU	Kemet
C4, C8, C10, C11, C16, C17, C18, C19, C20, C21	36 pF Chip Capacitors	ATC100B360JT500XT	ATC
C9	5.1 pF Chip Capacitor	ATC800B5R1BT500XT	ATC
C12	6.2 pF Chip Capacitor	ATC800B6R2BT500XT	ATC
C13	1.6 pF Chip Capacitor	ATC800B1R5BT500XT	ATC
C14, C15	6.8 pF Chip Capacitors	ATC800B6R8BT500XT	ATC
C22, C23	0.47 $\mu$ F Chip Capacitors	HMK432B7474KM-T	Taiyo Yuden
C24, C25	0.022 $\mu$ F Chip Capacitors	C1825C223K1GACTU	Kemet
C26, C27, C28, C29	470 $\mu$ F, 63 V Electrolytic Capacitors	MCGPR63V477M13X26-RH	Multicom
L1, L2	27.4 nH, 3 Turn, #20 AWG ID = 0.125" Inductors, Hand Wound	8050	Belden
Q1	RF Power LDMOS Transistor	MMRF1317HR5	Freescale
R1, R2	1 k $\Omega$ , 1/4 W Chip Resistors	CRCW12061K00FKEA	Vishay
PCB	Rogers RO3010 0.050", $\epsilon_r = 11.2$	D70018	MTL

TYPICAL CHARACTERISTICS — 1030, 1090 MHz  
REFERENCE CIRCUIT

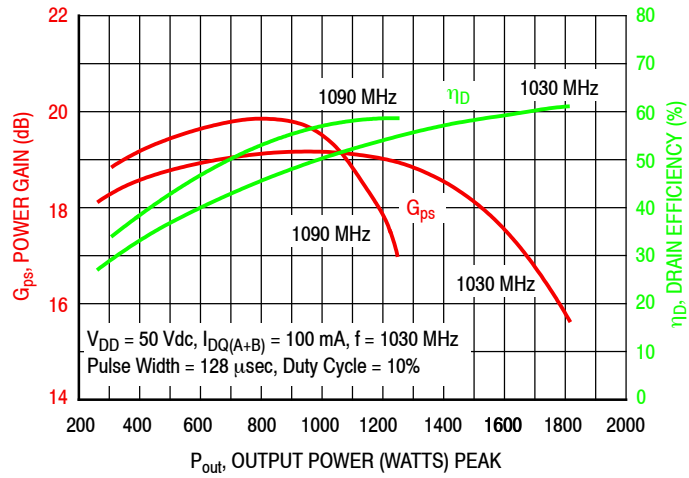
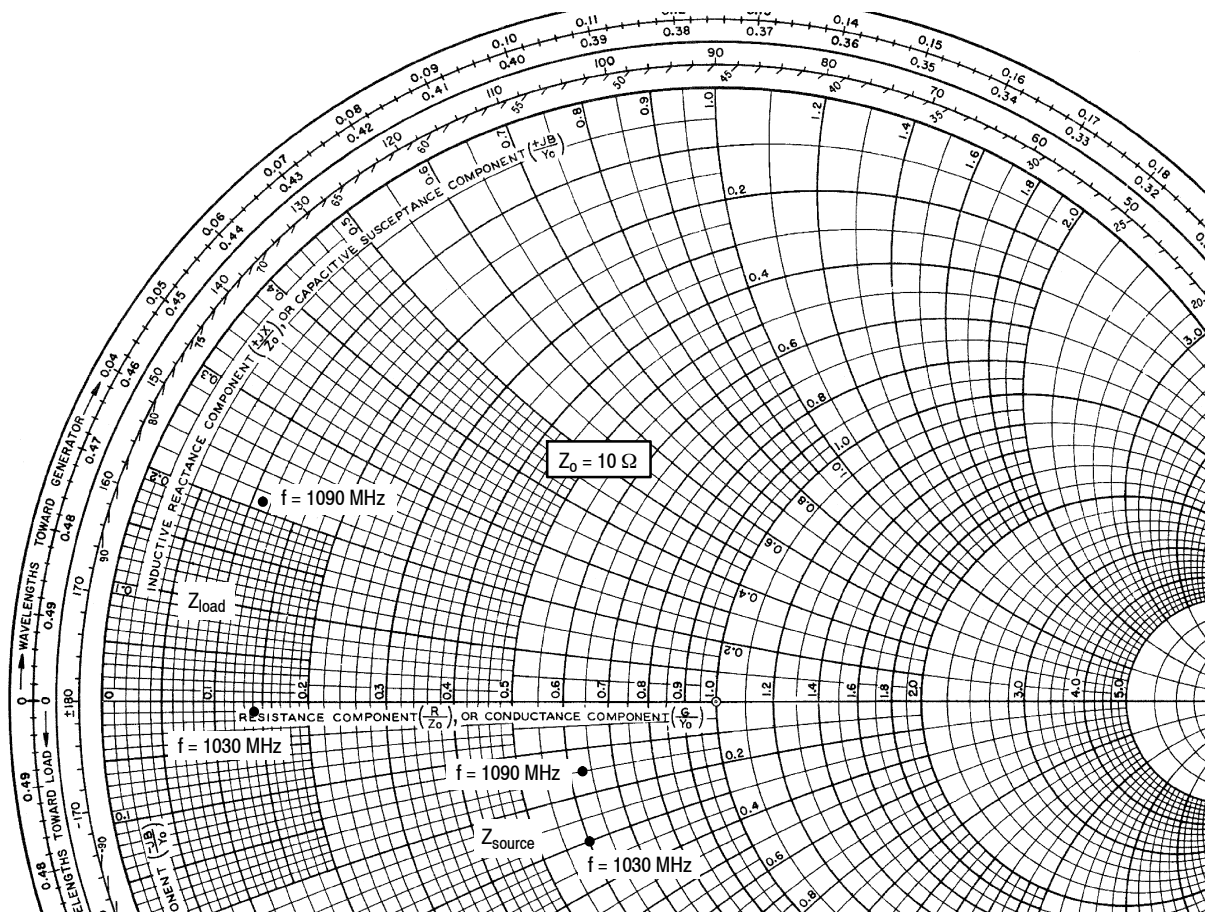


Figure 6. Power Gain and Drain Efficiency versus Output Power

# 1030, 1090 MHz REFERENCE CIRCUIT



f MHz	Z <sub>source</sub> Ω	Z <sub>load</sub> Ω
1030	6.03 - j2.97	1.41 - j0.13
1090	6.30 - j1.54	1.08 + j2.08

Z<sub>source</sub> = Test circuit impedance as measured from gate to gate, balanced configuration.

Z<sub>load</sub> = Test circuit impedance as measured from drain to drain, balanced configuration.

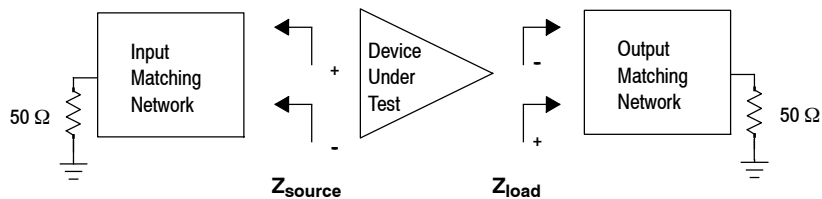


Figure 7. Series Equivalent Source and Load Impedance — 1030, 1090 MHz



1030 MHz NARROWBAND PRODUCTION TEST FIXTURE — 6.0" x 4.0" (15.2 cm x 10.2 cm)

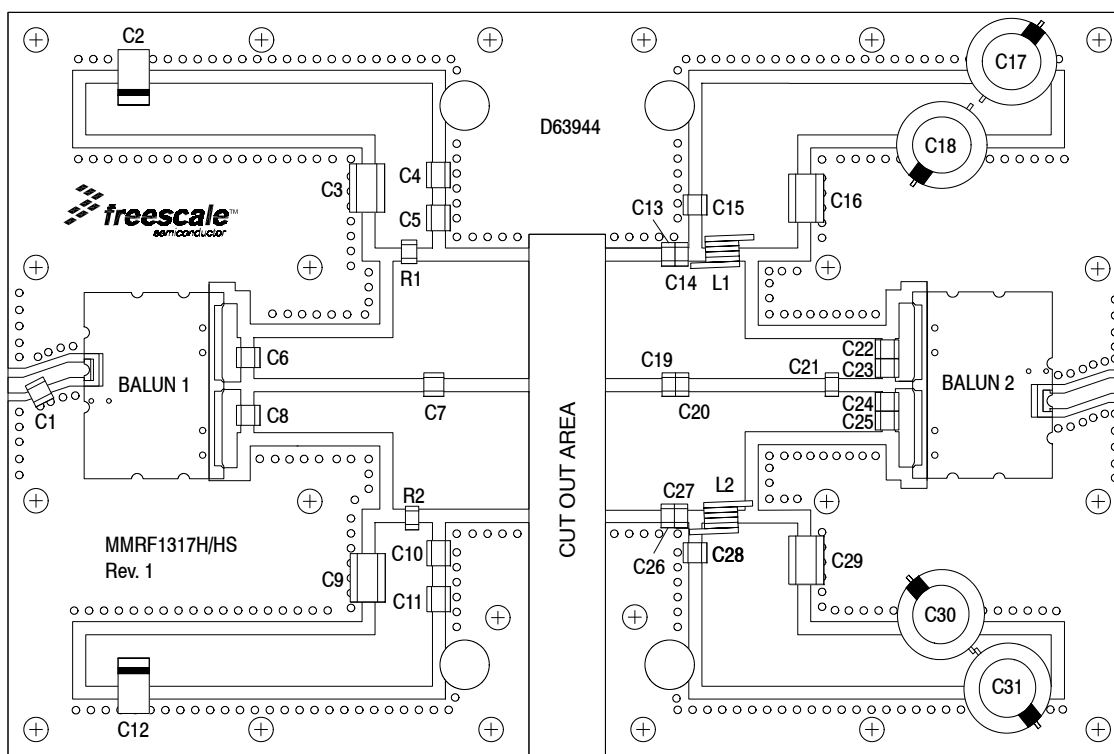
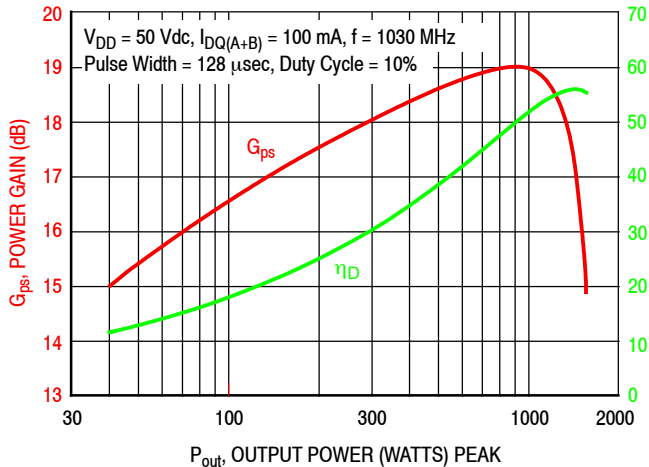


Figure 8. MMRF1317H(HS) Narrowband Test Circuit Component Layout — 1030 MHz

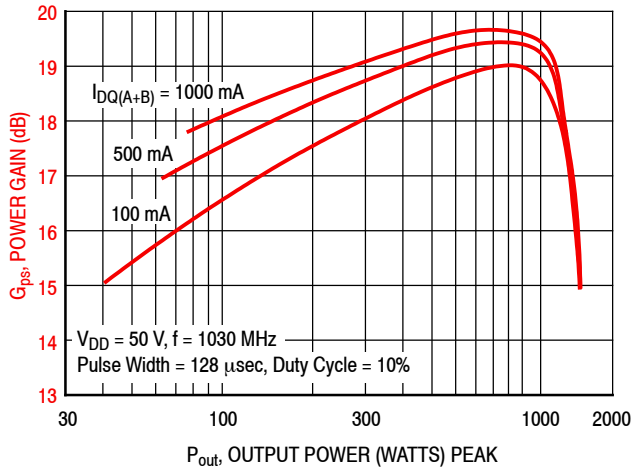
Table 8. MMRF1317H(HS) Narrowband Test Circuit Component Designations and Values — 1030 MHz

Part	Description	Part Number	Manufacturer
Balun 1, 2	800–1000 MHz, 4-to-1 PCB Balun Transformers	3A412S	Anaren
C1	1.0 pF Chip Capacitor	ATC100B1R0JT500XT	ATC
C2, C12	22 $\mu$ F Tantalum Capacitors	T491X226K035AT	Kemet
C3, C9	2.2 $\mu$ F Chip Capacitors	C1825C225J5RACTU	Kemet
C4, C11	0.1 $\mu$ F Chip Capacitors	CDR33BX104AKWS	AVX
C5, C6, C8, C10, C15, C22, C23, C24, C25, C28	36 pF Chip Capacitors	ATC100B360JT500XT	ATC
C7	6.2 pF Chip Capacitor	ATC100B6R2JT500XT	ATC
C13, C19, C26	5.1 pF Chip Capacitors	ATC100B5R1JT500XT	ATC
C14, C27	2.0 pF Chip Capacitors	ATC800B2R0BT500XT	ATC
C16, C29	0.22 $\mu$ F Chip Capacitors	C1825C224K1RACTU	Kemet
C17, C18, C30, C31	470 $\mu$ F, 63 V Electrolytic Capacitors	MCGPR63V477M13X26-RH	Multicomp
C20	3.0 pF Chip Capacitor	ATC100B3R0JT500XT	ATC
C21	2.2 pF Chip Capacitor	ATC100B2R2JT500XT	ATC
L1, L2	12 nH Inductors	GA3094ALB	Coilcraft
R1, R2	100 $\Omega$ , 1/2 W Chip Resistors	CRCW2010100RFKFA	Vishay
PCB	Arlon AD255A, 0.030", $\epsilon_r = 2.55$	D63944	MTL

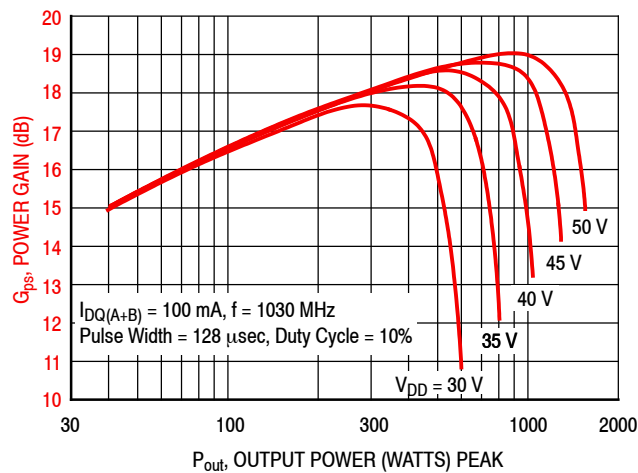
## TYPICAL CHARACTERISTICS — 1030 MHz PRODUCTION TEST FIXTURE



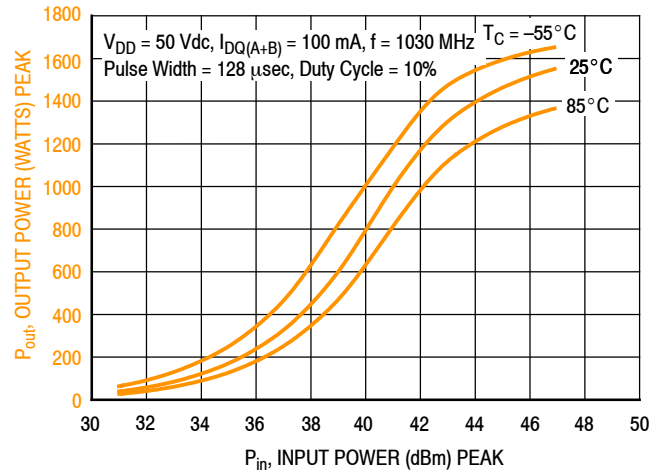
**Figure 9. Power Gain and Drain Efficiency versus Output Power**



**Figure 10. Power Gain versus Output Power and Quiescent Drain Current**

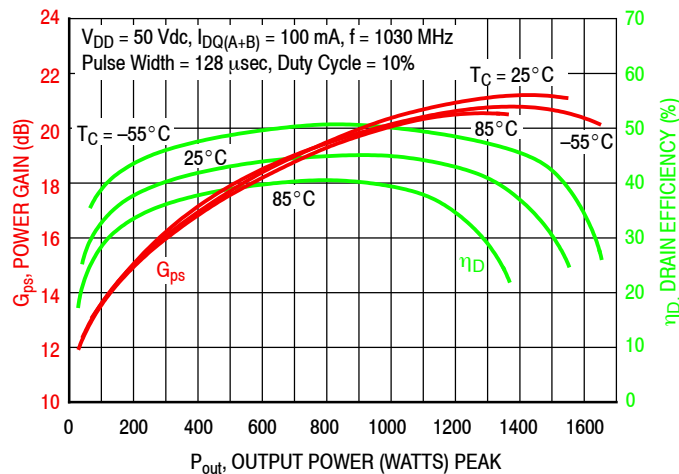


**Figure 11. Power Gain versus Output Power and Drain Voltage**



f (MHz)	P1dB (W)	P3dB (W)
1030	1322	1498

**Figure 12. Output Power versus Input Power**



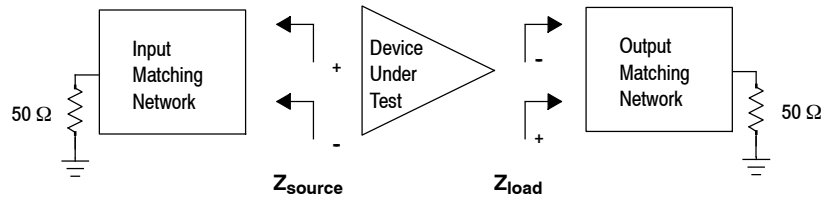
**Figure 13. Power Gain and Drain Efficiency versus Output Power**

## 1030 MHz NARROWBAND PRODUCTION TEST FIXTURE

f MHz	$Z_{\text{source}}$ $\Omega$	$Z_{\text{load}}$ $\Omega$
1030	$3.74 - j1.63$	$2.29 - j0.19$

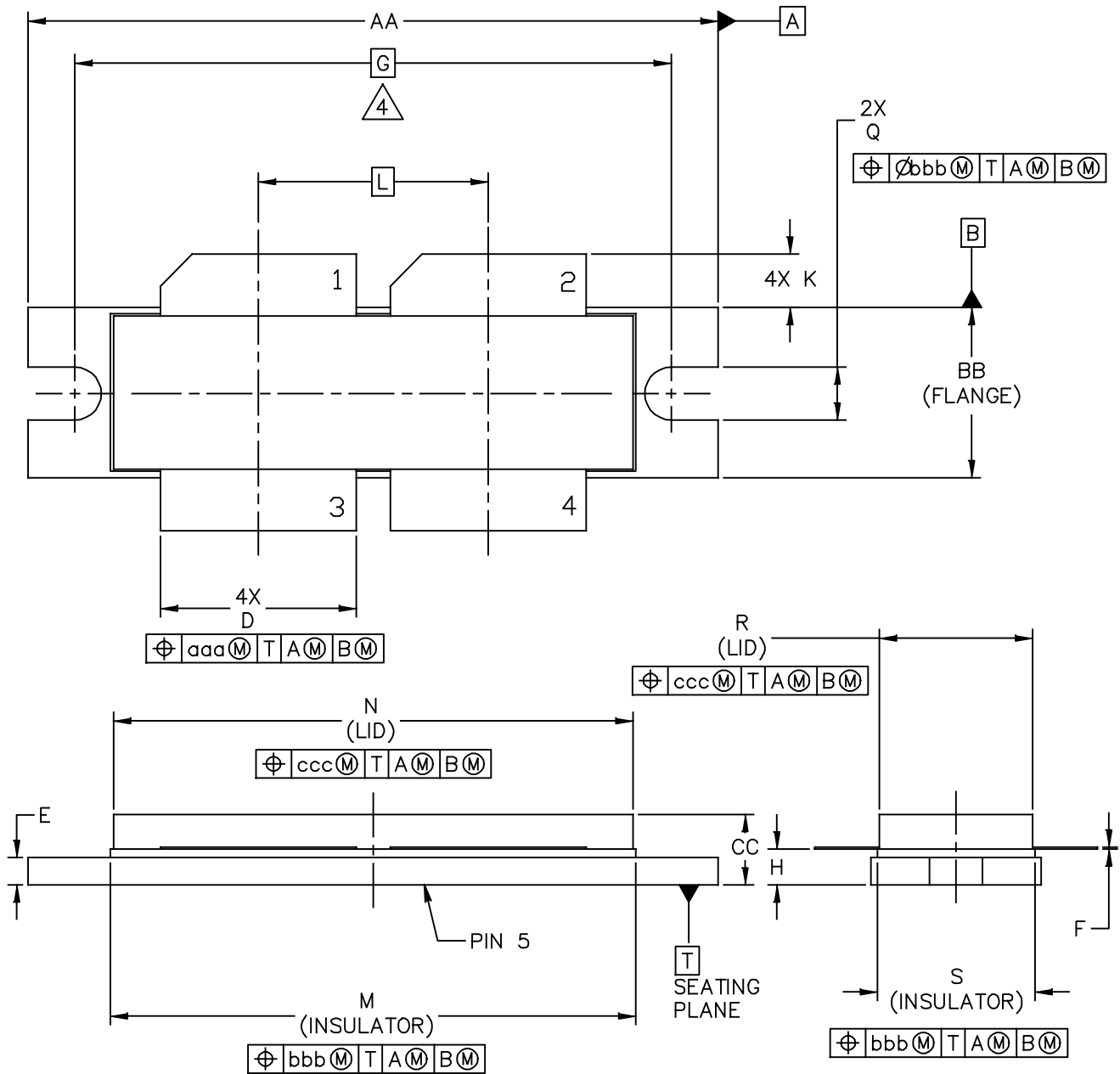
$Z_{\text{source}}$  = Test circuit impedance as measured from gate to gate, balanced configuration.

$Z_{\text{load}}$  = Test circuit impedance as measured from drain to drain, balanced configuration.



**Figure 14. Series Equivalent Source and Load Impedance — 1030 MHz**

### PACKAGE DIMENSIONS

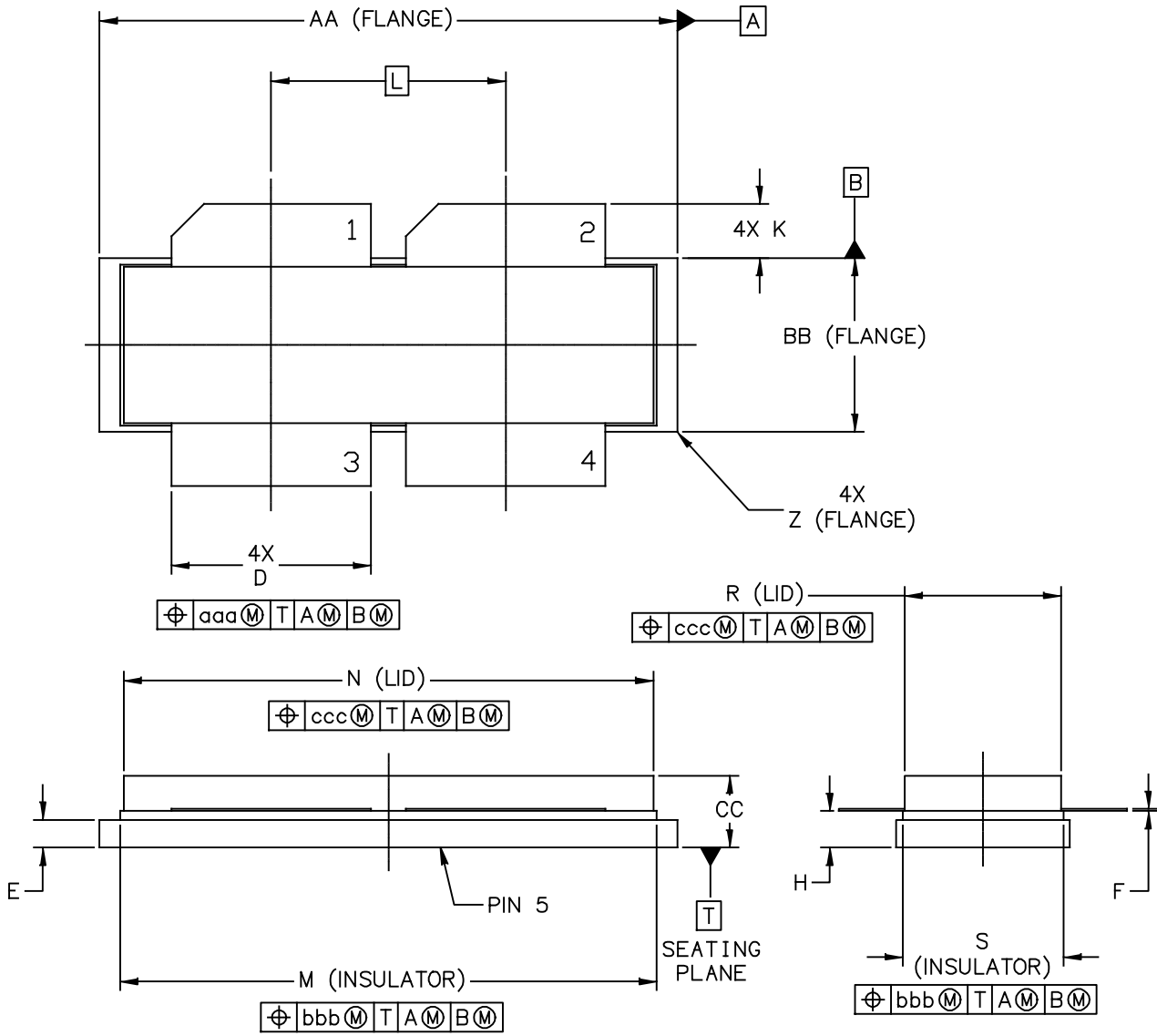


© FREESCALE SEMICONDUCTOR, INC. ALL RIGHTS RESERVED.	MECHANICAL OUTLINE	PRINT VERSION NOT TO SCALE
TITLE:  NI-1230-4H	DOCUMENT NO: 98ASB16977C	REV: F
	STANDARD: NON-JEDEC	
	28 FEB 2013	

NOTES:

1. INTERPRET DIMENSIONS AND TOLERANCES PER ASME Y14.5M-1994.
2. CONTROLLING DIMENSION: INCH
3. DIMENSION H IS MEASURED .030 INCH (0.762 MM) AWAY FROM PACKAGE BODY.
4. RECOMMENDED BOLT CENTER DIMENSION OF 1.52 INCH (38.61 MM) BASED ON M3 SCREW.

DIM	INCH		MILLIMETER		DIM	INCH		MILLIMETER	
	MIN	MAX	MIN	MAX		MIN	MAX	MIN	MAX
AA	1.615	1.625	41.02	41.28	N	1.218	1.242	30.94	31.55
BB	.395	.405	10.03	10.29	Q	.120	.130	3.05	3.30
CC	.170	.190	4.32	4.83	R	.355	.365	9.02	9.27
D	.455	.465	11.56	11.81	S	.365	.375	9.27	9.53
E	.062	.066	1.57	1.68					
F	.004	.007	0.10	0.18					
G	1.400 BSC		35.56 BSC		aaa	.013		0.33	
H	.082	.090	2.08	2.29	bbb	.010		0.25	
K	.117	.137	2.97	3.48	ccc	.020		0.51	
L	.540 BSC		13.72 BSC						
M	1.219	1.241	30.96	31.52					
© FREESCALE SEMICONDUCTOR, INC. ALL RIGHTS RESERVED.			MECHANICAL OUTLINE			PRINT VERSION NOT TO SCALE			
TITLE:					DOCUMENT NO: 98ASB16977C		REV: F		
NI-1230-4H					STANDARD: NON-JEDEC				
					28 FEB 2013				



© NXP SEMICONDUCTORS N. V. ALL RIGHTS RESERVED	MECHANICAL OUTLINE	PRINT VERSION NOT TO SCALE
TITLE:  NI-1230-4S	DOCUMENT NO: 98ARB18247C	REV: H
	STANDARD: NON-JEDEC	
	SOT1829-1	19 FEB 2016

NOTES:

1. INTERPRET DIMENSIONS AND TOLERANCES PER ASME Y14.5M-1994.
2. CONTROLLING DIMENSION: INCH
3. DIMENSION H IS MEASURED .030 INCH (0.762 MM) AWAY FROM PACKAGE BODY

DIM	INCHES		MILLIMETERS		DIM	INCHES		MILLIMETERS	
	MIN	MAX	MIN	MAX		MIN	MAX	MIN	MAX
AA	1.265	1.275	32.13	32.39	R	.355	.365	9.02	9.27
BB	.395	.405	10.03	10.29	S	.365	.375	9.27	9.53
CC	.170	.190	4.32	4.83	Z	R.000	R.040	R0.00	R1.02
D	.455	.465	11.56	11.81					
E	.062	.066	1.57	1.68	aaa	.013		0.33	
F	.004	.007	0.10	0.18	bbb	.010		0.25	
H	.082	.090	2.08	2.29	ccc	.020		0.51	
K	.117	.137	2.97	3.48					
L	.540 BSC		13.72 BSC						
M	1.219	1.241	30.96	31.52					
N	1.218	1.242	30.94	31.55					
© NXP SEMICONDUCTORS N.V. ALL RIGHTS RESERVED			MECHANICAL OUTLINE			PRINT VERSION NOT TO SCALE			
TITLE:  NI-1230-4S					DOCUMENT NO: 98ARB18247C      REV: H				
					STANDARD: NON-JEDEC				
					SOT1829-1			19 FEB 2016	

## PRODUCT DOCUMENTATION

Refer to the following resources to aid your design process.

### Application Notes

- AN1908: Solder Reflow Attach Method for High Power RF Devices in Air Cavity Packages
- AN1955: Thermal Measurement Methodology of RF Power Amplifiers

### To Download Resources Specific to a Given Part Number:

1. Go to <http://www.nxp.com/RF>
2. Search by part number
3. Click part number link
4. Choose the desired resource from the drop down menu

## REVISION HISTORY

The following table summarizes revisions to this document.

Revision	Date	Description
0	Mar. 2016	• Initial Release of Data Sheet



### ***How to Reach Us:***

**Home Page:**  
[freescale.com](http://freescale.com)

**Web Support:**  
[freescale.com/support](http://freescale.com/support)

Information in this document is provided solely to enable system and software implementers to use Freescale products. There are no express or implied copyright licenses granted hereunder to design or fabricate any integrated circuits based on the information in this document.

Freescale reserves the right to make changes without further notice to any products herein. Freescale makes no warranty, representation, or guarantee regarding the suitability of its products for any particular purpose, nor does Freescale assume any liability arising out of the application or use of any product or circuit, and specifically disclaims any and all liability, including without limitation consequential or incidental damages. "Typical" parameters that may be provided in Freescale data sheets and/or specifications can and do vary in different applications, and actual performance may vary over time. All operating parameters, including "typicals," must be validated for each customer application by customer's technical experts. Freescale does not convey any license under its patent rights nor the rights of others. Freescale sells products pursuant to standard terms and conditions of sale, which can be found at the following address: [freescale.com/SalesTermsandConditions](http://freescale.com/SalesTermsandConditions).

Freescale and the Freescale logo are trademarks of Freescale Semiconductor, Inc., Reg. U.S. Pat. & Tm. Off. All other product or service names are the property of their respective owners.

© 2016 Freescale Semiconductor, Inc.

