

### Economical, Compact, Plug-in Timer

- Time limit operation with automatic resetting.
- DIN size (36 × 36 mm), fits standard 8-pin sockets.
- Wide choice of supply voltages:  
24, 100 to 120, 200 to 240 VAC, 12, 24 VDC.
- Dual LED indication for power and output statuses.
- Large transparent setting knob.
- Setting error rating almost matches that of a 48 × 48 timer.
- Conforms to UL and CSA, and meets CE marking requirements.



### Ordering Information

Operation/resetting system	Time-limit contact	Mounting method	Rated time	Model
Time-limit operation/ self-resetting	SPDT	Surface mounting, flush mounting, and DIN track mounting	1 s, 3 s, 5 s, 10 s, 30 s, 60 s, 3 min, 5 min, 10 min, 30 min, 60 min, 3 hrs	H3JA-8A
	DPDT			H3JA-8C

**Note:** Specify the model number, supply voltage, and rated time when ordering.

Ex. H3JA-8A 100 to 120 VAC 1 s  
 └──────────────────┬──────────┘  
 Supply voltage      Rated time

### ■ Accessories (Order Separately)

Name/specifications		Models
Flush Mounting Adapter		Y92F-31
Mounting Track	50 cm (ℓ) × 7.3 mm (t)	PFP-50N
	1 m (ℓ) × 7.3 mm (t)	PFP-100N
	1 m (ℓ) × 16 mm (t)	PFP-100N2
End Plate		PFP-M
Spacer		PFP-S
Track Mounting/ Front Connecting Socket	8-pin	PF085A
Back Connecting Socket	8-pin	US08
	8-pin	P3G-08
	8-pin, finger safe type	P3G-08 with Y92A-48G (see note 1)
Hold-down Clip (see note 2)	For PF085A Socket	Y92H-6

**Note:** 1. Y92A-48G is a finger safe terminal cover which is attached to the P3G-08 Socket.

2. Hold-down Clips are sold in sets of two.

# Specifications

## ■ Time Ranges

Rated time	Time range	Rated time	Time range
1 s	0.1 to 1 s	3 min	0.3 to 3 min
3 s	0.3 to 3 s	5 min	0.5 to 5 min
5 s	0.5 to 5 s	10 min	1 to 10 min
10 s	1 to 10 s	30 min	3 to 30 min
30 s	3 to 30 s	60 min	6 to 60 min
60 s	6 to 60 s	3 hrs	0.3 to 3 hrs

## ■ Ratings

<b>Rated supply voltage</b>	24, 100 to 120 or 200 to 240 VAC (50/60 Hz); 12, 24 VDC
<b>Operating voltage range</b>	85% to 110% of rated supply voltage
<b>Power consumption</b>	<p><u>H3JA-8A</u></p> <p>100 to 120 VAC: Approx. 2.6 VA (1.1 W) at 120 VAC            200 to 240 VAC: Approx. 5.0 VA (1.5 W) at 240 VAC            24 VAC: Approx. 1.0 VA (0.9 W) at 24 VAC            24 VDC: Approx. 0.8 W at 24 VDC            12 VDC: Approx. 0.5 W at 12 VDC</p> <p><u>H3JA-8C</u></p> <p>100 to 120 VAC: Approx. 2.4 VA (0.9 W) at 120 VAC            200 to 240 VAC: Approx. 4.1 VA (1.1 W) at 240 VAC            24 VAC: Approx. 1.2 VA (1.0 W) at 24 VAC            24 VDC: Approx. 0.8 W at 24 VDC</p>
<b>Control outputs</b>	H3JA-8A: 7 A at 250 VAC, resistive load H3JA-8C: 5 A at 250 VAC, resistive load

## ■ Characteristics

<b>Accuracy of operating time</b>	±2% max. (full scale)
<b>Setting error</b>	±7% max. (full scale) ±50 ms at 20°C
<b>Influence of voltage</b>	±2% max. (full scale)
<b>Influence of temperature</b>	±5% max. (full scale)
<b>Insulation resistance</b>	100 MΩ min. (at 500 VDC)
<b>Dielectric strength</b>	2,000 VAC, 50/60 Hz for 1 min (between current-carrying and non-current-carrying parts, and between contact-carrying and control circuit, and between contacts of different poles) 750 VAC, 50/60 Hz for 1 min (between non-continuous contacts: H3JA-8A) 1,000 VAC, 50/60 Hz for 1 min (between non-continuous contacts: H3JA-8C)
<b>Impulse withstand voltage</b>	3 kV (between power terminals) 4.5 kV (between current-carrying terminal and exposed non-current-carrying metal parts)
<b>Noise immunity</b>	±1.5 kV (between power terminals) and ±1.5 kV (between output terminals), square-wave noise by noise simulator (pulse width: 100 ns/1 μs, 1-ns rise)
<b>Static immunity</b>	Destruction: 8 kV Malfunction: 6 kV
<b>Vibration resistance</b>	Destruction: 10 to 55 Hz with 0.75-mm double amplitude in 3 directions for 1 hour each. Malfunction: 10 to 55 Hz with 0.5-mm double amplitude in 3 directions for 10 minutes each.
<b>Shock resistance</b>	Destruction: 1,000 m/s <sup>2</sup> Malfunction: 100 m/s <sup>2</sup>
<b>Ambient temperature</b>	Operating: -10°C to 55°C Storage: -25°C to 65°C
<b>Ambient humidity</b>	Operating: 35% to 85%
<b>Life expectancy</b>	<b>H3JA-8A</b> Mechanical: 10,000,000 operations min. Electrical: 60,000 operations min. (7 A resistive load at 250 VAC, 360 operations/h) <b>H3JA-8C</b> Mechanical: 10,000,000 operations min. Electrical: 100,000 operations min. (5 A resistive load at 250 VAC, 360 operations/h)
<b>EMC</b>	(EMI) Emission Enclosure: EN55011 Group 1 class B Emission AC Mains: EN55011 Group 1 class B Harmonic Current: EN61000-3-2 Voltage Fluctuation and Flickering: EN61000-3-3  (EMS) Immunity ESD: EN61000-4-2: 6 kV contact discharge (level 3) 8 kV air discharge (level 3) Immunity RF-interference from AM Radio Waves: EN61000-4-3: 10 V/m (80 MHz to 1 GHz) (level 3) Immunity Burst: EN61000-4-4: 2 kV power port and output port (level 3) 1 kV control port with capacitive clamp (level 3) Immunity Surge: EN61000-4-5: 2 kV common mode (level 3) 1 kV differential mode (level 3)
<b>Approved standard</b>	UL508 (See note.), CSA C22.2 No. 14, conforms to EN61812-1 (Pollution degree 2)
<b>Case color</b>	Light gray (Munsell 5Y7/1)
<b>Degree of protection</b>	IP40 (panel surface)
<b>Weight</b>	H3JA-8A: Approx. 50 g H3JA-8C: Approx. 60 g

**Note:** The surrounding air temperature (operating) is -10 to 40°C.

# Engineering Data

H3JA-8A

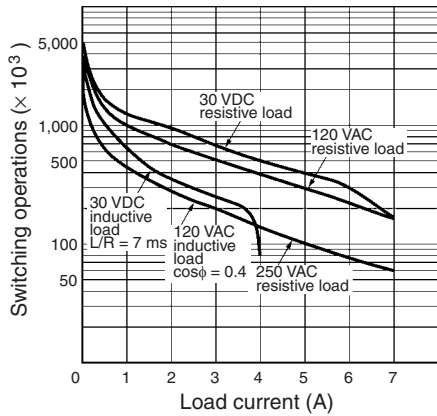

H3JA-8C

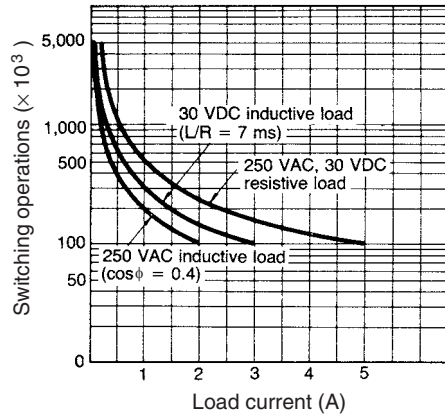

## Operation

### ■ Timing Chart

H3JA-8A

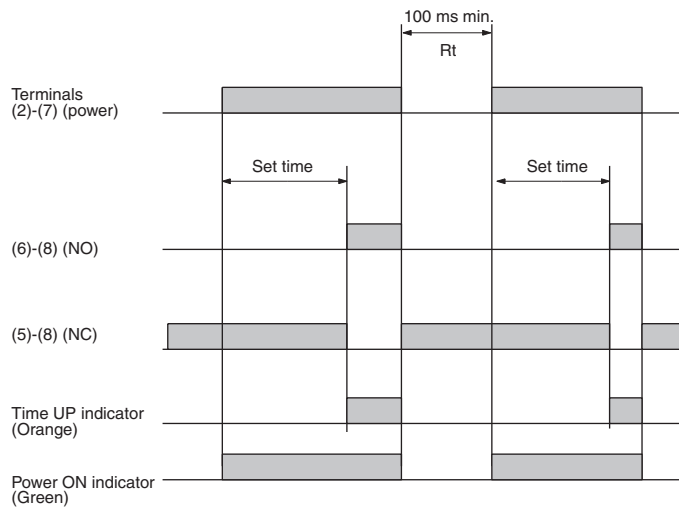

H3JA-8C

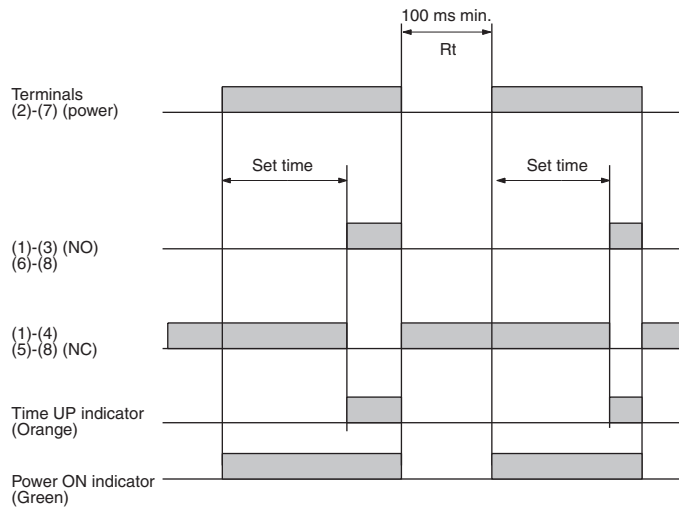

# Dimensions

**Note:** All units are in millimeters unless otherwise indicated.

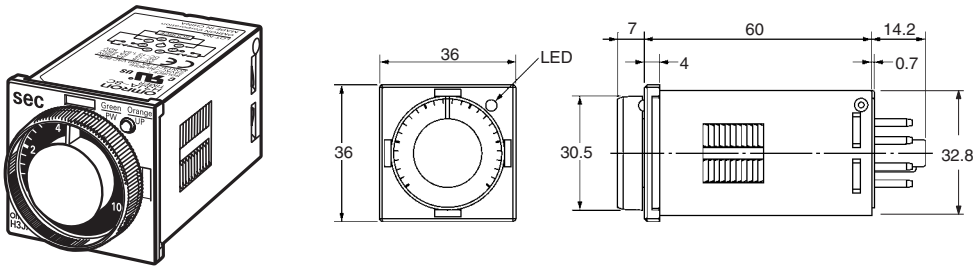

## ■ Accessories (Order Separately)

### Flush Mounting Adapter

#### Y92F-31

Adapter Y92F-31 shown with H3JA-8□ and back connecting socket.

### Panel Cutout

Recommended panel thickness: 1 to 5 mm

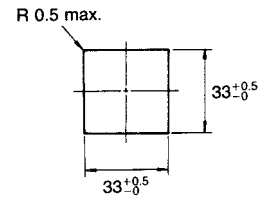
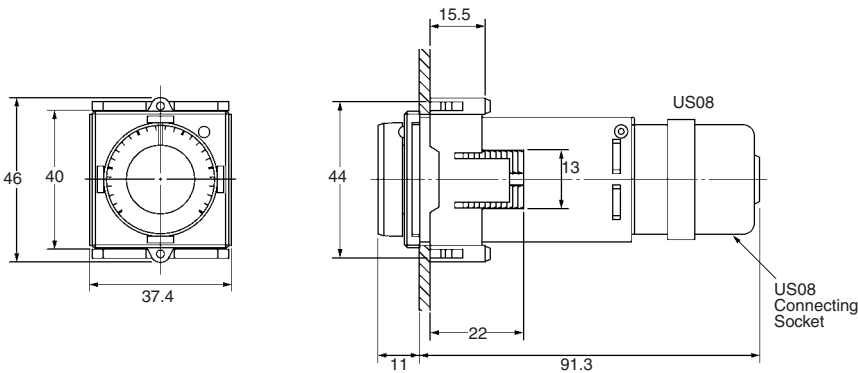

### Track Mounting/Front Connecting Socket

#### PF085A

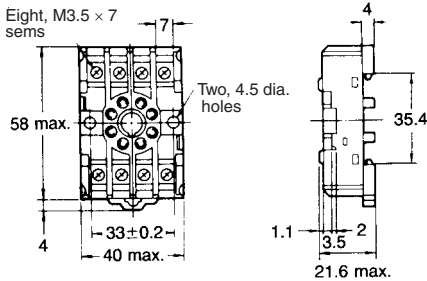

### Terminal Arrangement (Top View)

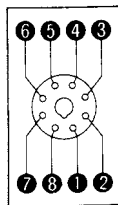

### Mounting Holes

Two, M4 or 4.5 dia. holes

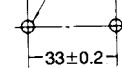

### Mounting Height of Timer with Socket

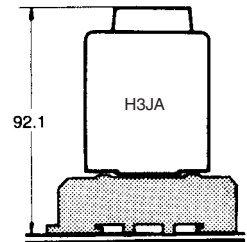

**Note:** PF085A can be used as a front connecting socket.

### Hold-down Clips (Set of Two Clips)

#### Y92H-6 for PF085A Socket

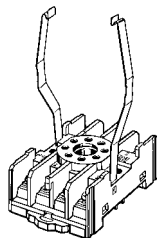
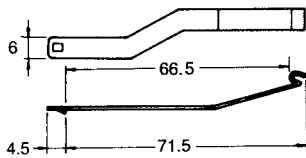

**Back Connecting Socket**

**US08**

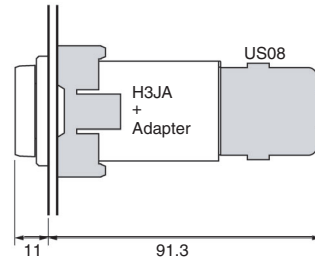
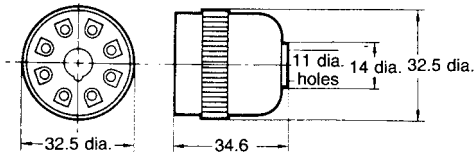

**P3G-08**

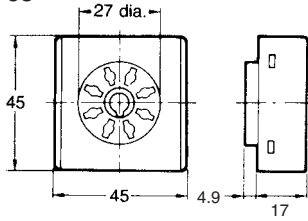

**Terminal Arrangement (Bottom View)**

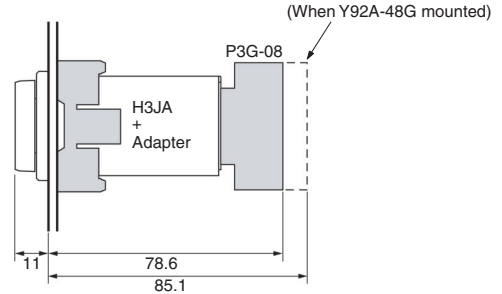
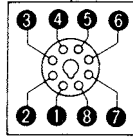

**Finger Safe Terminal Cover  
Conforming to VDE0106/P100**

**Y92A-48G  
(Attachment for P3G-08  
Socket)**

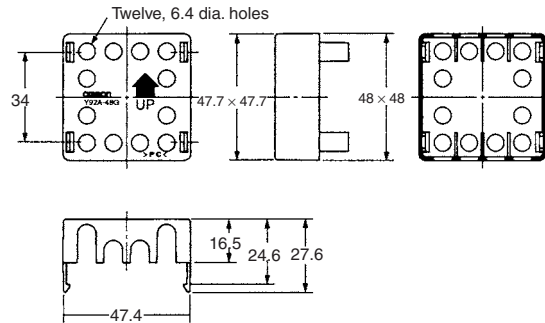
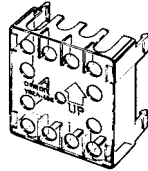

**Mounting Track  
PFP-100N, PFP-50N**

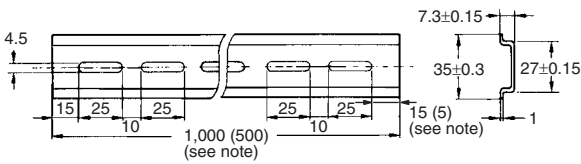
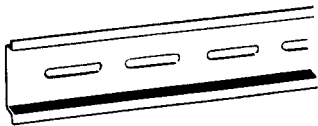

**PFP-100N2**

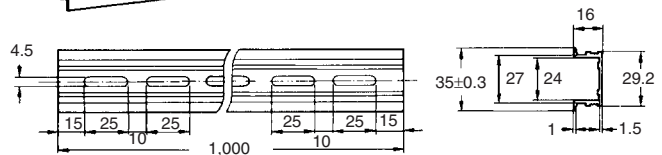
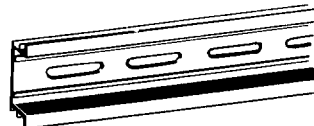

**Note:** The values shown in parentheses are for the PFP-50N.

**End Plate**  
PFP-M

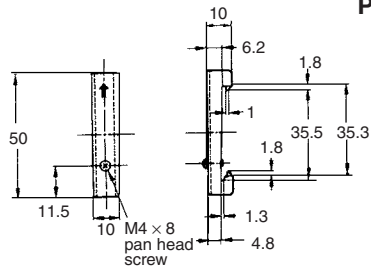
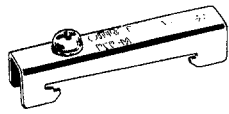

**Spacer**  
PFP-S

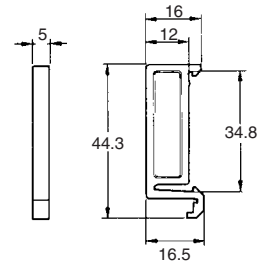
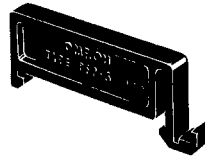

## Installation

### ■ Terminal Arrangement

H3JA-8A

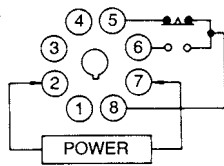

H3JA-8C

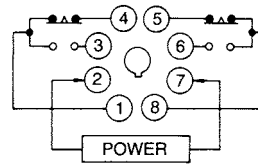

**ALL DIMENSIONS SHOWN ARE IN MILLIMETERS.**

To convert millimeters into inches, multiply by 0.03937. To convert grams into ounces, multiply by 0.03527.

Cat. No. L110-E1-01A **In the interest of product improvement, specifications are subject to change without notice.**

## **OMRON Corporation**

Industrial Automation Company

**Control Devices Division H.Q.**

**Analog Controller Division**

Shiokoji Horikawa, Shimogyo-ku,

Kyoto, 600-8530 Japan

Tel: (81)75-344-7080/Fax: (81)75-344-7189

0707



# Mouser Electronics

Authorized Distributor

Click to View Pricing, Inventory, Delivery & Lifecycle Information:

[Omron:](#)

[H3JA-8C AC100-120 1S](#) [H3JA-8C DC24 10S](#) [H3JA-8C-AC100-120-5M](#) [H3JA-8C-AC100-120-60S](#) [H3JA-8C-AC100-120-60M](#) [H3JA-8C-AC100-120-10S](#) [H3JA-8C-AC100-120-10M](#) [H3JA-8C-AC100-120-30S](#) [PF085A](#)