

## UCS1001-3 UCS1001-4

# USB Port Power Controller with Charger Emulation

## PRODUCT FEATURES

Datasheet

### General Description

The UCS1001 provides a USB port power switch for precise control of up to 2.5 amperes continuous current with over-current limit (OCL), dynamic thermal management, latch or auto-recovery (low test current) fault handling, selectable active low or high enable, under- and over-voltage lockout, back-drive protection, and back-voltage protection.

Split supply support for VS and VDD is an option for low power in system standby states. This gives battery operated applications, like notebook PCs, the ability to detect attachments from a sleep or off state. After the Attach Detection is flagged, the system can decide to wake up and/or provide charging.

In addition to power switching and current limiting modes, the UCS1001 will automatically charge a wide variety of portable devices, including USB-IF BC1.2, YD/T-1591 (2009), most Apple<sup>®</sup> and RIM<sup>®</sup>, and many others. Nine preloaded charger emulation profiles maximize compatibility coverage of peripheral devices.

The UCS1001 is available in a 20-pin QFN 4 mm x 4 mm package.

### Applications

- Notebook and Netbook Computers
- Tablets and E-book readers
- Desktops and Monitors
- Docking Stations and Printers
- AC-DC wall adapters

### Features

- Port power switch with two current limit behaviors
  - 2.9 V to 5.5 V source voltage range
  - Up to 2.5 A current with 55 mΩ On Resistance
  - Over-current trip or constant current limiting
  - Soft turn-on circuitry
  - Selectable current limit
  - Dynamic thermal management
  - Under- and over-voltage lockout
  - Back-drive, back-voltage protection
  - Latch or auto-recovery (low test current) fault handling
  - Selectable active high or low power switch enable
  - BC1.2 VBUS discharge port renegotiation function
- Selectable / automatic cycling of USB data line charger emulation profiles
  - Employs unique method and system for sampling multiple profiles\*
  - UCS1001-3 and UCS1001-4 supports 12W charger emulation
  - Allows for active cables
  - USB-IF BC1.2 charging downstream port (CDP) & dedicated charging port (DCP) modes, YD/T-1591, and most Apple and RIM protocols standard
  - USB 2.0 compliant high-speed data switch (in Pass-through and CDP modes)
  - Nine preloaded charger emulation profiles for maximum compatibility coverage of peripheral devices
- Charging Active (UCS1001-3) or Attach Detection (UCS1001-4) open-drain output
- Ultra low power Sleep state
- Optional split supply support for VBUS and VDD for low power in system standby states
- Wake on Attach USB (UCS1001-4)
- Wide operating temperature range: -40 °C to +85 °C
- IEC61000-4-2 8 / 15 kV ESD immunity
- UL recognized and EN/IEC 60950-1 (CB) certified

\* Unique technology covered under the following US patents pending: 13/109,446; 13/149,529; 13/173,287; 13/233,949; 13/157,282; 12/978,371; 13/232,965.

**Block Diagram**



**ORDERING INFORMATION:**

ORDERING NUMBER	PACKAGE	FEATURES
UCS1001-3-BP-TR	20 pin QFN 4mm x 4mm (RoHS compliant)	USB Port Power Controller with Charger Emulation, 12W Emulation support, and charging active output indicator
UCS1001-4-BP-TR	20 pin QFN 4mm x 4mm (RoHS compliant)	USB Port Power Controller with Charger Emulation, 12W Emulation support, and portable device attachment detected output indicator

**REEL SIZE IS 4,000 PIECES**

**This product meets the halogen maximum concentration values per IEC61249-2-21**

**For RoHS compliance and environmental information, please visit [www.smSC.com/rohs](http://www.smSC.com/rohs)**

*Please contact your SMSC sales representative for additional documentation related to this product such as application notes, anomaly sheets, and design guidelines.*

Copyright © 2013 SMSC or its subsidiaries. All rights reserved.

Circuit diagrams and other information relating to SMSC products are included as a means of illustrating typical applications. Consequently, complete information sufficient for construction purposes is not necessarily given. Although the information has been checked and is believed to be accurate, no responsibility is assumed for inaccuracies. SMSC reserves the right to make changes to specifications and product descriptions at any time without notice. Contact your local SMSC sales office to obtain the latest specifications before placing your product order. The provision of this information does not convey to the purchaser of the described semiconductor devices any licenses under any patent rights or other intellectual property rights of SMSC or others. All sales are expressly conditional on your agreement to the terms and conditions of the most recently dated version of SMSC's standard Terms of Sale Agreement dated before the date of your order (the "Terms of Sale Agreement"). The product may contain design defects or errors known as anomalies which may cause the product's functions to deviate from published specifications. Anomaly sheets are available upon request. SMSC products are not designed, intended, authorized or warranted for use in any life support or other application where product failure could cause or contribute to personal injury or severe property damage. Any and all such uses without prior written approval of an Officer of SMSC and further testing and/or modification will be fully at the risk of the customer. Copies of this document or other SMSC literature, as well as the Terms of Sale Agreement, may be obtained by visiting SMSC's website at <http://www.smSC.com>. SMSC is a registered trademark of Standard Microsystems Corporation ("SMSC"). Product names and company names are the trademarks of their respective holders.

The Microchip name and logo, and the Microchip logo are registered trademarks of Microchip Technology Incorporated in the U.S.A. and other countries.

**SMSC DISCLAIMS AND EXCLUDES ANY AND ALL WARRANTIES, INCLUDING WITHOUT LIMITATION ANY AND ALL IMPLIED WARRANTIES OF MERCHANTABILITY, FITNESS FOR A PARTICULAR PURPOSE, TITLE, AND AGAINST INFRINGEMENT AND THE LIKE, AND ANY AND ALL WARRANTIES ARISING FROM ANY COURSE OF DEALING OR USAGE OF TRADE. IN NO EVENT SHALL SMSC BE LIABLE FOR ANY DIRECT, INCIDENTAL, INDIRECT, SPECIAL, PUNITIVE, OR CONSEQUENTIAL DAMAGES; OR FOR LOST DATA, PROFITS, SAVINGS OR REVENUES OF ANY KIND; REGARDLESS OF THE FORM OF ACTION, WHETHER BASED ON CONTRACT; TORT; NEGLIGENCE OF SMSC OR OTHERS; STRICT LIABILITY; BREACH OF WARRANTY; OR OTHERWISE; WHETHER OR NOT ANY REMEDY OF BUYER IS HELD TO HAVE FAILED OF ITS ESSENTIAL PURPOSE, AND WHETHER OR NOT SMSC HAS BEEN ADVISED OF THE POSSIBILITY OF SUCH DAMAGES.**

## Table of Contents

<b>Chapter 1 Terms and Abbreviations</b> .....	<b>8</b>
<b>Chapter 2 Pin Description</b> .....	<b>10</b>
<b>Chapter 3 Electrical Specifications</b> .....	<b>14</b>
3.1 ESD & Transient Performance .....	23
3.1.1 Human Body Model (HBM) Performance .....	23
3.1.2 Charged Device Model (CDM) Performance .....	23
3.1.3 IEC61000-4-2 Performance .....	23
<b>Chapter 4 General Description</b> .....	<b>24</b>
4.1 UCS1001 Power States .....	28
4.1.1 Off State Operation .....	29
4.1.2 Sleep State Operation .....	30
4.1.3 Detect State Operation .....	30
4.1.4 Active State Operation .....	31
4.1.5 Error State Operation .....	32
4.2 Supply Voltages .....	32
4.2.1 VDD Supply Voltage .....	32
4.2.2 VS Source Voltage .....	32
4.2.3 Back-voltage Detection .....	33
4.2.4 Back-drive Current Protection .....	33
4.2.5 Under-voltage Lockout on VS .....	33
4.2.6 Over-voltage Detection and Lockout on VS .....	33
4.3 Discrete Input Pins .....	33
4.3.1 ILIM Input .....	33
4.3.2 SEL Input .....	33
4.3.3 M1, M2, and EM_EN Inputs .....	34
4.3.4 PWR_EN Input .....	34
4.3.5 Latch Input .....	34
4.3.6 S0 Input .....	34
4.4 Discrete Output Pins .....	34
4.4.1 ALERT# and A_DET# Output Pins .....	34
4.4.2 Interrupt Blanking .....	34
<b>Chapter 5 USB High-speed Data Switch</b> .....	<b>35</b>
5.1 USB High-speed Data Switch .....	35
5.1.1 USB-IF High-speed Compliance .....	35
<b>Chapter 6 USB Port Power Switch</b> .....	<b>36</b>
6.1 USB Port Power Switch .....	36
6.2 Current Limiting .....	36
6.2.1 Current Limit Setting .....	36
6.2.2 Short Circuit Output Current Limiting .....	36
6.2.3 Soft Start .....	37
6.2.4 Current Limiting Modes .....	37
6.3 Thermal Management and Voltage Protection .....	39
6.3.1 Thermal Management .....	39

6.4 VBUS Discharge . . . . .	41
6.5 Fault Handling Mechanism . . . . .	41
6.5.1 Auto-recovery Fault Handling . . . . .	41
6.5.2 Latched Fault Handling . . . . .	41
<hr/>	
<b>Chapter 7 Detect State . . . . .</b>	<b>42</b>
7.1 Device Attach / Removal Detection . . . . .	42
7.2 VBUS Bypass Switch . . . . .	42
7.3 Attach Detection . . . . .	42
7.4 Removal Detection . . . . .	42
<hr/>	
<b>Chapter 8 Active State . . . . .</b>	<b>43</b>
8.1 Active State Overview . . . . .	43
8.2 Active Mode Selection . . . . .	43
8.3 BC1.2 Detection Renegotiation . . . . .	43
8.4 Data Pass-through (No Charger Emulation) . . . . .	43
8.5 BC1.2 SDP (No Charger Emulation) . . . . .	44
8.6 BC1.2 CDP . . . . .	44
8.6.1 BC1.2 CDP Charger Emulation Profile . . . . .	44
8.7 BC1.2 DCP . . . . .	45
8.7.1 BC1.2 DCP Charger Emulation Profile . . . . .	45
8.8 Dedicated Charger . . . . .	45
8.8.1 Emulation Reset . . . . .	45
8.8.2 Emulation Cycling . . . . .	46
8.8.3 DCE Cycle Retry . . . . .	46
8.9 Current Limit Mode Associations . . . . .	46
8.10 Preloaded Charger Emulation Profiles . . . . .	47
8.10.1 Legacy 1 Charger Emulation Profile . . . . .	47
8.10.2 Legacy 2, 4, 5, and 7 Charger Emulation Profiles . . . . .	47
8.10.3 Legacy 3 Charger Emulation Profile . . . . .	48
8.10.4 Legacy 6 Charger Emulation Profile . . . . .	48
<hr/>	
<b>Chapter 9 Package Information . . . . .</b>	<b>49</b>
<hr/>	
<b>Chapter 10 Typical Operating Curves . . . . .</b>	<b>51</b>
<hr/>	
<b>Chapter 11 Document Revision History . . . . .</b>	<b>55</b>

## List of Figures

Figure 2.1	UCS1001-3 Pin Diagram	10
Figure 2.2	UCS1001-4 Pin Diagram	11
Figure 3.1	USB Rise Time / Fall Time Measurement	21
Figure 3.2	Description of DC Terms	22
Figure 4.1	UCS1001-3 System Configuration (No Charger Emulation)	24
Figure 4.2	UCS1001-4 System Configuration (No Charger Emulation)	25
Figure 4.3	UCS1001-3 System Configuration (No USB Host, with Charger Emulation)	26
Figure 4.4	UCS1001-4 System Configuration (No USB Host, with Charger Emulation)	27
Figure 4.5	Wake Timing	30
Figure 6.1	Trip Current Limiting Operation	38
Figure 6.2	Constant Current Limiting (Variable Slope) Operation	39
Figure 9.1	UCS1001 Package View	49
Figure 9.2	UCS1001 Package Dimensions and Notes	50
Figure 10.1	USB-IF High-speed Eye Diagram (without data switch)	51
Figure 10.2	USB-IF High-speed Eye Diagram (with data switch)	51
Figure 10.3	Short Applied After Power Up	51
Figure 10.4	Power Up Into A Short	51
Figure 10.5	Internal Power Switch Short Response	51
Figure 10.6	VBUS Discharge Behavior	51
Figure 10.7	Data Switch Off Isolation vs. Frequency	52
Figure 10.8	Data Switch Bandwidth vs. Frequency	52
Figure 10.9	Data Switch On Resistance vs. Temp	52
Figure 10.10	Power Switch On Resistance vs. Temp	52
Figure 10.11	$R_{DCP\_RES}$ Resistance vs. Temp	52
Figure 10.12	Power Switch On / Off Time vs. Temp	52
Figure 10.13	VS Over-Voltage Threshold vs. Temp	53
Figure 10.14	VS Under Voltage Threshold vs. Temp	53
Figure 10.15	Detect State VBUS vs. IBUS	53
Figure 10.16	Trip Current Limit Operation vs. Temp	53
Figure 10.17	IBUS Measurement Accuracy	53
Figure 10.18	Active State Current vs. Temp	54
Figure 10.19	Detect State Current vs. Temp	54
Figure 10.20	Sleep State Current vs. Temp	54

## List of Tables

Table 1.1	Terms and Abbreviations	8
Table 2.1	UCS1001 Pin Description	11
Table 2.2	Pin Types	13
Table 3.1	Absolute Maximum Ratings	14
Table 3.2	Power Dissipation Summary	14
Table 3.3	Electrical Specifications	15
Table 3.4	ESD Ratings	23
Table 4.1	Power States Control Settings	29
Table 6.1	UCS1001 ILIM Selection	36
Table 8.1	Active Mode Selection	43
Table 8.2	Current Limit Mode Options	46
Table 11.1	Customer Revision History	55

## Chapter 1 Terms and Abbreviations

**APPLICATION NOTE:** The M1, M2, PWR\_EN, and EM\_EN pins are referenced in text as the <pin name> control.

**Table 1.1 Terms and Abbreviations**

<b>TERM / ABBREVIATION</b>	<b>DESCRIPTION</b>
Active mode	Active power state operation mode: Data Pass-through, BC1.2 SDP, BC1.2 CDP, BC1.2 DCP, or Dedicated Charger Emulation Cycle.
attachment	The physical insertion of a portable device into a USB port that UCS1001 is controlling.
CC	Constant current
CDM	Charged Device Model. JEDEC model for characterizing susceptibility of a device to damage from ESD.
CDP or USB-IF BC1.2 CDP	Charging downstream port. The combination of the UCS1001 CDP handshake and an active standard USB host comprises a CDP. This enables a BC1.2 compliant portable device to simultaneously draw current up to 1.5 A while data communication is active. The USB high-speed data switch is closed in this mode.
charge enable	When a charger emulation profile has been accepted by a portable device and charging commences.
charger emulation profile	Representation of a charger comprised of DPOUT, DMOUT, and VBUS signalling which make up a defined set of signatures or handshaking protocols.
connection	USB-IF term which refers to establishing active USB communications between a USB host and a USB device.
current limiting mode	Determines the action that is performed when the IBUS current reaches the ILIM threshold. Trip opens the port power switch. Constant current (variable slope) allows VBUS to be dropped by the portable device.
DCE	Dedicated charger emulation. Charger emulation in which the UCS1001 can deliver power only. No active USB data communication is possible when charging in this mode.
DCP or USB-IF BC1.2 DCP	Dedicated Charging Port. This functions as a dedicated charger for a BC1.2 portable device. This allows the portable device to draw currents up to 1.5 A with constant current limiting (and beyond 1.5 A with trip current limiting). No USB communications are possible.
DC	Dedicated charger. A charger which inherently does not have USB communications, such as an A/C wall adapter.
disconnection	USB-IF term which refers to the loss of active USB communications between a USB host and a USB device.
dynamic thermal management	The UCS1001 automatically adjusts port power switch limits and modes to lower internal power dissipation when the thermal regulation temperature value is approached.
enumeration	A USB-specific term that indicates that a host is detecting and identifying USB devices.
handshake	Application of a charger emulation profile that requires a response. Two-way communication between the UCS1001 and the portable device.
HBM	Human Body Model.
HSW	High-speed switch.



**Table 1.1 Terms and Abbreviations (continued)**

<b>TERM / ABBREVIATION</b>	<b>DESCRIPTION</b>
$I_{BUS\_R2MIN}$	Current limiter mode boundary.
ILIM	The IBUS current threshold used in current limiting. In trip mode, when ILIM is reached, the port power switch is opened. In constant current mode, when the current exceeds ILIM, operation continues at a reduced voltage and increased current; if VBUS voltage drops below $V_{BUS\_MIN}$ , the port power switch is opened.
Legacy	USB devices that require non-BC1.2 signatures be applied on the DPOUT and DMOUT pins to enable charging.
OCL	Over-current limit.
portable device	USB device attached to the USB port.
power thief	A USB device that does not follow the handshaking conventions of a BC1.2 device or Legacy devices and draws current immediately upon receiving power (i.e., a USB book light, portable fan, etc).
removal	The physical removal of a portable device from a USB port that the UCS1001 is controlling.
SDP or USB-IF SDP	Standard downstream port. The combination of the UCS1001 high-speed switch being closed with an upstream USB host present comprises a BC1.2 SDP. This enables a BC1.2 compliant portable device to simultaneously draw current up to 0.5 A while data communication is active.
signature	Application of a charger emulation profile without waiting for a response. One-way communication from the UCS1001 to the portable device.

## Chapter 2 Pin Description



Figure 2.1 UCS1001-3 Pin Diagram

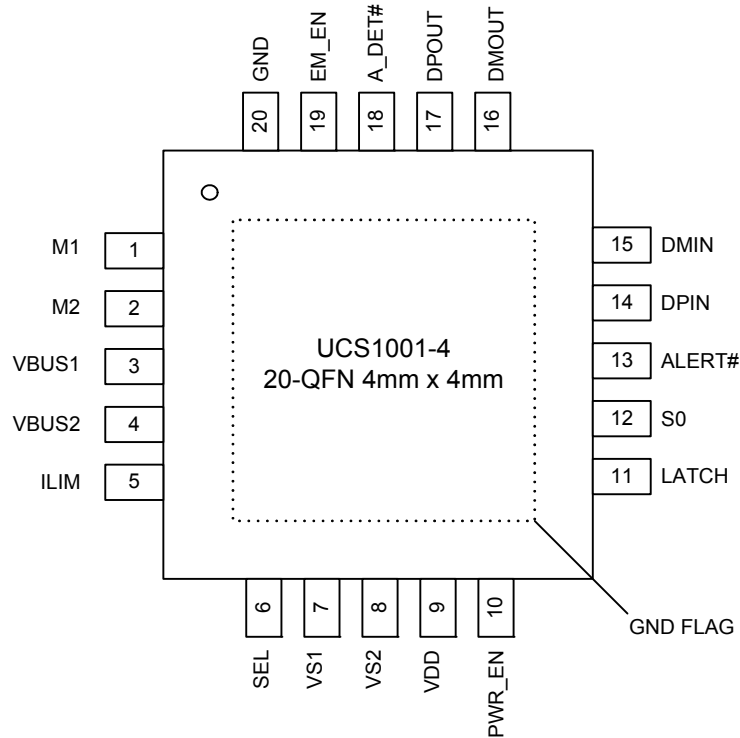

**Figure 2.2 UCS1001-4 Pin Diagram**

The pin types are described in [Table 2.2](#). All pins are 5 V tolerant.

**Table 2.1 UCS1001 Pin Description**

PIN NUMBER	PIN NAME	PIN FUNCTION	PIN TYPE	IF PIN NOT USED CONNECTION
1	M1	Active mode selector input #1	DI	Connect to ground or VDD (see <a href="#">Note 2.2</a> )
2	M2	Active mode selector input #2	DI	Connect to ground or VDD (see <a href="#">Note 2.2</a> )
3	VBUS1	Voltage output from Power Switch. These pins must be tied together.	Hi-Power, AIO <a href="#">Note 2.1</a>	Leave open
4	VBUS2			
5	ILIM	Selects the maximum current limit at power-up	AIO	n/a
6	SEL	Selects polarity of PWR_EN control	DI	n/a
7	VS1	Voltage input to Power Switch. These pins must be tied together.	Hi-Power, AIO	Connect to ground
8	VS2			

Table 2.1 UCS1001 Pin Description (continued)

PIN NUMBER	PIN NAME	PIN FUNCTION	PIN TYPE	IF PIN NOT USED CONNECTION
9	VDD	Main power supply input for chip functionality	Power	n/a
10	PWR_EN	Port power switch enable input. Polarity determined by SEL pin.	DI	Connect to ground or VDD (see <a href="#">Note 2.2</a> )
11	LATCH	Latch / Auto-recovery fault handling mechanism selection input	DI	n/a
12	S0	Enables Attach / Removal Detection feature	DI	n/a
13	ALERT#	Active low error event output flag (requires pull-up resistor)	OD	Connect to ground
14	DPIN	USB data input (plus)	AIO	Connect to ground or ground through a resistor
15	DMIN	USB data input (minus)	AIO	Connect to ground or ground through a resistor
16	DMOUT	USB data output (minus)	AIO	Connect to ground
17	DPOUT	USB data output (plus)	AIO	Connect to ground
18 (UCS1001-1, UCS1001-3)	CHRG#	Active low "Charging Active" output flag (requires pull-up resistor)	OD	Connect to ground
18 (UCS1001-2, UCS1001-4)	A_DET#	Active low Attach Detection output flag (requires pull-up resistor)	OD	Connect to ground
19	EM_EN	Active mode selector input	DI	Connect to ground or VDD (see <a href="#">Note 2.2</a> )
20	GND	Ground	Power	n/a
Bottom Pad	GND FLAG	Thermal connection to ground plane	Thermal Pad	n/a

**Note 2.1** Total leakage current from pins 3 and 4 (VBUS) to ground must be less than 100  $\mu$ A for proper attach / removal detection operation.

**Note 2.2** To ensure operation, the PWR\_EN pin must be enabled, as determined by the SEL pin decode, when it is not driven by an external device. Furthermore, one of the M1, M2, or EM\_EN pins must be connected to VDD if all three are not driven from an external device. If the PWR\_EN is disabled or all of the M1, M2, and EM\_EN are connected to ground, the UCS1001 will remain in the Sleep or Detect state indefinitely.

**Table 2.2 Pin Types**

<b>PIN TYPE</b>	<b>DESCRIPTION</b>
Power	This pin is used to supply power or ground to the device.
Hi-Power	This pin is a high current pin.
AIO	Analog Input / Output - this pin is used as an I/O for analog signals.
DI	Digital Input - this pin is used as a digital input.
OD	Open-drain Digital Output - used as a digital output. It is open-drain and requires a pull-up resistor.

## Chapter 3 Electrical Specifications

**Table 3.1 Absolute Maximum Ratings**

Voltage on VDD, VS, and VBUS pins	-0.3 to 6	V
Pullup voltage ( $V_{PULLUP}$ )	-0.3 to VDD + 0.3	
Data switch current ( $I_{HSW\_ON}$ ), switch on	±50	mA
Port power switch current	Internally limited	
Data switch pin voltage to ground (DPOUT, DPIN, DMOUT, DMIN); (VDD powered or unpowered)	-0.3 to VDD + 0.3	V
Differential voltage across open data switch (DPOUT - DPIN, DMOUT - DMIN, DPIN - DPOUT, DMIN - DMOUT)	VDD	V
Voltage on any other pin to ground	-0.3 to VDD + 0.3	V
Current on any other pin	±10	mA
Package power dissipation	See <a href="#">Table 3.2</a>	
Operating ambient temperature range	-40 to 125	°C
Storage temperature range	-55 to 150	°C

**Note:** Stresses above those listed could cause permanent damage to the UCS1001. This is a stress rating only and functional operation of the UCS1001 at any other condition above those indicated in the operation sections of this specification is not implied.

**Table 3.2 Power Dissipation Summary**

BOARD	PKG	$\theta_{JC}$	$\theta_{JA}$	DERATING FACTOR ABOVE 25 °C	TA < 25 °C POWER RATING	TA = 70 °C POWER RATING	TA = 85 °C POWER RATING
High K (see <a href="#">Note 3.1</a> )	20-pin QFN 4 mm x 4 mm	6 °C / W	41 °C / W	24.4 mW / °C	2193 mW	1095 mW	729 mW
Low K (see <a href="#">Note 3.1</a> )	20-pin QFN 4 mm x 4 mm	6 °C / W	60 °C / W	16.67 mW / °C	1498 mW	748 mW	498 mW

**Note 3.1** A High K board uses a thermal via design with the thermal landing soldered to the PCB ground plane with 0.3 mm (12 mil) diameter vias in a 3x3 matrix (9 total) at 0.5 mm (20 mil) pitch. The board is multi-layer with 1-ounce internal power and ground planes and 2-ounce copper traces on top and bottom. A Low K board is a two layer board without thermal via design with 2-ounce copper traces on the top and bottom.

**Table 3.3 Electrical Specifications**

VDD = 4.5 V to 5.5 V, VS = 2.9 V to 5.5 V, VPULLUP = 3 V to 5.5 V, = -40 °C to all Typical values at VDD = VS = 5 V, TA = 27 °C unless otherwise noted.						
CHARACTERISTIC	SYMBOL	MIN	TYP	MAX	UNIT	CONDITIONS
Power and Interrupts - DC						
Supply Voltage	VDD	4.5	5	5.5	V	See <a href="#">Note 3.2</a>
Source Voltage	VS	2.9	5	5.5	V	See <a href="#">Note 3.2</a>
Supply Current in Active ( $I_{DD\_ACTIVE} + I_{VS\_ACT}$ )	$I_{ACTIVE}$		650	750	$\mu A$	Average current IBUS = 0 mA
Supply Current in Sleep ( $I_{DD\_SLEEP} + I_{VS\_SLEEP}$ )	$I_{SLEEP}$		5	15	$\mu A$	Average current $V_{PULLUP} \leq VDD$
Supply Current in Detect ( $I_{DD\_DETECT} + I_{VS\_DETECT}$ )	$I_{DETECT}$		185	220	$\mu A$	Average current No portable device attached.
Power-on Reset						
VS Low Threshold	$V_{S\_UVLO}$		2.5		V	VS voltage increasing
VS Low Hysteresis	$V_{S\_UVLO\_HYST}$		100		mV	VS voltage decreasing
VDD Low Threshold	$V_{DD\_TH}$		4		V	VDD voltage increasing
VDD Low Hysteresis	$V_{DD\_TH\_HYST}$		500		mV	VDD voltage decreasing
I/O Pins - EM_EN, M1, M2, PWR_EN, ALERT#, CHRG# (UCS1001-3), A_DET# (UCS1001-4)- DC Parameters						
Output Low Voltage	$V_{OL}$			0.4	V	$I_{SINK\_IO} = 8\text{ mA}$ ALERT#CHRG#, A_DET#
Input High Voltage	$V_{IH}$	2.0			V	PWR_EN, EM_EN, M1, M2
Input Low Voltage	$V_{IL}$			0.8	V	PWR_EN, EM_EN, M1, M2, EM_EN
Leakage Current	$I_{LEAK}$			$\pm 5$	$\mu A$	Powered or unpowered $V_{PULLUP} \leq VDD$ $T_A < 85\text{ }^\circ C$
Interrupt Pins - AC Parameters						
ALERT#, A_DET# Pin Blanking Time	$t_{BLANK}$		25		ms	
ALERT# Pin Interrupt Masking Time	$t_{MASK}$		5		ms	
<b>High-speed Data Switch</b>						
High-speed Data Switch - DC Parameters						

**Table 3.3 Electrical Specifications (continued)**

VDD = 4.5 V to 5.5 V, VS = 2.9 V to 5.5 V, V <sub>PULLUP</sub> = 3 V to 5.5 V, = -40 °C to all Typical values at VDD = VS = 5 V, T <sub>A</sub> = 27 °C unless otherwise noted.						
CHARACTERISTIC	SYMBOL	MIN	TYP	MAX	UNIT	CONDITIONS
Switch Leakage Current	I <sub>HSW_OFF</sub>		±0.5		μA	Switch open - DPIN to DPOUT, DMIN to DMOUT, or all four pins to ground. VDD ≤ VS.
Charger Resistance	R <sub>CHG</sub>	2			MΩ	DPOUT or DMOUT to VBUS or ground, see <a href="#">Figure 3.2</a> BC1.2 DCP charger emulation active
On Resistance	R <sub>ON_HSW</sub>		2		Ω	Switch closed, VDD = 5 V test current = 8 mA, test voltage = 0.4 V, see <a href="#">Figure 3.2</a>
On Resistance	R <sub>ON_HSW_1</sub>		5		Ω	Switch closed, VDD = 5 V, test current = 8 mA, test voltage = 3.0 V, see <a href="#">Figure 3.2</a>
Delta On Resistance	ΔR <sub>ON_HSW</sub>		±0.3		Ω	Switch closed, VDD = 5 V I <sub>TST</sub> = 8 mA, V <sub>TST</sub> = 0 to 1.5 V, see <a href="#">Figure 3.2</a>
High-speed Data Switch - AC Parameters						
DP, DM Capacitance to Ground	C <sub>HSW_ON</sub>		4		pF	Switch closed VDD = 5 V
DP, DM Capacitance to Ground	C <sub>HSW_OFF</sub>		2		pF	Switch open VDD = 5 V
Turn Off Time	t <sub>HSW_OFF</sub>		400		μs	Time from state control (EM_EN, M1, M2) switch on to switch off, R <sub>TERM</sub> = 50 Ω, C <sub>LOAD</sub> = 5 pF
Turn On Time	t <sub>HSW_ON</sub>		400		μs	Time from state control (EM_EN, M1, M2) switch off to switch on, R <sub>TERM</sub> = 50 Ω, C <sub>LOAD</sub> = 5 pF
Propagation Delay	t <sub>PD</sub>		0.25		ns	R <sub>TERM</sub> = 50 Ω, C <sub>LOAD</sub> = 5 pF
Propagation Delay Skew	Δt <sub>PD</sub>		25		ps	R <sub>TERM</sub> = 50 Ω, C <sub>LOAD</sub> = 5 pF
Rise/Fall Time	t <sub>F/R</sub>		10		ns	R <sub>TERM</sub> = 50 Ω, C <sub>LOAD</sub> = 5 pF
DP - DM Crosstalk	X <sub>TALK</sub>		-40		dB	R <sub>TERM</sub> = 50 Ω, C <sub>LOAD</sub> = 5 pF
Off Isolation	O <sub>IRR</sub>		-30		dB	R <sub>TERM</sub> = 50 Ω, C <sub>LOAD</sub> = 5 pF f = 240 MHz
-3dB Bandwidth	BW		1100		MHz	R <sub>TERM</sub> = 50 Ω, C <sub>LOAD</sub> = 1.5 pF V <sub>DPOUT</sub> = V <sub>DMOUT</sub> = 350 mV DC



**Table 3.3 Electrical Specifications (continued)**

VDD = 4.5 V to 5.5 V, VS = 2.9 V to 5.5 V, V <sub>PULLUP</sub> = 3 V to 5.5 V, = -40 °C to all Typical values at VDD = VS = 5 V, T <sub>A</sub> = 27 °C unless otherwise noted.						
CHARACTERISTIC	SYMBOL	MIN	TYP	MAX	UNIT	CONDITIONS
Total Jitter	t <sub>J</sub>		200		ps	R <sub>TERM</sub> = 50 Ω, C <sub>LOAD</sub> = 5 pF, rise time = fall time = 500 ps at 480 Mbps (PRBS = 2 <sup>15</sup> - 1)
Skew of Opposite Transitions of the Same Output	t <sub>SK(P)</sub>		20		ps	R <sub>TERM</sub> = 50 Ω, C <sub>LOAD</sub> = 5 pF
<b>Port Power Switch</b>						
Port Power Switch - DC Parameter						
Over-voltage Lockout	V <sub>S_OV</sub>		6		V	
On Resistance	R <sub>ON_PSW</sub>		55	65	mΩ	4.75 V < VS < 5.25 V
VS Leakage Current	I <sub>LEAK_VS</sub>		2.2	5	μA	Sleep state into VS pin
Back-voltage Protection Threshold	V <sub>BV_TH</sub>		150		mV	VBUS > VS VS > V <sub>S_UVLO</sub>
Back-drive Current	I <sub>BD_1</sub>		0	3	μA	VDD < V <sub>DD_TH</sub> , Any powered power pin to any unpowered power pin. Current out of unpowered pin.
	I <sub>BD_2</sub>		0	2	μA	VDD > V <sub>DD_TH</sub> , Any powered power pin to any unpowered power pin, except for VDD to VBUS in Detect power state and VS to VBUS in Active power state. Current out of unpowered pin.

**Table 3.3 Electrical Specifications (continued)**

VDD = 4.5 V to 5.5 V, VS = 2.9 V to 5.5 V, VPULLUP = 3 V to 5.5 V, = -40 °C to all Typical values at VDD = VS = 5 V, TA = 27 °C unless otherwise noted.						
CHARACTERISTIC	SYMBOL	MIN	TYP	MAX	UNIT	CONDITIONS
Selectable Current Limits	$I_{LIM1}$		480	500	mA	ILIM Resistor = 47 k $\Omega$ (500 mA setting)
	$I_{LIM2}$		850	900	mA	ILIM Resistor = 56 k $\Omega$ (900 mA setting)
	$I_{LIM3}$		950	1000	mA	ILIM Resistor = 68 k $\Omega$ (1000 mA setting)
	$I_{LIM4}$		1130	1200	mA	ILIM Resistor = 82 k $\Omega$ (1200 mA setting)
	$I_{LIM5}$		1400	1500	mA	ILIM Resistor = 100 k $\Omega$ (1500 mA setting)
	$I_{LIM6}$		1720	1800	mA	ILIM Resistor = 120 k $\Omega$ (1800 mA setting)
	$I_{LIM7}$		1910	2000	mA	ILIM Resistor = 150 k $\Omega$ (2000 mA setting)
	$I_{LIM8}$		2370	2500	mA	ILIM Resistor = VDD (2500 mA setting)
Pin Wake Time	$t_{PIN\_WAKE}$		3		ms	
Thermal Regulation Limit	$T_{REG}$		110		°C	Die Temperature at which current limit will be reduced
Thermal Regulation Hysteresis	$T_{REG\_HYST}$		10		°C	Hysteresis for $t_{REG}$ functionality. Temperature must drop by this value before ILIM value restored to normal operation
Thermal Shutdown Threshold	$T_{TSD}$		135		°C	Die Temperature at which port power switch will turn off
Thermal Shutdown Hysteresis	$T_{TSD\_HYST}$		35		°C	After shutdown due to $T_{TSD}$ being reached, die temperature drop required before port power switch can be turned on again
Auto-recovery Test Current	$I_{TEST}$		190		mA	Portable device attached, VBUS = 0 V, Die temp < $T_{TSD}$
Auto-recovery Test Voltage	$V_{TEST}$		750		mV	Portable device attached, VBUS = 0 V before application, Die temp < $T_{TSD}$
Discharge Impedance	$R_{DISCHARGE}$	100			$\Omega$	

**Table 3.3 Electrical Specifications (continued)**

VDD = 4.5 V to 5.5 V, VS = 2.9 V to 5.5 V, V <sub>PULLUP</sub> = 3 V to 5.5 V, = -40 °C to all Typical values at VDD = VS = 5 V, T <sub>A</sub> = 27 °C unless otherwise noted.						
CHARACTERISTIC	SYMBOL	MIN	TYP	MAX	UNIT	CONDITIONS
Port Power Switch - AC Parameters						
Turn On Delay	t <sub>ON_PSW</sub>		0.75		ms	PWR_EN active toggle to switch on time, VBUS discharge not active
Turn Off Time	t <sub>OFF_PSW_INA</sub>		0.75		ms	PWR_EN inactive toggle to switch off time C <sub>BUS</sub> = 120 μF
Turn Off Time	t <sub>OFF_PSW_ERR</sub>		1		ms	Over-current Error, VBUS Min Error, or Discharge Error to switch off C <sub>BUS</sub> = 120 μF
Turn Off Time	t <sub>OFF_PSW_ERR</sub>		100		ns	TSD or Back-drive Error to switch off C <sub>BUS</sub> = 120 μF
VBUS Output Rise Time	t <sub>R_BUS</sub>		1.1		ms	Measured from 10% to 90% of VBUS, C <sub>LOAD</sub> = 220 μF ILIM = 1.0 A
Soft Turn on Rate	ΔI <sub>BUS</sub> / Δt		100		mA / μs	
Temperature Update Time	t <sub>DC_TEMP</sub>		200		ms	
Short Circuit Response Time	t <sub>SHORT_LIM</sub>		1.5		μs	Time from detection of short to current limit applied. No C <sub>BUS</sub> applied
Short Circuit Detection Time	t <sub>SHORT</sub>		6		ms	Time from detection of short to port power switch disconnect and ALERT# pin assertion.
Latched Mode Cycle Time	t <sub>UL</sub>		7		ms	From PWR_EN edge transition from inactive to active to begin error recovery
Auto-recovery Mode Cycle Time	t <sub>CYCLE</sub>		25		ms	Time delay before error condition check
Auto-recovery Delay	t <sub>RST</sub>		20		ms	Portable device attached, VBUS must be ≥ V <sub>TEST</sub> after this time
Discharge Time	t <sub>DISCHARGE</sub>		200		ms	Amount of time discharge resistor applied

**Table 3.3 Electrical Specifications (continued)**

VDD = 4.5 V to 5.5 V, VS = 2.9 V to 5.5 V, V <sub>PULLUP</sub> = 3 V to 5.5 V, = -40 °C to all Typical values at VDD = VS = 5 V, T <sub>A</sub> = 27 °C unless otherwise noted.						
CHARACTERISTIC	SYMBOL	MIN	TYP	MAX	UNIT	CONDITIONS
Port Power Switch Operation With Trip Mode Current Limiting						
Region 2 Current Keep-out	I <sub>BUS_R2MIN</sub>			0.1	A	
Minimum VBUS Allowed at Output	V <sub>BUS_MIN</sub>	2.0			V	
Port Power Switch Operation With Constant Current Limiting (Variable Slope)						
Region 2 Current Keep-out	I <sub>BUS_R2MIN</sub>			1.5	A	
Minimum VBUS Allowed at Output	V <sub>BUS_MIN</sub>	2.0			V	
VBUS Bypass - DC						
On Resistance	R <sub>ON_BYP</sub>		50		Ω	
Leakage Current	I <sub>LEAK_BYP</sub>			3	μA	Switch off
Current Limit	I <sub>DET_CHG</sub> / I <sub>BUS_BYP</sub>		2		mA	VDD = 5 V and VBUS > 4.75 V
Attach / Removal Detection - DC						
Attach Detection Threshold	I <sub>DET_QUAL</sub>		800		μA	
Primary Removal Detection Threshold	I <sub>REM_QUAL_ACT</sub>		700		μA	Active power state
	I <sub>REM_QUAL_DET</sub>		800		μA	Detect power state (see <a href="#">Section 7.4</a> )
Attach / Removal Detection - AC						
Attach Detection Time	t <sub>DET_QUAL</sub>		100		ms	Time from Attach to A_DET# assert (UCS1001-4 only).
Removal Detection Time	t <sub>REM_QUAL</sub>		1000		ms	
Allowed Charge Time	t <sub>DET_CHARGE</sub>		800		ms	C <sub>BUS</sub> = 500 μF max
<b>Charger Emulation Profile</b>						
General Emulation - DC						
Charging Current Threshold	I <sub>BUS_CHG</sub>		156		mA	

**Table 3.3 Electrical Specifications (continued)**

VDD = 4.5 V to 5.5 V, VS = 2.9 V to 5.5 V, V <sub>PULLUP</sub> = 3 V to 5.5 V, = -40 °C to all Typical values at VDD = VS = 5 V, T <sub>A</sub> = 27 °C unless otherwise noted.						
CHARACTERISTIC	SYMBOL	MIN	TYP	MAX	UNIT	CONDITIONS
DP-DM Shunt Resistor Value	R <sub>D<sub>CP</sub>_RES</sub>			200	Ω	Connected between DPOUT and DMOUT 0 V < DPOUT = DMOUT ≤ 3 V
Voltage Output	SX_RXMAG_VOLT_BC	0.5			V	DMOUT 250 μA load
Pull-down Current	SX_PUPD_ACC_BC	50			μA	DPOUT or DMOUT = 0.15 V Compliance voltage
General Emulation - AC						
Emulation Reset Time	t <sub>EM_RESET</sub>		50		ms	

**Note 3.2** For split supply systems using the Attach Detection feature, VS must not exceed VDD + 150 mV.

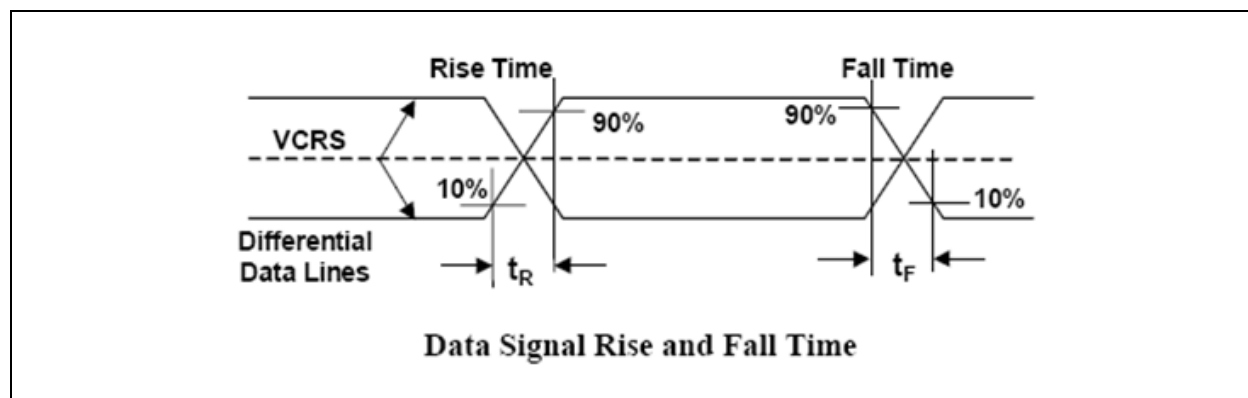

**Figure 3.1 USB Rise Time / Fall Time Measurement**

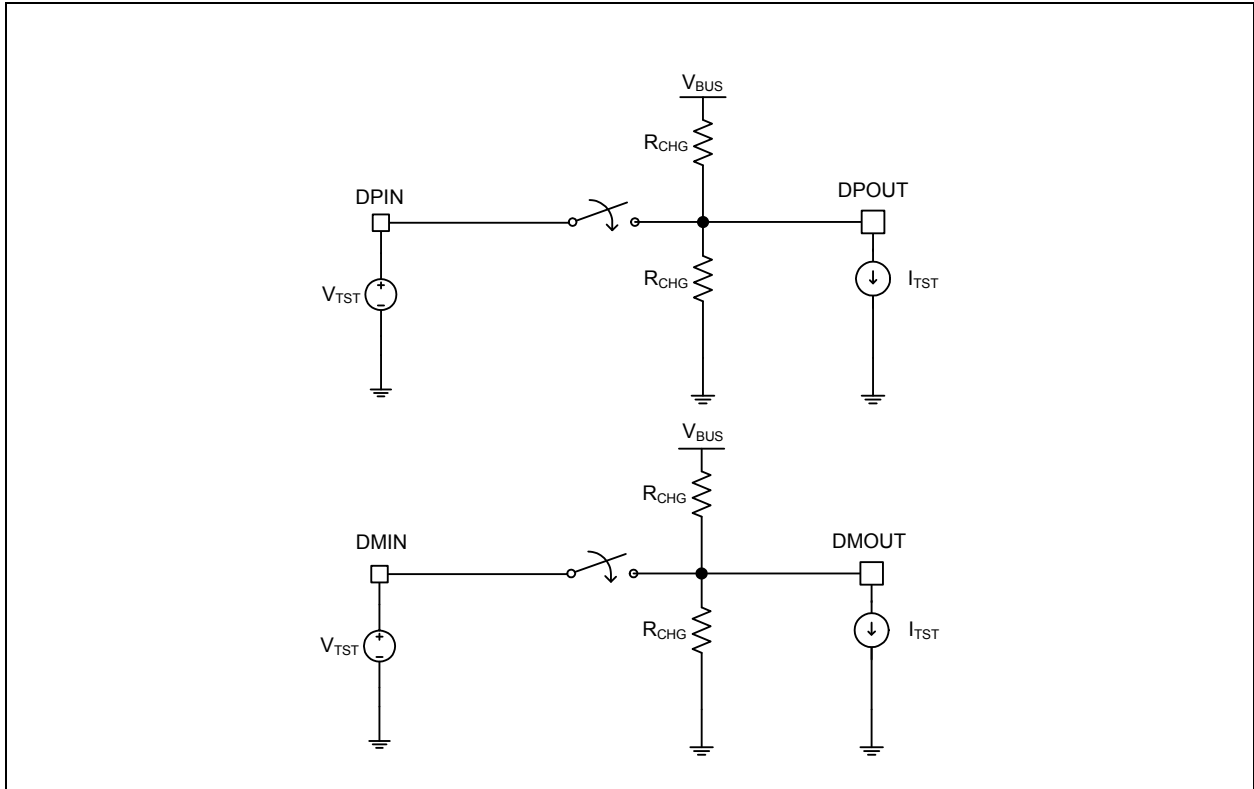

Figure 3.2 Description of DC Terms

## 3.1 ESD & Transient Performance

**APPLICATION NOTE:** Depending on the level of ESD protection required by the application, external protection devices may be required. The datasheet ESD levels were reached using external devices and standard USB-A connectors; refer to the EVB schematic and reference design for details.

**Table 3.4 ESD Ratings**

ESD SPEC	RATING OR VALUE
EN / IEC61000-4-2 (DPOUT, DMOUT pins) air gap, Operational Classification B (see <a href="#">Note 3.3</a> )	Level4(15kV)
EN / IEC61000-4-2 (DPOUT, DMOUT pins) direct contact, Operational Classification B (see <a href="#">Note 3.3</a> )	Level4(8 kV)
EN / IEC61000-4-2 (VBUS, GND pins) air gap, Operational Classification A (see <a href="#">Note 3.4</a> )	Level4(15 kV)
EN / IEC61000-4-2 (VBUS, GND pins) direct contact, Operational Classification A (see <a href="#">Note 3.4</a> )	Level4(8 kV)

**Note 3.3** Operational Classification B indicates that during and immediately after an ESD event, anomalous behavior may occur; however, it is non-damaging and the device is self-recovering. All IEC testing is performed using an SMSC evaluation board.

**Note 3.4** Operational Classification A indicates that during and immediately after an ESD event no anomalous behavior will occur. All IEC testing is performed using an SMSC evaluation board.

### 3.1.1 Human Body Model (HBM) Performance

HBM testing verifies the ability to withstand ESD strikes like those that occur during handling and manufacturing and is done without power applied to the IC. To pass the test, the device must have no change in operation or performance due to the event.

### 3.1.2 Charged Device Model (CDM) Performance

CDM testing verifies the ability to withstand ESD strikes like those that occur during handling and assembly with pick and place style machinery and is done without power applied to the IC. To pass the test, the device must have no change in operation or performance due to the event.

### 3.1.3 IEC61000-4-2 Performance

The IEC61000-4-2 ESD specification is an international standard that addresses system-level immunity to ESD strikes while the end equipment is operational. These tests are performed while the device is powered.





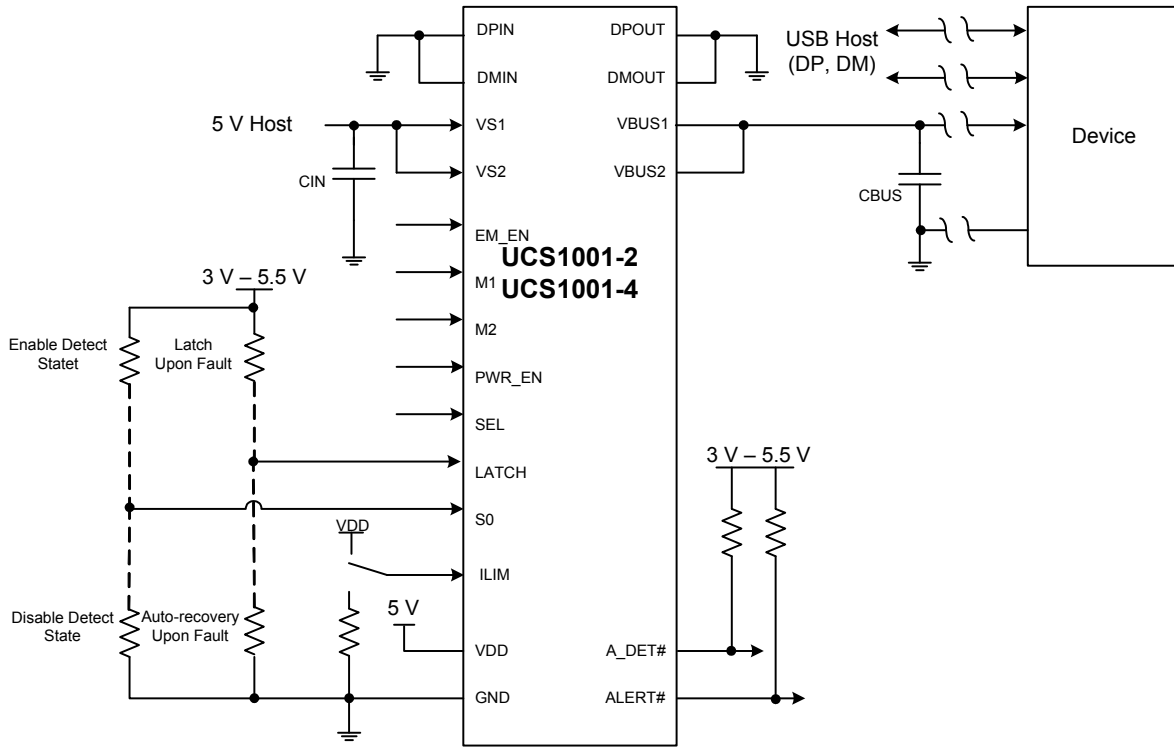

**Figure 4.2 UCS1001-4 System Configuration (No Charger Emulation)**

Figure 4.3 shows a system configuration in which the UCS1001-3 provides a port power switch, low power Attach Detection, charger emulation (with no USB host), and charging active signaling. Figure 4.4 shows a system configuration in which the UCS1001-4 provides a port power switch, low power Attach Detection, charger emulation (with no USB host), and portable device Attach Detection signaling. These configurations are useful for wall adapter type applications.



Figure 4.3 UCS1001-3 System Configuration (No USB Host, with Charger Emulation)



**Figure 4.4 UCS1001-4 System Configuration (No USB Host, with Charger Emulation)**

UCS1001-3 and UCS1001-4 references designs are available; contact your SMSC representative.

## 4.1 UCS1001 Power States

The UCS1001 has the following power states.

- **Off** - This power state is entered when the voltage at the VDD pin voltage is  $< V_{DD\_TH}$ . In this state the device is considered “off”. The UCS1001 will not retain its digital states. The port power switch, bypass switch, and the high-speed data switches will be off. See [Section 4.1.1, "Off State Operation"](#).
- **Sleep** - This is the lowest power state available. While in this state, the UCS1001 will respond to changes in emulation controls. The high-speed switch and all other functionality will be disabled. See [Section 4.1.2, "Sleep State Operation"](#).
- **Detect** - This is a lower current power state. In this state, the device is actively looking for a portable device to be attached. The high-speed switch is disabled. See [Section 4.1.3, "Detect State Operation"](#).
- **Error** - This power state is entered when a fault condition exists. See [Section 4.1.5, "Error State Operation"](#).
- **Active** - This power state provides full functionality. While in this state, operations include activation of the port power switch, USB data line handshaking / charger emulation, current limiting. See [Section 4.1.4, "Active State Operation"](#).

Table 4.1 shows the settings for the various power states, except Off and Error. If  $V_{DD} < V_{DD\_TH}$ , the UCS1001 is in the Off state. To determine the mode of operation in the Active state, see Table 9.1, "Active Mode Selection". For more information about configuring the UCS1001 to create single or dual mode charger solutions, see SMSC application note24.20"Using the as a Single or Dual Mode Charger."

**APPLICATION NOTE:** Using configurations not listed in Table 4.1 is not recommended and may produce undesirable results.

**Table 4.1 Power States Control Settings**

POWER STATE	VS	PWR_EN	S0	M1, M2, EM_EN	PORTABLE DEVICE ATTACHED	BEHAVIOR
Sleep	X	disabled	0	Not set to Data Pass-through. See Note 4.1.	X	All switches disabled. VBUS will be near ground potential.
	X	enabled	0	All = 0b	X	
Detect (see Chapter 7, Detect State)	X	disabled	1	X	X	High-speed switch disabled. Port power switch disabled. Host-controlled transition to Active state (see Section 4.1.3.2, "Host-Controlled Transition from Detect to Active").
	$< V_{S\_UVLO}$	enabled	1	All $\neq$ 0b	X	
	$> V_{S\_UVLO}$	enabled	1	All $\neq$ 0b	No	High-speed switch disabled. Automatic transition to Active state when conditions met (see Section 4.1.3.1, "Automatic Transition from Detect to Active").
Active (see Chapter 9, Active State)	$> V_{S\_UVLO}$	enabled	0	All $\neq$ 0b	X	High-speed switch enabled / disabled based on mode. Port power switch is on at all times. Attach and Removal Detection disabled. See Note 4.2.
	$> V_{S\_UVLO}$	enabled	1	All $\neq$ 0b	Yes	Port power switch is on. Removal Detection enabled.

**Note 4.1** In order to transition from Active state Data Pass-through mode into Sleep with these settings, change the M1, M2, and EM\_EN pins before changing the PWR\_EN pin. See Section 9.4, "Data Pass-through (No Charger Emulation)".

**Note 4.2** If  $S0=0'$  and a portable device is not attached in DCE Cycle mode, the UCS1001 will be cycling through charger emulation profiles. There is no guarantee which charger emulation profile will be applied first when a portable device attaches.

#### 4.1.1 Off State Operation

The device will be in the off state if  $V_{DD}$  is less than  $V_{DD\_TH}$ . When the UCS1001 is in the Off state, it will do nothing, and all circuitry will be disabled.

## 4.1.2 Sleep State Operation

When the UCS1001 is in the Sleep state, the device will be in its lowest power state. The high-speed switch, bypass switch, and the port power switch will be disabled. The Attach and Removal Detection feature will be disabled. VBUS will be near ground potential. The ALERT# pin will not be asserted. If asserted prior to entering the Sleep state, the ALERT# pin will be released. The A\_DET# pin will be released.

Figure 4.5 shows timing diagrams for waking the UCS1001.



Figure 4.5 Wake Timing

## 4.1.3 Detect State Operation

When the UCS1001 is in the Detect state, the port power switch will be disabled. The high-speed switch is also disabled. The VBUS output will be connected to the VDD voltage by a secondary bypass switch (see Chapter 7, Detect State).

There is one **non-recommended** configuration which places the UCS1001 in the Detect state, but VBUS will not be discharged and a portable device attachment will not be detected. For the recommended configurations, see Table 4.1, "Power States Control Settings".

- **NOT RECOMMENDED:** PWR\_EN is enabled, S0 = '1', and M1, M2, and EM\_EN are all '0'.

There are two methods for transitioning from the Detect state to the Active state: automatic and host-controlled.

### 4.1.3.1 Automatic Transition from Detect to Active

For the Detect state, set S0 to '1', enable PWR\_EN, set the EM\_EN, M1, and M2 controls to the desired Active mode (Table 9.1, "Active Mode Selection"), and supply VS > VS\_UVLO. When a portable device is attached and an Attach Detection event occurs, the UCS1001 will automatically transition to the Active state and operate according to the selected Active mode.

#### 4.1.3.2 Host-Controlled Transition from Detect to Active

For the Detect state, set S0 to '1', set the EM\_EN, M1, and M2 controls to the desired Active mode ([Table 9.1, "Active Mode Selection"](#)), and configure one of the following: 1) disable PWR\_EN and supply VS, or 2) enable PWR\_EN and don't supply VS. When a portable device is attached and an Attach Detection event occurs, the host must respond to transition to the Active state. Depending on the control settings in the Detect state, this could entail 1) enabling PWR\_EN or 2) supplying VS above the threshold.

**APPLICATION NOTE:** If S0 is '1', PWR\_EN is enabled, and VS is not present, the A\_DET# pin will cycle if the current draw exceeds the current capacity of the bypass switch.

#### 4.1.3.3 State Change from Detect to Active

When conditions cause the UCS1001 to transition from the Detect state to the Active state, the following occurs:

1. The Attach Detection feature will be disabled; the Removal Detection feature remains enabled, unless S0 is changed to '0'.
2. The bypass switch will be turned off.
3. The discharge switch will be turned on.
4. The port power switch will be turned on.

#### 4.1.4 Active State Operation

Every time that the UCS1001 enters the Active state and the port power switch is closed, it will enter the mode as instructed by the host controller (see [Chapter 9, Active State](#)). The UCS1001 cannot be in the Active state (and therefore, the port power switch cannot be turned on) if any of the following conditions exist:

1.  $VS < V_{S\_UVLO}$ .
2. PWR\_EN is disabled.
3. M1, M2, and EM\_EN are all set to '0'.
4. S0 is set to '1' and an Attach Detection event has not occurred.

## 4.1.5 Error State Operation

The UCS1001 will enter the Error state from the Active state when any of the following events are detected:

1. The maximum allowable internal die temperature ( $T_{TSD}$ ) has been exceeded (see [Section 6.3.1.2](#)).
2. An over-current condition has been detected (see [Section 6.2.1](#)).
3. An under-voltage condition on VBUS has been detected (see [Section 4.2.5](#)).
4. A back-drive condition has been detected (see [Section 4.2.3](#)).
5. A discharge error has been detected (see [Section 6.4](#)).
6. An over-voltage condition on the VS pins.

The UCS1001 will enter the Error state from the Detect state when a back-drive condition has been detected or when the maximum allowable internal die temperature has been exceeded.

The UCS1001 will enter the Error state from the Sleep state when a back-drive condition has been detected.

When the UCS1001 enters the Error state, the port power switch, the VBUS bypass switch, the high-speed switch are turned off, and the ALERT# pin is asserted. They will remain off while in this power state. The UCS1001 will leave this state as determined by the fault handling selection (see [Section 6.5, "Fault Handling Mechanism"](#)).

When using the Latch fault handler and the user has re-activated the device by or toggling the PWR\_EN control, the UCS1001 will check that all of the error conditions have been removed. If using Auto-recovery fault handler, after the  $t_{CYCLE}$  time period, the UCS1001 will check that all of the error conditions have been removed.

If all of the error conditions have been removed, the UCS1001 will return to the Active state or Detect state, as applicable. Returning to the Active state will cause the UCS1001 to restart the selected mode (see [Section 9.2, "Active Mode Selection"](#)).

If the device is in the Error state and a Removal Detection event occurs, it will check the error conditions and then return to the power state defined by the PWR\_EN, M1, M2, EM\_EN, and S0 controls.

## 4.2 Supply Voltages

### 4.2.1 VDD Supply Voltage

The UCS1001 requires 4.5 V to 5.5 V present on the VDD pin for core device functionality.

### 4.2.2 VS Source Voltage

VS can be a separate supply and can be greater than VDD to accommodate high current applications in which current path resistances result in unacceptable voltage drops that may prevent optimal charging of some portable devices.



### 4.2.3 Back-voltage Detection

Whenever the following conditions are true, the port power switch will be disabled, the VBUS bypass switch will be disabled, the high-speed data switch will be disabled, and a Back-voltage event will be flagged. This will cause the UCS1001 to enter the Error power state (see [Section 4.1.5, "Error State Operation"](#)).

1. The VBUS voltage exceeds the VS voltage by  $V_{BV\_TH}$  and the port power switch is closed. The port power switch will be opened immediately. If the condition lasts for longer than  $t_{MASK}$ , then the UCS1001 will enter the Error state. Otherwise, the port power switch will be turned on as soon as the condition is removed.
2. The VBUS voltage exceeds the VDD voltage by  $V_{BV\_TH}$  and the VBUS bypass switch is closed. The bypass switch will be opened immediately. If the condition lasts for longer than  $t_{MASK}$ , then the UCS1001 will enter the Error state. Otherwise, the bypass switch will be turned on as soon as the condition is removed.

### 4.2.4 Back-drive Current Protection

If a portable device is attached that is self-powered, it may drive the VBUS port to its power supply voltage level; however, the UCS1001 is designed such that leakage current from the VBUS pins to the VDD or VS pins shall not exceed  $I_{BD\_1}$  (if the VDD voltage is zero) or  $I_{BD\_2}$  (if the VDD voltage exceeds  $V_{DD\_TH}$ ).

### 4.2.5 Under-voltage Lockout on VS

The UCS1001 requires a minimum voltage ( $V_{S\_UVLO}$ ) be present on the VS pin for Active power state.

### 4.2.6 Over-voltage Detection and Lockout on VS

The UCS1001 port power switch will be disabled if the voltage on the VS pin exceeds a voltage ( $V_{S\_OV}$ ) for longer than the specified time ( $t_{MASK}$ ). This will cause the device to enter the Error state.

## 4.3 Discrete Input Pins

**APPLICATION NOTE:** If it is necessary to connect any of the control pins except the ILIM or SEL pins via a resistor to VDD or GND, the resistor value should not exceed 100 k $\Omega$  in order to meet the VIH and VIL specifications.

### 4.3.1 ILIM Input

The ILIM input determines the initial ILIM setting, as shown in [Table 6.1, "UCS1001 ILIM Selection"](#).

### 4.3.2 SEL Input

The SEL pin selects the polarity of the PWR\_EN control. If the SEL pin is high, the PWR\_EN control is active high enable. If the SEL pin is low, the PWR\_EN control is active low enable. This pin state is latched upon device power-up and further changes will have no effect on the PWR\_EN control polarity.

**APPLICATION NOTE:** If it is necessary to connect the SEL pin to ground via a resistor, a value less than 33k $\Omega$  must be used. If it is necessary to connect the SEL pin to VDD via a resistor, the pull-up resistor may be any value up to 100 k $\Omega$ .

### 4.3.3 M1, M2, and EM\_EN Inputs

The M1, M2, and EM\_EN input controls determine the Active mode and affect the power state (see [Table 4.1, "Power States Control Settings"](#) and [Table 9.1, "Active Mode Selection"](#)). When these controls are all set to '0' and PWR\_EN is enabled, the UCS1001 Attach and Removal Detection feature is disabled.

### 4.3.4 PWR\_EN Input

The PWR\_EN control enables the port power switch to be turned on if conditions are met and affects the power state (see [Table 4.1, "Power States Control Settings"](#)). The port power switch cannot be closed if PWR\_EN is disabled. However, if PWR\_EN is enabled, the port power switch is not necessarily closed (see [Section 4.1.4, "Active State Operation"](#)). Polarity is controlled by the SEL pin.

### 4.3.5 Latch Input

The Latch input control determines the behavior of the fault handling mechanism (see [Section 6.5, "Fault Handling Mechanism"](#)).

### 4.3.6 S0 Input

The S0 control enables the Attach and Removal Detection feature and affects the power state (see [Table 4.1, "Power States Control Settings"](#)). When S0 is set to '1', an Attach Detection event must occur before the port power switch can be turned on. When S0 is set to '0', the Attach and Removal Detection feature is not enabled.

## 4.4 Discrete Output Pins

### 4.4.1 ALERT# and A\_DET# Output Pins

The ALERT# pin is an active low open-drain interrupt to the host controller. The ALERT# pin is asserted when an error occurs (see [Section 4.1.5, "Error State Operation"](#)). The ALERT# pin is released when all conditions have been removed.

The CHRG# pin (UCS1001-3) provides an active low open-drain output indication that charging of an attached device is active. It will remain asserted until this condition no longer exists and then will be automatically released.

The A\_DET# pin (UCS1001-4) provides an active low open-drain output indication that a valid Attach Detection event has occurred. It will remain asserted until the UCS1001 is placed into the Sleep state or a Removal Detection event occurs. For wake on USB, the A\_DET# pin assertion can be utilized by the system. If the S0 control is '0' and the UCS1001 is in the Active state, the A\_DET# pin will be asserted regardless if a portable device is attached or not. If S0 is '1', PWR\_EN is enabled, and VS is not present, the A\_DET# pin will cycle if the current draw exceeds the current capacity of the bypass switch.

### 4.4.2 Interrupt Blanking

The ALERT#,CHRG#(UCS1001-3), and A\_DET# (UCS1001-4)pins will not be asserted for a specified time (up to  $t_{BLANK}$ ) after power-up. Additionally, an error condition (except for the thermal shutdown) must be present for longer than a specified time ( $t_{MASK}$ ) before the ALERT# pin is asserted.

## Chapter 5 USB High-speed Data Switch

### 5.1 USB High-speed Data Switch

The UCS1001 contains a series USB 2.0 compliant high-speed switch between the DPIN and DMIN pins and between the DPOUT and DMOOUT pins. This switch is designed for high-speed, low latency functionality to allow USB 2.0 full-speed and high-speed communications with minimal interference.

Nominally, the switch is closed in the Active state, allowing uninterrupted USB communications between the upstream host and the portable device. The switch is opened when:

1. The UCS1001 is actively emulating using any of the charger emulation profiles except CDP.
2. The UCS1001 is operating as a dedicated charger.
3. The UCS1001 is in the Detect state or in the Sleep state.

**APPLICATION NOTE:** If the VDD voltage is less than  $V_{DD\_TH}$ , the high-speed data switch will be disabled and opened.

#### 5.1.1 USB-IF High-speed Compliance

The USB data switch will not significantly degrade the signal integrity through the device DP / DM pins with USB high-speed communications.

## Chapter 6 USB Port Power Switch

### 6.1 USB Port Power Switch

To assure compliance to various charging specifications, the UCS1001 contains a USB port power switch that supports two current limiting modes: trip and constant current (variable slope). The current limit (ILIM) is pin selectable. The switch also includes soft start circuitry and a separate short circuit current limit.

The port power switch is on in the Active state (except when VBUS is discharging).

### 6.2 Current Limiting

#### 6.2.1 Current Limit Setting

The UCS1001 hardware set current limit, ILIM, can be one of eight values (see [Table 6.1](#)). This resistor value is read once upon UCS1001 power-up.

**APPLICATION NOTE:** If it is necessary to connect the ILIM pin to VDD via a pull-up resistor, it is recommended that this resistor value not exceed 100 k $\Omega$ .

**APPLICATION NOTE:** ILIM pin pull-down resistors with values less than 33 k $\Omega$  will cause unexpected behavior.

**Table 6.1 UCS1001 ILIM Selection**

ILIM RESISTOR ( $\pm 5\%$ )	ILIM SETTING
47 k $\Omega$ pull-down	500 mA
56 k $\Omega$ pull-down	900 mA
68 k $\Omega$ pull-down	1000 mA
82 k $\Omega$ pull-down	1200 mA
100 k $\Omega$ pull-down	1500 mA
120 k $\Omega$ pull-down	1800 mA
150 k $\Omega$ pull-down	2000 mA
VDD (If a pull-up resistor is used, its value must not exceed 100 k $\Omega$ .)	2500 mA

#### 6.2.2 Short Circuit Output Current Limiting

Short circuit current limiting occurs when the output current is above the selectable current limit ( $I_{LIMx}$ ). This event will be detected and the current will immediately be limited (within  $t_{SHORT\_LIM}$  time). If the condition remains, the port power switch will flag an Error condition and enter the Error state (see [Section 4.1.5, "Error State Operation"](#)).

### 6.2.3 Soft Start

When the PWR\_EN control changes states to enable the port power switch, or an Attach Detection event occurs in the Detect power state and the PWR\_EN control is already enabled, the UCS1001 invokes a soft start routine for the duration of the VBUS rise time ( $t_{R\_BUS}$ ). This soft start routine will limit current flow from VS into VBUS while it is active. This circuitry will prevent current spikes due to a step in the portable device current draw.

In the case when a portable device is attached while the PWR\_EN pin is already enabled, if the bus current exceeds ILIM, the UCS1001 current limiter will respond within a specified time ( $t_{SHORT\_LIM}$ ) and will operate normally at this point. The  $C_{BUS}$  capacitor will deliver the extra current, if any, as required by the load change.

### 6.2.4 Current Limiting Modes

The UCS1001 current limiting has two modes: trip and constant current (variable slope). Either mode functions at all times when the port power switch is closed. The current limiting mode used depends on the Active state mode (see [Section 9.9, "Current Limit Mode Associations"](#)). When operating in the Detect power state (see [Section 4.1.3](#)), the current capacity at VBUS is limited to  $I_{BUS\_BYP}$  as described in [Section 7.2, "VBUS Bypass Switch"](#).

#### 6.2.4.1 Trip Mode

When using trip current limiting, the UCS1001 USB port power switch functions as a low resistance switch and rapidly turns off if the current limit is exceeded. While operating using trip current limiting, the VBUS output voltage will be held relatively constant (equal to the VS voltage minus the  $R_{ON} * I_{BUS}$  current) for all current values up to the ILIM.

If the current drawn by a portable device exceeds ILIM, the following occurs:

1. The port power switch will be turned off (trip action).
2. The UCS1001 will enter the Error state and assert the ALERT# pin.
3. The fault handling circuitry will then determine subsequent actions.

Trip current limiting is used when the UCS1001 is in Data Pass-through and Dedicated Charger Emulation Cycle (except when the BC1.2 DCP charger emulation profile is accepted), and when there's no handshake.

**APPLICATION NOTE:** To avoid cycling in trip mode, set ILIM higher than the highest expected portable device current draw.

[Figure 6.1](#) shows operation of current limits in trip mode with the shaded area representing the USB 2.0 specified VBUS range. Dashed lines indicate the port power switch output will go to zero (e.g., trip) when ILIM is exceeded. Note that operation at all possible values of ILIM are shown in [Figure 6.1](#) for illustrative purposes only; in actual operation only one ILIM can be active at any time.

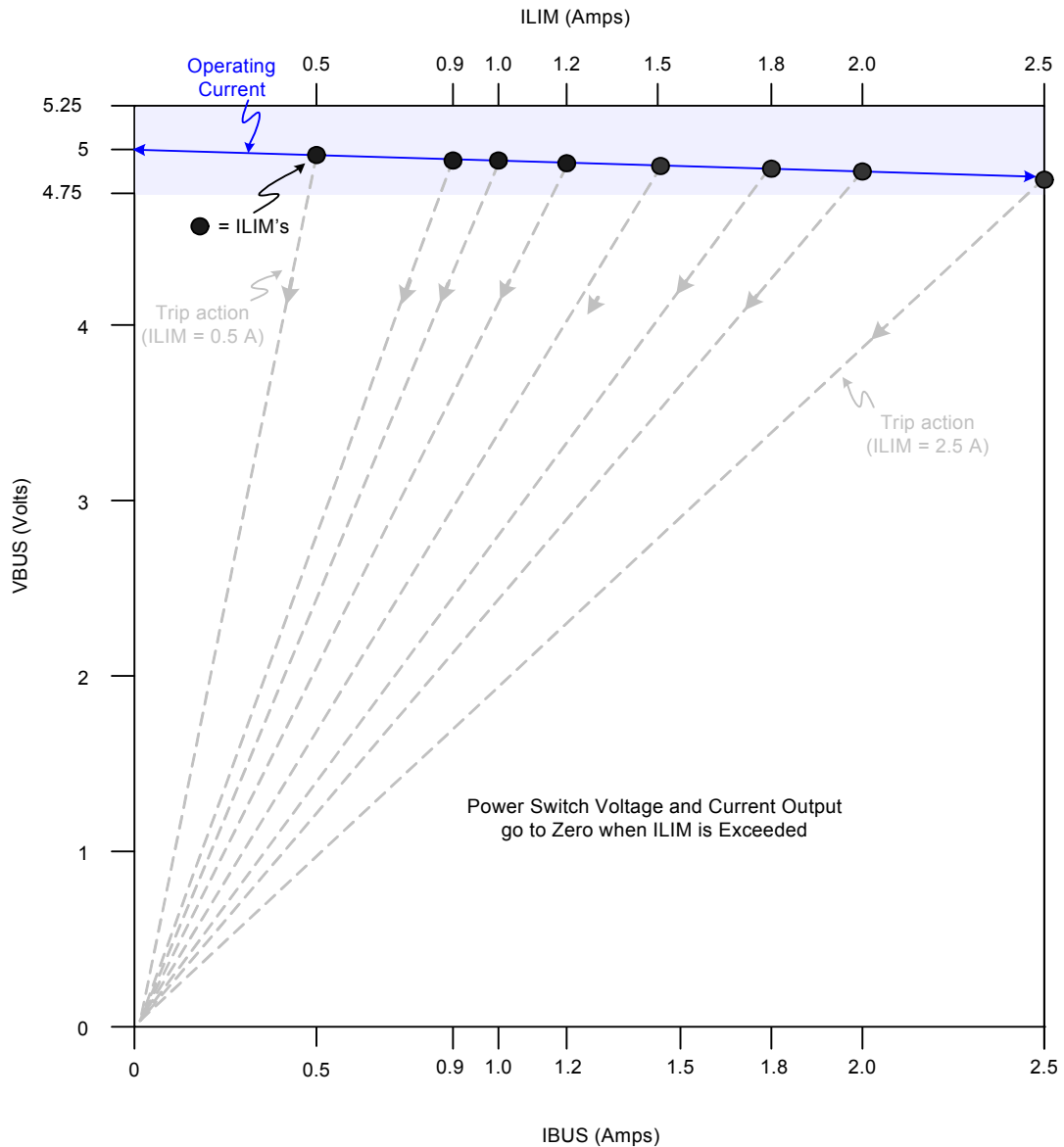

**Figure 6.1 Trip Current Limiting Operation**

**6.2.4.2 Constant Current Limiting (Variable Slope)**

Constant current limiting is used when a portable device handshakes using the BC1.2 DCP charger emulation profile and the current drawn is greater than ILIM (and  $ILIM \leq 1.5$  A). It's also used in BC1.2 CDP mode and during the DCE Cycle when a charger emulation profile is being applied.

In CC mode, the port power switch allows the attached portable device to reduce VBUS output voltage to less than the input VS voltage while maintaining current delivery. The V/I slope depends on the user set ILIM value. This slope is held constant for a given ILIM value.

Figure 6.2 shows operation of current limits while using CC mode. Unlike trip mode, once IBUS current exceeds ILIM, operation continues at a reduced voltage and increased current. Note that the shaded area representing the USB 2.0 specified VBUS range is now restricted to an upper current limit of  $I_{BUS\_R2MIN}$ . Note that the UCS1001 will heat up along each load line as voltage decreases. If the internal temperature exceeds the  $T_{REG}$  or  $T_{TSD}$  thresholds, the port power switch will open. Also note that when the VBUS voltage is brought low enough, the port power switch will open.



Figure 6.2 Constant Current Limiting (Variable Slope) Operation

## 6.3 Thermal Management and Voltage Protection

### 6.3.1 Thermal Management

The UCS1001 utilizes two-stage internal thermal management. The first is named dynamic thermal management and the second is a fixed thermal shutdown.

### 6.3.1.1 Dynamic Thermal Management

For the first stage (active in both current limiting modes), referred to as dynamic thermal management, the UCS1001 automatically adjusts port power switch limits and modes to lower power dissipation when the thermal regulation temperature value is approached, as described below.

If the internal temperature exceeds the  $T_{REG}$  value, the port power switch is opened, the current limit (ILIM) will be lowered by one step and a timer is started ( $t_{DC\_TEMP}$ ). When this timer expires, the port power switch is closed and the internal temperature will be checked again. If it remains above the  $T_{REG}$  threshold, the UCS1001 will repeat this cycle (open port power switch and reduce the ILIM setting by one step) until ILIM reaches its minimum value.

**APPLICATION NOTE:** If the temperature exceeds the TREG threshold while operating in the DCE Cycle mode after a charger emulation profile has been accepted, the profile will be removed. The UCS1001 will not restart the DCE Cycle until one of the control inputs changes states to restart emulation.

**APPLICATION NOTE:** The UCS1001 will not actively discharge VBUS as a result of the temperature exceeding TREG; however, any load current provided by a portable device or other load will cause VBUS to be discharged when the port power switch is opened, possibly resulting in an attached portable device resetting.

If the UCS1001 is operating using constant current limiting (variable slope) and the ILIM setting has been reduced to its minimum set point and the temperature is still above  $T_{REG}$ , the UCS1001 will switch to operating using trip current limiting. This will be done by reducing the  $I_{BUS\_R2MIN}$  setting to 100 mA and restoring the ILIM setting to the value immediately below the programmed setting (e.g., if the programmed ILIM is 1.8 A, the value will be set to 1.5 A). If the temperature continues to remain above  $T_{REG}$ , the UCS1001 will continue this cycle (open the port power switch and reduce the ILIM setting by one step).

If the UCS1001 internal temperature drops below  $T_{REG} - T_{REG\_HYST}$ , the UCS1001 will take action based on the following:

1. If the current limit mode changed from CC mode to trip mode, then a timer is started. When this timer expires, the UCS1001 will reset the port power switch operation to its original configuration allowing it to operate using constant current limiting (variable slope).
2. If the current limit mode did not change from CC mode to trip mode, or was already operating in trip mode, the UCS1001 will reset the port power switch operation to its original configuration.

If the UCS1001 is operating using trip current limiting and the ILIM setting has been reduced to its minimum set point and the temperature is above  $T_{REG}$ , the port power switch will be closed and the current limit will be held at its minimum setting until the temperature drops below  $T_{REG} - T_{REG\_HYST}$ .

### 6.3.1.2 Thermal Shutdown

The second stage thermal management consists of a hardware implemented thermal shutdown corresponding to the maximum allowable internal die temperature ( $T_{TSD}$ ). If the internal temperature exceeds this value, the port power switch will immediately be turned off until the temperature is below  $T_{TSD} - T_{TSD\_HYST}$ .



## 6.4 VBUS Discharge

The UCS1001 will discharge  $V_{BUS}$  through an internal 100  $\Omega$  resistor when at least one of the following conditions occurs:

- The PWR\_EN control is disabled (triggered on the inactive edge of the PWR\_EN control).
- A portable device Removal Detection event is flagged.
- The VS voltage drops below a specified threshold ( $V_{S\_UVLO}$ ) that causes the port power switch to be disabled.
- When commanded into the Sleep power state via the EM\_EN, M1, and M2 controls.
- Before each charger emulation profile is applied.
- Upon recovery from the Error state.
- Any time that the port power switch is activated after the VBUS bypass switch has been on (i.e., whenever VBUS voltage transitions from being driven from VDD to being driven from VS, such as going from Detect to Active power state).
- Any time that the VBUS bypass switch is activated after the port power switch has been on (i.e., going from Active to Detect power state).

When the VBUS discharge circuitry is activated, the UCS1001 will confirm that VBUS was discharged. If the VBUS voltage is not below the  $V_{TEST}$  level, a discharge error will be flagged and the UCS1001 will enter the Error state.

## 6.5 Fault Handling Mechanism

The UCS1001 has two modes for handling faults: Latch (latch-upon-fault) or Auto-recovery (automatically attempt to restore the Active power state after a fault occurs). The fault handling mechanism used depends on the state of the LATCH pin. Faults include over-current, over-voltage (on VS), under-voltage (on VBUS), back-voltage (VBUS to VS or VBUS to VDD), discharge error, and maximum allowable internal die temperature ( $T_{TSD}$ ) exceeded (see [Section 4.1.5, "Error State Operation"](#)).

### 6.5.1 Auto-recovery Fault Handling

When the LATCH pin is low, auto-recovery fault handling is used. When an error condition is detected, the UCS1001 will immediately enter the Error state and assert the ALERT# pin (see [Section 4.1.5](#)). Independently from the host controller, the UCS1001 will wait a preset time ( $t_{CYCLE}$ ), check error conditions ( $t_{TST}$ ), and restore Active operation if the error condition(s) no longer exist. The ALERT# pin will be released.

### 6.5.2 Latched Fault Handling

When the LATCH pin is high, latch fault handling is used. When an error condition is detected, the UCS1001 will enter the Error power state and assert the ALERT# pin. Upon command from the host controller (by toggling the PWR\_EN from enabled to disabled), the UCS1001 will check error conditions once and restore Active operation if error conditions no longer exist. If an error condition still exists, the host controller is required to issue the command again to check error conditions.

## Chapter 7 Detect State

### 7.1 Device Attach / Removal Detection

The UCS1001 can detect the attachment and removal of a portable device on the USB port. Attach and Removal Detection does not perform any charger emulation or qualification of the device. The high-speed switch is “off” during the Detect power state.

### 7.2 VBUS Bypass Switch

In the Detect state, VDD is the voltage source; in the Active state, VS is the voltage source. The bypass switch and the port power switch are never both on at the same time.

While the VBUS bypass switch is active, the current available to a portable device will be limited, and the Attach Detection feature is active.

### 7.3 Attach Detection

The Attach Detection feature is only active in the Detect power state. When active, this feature constantly monitors for portable device attachment. When an Attach Detection event occurs, the UCS1001-4 will assert the A\_DET# pin low. The UCS1001-3 internally flags the event.

Once an Attach Detection event occurs, the UCS1001 will wait for the PWR\_EN control to be enabled (if not already). When PWR\_EN is enabled and VS is above the threshold, the UCS1001 will activate the USB port power switch and operate in the selected Active mode (see [Chapter 9, Active State](#)).

### 7.4 Removal Detection

When a Removal Detection event is flagged, the following will be done:

1. Disable the port power switch and the bypass switch.
2. De-assert the A\_DET# pin(UCS1001-4 only).
3. Enable an internal discharging device that will discharge the VBUS line.
4. Once the VBUS pin has been discharged, the device will return to the Detect state regardless of the PWR\_EN control state.

## Chapter 8 Active State

### 8.1 Active State Overview

The UCS1001 has the following modes of operation in the Active state: Data Pass-through, BC1.2 DCP, BC1.2 SDP, BC1.2 CDP, and Dedicated Charger Emulation Cycle. The current limiting mode depends on the Active mode behavior (see [Table 8.2, "Current Limit Mode Options"](#)).

### 8.2 Active Mode Selection

The Active mode selection is controlled by three controls: EM\_EN, M1, and M2, as shown in [Table 8.1](#).

**Table 8.1 Active Mode Selection**

#	M1	M2	EM_EN	ACTIVE MODE
1	0	0	1	Dedicated Charger Emulation Cycle
2	0	1	0	Data Pass-through
3	0	1	1	BC1.2 DCP
4	1	0	0	BC1.2 SDP - See <a href="#">Note 8.1</a>
5	1	0	1	Dedicated Charger Emulation Cycle
6	1	1	0	Data Pass-through
7	1	1	1	BC1.2 CDP

**Note 8.1** BC1.2 SDP behaves the same as the Data Pass-through mode with the exception that it is preceded by a VBUS discharge when the mode is entered per the BC1.2 specification.

### 8.3 BC1.2 Detection Renegotiation

The BC1.2 specification allows a charger to act as an SDP, CDP, or DCP and to change between these roles. To force an attached portable device to repeat the charging detection procedure, VBUS must be cycled. In compliance with this specification, the UCS1001 automatically cycles VBUS when switching between the BC1.2 SDP, BC1.2 DCP, and BC1.2 CDP modes.

### 8.4 Data Pass-through (No Charger Emulation)

When commanded to Data Pass-through mode, UCS1001 will close its USB high-speed data switch to allow USB communications between a portable device and host controller and will operate using trip current limiting. No charger emulation profiles are applied in this mode. Data Pass-through mode will persist until commanded otherwise by the M1, M2, and EM\_EN controls.

**APPLICATION NOTE:** If it is desired that the Data Pass-through mode operates as a traditional / standard port power switch, the S0 control should be set to '0'. When entering this mode, there is no automatic VBUS discharge.

**APPLICATION NOTE:** When the M1, M2, and EM\_EN controls are set to '0', '1', '0' or to '1', '1', '0' respectively, Data Pass-through mode will persist if the PWR\_EN control is disabled; however, the UCS1001 will draw more current. To leave Data Pass-through mode, the PWR\_EN control must be enabled before the M1, M2, and EM\_EN controls are changed to the desired mode.

## 8.5 BC1.2 SDP (No Charger Emulation)

When commanded to BC1.2 SDP mode, UCS1001 will discharge VBUS, close its USB high-speed data switch to allow USB communications between a portable device and host controller, and will operate using trip current limiting. No charger emulation profiles are applied in this mode. BC1.2 SDP mode will persist until commanded otherwise by the M1, M2, EM\_EN, and PWR\_EN controls.

**APPLICATION NOTE:** If it is desired that the BC1.2 SDP mode operates as a traditional / standard port power switch, the S0 control should be set to '0'.

## 8.6 BC1.2 CDP

When BC1.2 CDP is selected as the Active mode, UCS1001 will discharge VBUS, close its USB high-speed data switch, and apply the BC1.2 CDP charger emulation profile which performs handshaking per the specification. The combination of the UCS1001 CDP handshake along with a standard USB host comprises a charging downstream port.

If the handshake is successful, the UCS1001 will operate using constant current limiting (variable slope). If the handshake is not successful, the UCS1001 will leave the applied CDP profile in place, leave the high-speed switch closed, enable constant current limiting, and persist in this condition until commanded otherwise by the M1, M2, EM\_EN, and PWR\_EN controls.

The UCS1001 will respond per the BC1.2 specification to portable device initiated charger renegotiation requests.

**APPLICATION NOTE:** BC1.2 compliance testing may require the S0 control to be set to '0' (Attach and Removal Detection feature disabled) while testing is in progress.

**APPLICATION NOTE:** When the UCS1001 is in BC1.2 CDP mode and the Attach and Removal Detection feature is enabled, if a power thief, such as a USB light or fan, attaches but does not assert DP, a Removal event will not occur when the portable device is removed. However, if a standard USB device is subsequently attached, Removal Detection will again be fully functional. As well, if PWR\_EN is cycled or M1, M2, and / or EM\_EN change state, a Removal event will occur and Attach Detection will be reactivated.

### 8.6.1 BC1.2 CDP Charger Emulation Profile

The BC1.2 CDP charger emulation profile acts as described below.

**APPLICATION NOTE:** All CDP handshaking is performed with the high-speed switch closed.

1. VBUS voltage is applied.
2. Primary Detection - When the portable device drives a voltage between 0.4 V and 0.8 V onto the DPOUT pin, the UCS1001 will drive 0.6 V onto the DMOUT pin within 20 ms.
3. When the portable device drives the DPOUT pin back to '0', the UCS1001 will then drive the DMOUT pin back to '0' within 20 ms.
4. Optional Secondary Detection - If the portable device then drives a voltage of 0.6 V (nominal) onto the DMOUT pin, the UCS1001 will take no other action. This will cause the portable device to observe a '0' on the DPOUT pin and know that it is connected to a CDP.

## 8.7 BC1.2 DCP

When BC1.2 DCP is selected as the Active mode, UCS1001 will discharge VBUS and apply the BC1.2 DCP charger emulation profile per the specification. In BC1.2 DCP mode, the requirement for portable device current draw is automatically disabled. When the BC1.2 DCP charger emulation profile is applied within the Dedicated Charger Emulation Cycle (see [Section 8.10.3, "Legacy 3 Charger Emulation Profile"](#)), the current draw requirement is enabled.

If the portable device is charging after the DCP charger emulation profile is applied, the UCS1001 will leave in place the resistive short, leave the high-speed switch open, and enable constant current limiting (variable slope).

**APPLICATION NOTE:** BC1.2 compliance testing may require the S0 control to be set to '0' (Attach and Removal Detection feature disabled) while testing is in progress.

### 8.7.1 BC1.2 DCP Charger Emulation Profile

The BC1.2 DCP charger emulation profile is described below.

1. VBUS voltage is applied. A resistor ( $R_{DCP\_RES}$ ) is connected between the DPOUT and DMOUT pins.
2. Primary Detection - If the portable device drives 0.6 V (nominal) onto the DPOUT pin, the UCS1001 will take no other action than to leave the resistor connected between DPOUT and DMOUT. This will cause the portable device to see 0.6 V (nominal) on the DMOUT pin and know that it is connected to a DCP.
3. Optional Secondary Detection - If the portable device drives 0.6 V (nominal) onto the DMOUT pin, the UCS1001 will take no other action than to leave the resistor connected between DPOUT and DMOUT. This will cause the portable device to see 0.6 V (nominal) on the DPOUT pin and know that it is connected to a DCP.

## 8.8 Dedicated Charger

When commanded to Dedicated Charger Emulation Cycle mode, the UCS1001 enables an attached portable device to enter its charging mode by applying specific charger emulation profiles in a predefined sequence. Using these profiles, the UCS1001 is capable of generating and recognizing several signal levels on the DPOUT and DMOUT pins. The preloaded charger emulation profiles include ones compatible with YD/T-1591 (2009), Apple, Samsung, and many RIM portable devices.

No active USB data communication is possible when charging in this mode.

### 8.8.1 Emulation Reset

Prior to applying any of the charger emulation profiles, the UCS1001 will perform an emulation reset. This involves the following:

1. The UCS1001 resets the VBUS line by disconnecting the port power switch and connecting VBUS to ground via an internal 100  $\Omega$  resistor. The port power switch will be held open for a time equal to  $t_{EM\_RESET}$  at which point the port power switch will be closed and the VBUS voltage applied.
2. The DPOUT and DMOUT pins will be pulled low using internal 15 k $\Omega$  pull-down resistors.

**APPLICATION NOTE:** To help prevent possible damage to a portable device, the DPOUT and DMOUT pins have current limiting in place when the emulation profiles are applied.

## 8.8.2 Emulation Cycling

In Dedicated Charger Emulation Cycle mode, the charger emulation profiles will be applied in the following order:

1. Legacy 1
2. Legacy 2
3. Legacy 3
4. Legacy 4
5. Legacy 5
6. Legacy 6
7. Legacy 7

**APPLICATION NOTE:** If  $S0=0'$  and a portable device is not attached in DCE Cycle mode, the UCS1001 will be cycling through charger emulation profiles. There is no guarantee which charger emulation profile will be applied first when a portable device attaches.

The UCS1001 will apply a charger emulation profile until one of the following exit conditions occurs:

1. Current greater than  $I_{BUS\_CHG}$  is detected flowing out of VBUS at the respective emulation timeout time. In this case, the profile is assumed to be accepted and no other profiles will be applied.
2. The respective emulation timeout ( $t_{EM\_TIMEOUT}$ ) time is reached without current that exceeds the  $I_{BUS\_CHG}$  limit flowing out of VBUS. The profile is assumed to be rejected, and the UCS1001 will perform emulation reset and apply the next profile, if there is one.

## 8.8.3 DCE Cycle Retry

If none of the charger emulation profiles cause a charge current to be drawn, the UCS1001 will perform emulation reset and cycle through the profiles again. The UCS1001 will continue to cycle through the profiles so as long as charging current is not drawn and the PWR\_EN control is enabled.

## 8.9 Current Limit Mode Associations

The UCS1001 will close the port power switch and use the current limiting mode as shown in [Table 8.2](#).

**Table 8.2 Current Limit Mode Options**

ACTIVE MODE	CURRENT LIMIT MODE
Data Pass-through	Trip mode
BC1.2 SDP	Trip mode
BC1.2 CDP	CC mode if $ILIM \leq 1.5$ A, otherwise, trip mode
BC1.2 DCP	CC mode if $ILIM \leq 1.5$ A, otherwise, trip mode

**Table 8.2 Current Limit Mode Options (continued)**

ACTIVE MODE	CURRENT LIMIT MODE
<b>DCE CYCLE</b>	
During DCE Cycle when a charger emulation profile is being applied	CC mode if $ILIM \leq 1.5$ A, otherwise, trip mode
Legacy 2 charger emulation profile accepted	CC mode if $ILIM \leq 1.5$ A, otherwise, trip mode
Legacy 1 or Legacy 3 - Legacy 7 charger emulation profile accepted	Trip mode

## 8.10 Preloaded Charger Emulation Profiles

The following charger emulation profiles are resident to the UCS1001:

1. Legacy 1 - See [Section 8.10.1](#)
2. Legacy 2, 4, 5, and 7 - See [Section 8.10.2](#)
3. Legacy 3 - See [Section 8.10.3](#)
4. Legacy 6 - See [Section 8.10.4](#)
5. BC1.2 CDP - See [Section 8.6.1](#)
6. BC1.2 DCP - See [Section 8.7.1](#)

### 8.10.1 Legacy 1 Charger Emulation Profile

Legacy 1 charger emulation profile does the following:

1. The UCS1001 will apply 900 mV to both the DPOUT and the DMOUT pins.
2. VBUS voltage is applied.
3. If the portable device is charging, the UCS1001 will accept that the currently applied profile is the correct charger emulation profile for the attached portable device. The voltages applied to the DPOUT and DMOUT pins will remain in place. The UCS1001 will begin operating in trip mode
4. If the portable device is not charging, the UCS1001 will stop the currently applied charger emulation profile. This will cause all voltages put onto the DPOUT and DMOUT pins to be removed. Emulation reset occurs, and the UCS1001 will initiate the next charger emulation profile.

### 8.10.2 Legacy 2, 4, 5, and 7 Charger Emulation Profiles

Legacy 2, 4, 5, and 7 charger emulation profiles follow the same pattern of operation although the voltage that is applied on the DPOUT and DMOUT pins will vary. They do the following:

1. The UCS1001 will apply a voltage on the DPOUT pin using either a current-limited voltage source or a voltage divider between VBUS and ground with the center tap on the DPOUT pin.
2. The UCS1001 will apply a possibly different voltage on the DMOUT pin using either a current-limited voltage source or a voltage divider between VBUS and ground with the center tap on the DMOUT pin.
3. VBUS voltage is applied.

4. If the portable device is charging, the UCS1001 will accept that the currently applied profile is the correct charger emulation profile for the attached portable device. The voltages applied to the DPOUT and DMOUT pins will remain in place. The UCS1001 will begin operating in trip mode
5. If the portable device is not charging, the UCS1001 will stop the currently applied charger emulation profile. This will cause all voltages put onto the DPOUT and DMOUT pins to be removed. Emulation reset occurs, and the UCS1001 will initiate the next charger emulation profile.

### 8.10.3 Legacy 3 Charger Emulation Profile

The Legacy 3 charger emulation profile does the following:

1. The UCS1001 will connect a resistor ( $R_{DCP\_RES}$ ) between DPOUT and DMOUT.
2. VBUS is applied.
3. If the portable device is charging, the UCS1001 will accept that this is the correct charger emulation profile for the attached portable device. The resistive short between the DPOUT and DMOUT pins will be left in place.
4. If the portable device is not charging, the UCS1001 will stop the Legacy 3 charger emulation. This will cause resistive short between the DPOUT and DMOUT pins to be removed. Emulation reset occurs, and the UCS1001 will initiate the next charger emulation profile.

### 8.10.4 Legacy 6 Charger Emulation Profile

The Legacy 6 charger emulation profile does the following:

1. The UCS1001 will apply a voltage on the DPOUT pin using a voltage divider between VBUS and ground with the center tap on the DPOUT pin.
2. VBUS voltage is applied.
3. If the portable device is charging, the UCS1001 will accept that Legacy 6 is the correct charger emulation profile for the attached portable device. The voltage applied to the DPOUT pin will remain in place. The UCS1001 will begin operating in trip mode
4. If the portable device is not charging, the UCS1001 will stop the Legacy 6 charger emulation profile. This will cause the voltage put onto the DPOUT pin to be removed. Emulation reset occurs, and the UCS1001 will initiate the next charger emulation profile.



## Chapter 9 Package Information

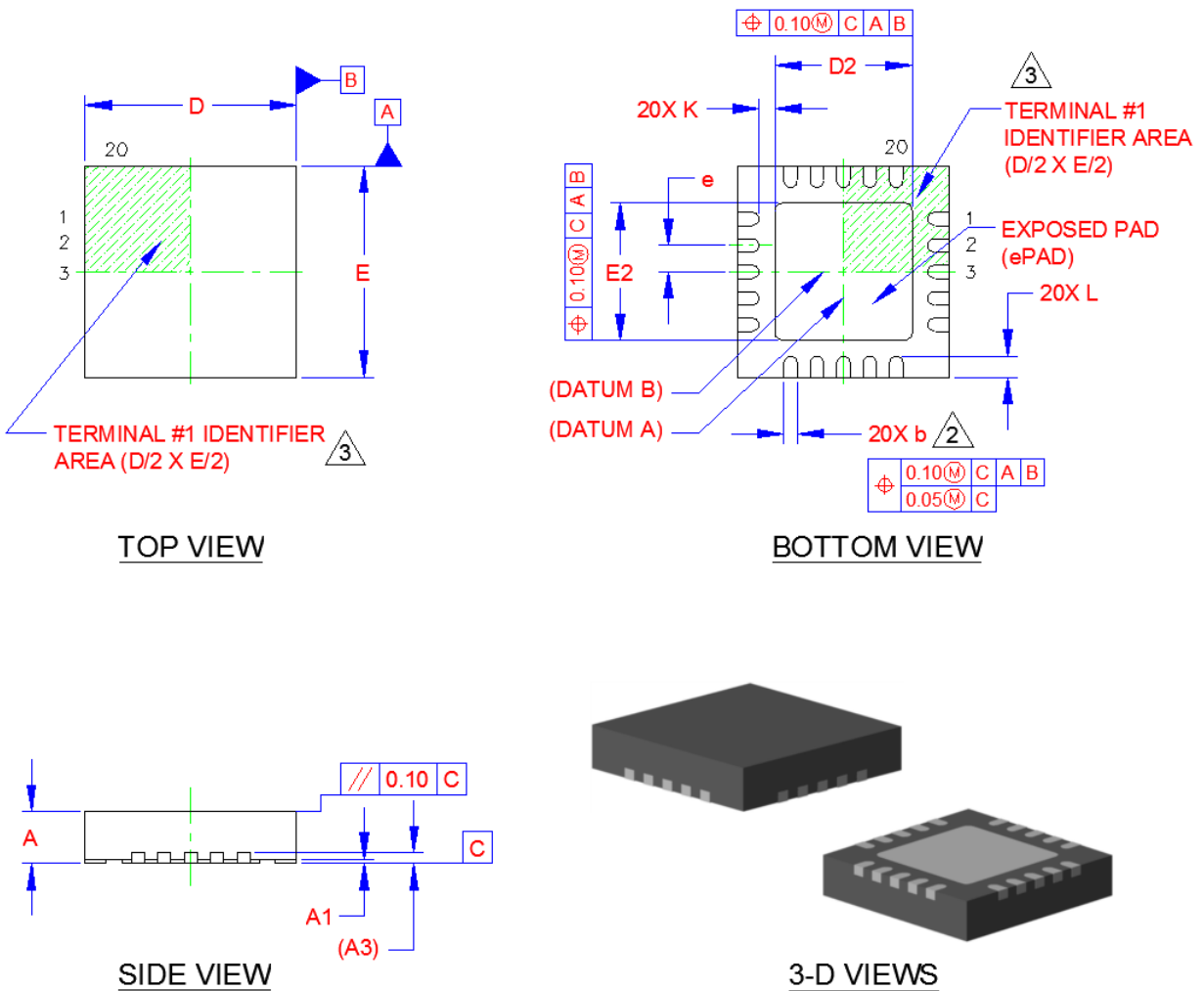

Figure 9.1 UCS1001 Package View

COMMON DIMENSIONS					
SYMBOL	MIN	NOM	MAX	NOTE	REMARK
A	0.80	0.85	0.90	-	OVERALL PACKAGE HEIGHT
A1	0	0.02	0.05	-	STANDOFF
A3	0.20 REF			-	LEAD-FRAME THICKNESS
D/E	3.90	4.00	4.10	-	X/Y BODY SIZE
D2/E2	2.50	2.60	2.70	-	X/Y EXPOSED PAD SIZE
L	0.30	0.40	0.50	-	TERMINAL LENGTH
b	0.18	0.25	0.30	2	TERMINAL WIDTH
K	0.25	0.30	-	-	TERMINAL TO PAD DISTANCE
e	0.50 BSC			-	TERMINAL PITCH

**NOTES:**

1. ALL DIMENSIONS ARE IN MILLIMETERS.
2. DIMENSIONS "b" APPLIES TO PLATED TERMINALS AND IT IS MEASURED BETWEEN 0.15 AND 0.30 mm FROM THE TERMINAL TIP.
3. DETAILS OF TERMINAL #1 IDENTIFIER ARE OPTIONAL BUT MUST BE LOCATED WITHIN THE AREA INDICATED.

**Figure 9.2 UCS1001 Package Dimensions and Notes**

# Chapter 10 Typical Operating Curves

Figure 10.1 USB-IF High-speed Eye Diagram (without data switch)

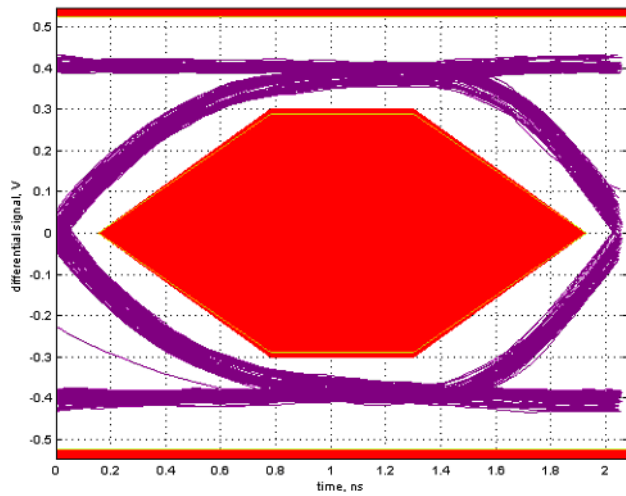

Figure 10.2 USB-IF High-speed Eye Diagram (with data switch)

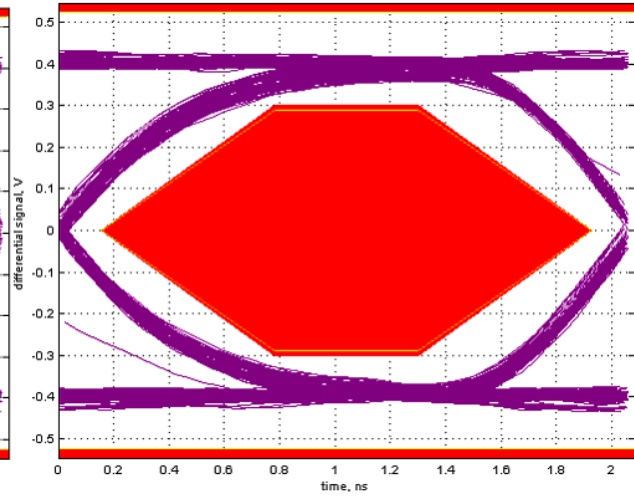

Figure 10.3 Short Applied After Power Up

VS = VDD = 5 V, ILIM = 2.5 A, short applied at 3 ms

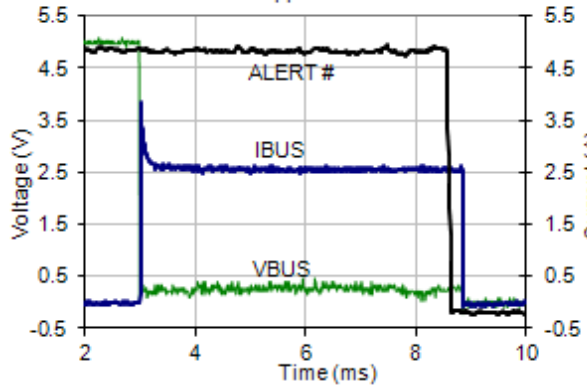

Figure 10.4 Power Up Into A Short

VS = VDD = 5 V, short applied at 16 ms

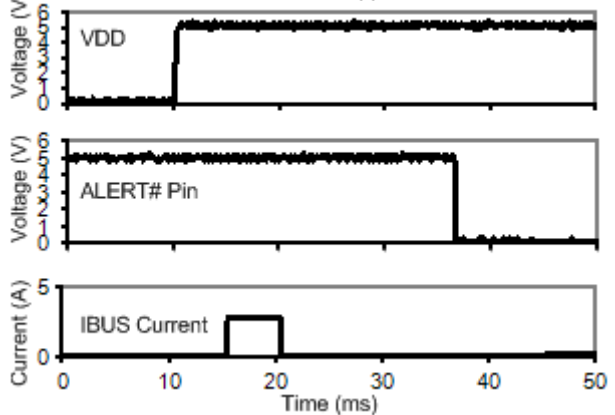

Figure 10.5 Internal Power Switch Short Response

VS = VDD = 5 V, ILIM = 1.8 A, short applied at 8.8 us

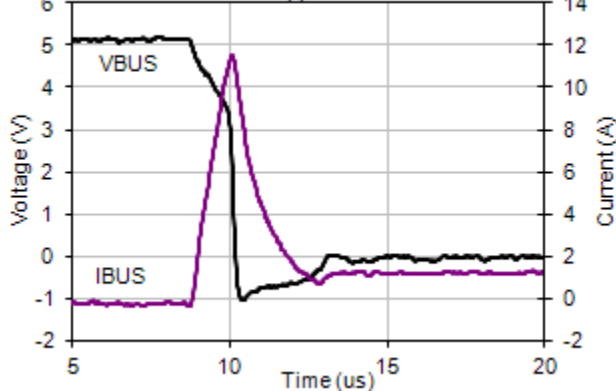

Figure 10.6 VBUS Discharge Behavior

VS = VDD = 5 V, M2 = 0, M1 = PWR\_EN = 1

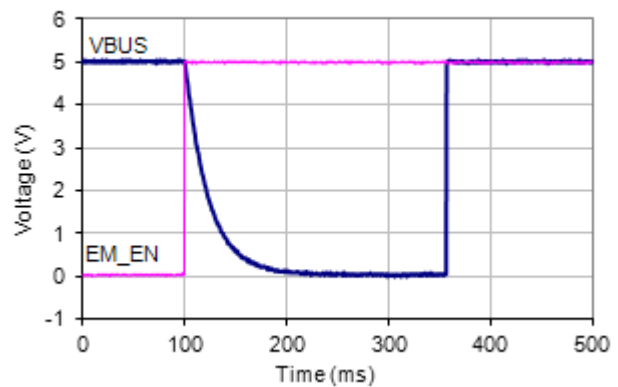

Figure 10.7 Data Switch Off Isolation vs. Frequency



Figure 10.8 Data Switch Bandwidth vs. Frequency

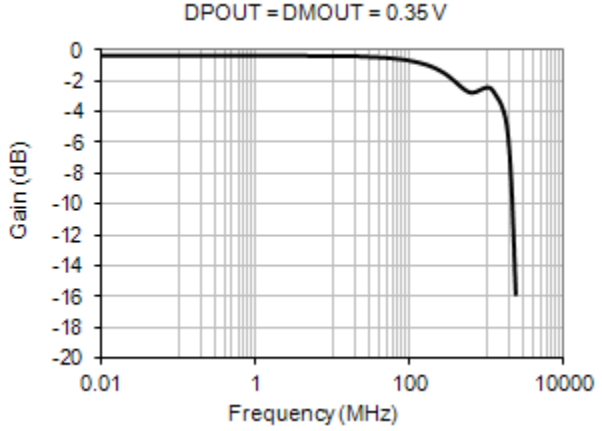

Figure 10.9 Data Switch On Resistance vs. Temp

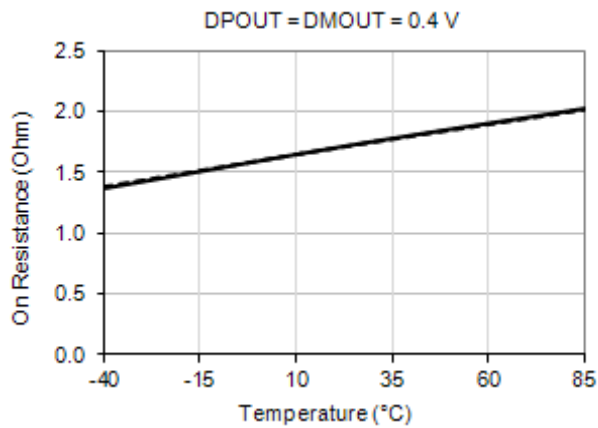

Figure 10.10 Power Switch On Resistance vs. Temp

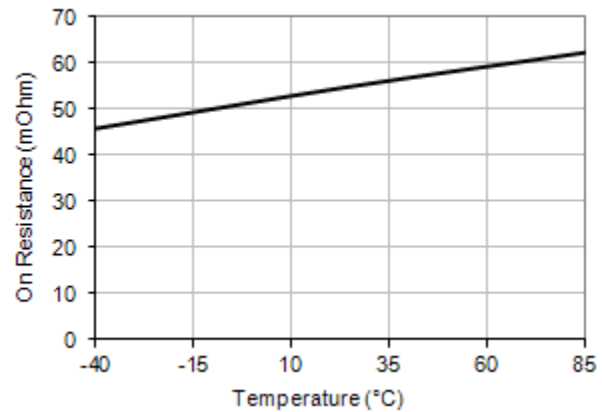

Figure 10.11 R<sub>DCP\_RES</sub> Resistance vs. Temp

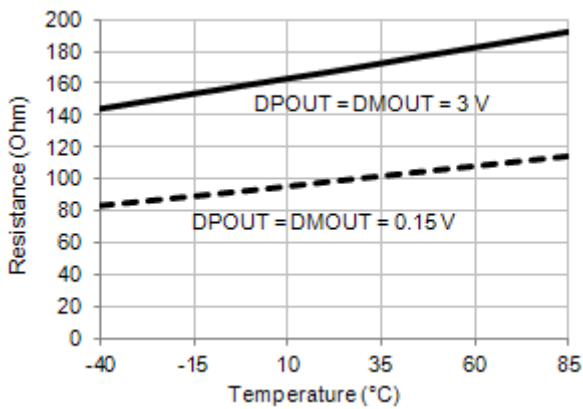

Figure 10.12 Power Switch On / Off Time vs. Temp

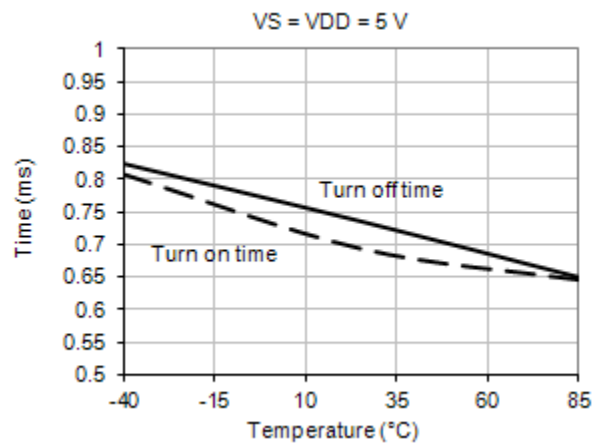

Figure 10.13 VS Over-Voltage Threshold vs. Temp

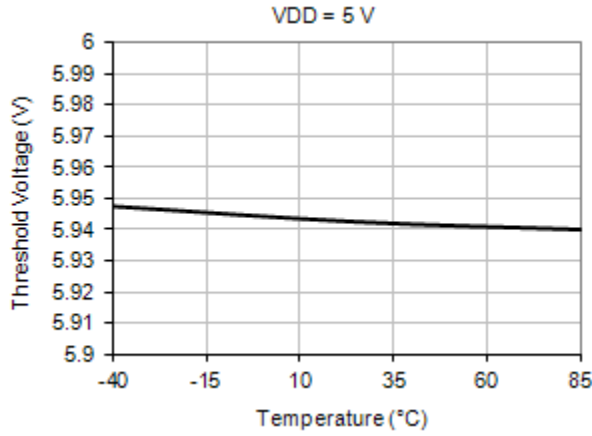

Figure 10.14 VS Under Voltage Threshold vs. Temp

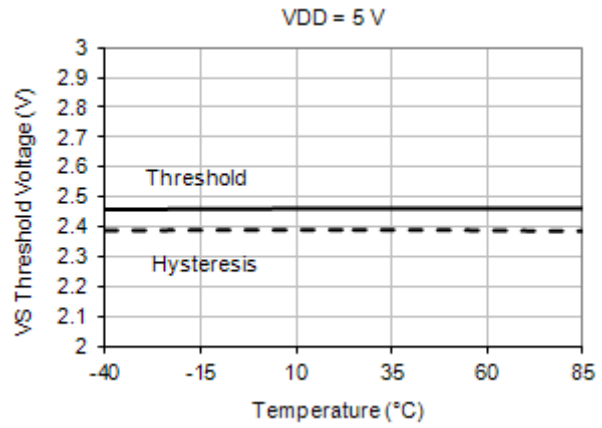

Figure 10.15 Detect State VBUS vs. IBUS

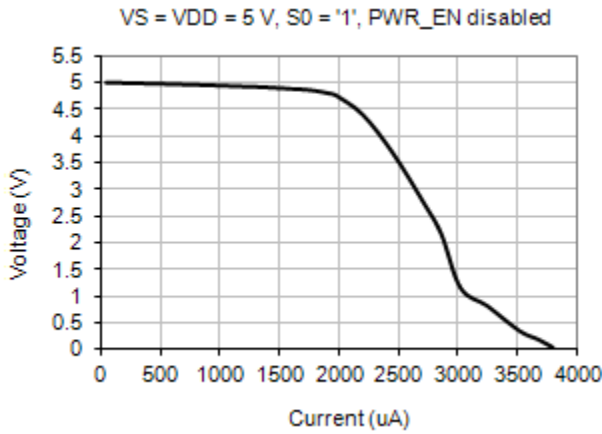

Figure 10.16 Trip Current Limit Operation vs. Temp.

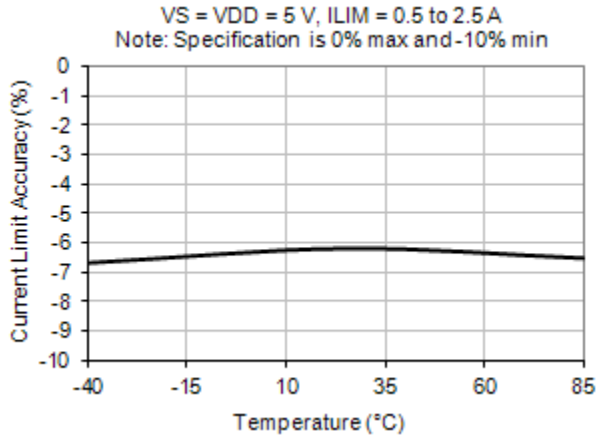
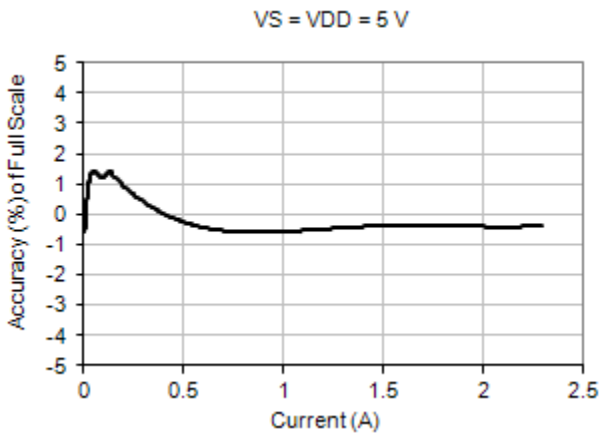

Figure 10.17 IBUS Measurement Accuracy



**Figure 10.18 Active State Current vs. Temp**



**Figure 10.19 Detect State Current vs. Temp**

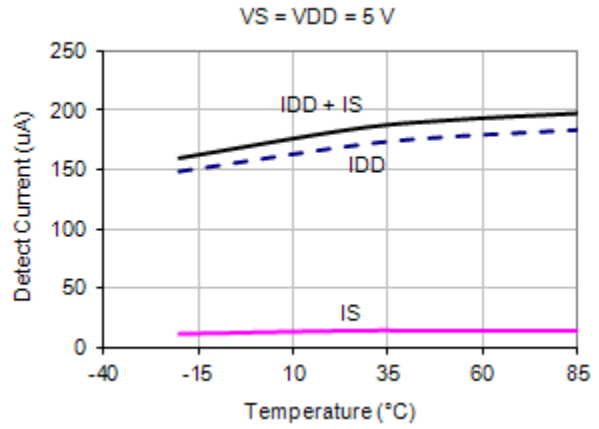

**Figure 10.20 Sleep State Current vs. Temp**

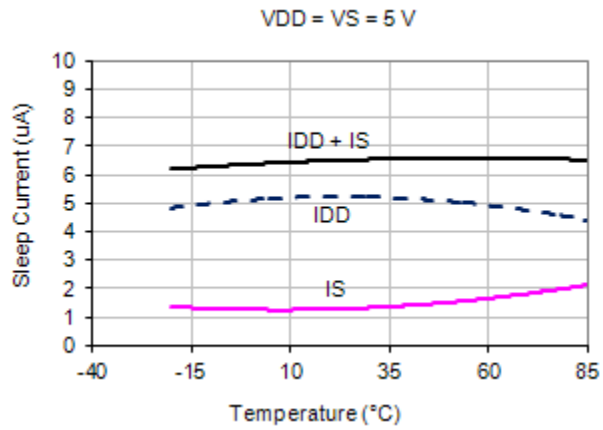

## Chapter 11 Document Revision History

Table 11.1 Customer Revision History

REVISION LEVEL & DATE	SECTION/FIGURE/ENTRY	CORRECTION
Revision 1.4 (07-16-13)	Cover	<ul style="list-style-type: none"> <li>Added patent information to cover</li> </ul>
	Table 3.3, "Electrical Specifications"	<ul style="list-style-type: none"> <li>Added specifications for <math>I_{DET\_QUAL}</math> / <math>I_{REM\_QUAL}</math> and <math>I_{BUS\_CHG}</math></li> </ul>
	Section 9.8.2, "Emulation Cycling"	<ul style="list-style-type: none"> <li>Updated text for DCE cycle behavior. Changed cycle order for 1001-3 and 1001-4.</li> </ul>
Revision 1.3 (02-14-13)	Table 3.3, "Electrical Specifications"	<ul style="list-style-type: none"> <li>Added Pin Wake Time (<math>t_{PIN\_WAKE}</math>).</li> <li>Changed <math>I_{SLEEP}</math> from 8 <math>\mu A</math> (MAX) to 15 <math>\mu A</math> (MAX) per characterization data.</li> <li>Added 12W Current Limit changes.</li> </ul>
	Figure 4.5, "Wake Timing"	<ul style="list-style-type: none"> <li>Changed ~3ms to <math>t_{PIN\_WAKE}</math>. Removed third example: "Wake with S0 &amp; PWR_EN to Auto-transition Detect State (<math>V_S &gt; V_S\_UVLO</math>, M1 &amp; M2 &amp; EM_EN not all '0' and not set to Data Pass-through)".</li> </ul>
	Chapter 4, General Description	<ul style="list-style-type: none"> <li>After system diagrams, noted that is available.</li> </ul>
	Chapter 11, Document Revision History	<ul style="list-style-type: none"> <li>Added.</li> </ul>
Revision 1.2 (05-21-12)	Cover	<ul style="list-style-type: none"> <li>Certification added: "UL recognized and EN/IEC 60950-1 (CB) certified"</li> </ul>
Revision 1.2 (05-16-12)	Cover	<ul style="list-style-type: none"> <li>Source voltage: <math>V_S</math> MIN moved from 2.7 to 2.9 V to accommodate UL</li> </ul>
	Table 3.3, "Electrical Specifications"	<ul style="list-style-type: none"> <li>Source voltage: <math>V_S</math> MIN moved from 2.7 to 2.9 V to accommodate UL</li> </ul>
	Cover	<ul style="list-style-type: none"> <li>There are nine preloaded charger emulation profiles.</li> </ul>
	Chapter 2, Pin Description	<ul style="list-style-type: none"> <li>Changed "unused connection" to n/a for ILIM, SEL, LATCH, and S0 pins as they must be used.</li> <li>Added Note 2.1: Total leakage current from pins 3 and 4 (VBUS) to ground must be less than 100 <math>\mu A</math> for proper attach / removal detection operation.</li> </ul>
	Table 3.3, "Electrical Specifications"	<ul style="list-style-type: none"> <li>Updated selectable current limits (ILIMx) min and max values. Typical values did not change.</li> <li>Changed <math>I_{ACTIVE}</math> from 500 <math>\mu A</math> (TYP) to 650 <math>\mu A</math> (TYP).</li> <li>Changed <math>I_{ACTIVE}</math> from TBD <math>\mu A</math> (MAX) to 750 <math>\mu A</math> (MAX).</li> <li>Changed <math>I_{SLEEP}</math> from TBD <math>\mu A</math> (MAX) to 8 <math>\mu A</math> (MAX).</li> <li></li> <li></li> </ul>
	Table 4.1, "Power States Control Settings"	<ul style="list-style-type: none"> <li>"Behavior" cell in the "Sleep" row: Clarified behavior by adding "VBUS will be near ground potential".</li> </ul>
	Section 4.1.2, "Sleep State Operation"	<ul style="list-style-type: none"> <li>Clarified behavior by adding "VBUS will be near ground potential".</li> </ul>

Table 11.1 Customer Revision History (continued)

REVISION LEVEL & DATE	SECTION/FIGURE/ENTRY	CORRECTION
	Section 4.2.3, "Back-voltage Detection" and Section 4.2.4, "Back-drive Current Protection"	<ul style="list-style-type: none"> <li>■ Section "Back-voltage / Back-drive Detection" split into two.</li> <li>■ In Section 4.2.4, "Back-drive Current Protection", corrected reference <math>I_{BD\_LK}</math> to match elec spec symbol <math>I_{BD\_1}</math> and rewrote back-drive description.</li> </ul>
	Section 6.2.4, "Current Limiting Modes"	<ul style="list-style-type: none"> <li>■ Added: The current limiting mode used depends on the Active state mode (see Section 9.9, "Current Limit Mode Associations").</li> </ul>
	Section 6.2.4.1, "Trip Mode"	<ul style="list-style-type: none"> <li>■ Added application note: To avoid cycling in trip mode, set ILIM higher than the highest expected portable device current draw.</li> </ul>
	Table 9.2, "Current Limit Mode Options"	<ul style="list-style-type: none"> <li>■ Rearranged rows so DCE Cycle is grouped together.</li> <li>■ Added row for DCE Cycle when a charger emulation profile is being applied.</li> </ul>
	Section 9.8.2, "Emulation Cycling" and Section 9.11.5, "Legacy 7 Charger Emulation Profile"	<ul style="list-style-type: none"> <li>■ Legacy 7 charger emulation profile .</li> </ul>
	Chapter 10, Typical Operating Curves	<ul style="list-style-type: none"> <li>■ Rearranged order of TOCs.</li> <li>■ Added new TOCs: <ul style="list-style-type: none"> <li>— Figure 10.3, "Short Applied After Power Up"</li> <li>— Figure 10.5, "Internal Power Switch Short Response"</li> <li>— Figure 10.16, "Trip Current Limit Operation vs. Temp."</li> <li>— Figure 10.17, "IBUS Measurement Accuracy"</li> <li>— Figure 10.18, "Active State Current vs. Temp"</li> <li>— Figure 10.19, "Detect State Current vs. Temp"</li> <li>— Figure 10.20, "Sleep State Current vs. Temp"</li> </ul> </li> <li>■ Updated the following: <ul style="list-style-type: none"> <li>— Figure 10.6, "VBUS Discharge Behavior"</li> <li>— Figure 10.11, "RDCP_RES Resistance vs.Temp"</li> <li>— Figure 10.13, "VS Over-Voltage Threshold vs. Temp"</li> <li>— Figure 10.14, "VS Under Voltage Threshold vs. Temp"</li> <li>— Figure 10.15, "Detect State VBUS vs. IBUS"</li> </ul> </li> </ul>
Revision 1.1 (11-21-11)	Table 3.2, "Power Dissipation Summary"	<ul style="list-style-type: none"> <li>■ Missing units added.</li> </ul>
	Table 3.3, "Electrical Specifications"	<ul style="list-style-type: none"> <li>■ Changed <math>t_{DET\_CHARGE}</math> from 400 ms to 800 ms typ and changed condition from <math>C_{BUS} = 220 \mu F</math> to <math>C_{BUS} = 500 \mu F</math> max.</li> <li>■ VS Leakage Current changed from 0.8 <math>\mu A</math> typical to 2.2 <math>\mu A</math>.</li> <li>■ Changed <math>I_{BD\_1}</math> and <math>I_{BD\_2}</math> from TBD typ to 0 <math>\mu A</math> typ and from 1.5 <math>\mu A</math> max to 2 <math>\mu A</math> max</li> <li>■ Changed <math>I_{TST}</math> to <math>I_{TEST}</math> and changed typ from 165 to 190 mA.</li> <li>■ Changed <math>t_{ON\_PSW}</math> from 3 ms to 0.75 ms typical and <math>t_{OFF\_PSW\_INA}</math> from 1 ms to 0.75 ms typical.</li> </ul>
	Table 3.4, "ESD Ratings"Section 3.1	<ul style="list-style-type: none"> <li>■ Charged Device Model: changed from 200 V to 500 V</li> </ul>
	Note 4.1	<ul style="list-style-type: none"> <li>■ Added note: In order to transition from Active state Data Pass-through mode into Sleep with these settings, change the M1, M2, and EM_EN pins before changing the PWR_EN pin.</li> </ul>



Table 11.1 Customer Revision History (continued)

REVISION LEVEL & DATE	SECTION/FIGURE/ENTRY	CORRECTION
	Table 4.1, "Power States Control Settings", Section 4.1.2, "Sleep State Operation", Section 5.1, "USB High-speed Data Switch"	<ul style="list-style-type: none"> <li>The high-speed switch is open in Sleep.</li> </ul>
	Section 4.2.2, "VS Source Voltage"	<ul style="list-style-type: none"> <li>Added.</li> </ul>
	Cover, Section 9.11.3, "Legacy 1, 3, 4, and 6 Charger Emulation Profiles"	<ul style="list-style-type: none"> <li>Legacy 6 profile has been defined.</li> </ul>
Revision 1.1 (11-21-11) cont.	Section 9.4, "Data Pass-through (No Charger Emulation)"	<ul style="list-style-type: none"> <li>Data Pass-through persists until M1, M2, or EM_EN controls are changed. It is no longer affected by PWR_EN. Added application note: When the M1, M2, and EM_EN controls are set to '0', '1', '0' or to '1', '1', '0' respectively, Data Pass-through mode will persist if the PWR_EN control is disabled; however, the UCS1001 will draw more current. To leave Data Pass-through mode, the PWR_EN control must be enabled before the M1, M2, and EM_EN controls are changed to the desired mode.</li> </ul>
	Section 9.6, "BC1.2 CDP"	<ul style="list-style-type: none"> <li>BC1.2 CDP mode uses constant current limiting. Added application note: BC1.2 compliance testing may require the S0 control to be set to '0' (Attach and Removal Detection feature disabled) while testing is in progress.</li> <li>Added application note: When the UCSX100X is in BC1.2 CDP mode and the Attach and Removal Detection feature is enabled, if a power thief, such as a USB light or fan, attaches but does not assert DP, a Removal event will not occur when the portable device is removed. However, if a standard USB device is subsequently attached, Removal Detection will again be fully functional. As well, if PWR_EN is cycled or M1, M2, and / or EM_EN change state, a Removal event will occur and Attach Detection will be reactivated.</li> </ul>
	Section 9.7, "BC1.2 DCP"	<ul style="list-style-type: none"> <li>Added application note: BC1.2 compliance testing may require the S0 control to be set to '0' (Attach and Removal Detection feature disabled) while testing is in progress.</li> </ul>
	Table 9.2, "Current Limit Mode Options"	<ul style="list-style-type: none"> <li>BC1.2 CDP charger emulation changed from using "trip" to "CC mode if ILIM &lt; 1.5 A, otherwise, trip mode".</li> </ul>
	Section 9.11.4, "Legacy 5 Charger Emulation Profile"	<ul style="list-style-type: none"> <li>Added. The Legacy 5 charger emulation profile no longer applies a voltage divider. It applies 900 mV to DPOUT and DMOUT.</li> </ul>
Revision 1.0 (08-18-11)	Initial Release	

# Mouser Electronics

Authorized Distributor

Click to View Pricing, Inventory, Delivery & Lifecycle Information:

[Microchip:](#)

[UCS1001-4-BP-TR](#) [UCS1001-4-BP](#) [UCS1001-3-BP-TR](#) [UCS1001-3-BP](#)