

**General Description**

The MAX11905 differential evaluation kit (EV kit) demonstrates the MAX11905, 20-bit, 1.6Msps, single-channel, fully differential SAR ADC with internal reference buffers. The EV kit uses the MAX44205, a low-noise fully differential operational amplifier. The EV kit includes a graphical user interface (GUI) that provides communication from Avnet’s ZedBoard™ development board for the Xilinx Zynq®-7000 SoC. The ZedBoard, not included with the EV kit, must be purchased through Avnet, Inc.

The ZedBoard communicates with the PC through an Ethernet cable using Windows XP®, Windows Vista®, Windows® 7-, or Windows 8/8.1-compatible software.

The EV kit comes with the MAX11905ETP+ installed.

**Features**

- Peripheral Module and FMC Connector for Interface
- 75MHz SPI Clock Capability through FMC Connector
- 37.5MHz SPI Clock Capability through Peripheral Module Connector
- Sync In and Sync Out for Coherent Sampling
- On-Board Input Buffer (MAX44205)
- On-Board +3.0V Reference Voltage (MAX6126)
- Windows XP-, Windows Vista-, Windows 7-, and Windows 8/8.1-Compatible Software

*Ordering Information appears at end of data sheet.*

**System Block Diagram**

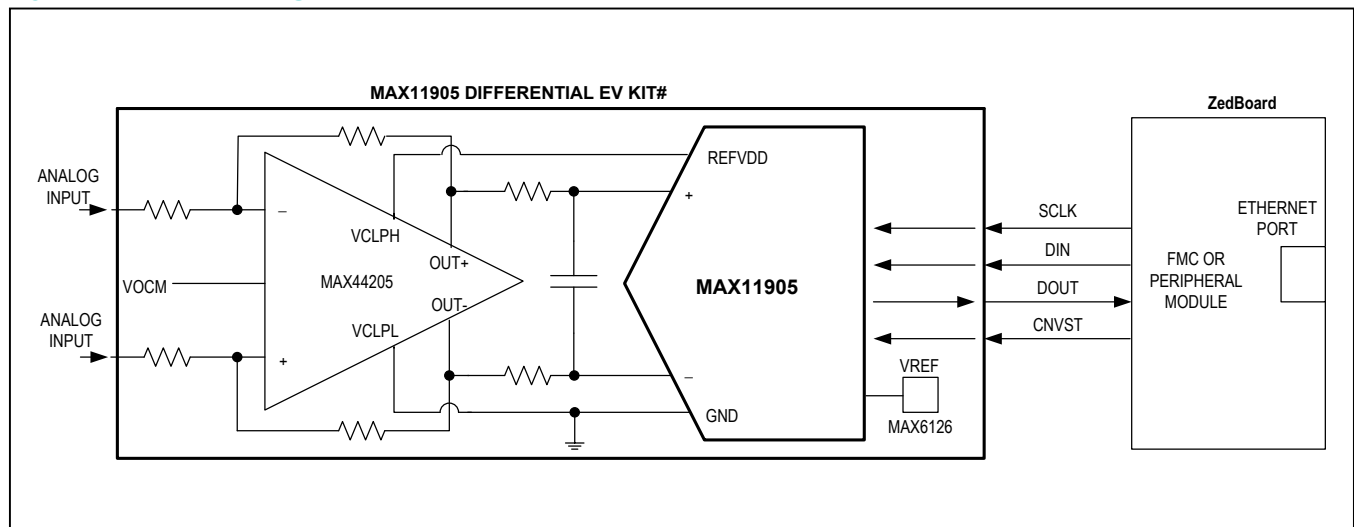

*ZedBoard is a trademark of Avnet, Inc.*

*Zynq is a registered trademark of Xilinx, Inc.*

*Windows, Windows XP, and Windows Vista are registered trademarks and registered service marks of Microsoft Corporation.*

## Quick Start

### Required Equipment

- MAX11905 differential EV kit with SD card
- ZedBoard development board (includes Micro-USB A-to-B cables)
- Windows PC
- Ethernet cable
- +5V DC power supply
- ±5V dual DC power supply
- Signal generator with differential outputs (e.g., Audio Precision 2700 series)
- Soldering iron and 2-pin, 2.54 header

**Note:** In the following sections, software-related items are identified by bolding. Text in **bold** refers to items directly from the EV kit software. Text in **bold and underlined** refers to items from the Windows operating system.

### Procedure

The EV kit is fully assembled and tested. Follow the steps below to verify board operation:

- 1) Download the LabVIEW® Run-Time Engine 2013 from [www.ni.com/download/labview-run-time-engine-2013/4059/en/](http://www.ni.com/download/labview-run-time-engine-2013/4059/en/).
- 2) Visit [www.maximintegrated.com/evkitsoftware](http://www.maximintegrated.com/evkitsoftware) to download the latest version of the EV kit software, 11905EVKit.ZIP. Save the EV kit software to a temporary folder and uncompress the ZIP file.
- 3) Solder the 2-pin header on J18-3V3 of the ZedBoard.
- 4) Connect the Ethernet cable from the PC to the ZedBoard and configure the **Internet Protocol Version 4 (TCP/IPv4)** properties in the local area connection to IP address **192.168.1.2** and the subnet mask to **255.255.255.0**.
- 5) Connect the USB cable from the PC to the ZedBoard's USB programming connector (J17).
- 6) Verify that the ZedBoard's jumpers JP7, JP8, and JP11 have shunts installed at the GND position, and JP9 and JP10 at the 3V3 position.
- 7) Move the shunt of J18 of the ZedBoard from 1V8 to the 3V3 position.
- 8) Insert the SD card with the boot image (BOOT.bin).
- 9) Verify that all jumpers on the EV kit are in their default positions, as shown in [Table 1](#).
- 10) Connect the ZedBoard to J2 on the EV kit for FMC connection. If the peripheral module is used, the ZedBoard's JA1 connector must be connected to J1 on the EV kit.
- 11) Connect the positive terminal of the +5V supply to the +5V test point and the negative terminal to the GND test point.
- 12) Connect the +5V of the dual supply to the VS+ test point, the -5V supply to the VS- test point, and the ground to the GND test point.
- 13) The configuration of the op amp is gain of 0.5. Set the signal generator to 11.95V<sub>P-P</sub> and 10kHz to the INP and INM SMA connectors or test points on the EV kit.
- 14) Turn on the power to the ZedBoard.
- 15) Turn on all power supplies.
- 16) Enable the function generator.
- 17) Open the EV kit GUI, MAX11905EVKit.exe.
- 18) Verify that the IP Address is **192.168.1.10**, the port is **6001**, and that the status bar displays **TCP/IP Connection to Zedboard is successful and Connected to ZedBoard (MISO = 1)**.
- 19) Click on the **Set** button within the **Configuration** tab.
- 20) Click on the **FFT** tab ([Figure 6](#)) and start capturing data.

**Table 1. Jumper Descriptions (JU1–JU14)**

JUMPER	SHUNT POSITION	DESCRIPTION
JU1	Installed	Connects to 49.9Ω termination.
	Not installed*	Apply negative end of the differential signal at the INM test point or SMA connector.
JU2	Installed	Connects to 49.9Ω termination.
	Not installed*	Apply positive end of the differential signal at the INP test point or SMA connector.
JU3	1-2*	Connects to VOCM to REF/2.
	2-3	Connects to VOCM to GND.
JU4	Installed*	DVDD supply connects to the on-board +1.8V LDO
	Not installed	User-supplied DVDD. Apply +1.8V at the DVDD test point.
JU5	1-2*	REFIN connects to the on-board +3.0V reference.
	2-3	User-supplied REFIN. Apply reference voltage at the EXT_REFIN test point.
JU6	1-2	Do not use
	2-3*	OVDD supply connects to the on-board +3.3V LDO
	Not installed	User-supplied OVDD. Apply +3.3V at the OVDD test point.
JU7	Installed*	AVDD supply connects to the on-board +1.8V LDO
	Not installed	User-supplied AVDD. Apply +1.8V at the jumper JU7-2 pin.
JU8	Installed*	REFVDD supply connects to the on-board +3.3V LDO.
	Not installed	User-supplied REFVDD. Apply +3.3V at the JU9-2 pin.
JU9	2-3, 5-6, 8-9, 11-12*	Connects the SPI signals coming from the peripheral module or FMC connectors to the MAX11905.
	Not installed	User-supplied SPI. Connect the SPI signals at the SCLK, CNVST, DIN, and DOUT test points.
JU10	Installed	Disables the line driver.
	Not installed*	Enables the line driver.
JU11	Installed*	Input common mode voltage set to REF/2.
	Not installed	Input common mode voltage set GND.
JU12	1-2*	VCLPH set to MAX11905's REFVDD supply.
	2-3	VCLPH set to MAX44205's VS+ supply.
JU13	1-2*	VCLPL set to GND.
	2-3	VCLPL set to MAX44205's VS- supply.
JU14	1-2*	$\overline{\text{SHDN}}$ pulled to VS+ and set to normal operation.
	2-3	$\overline{\text{SHDN}}$ pulled to GND and set to shutdown mode.

\*Default position.

### General Description of Software

The main window of the MAX11905 EV kit software contains five tabs: **Configuration**, **Scope**, **DMM**, **Histogram**, and **FFT**. The **Configuration** tab sheet provides control to communicate with the ZedBoard, SPI, and the IC registers. The other four tabs are used for evaluating the IC's high-speed ADC.

### Configuration Tab

When all connections are made on the system and are fully powered, the **Configuration** tab sheet displays the correct IP address, port, and the lower status bar displays as shown [Figure 1](#). These are all indicators that the system and GUI are ready for communication.

Before proceeding, connect the connector used on the ZedBoard to either the FMC or PMOD connector on the EV kit. If the FMC connector is used, all SCLK frequencies are applicable. If the PMOD connector is used, the maximum allowed frequency is 37.5MHz. For the **Clock Source** selection, the ZedBoard internal clock is always a valid option. If the external clock is selected, an external

clock must be applied at the DCLK\_IN SMA on the EV kit. The **Sync-Out CLK (10MHz)** checkbox is used to synchronize the signal generator with a 10MHz input. See the *Sync Input and Sync Output* section for more information. Once the above configurations are completed, adjust to the desired sampling rate, reference voltage, and number of samples, and then click on the **Set** button.

Also in this tab sheet are the IC register controls. The Mode register is accessible using the controls on the **MAX11905 Mode Register Configuration** group box in the center, or the **Mode** control on the right. All other registers are read-only and are updated by clicking on the appropriate **Read** button. The first and second REF must be shorted on the board to use the REF controls. The GUI forces these two controls to the same value. The GUI forces these two controls to the same value, regardless of the user's choice.

The **Reset** button resets the firmware, as well as the device. It sends 0x8000 to the Mode register and causes the device to do a power-on reset. The **Set** button needs to be clicked to save the current screen settings.

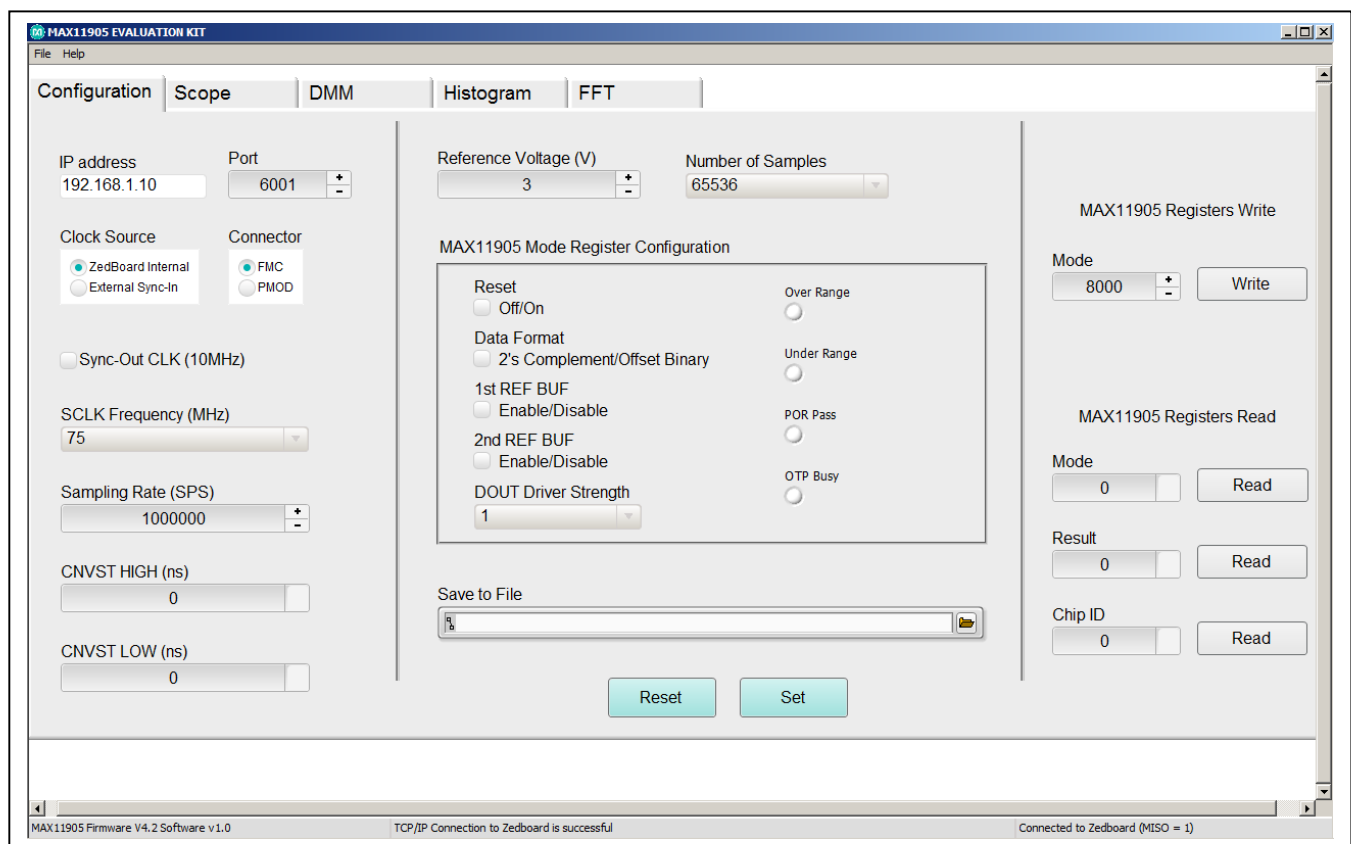

Figure 1. MAX11905 EV Kit Main Window (Configuration Tab)

### Scope Tab

The **Scope** tab sheet is used to capture data and display it in the time domain. Sampling rate and number of samples can also be set in this tab if they were not adjusted appropriately in other tabs. The **Display Unit** drop-down list allows counts and voltages. Once the desired configuration is set, click on the **Capture** button. The right side of the tab sheet displays details of the waveform, such as

average, standard deviation, maximum, minimum, and fundamental frequency.

[Figure 2](#) displays the ADC data when differential sinusoidal are applied at the inputs on the EV kit.

### DMM Tab

The DMM tab sheet provides the typical information as a digital multimeter. Once the desired configuration is set, click on the **Capture** button.

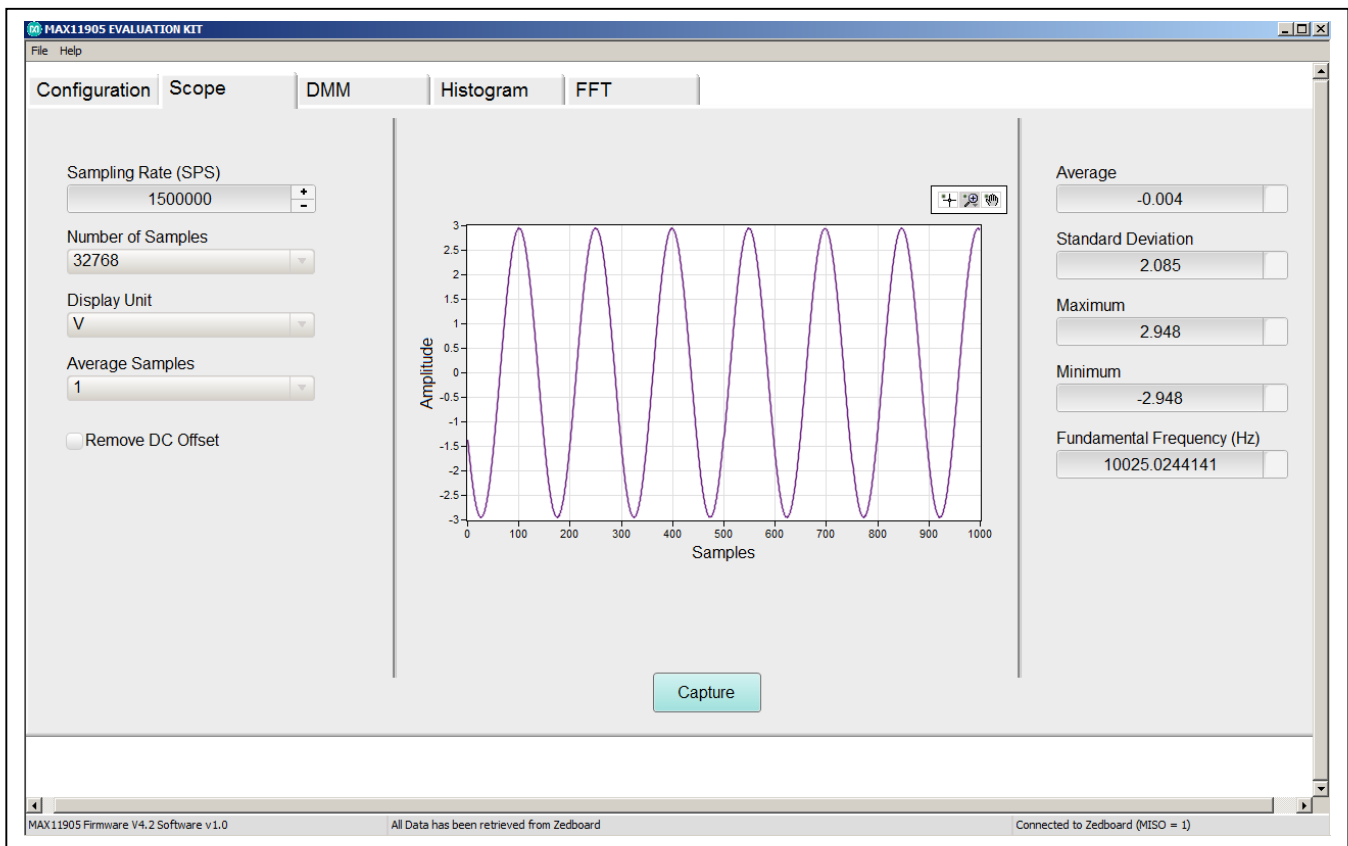

Figure 2. MAX11905 EV Kit Main Window (Scope Tab)

Figure 3 displays the numerical value when the inputs on the EV kit are shorted to ground using the jumpers (JU1 and JU2). See Table 1 for shunt settings.

### Histogram Tab

The Histogram tab sheet is used to capture the histogram of the data. Sampling rate and number of samples can also be set in this tab if they were not adjusted appropriately in other tabs. Make sure that the number of samples do not exceed 524,288; otherwise, data capturing is

longer than expected. Once the desired configuration is set, click on the **Capture** button. The right side of the tab sheet displays details of the histogram such as average, standard deviation, maximum, minimum, peak-to-peak noise, effective resolution, and noise-free resolution.

To use this histogram feature, apply a DC voltage at the input. Figure 4 displays the results when the input of the EV kit are shorted to ground using jumpers JU1 and JU2. See Table 1 for placement of shunt positions.

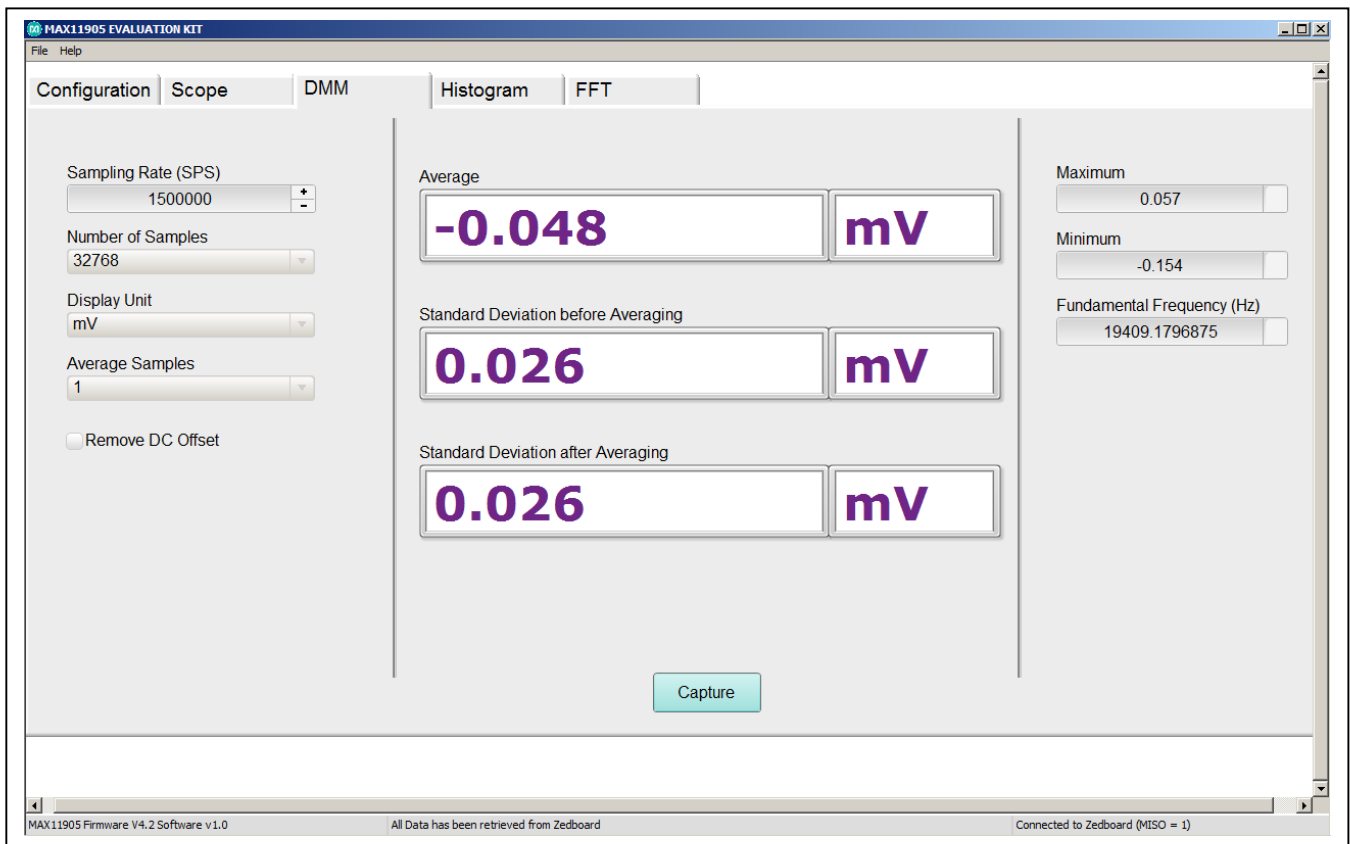

Figure 3. MAX11905 EV Kit Main Window (DMM Tab)

**FFT Tab**

The **FFT** tab sheet (Figure 6) is used to display the FFT of the data. Sampling rate and number of samples can also be set in this tab if they were not adjusted appropriately in other tabs. When coherent sampling is needed, this tab sheet allows the user to calculate the input frequency or the master clock coming into the board. Either adjust the input frequency applied to the signal generator or adjust the master clock applied to the DCLK\_IN SMA connector. See the *Sync Input and Sync Output* section before using this feature. Once the desired configuration is set, click on the **Capture** button. The right side of the tab sheet displays the performance based on the FFT, such as fundamental frequency, THD, SNR, SINAD, SFDR, ENOB, and noise floor.

Figure 5 is the setup Maxim uses to capture data for coherent sampling.

The input signal from the signal generator must be exactly **10000.000000 Hz**. The low-jitter clock is synchronized with the signal generator. The master clock is initially set to **100000000 Hz**. To achieve coherent sampling, the user must click on the **Calculate** button and use the **Adjusted(Hz)** frequency. **99523158.694 Hz** was entered into our low-jitter clock. The master clock is fed back to the ZedBoard and multiplied by 3/2, then generates a system clock that drives the Xilinx FPGA. All SPI timing and sampling rate are based off the system clock.

**Note:** If the results do not look similar to Figure 6 and more similar to Figure 7, then check all connections in Figure 5 to make sure the setup is synchronizing properly.

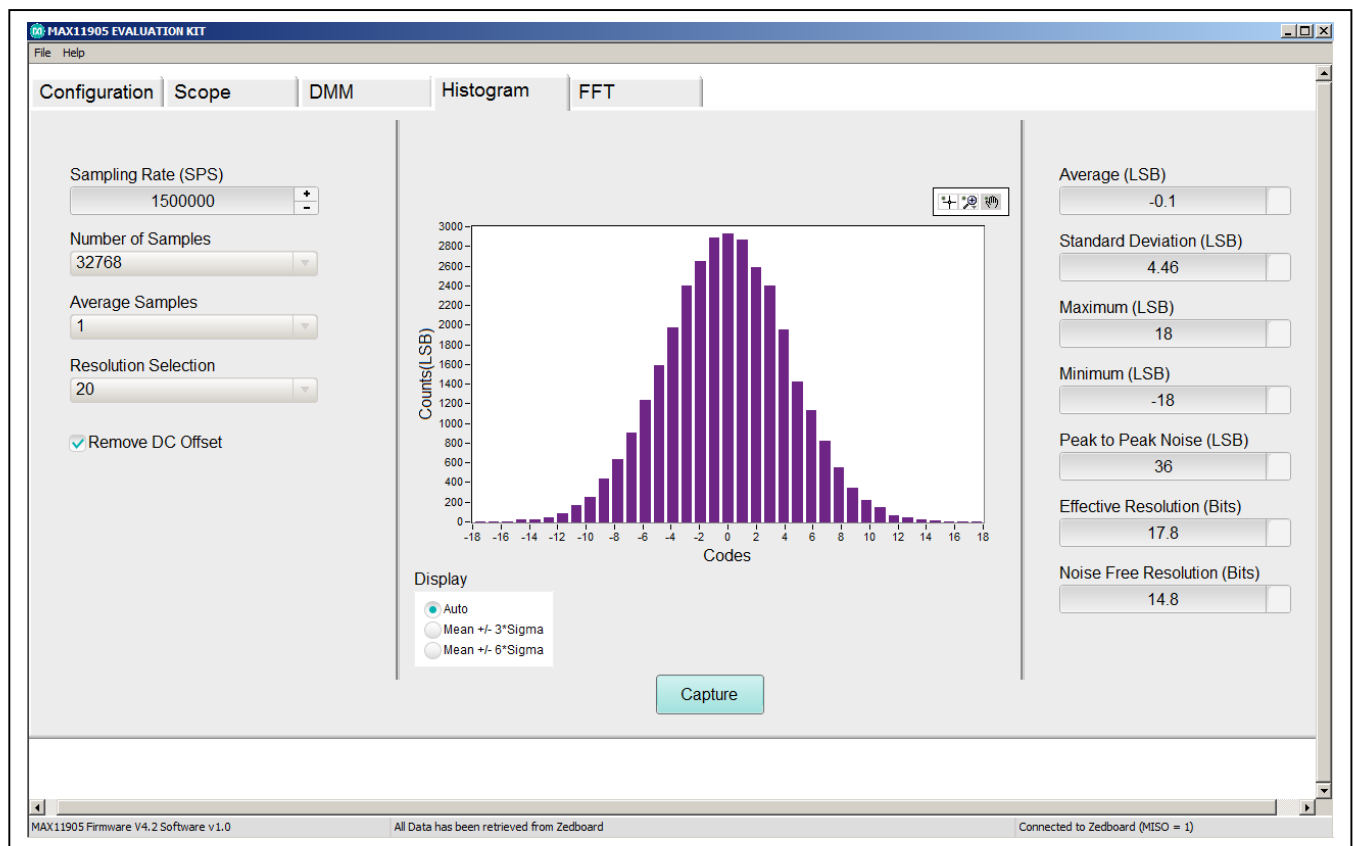

Figure 4. MAX11905 EV Kit Main Window (Histogram Tab)

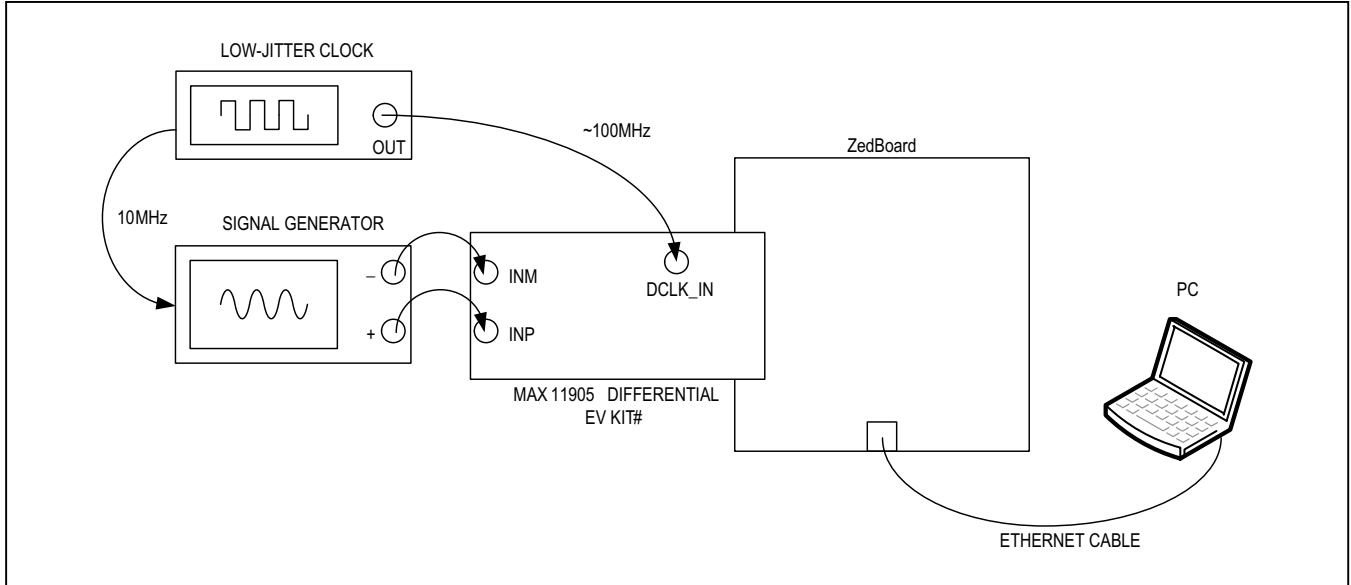

Figure 5. MAX11905 Differential EV Kit Coherent Sampling Setup

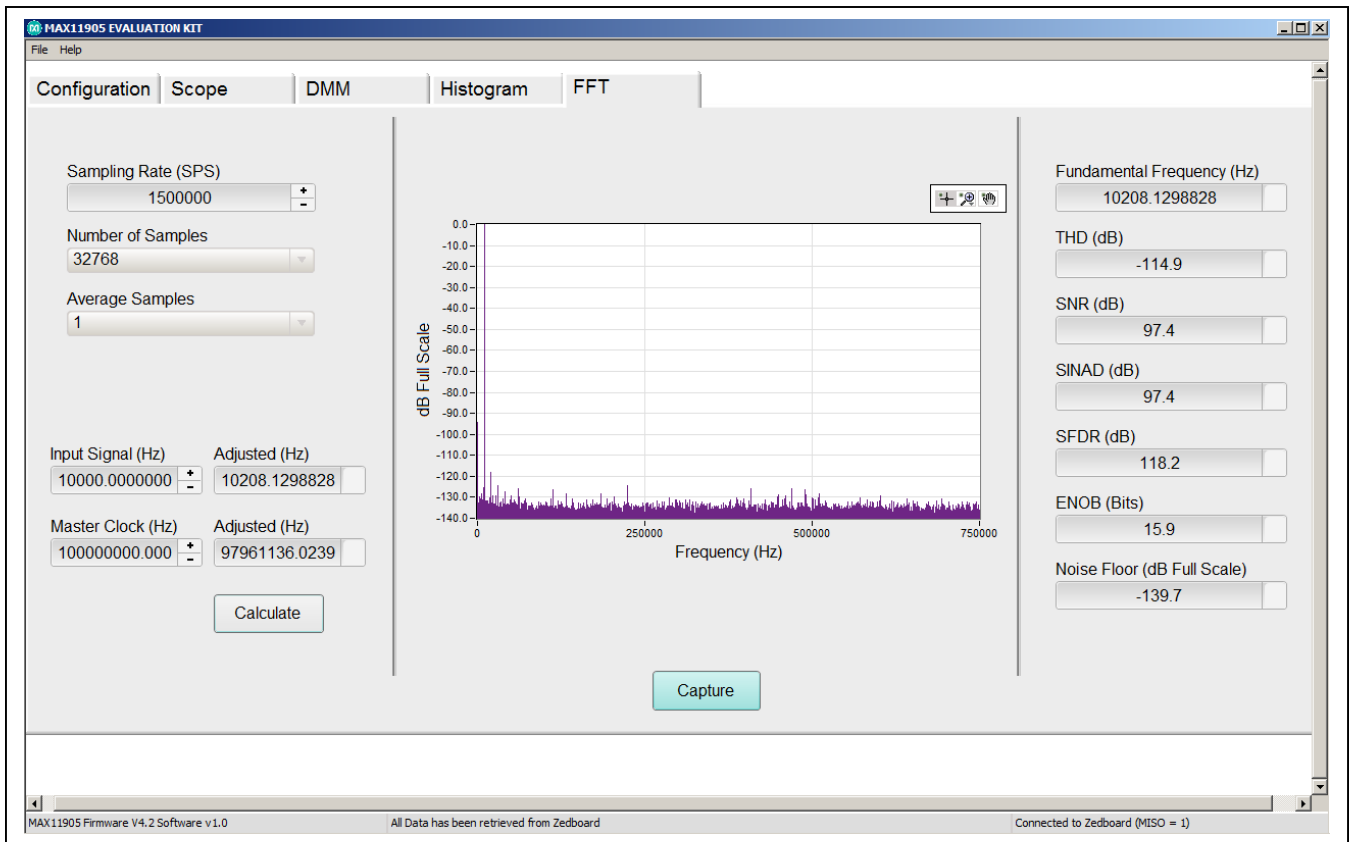

Figure 6. MAX11905 EV Kit Main Window, Coherent Sampling Results (FFT Tab)



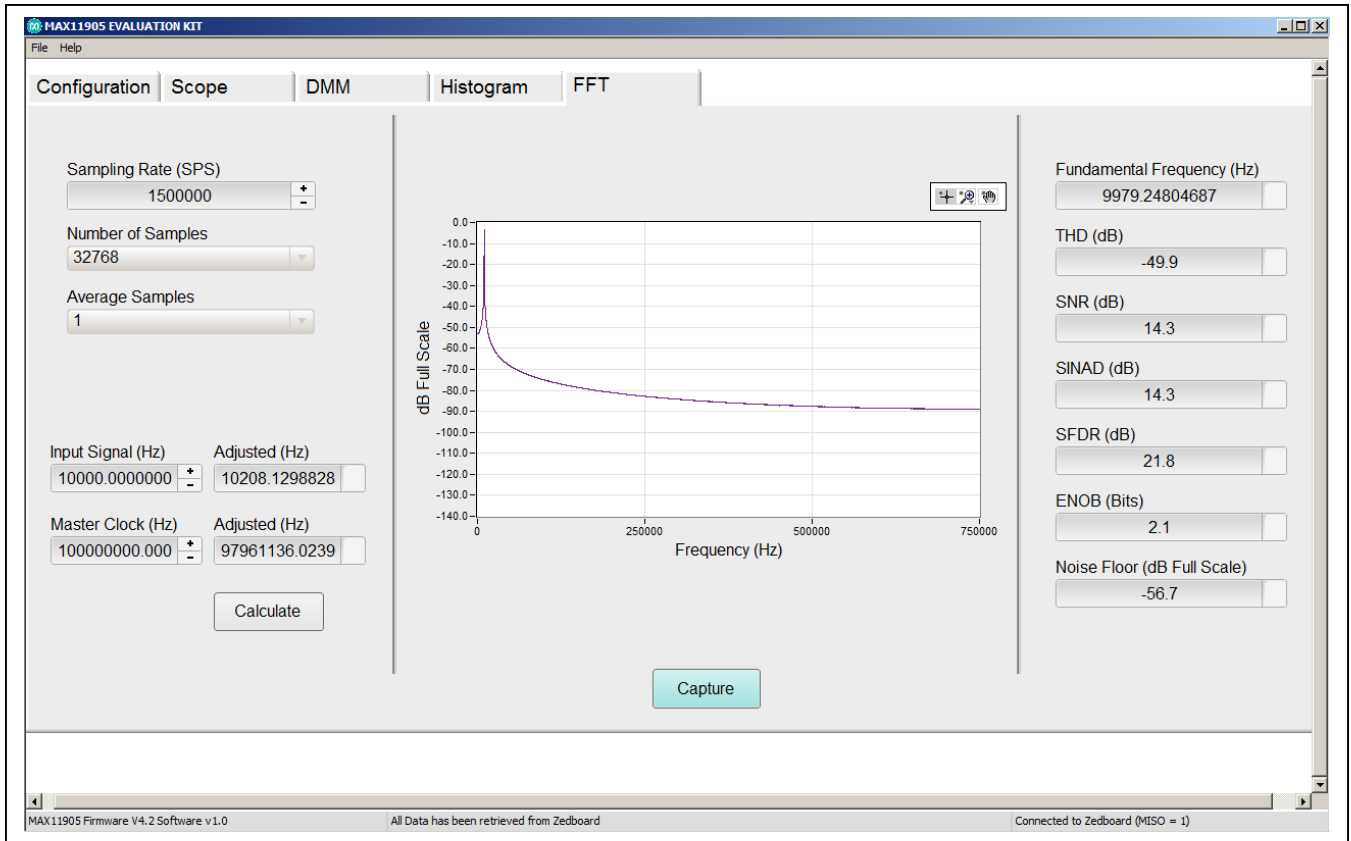

Figure 7. MAX11905 EV Kit Main Window, Noncoherent Sampling Results (FFT Tab)

## General Description of Hardware

The EV kit provides a proven layout to demonstrate the performance of the MAX11905 20-bit SAR ADC. Included in the EV kit are digital isolators, ultra-low-noise LDOs (MAX8510) to all supply pins of the IC, on-board reference (MAX6126), fully differential amplifier (MAX44205) for the analog inputs, and sync-in and sync-out signals for coherent sampling.

### Configuring the MAX44205

Jumpers are included to configure the MAX44205 appropriately. Jumper JU14 shut downs the MAX44205 by placing a shunt in the 2-3 position. Jumper JU11 is used to set the input common-mode voltage to REF/2. Jumper JU3 is used to set the output common-mode voltage to REF/2 by placing a shunt in the 1-2 position. Jumpers JU12 and JU13 are used to set the voltage clamps to protect the analog inputs of the MAX11905 ADC. The default position connects VCLPH to REFVDD and VCLPL to GND.

### User-Supplied SPI

To evaluate the EV kit with a user-supplied SPI bus, remove shunts from jumper JU9. Apply the user-supplied SPI signals to the SCLK, CNVST, DIN, and DOUT test points. Make sure the return ground is the same as the IC's ground.

### User-Supplied REFVDD

The REFVDD supply is powered through a +3.3V LDO by default. For user-supplied REFVDD, remove the shunt on jumper JU8 and apply +2.7V to +3.6V at JU8-1.

### User-Supplied AVDD

The AVDD supply is powered through a +1.8V LDO by default. For user-supplied AVDD, remove the shunt on jumper JU7 and apply +1.7V to +1.9V at JU7-2.

### User-Supplied DVDD

The DVDD supply is powered through a +1.8V LDO by default. For user-supplied DVDD, remove the shunt on jumper JU4 and apply +1.7V to +1.9V at JU4-2.

### User-Supplied OVDD

The OVDD supply is powered through a +3.3V LDO by default. For user-supplied OVDD, remove the shunt on jumper JU6 and apply +1.5V to +3.6V at JU6-2. Since

there is a supply limitation on the isolators (U3, U18), the OVDD supply should not be powered below +2.7V when the FMC connector or PMOD of the EV kit are being used.

### User-Supplied REFIN

The IC uses an on-board +3V reference (MAX6126) by default. For user-supplied REFIN, move the shunt on jumper JU5 to the 2-3 position. Make sure that REFIN is 300mV below REFVDD before applying the reference.

### Analog Inputs

Both analog inputs (AIN+ and AIN-) range from 0 to  $V_{REF}$ . The differential input range is from  $-V_{REF}$  to  $+V_{REF}$  and the full-scale range is 2x the  $V_{REF}$ . The desired input signals are applied at the INP and INM SMAs or test points.

### Sync Input and Sync Output

The DCLK\_IN SMA accepts an approximate 100MHz waveform signal to generate the system clock of the ZedBoard. For maximum performance, use a low-jitter clock that syncs to the user's analog function generator. The SYNC\_OUT SMA outputs a 10MHz square waveform that syncs to the user's analog function generator. Both options are used for coherent sampling of the IC. Only one option should be used at a time. The relationship between  $f_{IN}$ ,  $f_S$ ,  $N_{CYCLES}$ , and  $M_{SAMPLES}$  is given as follows:

$$\frac{f_{IN}}{f_S} = \frac{N_{CYCLES}}{M_{SAMPLES}}$$

where:

$f_{IN}$  = Input frequency

$f_S$  = Sampling frequency

$N_{CYCLES}$  = Prime number of cycles in the sampled set

$M_{SAMPLES}$  = Total number of samples

### Interface Connectors

The EV kit and ZedBoard communicate in two ways, using the peripheral module connector (J1) or the FMC connector (J2) on the EV kit. The maximum SPI SCLK frequency is 37.5MHz for the peripheral module connector and 75MHz for the FMC connector.

MAX11905 Differential EV Kit Bill of Materials

ITEM	QTY	REF DES	MFG PART #	MFG	VALUE	DESCRIPTION
1	2	+5V, +3.3V_Z	5005	KEYSTONE	N/A	TEST POINT; PIN DIA=0.125IN; TOTAL LENGTH=0.35IN; BOARD HOLE=0.063IN; RED; PHOSPHOR BRONZE WIRE SILVER PLATE FINISH; RECOMMENDED FOR BOARD THICKNESS=0.062IN
2	4	C1, C9, C26, C102	C0603C103K2RAC	KEMET	0.01UF	CAPACITOR; SMT (0603); CERAMIC CHIP; 0.01UF; 200V; TOL=10%; MODEL=; TG=-55 DEGC TO +125 DEGC; TC=X7R
3	21	C2, C3, C6, C8, C11, C13, C14, C18, C19, C23, C25, C29, C33, C34, C37, C39, C69, C94, C99, C100, C103	GRM188R72A104KA35; CC0603KRX7R0BB104	MURATA; TDK	0.1UF	CAPACITOR; SMT (0603); CERAMIC CHIP; 0.1UF; 100V; TOL=10%; TG=-55 DEGC TO +125 DEGC; TC=X7R
4	2	C4, C10	C0603X472J1GAC	KEMET	4700PF	CAPACITOR; SMT (0603); CERAMIC CHIP; 4700PF; 100V; TOL=5%; MODEL=FT-CAP; TG=-55 DEGC TO +125 DEGC; TC=C0G
5	12	C5, C7, C20, C22, C24, C28, C30, C32, C68, C70, C98, C101	C2012X5R1V106K085	TDK	10UF	CAPACITOR; SMT (0805); CERAMIC CHIP; 10UF; 35V; TOL=10%; TG=-55 DEGC TO +85 DEGC; TC=X5R
6	2	C12, C104	C0402C104J4RAC	KEMET	0.1UF	CAPACITOR; SMT; 0402; CERAMIC; 0.1uF; 16V; 5%; X7R; -55degC to + 125degC; 0 +/-15% degC MAX.
7	1	C17	C0603H102J1GAC	KEMET	1000PF	CAPACITOR; SMT (0603); CERAMIC CHIP; 1000PF; 100V; TOL=5%; MODEL=HT SERIES; TG=-55 DEGC TO +200 DEGC; TC=C0G
8	4	C31, C50, C51, C67	GRM32ER72A225KA35; CGA6N3XR2A225K230	MURATA/TK	2.2UF	CAPACITOR; SMT (1210); CERAMIC CHIP; 2.2UF; 100V; TOL=10%; MODEL=GRM SERIES; TG=-55 DEGC to +125 DEGC; TC=X7R
9	5	C35, C36, C38, C93, C95	UMK107B1105KA-T; C1608X5R1H105K080AB; CL10A105KB8NNN; GRM188R61H105KAAL	TAIYO YUDEN; TDK; SAMSUNG; MURATA	1UF	CAPACITOR; SMT (0603); CERAMIC CHIP; 1UF; 50V; TOL=10%; MODEL=_MK SERIES; TG=-55 DEGC TO +85 DEGC
10	8	C40, C41, C46, C47, C106, C109, C113, C116	C0603C104K3RAC; GRM188R71E104KA01; C1608X7R1E104K	KEMET/MURATA/T DK	0.1UF	CAPACITOR; SMT; 0603; CERAMIC; 0.1uF; 25V; 10%; X7R; -55degC to + 125degC; +/-15% from - 55degC to +125degC; NOT RECOMMENDED FOR NEW DESIGN USE - 20-000u1-01
11	8	C42-C45, C105, C107, C111, C115	GRM31CR71E106KA12L; CL31B106KAHNNN	MURATA; SAMSUNG ELECTRONICS	10UF	CAPACITOR; SMT (1206); CERAMIC CHIP; 10UF; 25V; TOL=10%; TG=-55 DEGC TO +125 DEGC; TC=X7R
12	4	INM, INP, DCLK_IN, SYNC_OUT	5-1814832-1	TYCO	5-1814832-1	CONNECTOR; FEMALE; THROUGH HOLE; CONN SOCKET SMA STR DIE CAST PCB; STRAIGHT; 5PINS

MAX11905 Differential EV Kit Bill of Materials (continued)

13	9	GND1-GND6, GND1-1- GND3	5001	KEYSTONE	N/A	TEST POINT; PIN DIA=0.1IN; TOTAL LENGTH=0.3IN; BOARD HOLE=0.04IN; BLACK; PHOSPHOR BRONZE WIRE SILVER PLATE FINISH; RECOMMENDED FOR BOARD THICKNESS=0.062IN; NOT FOR COLD TEST
14	1	GND_ +5	5006	KEYSTONE	N/A	TEST POINT; PIN DIA=0.125IN; TOTAL LENGTH=0.35IN; BOARD HOLE=0.063IN; BLACK; PHOSPHOR BRONZE WIRE SILVER PLATE FINISH; RECOMMENDED FOR BOARD THICKNESS=0.062IN; NOT FOR COLD TEST
15	5	VS+, VS-, INM1, INP1, TP_VOCM	5010 ?			TESTPOINT WITH 1.80MM HOLE DIA, RED, MULTIPURPOSE
16	1	J1	TSW-106-08-S-D-RA	SAMTEC	TSW-106-08-S-D-RA	CONNECTOR; THROUGH HOLE; DOUBLE ROW; RIGHT ANGLE; 12PINS; THIS PART IS DEDICATED FOR PMOD PERIPHERAL BOARD
17	1	J2	ASP-134604-01	SAMTEC	ASP-134604-01	CONNECTOR; MALE; SMT; HIGH SPEED/HIGH DENSITY OPEN PIN FIELD TERMINAL ARRAY; STRAIGHT; 160PINS
18	3	JU1, JU2, JU11	PEC02SAAN	SULLINS	PEC02SAAN	CONNECTOR; MALE; THROUGH HOLE; BREAKAWAY; STRAIGHT; 2PINS
19	6	JU3, JU5, JU6, JU12-JU14	PCC03SAAN	SULLINS	PCC03SAAN	CONNECTOR; MALE; THROUGH HOLE; BREAKAWAY; STRAIGHT THROUGH; 3PINS; -65 DEGC TO +125 DEGC
20	1	JU9	TSW-104-26-T-T	SAMTEC	TSW-104-26-T-T	CONNECTOR; MALE; THROUGH HOLE; TSW SERIES; TRIPLE ROW; 2.54MM PITCH; STRAIGHT; 12PINS
21	2	R1, R2	RG1608N-101-W-T1	SUSUMU CO LTD.	100	RESISTOR; 0603; 100 OHM; 0.05%; 10PPM; 0.10W; THICK FILM
22	4	R3, R6, R16, R19	CRCW06030000ZS; MCR03EZPJ000; ERJ-3GEY0R00	VISHAY DALE/ROHM/PANASONIC	0	RESISTOR; 0603; 0 OHM; 0%; JUMPER; 0.10W; THICK FILM
23	9	R4, R5, R14, R15, R17, R18, R39, R42, R44	SEE NOTES	VISHAY DALE	33	RESISTOR; 0603; 33 OHM; 1%; 100PPM; 0.10W; THICK FILM
24	4	R8, R9, R45, R49	RN73C1J2K0B; 5-1614352-1	TE CONNECTIVITY	2K	RESISTOR; 0603; 2K OHM; 0.1%; 10PPM; 0.063W; METAL FILM
25	9	R21-R24, R35-R38, R43	CRCW06031003FK; ERJ-3EKF1003	VISHAY DALE/PANASONIC	100K	RESISTOR; 0603; 100K; 1%; 100PPM; 0.10W; THICK FILM
26	5	R26, R27, R32-R34	RN73C1J10RBTG; 1614350-2	TE CONNECTIVITY	10	RESISTOR; 0603; 10 OHM; 0.1%; 10PPM; 0.063W; THICK FILM
27	2	R30, R31	288-0603-1.0K-RC	XICON	1K	RESISTOR; 0603; 1K; 0.1%; 10PPM, 1/16W, THIN FILM
28	1	R41	CRCW060349R9FK	VISHAY DALE	49.9	RESISTOR; 0603; 49.9 OHM; 1%; 100PPM; 0.10W; THICK FILM
29	2	R47, R48	RN73C1J49R9B; 9-1614353-1	TE CONNECTIVITY	49.9	RESISTOR; 0603; 49.9 OHM; 0.1%; 10PPM; 0.063W; METAL FILM

MAX11905 Differential EV Kit Bill of Materials (continued)

30	1 R51			ERJ-3GEY1J04V	PANASONIC	100K	RESISTOR; 0603; 100K OHM; 5%; 200PPM; 0.10W; THICK FILM
31	2 R52, R53			RN73C1E1K0B	TE CONNECTIVITY	1K	RESISTOR; 0402; 1K OHM; 0.1%; 10PPM; 0.063W ; THIN FILM
32	17 SU1-SU17			STC02SYAN	SULLINS ELECTRONICS CORP.	STC02SYAN N	TEST POINT; JUMPER; STR; TOTAL LENGTH=0.256IN; BLACK; INSULATION=PBT CONTACT=PHOSPHOR BRONZE; COPPER PLATED TIN OVERALL
33	4 TP2-TP5		5011 ?			5011	TEST POINT; PIN DIA=0.125IN; TOTAL LENGTH=0.445IN; BOARD HOLE=0.063IN; BLACK; PHOSPHOR BRONZE WIRE SILVER PLATE FINISH; RECOMMENDED FOR BOARD THICKNESS=0.062IN
34	1 U1			MAX11905ETP+	MAXIM	MAX11905 ETP+	IC; ADC; 20-BIT, 1.6MSPS, LOW-POWER, FULLY DIFFERENTIAL SAR ADC; TQFN20-EP 4X4
35	1 U2			MAX6126AASA30+	MAXIM	MAX6126A ASA30	SERIES VOLTAGE REFERENCE
36	2 U3, U18			MAX14935FAWE+	MAXIM	MAX14935 FAWE+	IC; DISO; FOUR-CHANNEL; 150MBPS; 5KV DIGITAL ISOLATOR; WSOIC16 300MIL
37	2 U4, U5			MAX8510EXK18	MAXIM	MAX8510E XK18	IC; VREG; ULTRA-LOW-NOISE; HIGH PSRR; LOW-DROPOUT; 0.12A LINEAR REGULATOR; SC70-5
38	2 U6, U20			MAX8510EXK33+	MAXIM	MAX8510E XK33+	IC; VREG; ULTRA-LOW-NOISE; HIGH PSRR; LOW-DROPOUT; 0.12A LINEAR REGULATOR; SC70-5
39	1 U7			MAX44205ATC+	MAXIM	MAX44205 ATC+	EVKIT PART - IC; MAX44205ATC+; TQFN12-EP 3X3; PACKAGE CODE: T1233-4; PACKAGE DWG. NO.: 21-0136
40	1 U11			MAX9632ASA+	MAXIM	MAX9632A SA+	IC; OPAMP; PRECISION, LOW-NOISE, WIDE-BAND AMPLIFIER; NSOIC8 150MIL; -40 DEGC TO +125 DEGC
41	1 U17			M25P16-VMMW6TG	MICRON TECHNOLOGY INC.	M25P16-VMMW6TG	IC; MMRY; 16MBIT; SERIAL FLASH MEMORY; 75MHZ SPI BUS INTERFACE; MSOIC8 200MIL
42	1 U21			74LVC1G126GV	NXP	74LVC1G126GV 26GV	IC; DRV; SINGLE BUS BUFFER/LINE DRIVER; 3-STATE; SOT753
43	1			MAX1190XDIF	MAXIM	PCB	PCB: MAX1190XDIF
<b>TOTAL</b>						175	
DO NOT PURCHASE (DNP)							
<b>ITEM</b>	<b>QTY</b>	<b>REF DES</b>	<b>MFG PART #</b>	<b>MANUFACTURER</b>	<b>VALUE</b>	<b>DESCRIPTION</b>	
1	2	C15, C16	N/A	N/A	OPEN	PACKAGE OUTLINE 0603 NON-POLAR CAPACITOR - EVKIT	
2	1	C21	N/A	N/A	OPEN	PACKAGE OUTLINE 1206 NON-POLAR CAPACITOR - EVKIT	

MAX11905 Differential EV Kit Bill of Materials (continued)

3	1 C27	N/A	N/A	OPEN	PACKAGE OUTLINE 0805 NON-POLAR CAPACITOR - EVKIT
4	1 R7	N/A	N/A	OPEN	PACKAGE OUTLINE 0603 RESISTOR - EVKIT
5	1 R20	N/A	N/A	OPEN	PACKAGE OUTLINE 0603 RESISTOR - EVKIT
<b>TOTAL</b>	6				
PACKOUT (These are purchased parts but not assembled on PCB and will be shipped with PCB)					
<b>ITEM</b>	<b>QTY</b>	<b>REF DES</b>	<b>MFG</b>	<b>VALUE</b>	<b>DESCRIPTION</b>
1	1	PACKOUT	N/A	?	BOX:SMALL BROWN 9 3/16X7X1 1/4 - PACKOUT
2	1	PACKOUT	N/A	?	ESD BAG:BAG:STATIC SHIELD ZIP 4inX6in,W/ESD LOGO - PACKOUT
3	1	PACKOUT	N/A	?	PINK FOAM:FOAM:ANTI-STATIC PE 12inX12inX5MM - PACKOUT
4	1	PACKOUT	N/A	?	WEB INSTRUCTIONS FOR MAXIM DATA SHEET
5	1	PACKOUT	N/A	?	LABEL(EV KIT BOX) - PACKOUT

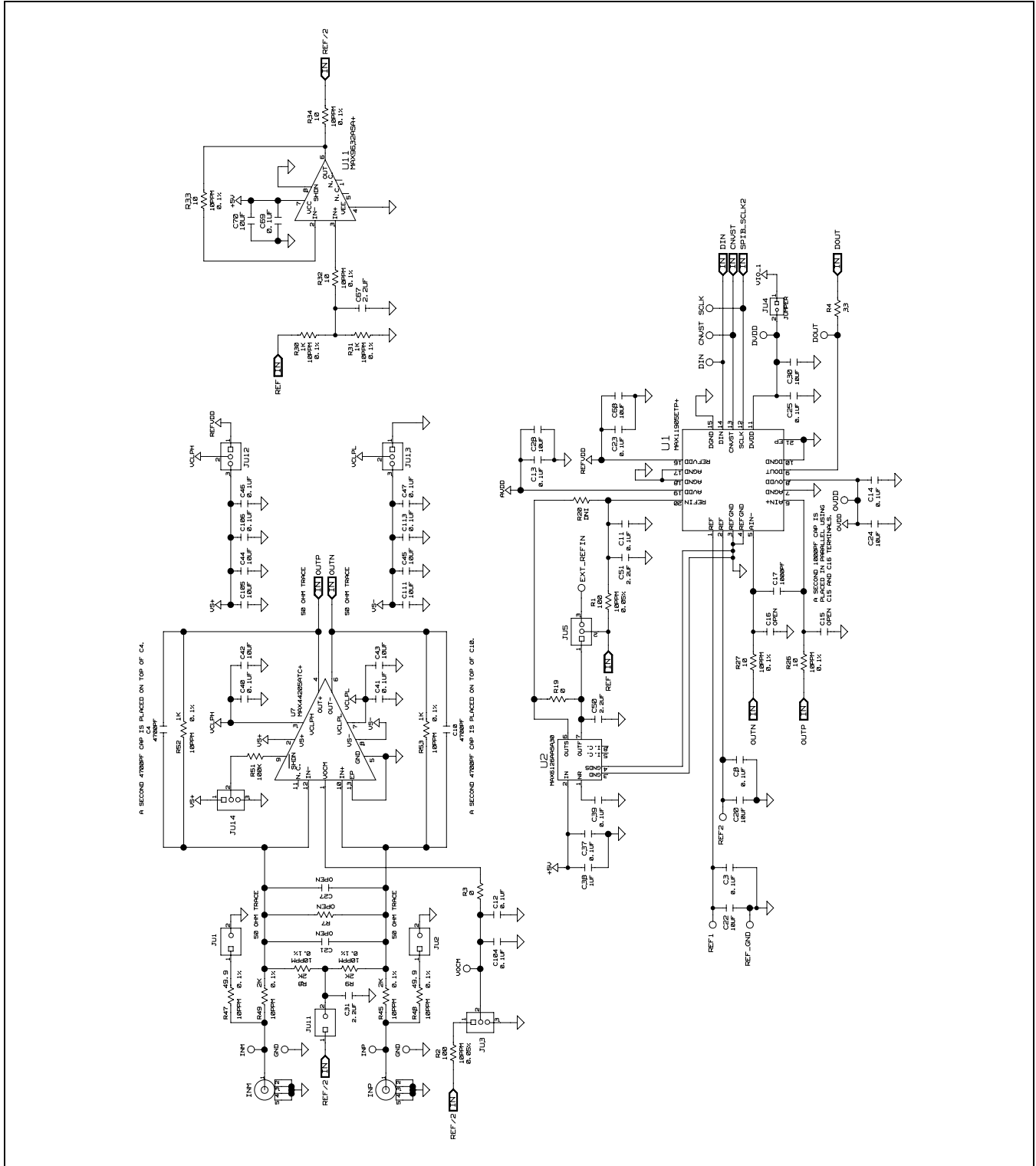

Figure 8a. MAX11905 Differential EV Kit Schematic (Sheet 1 of 3)

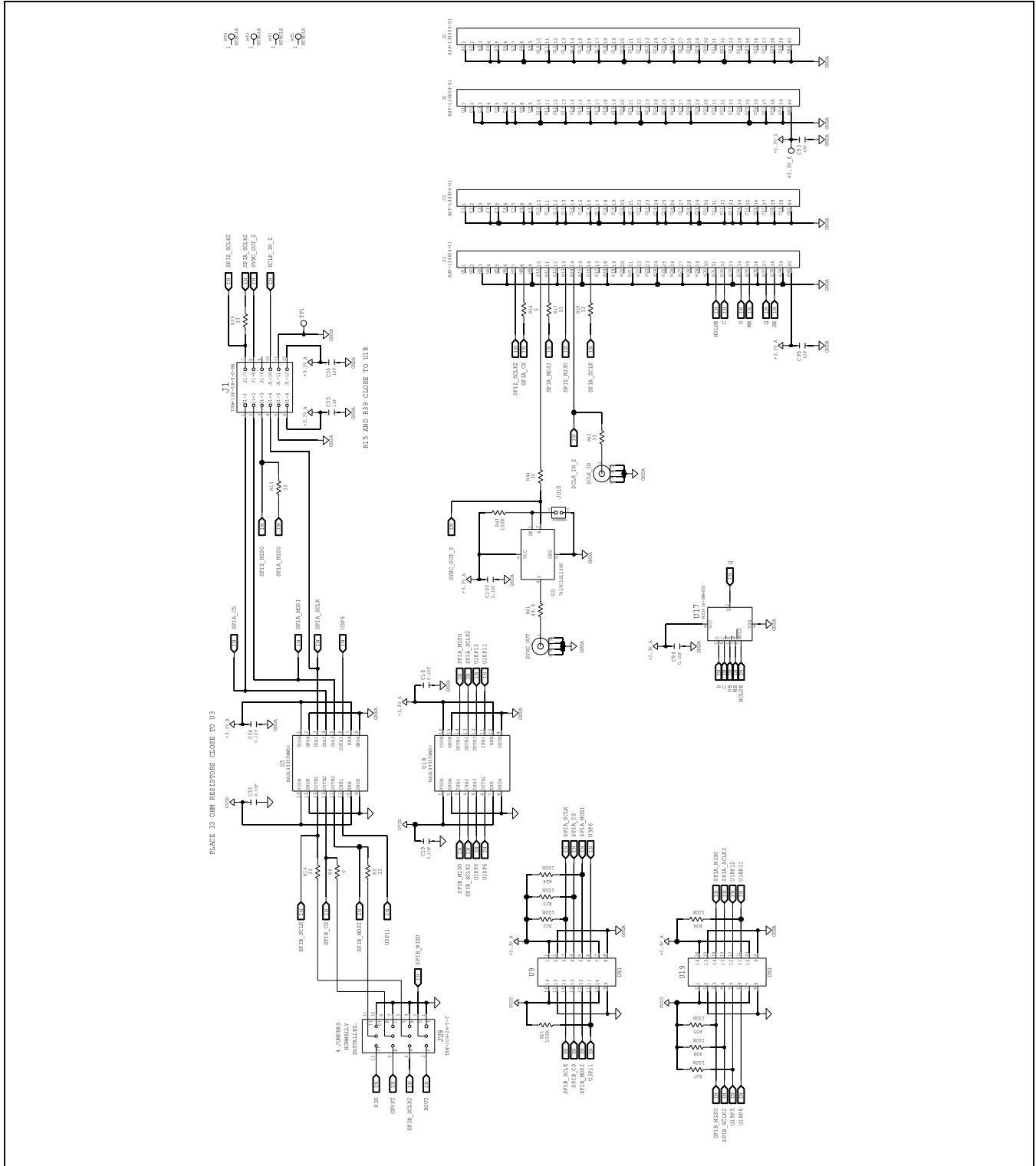

Figure 8b. MAX11905 Differential EV Kit Schematic (Sheet 2 of 3)



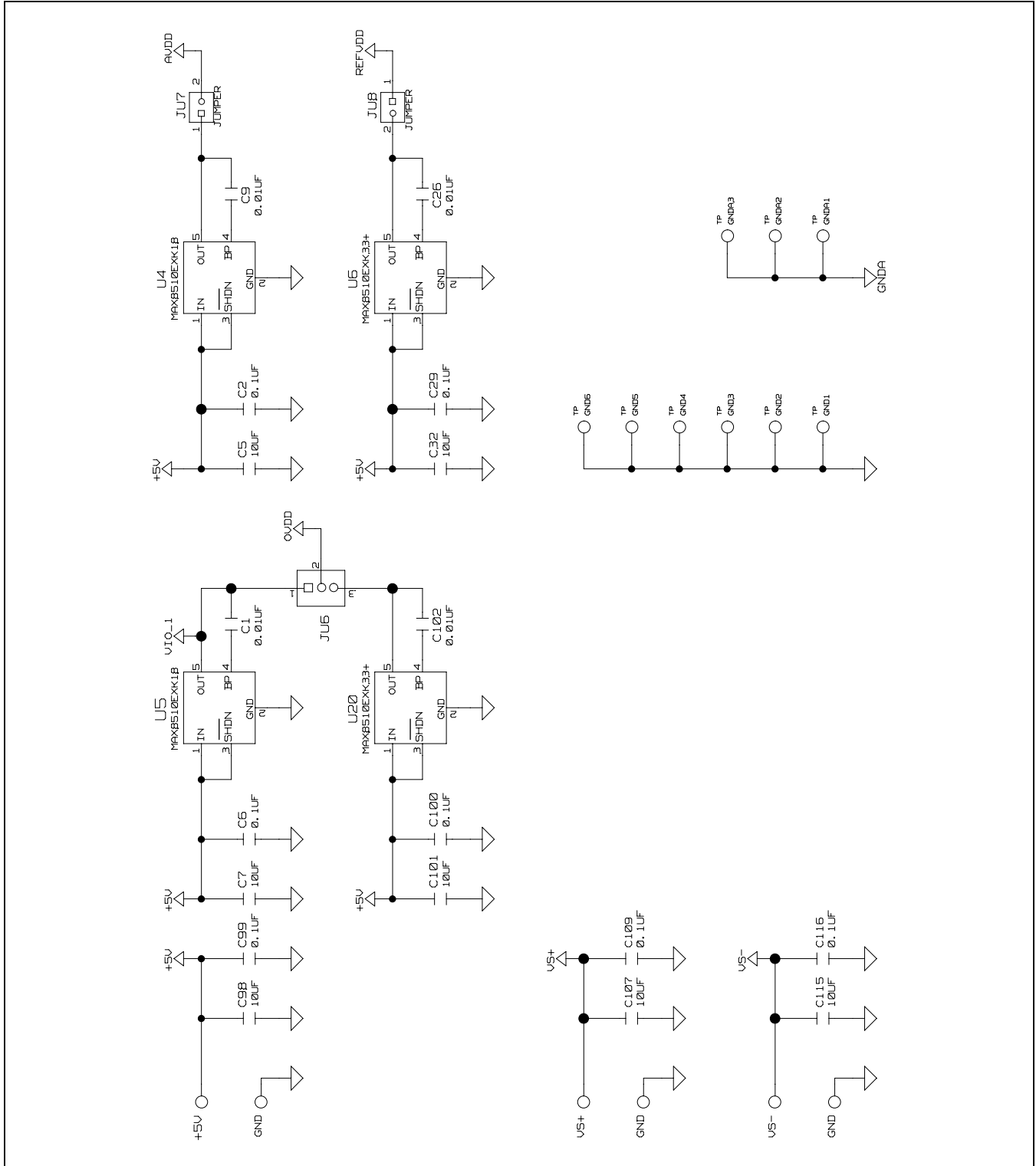

Figure 8c. MAX11905 Differential EV Kit Schematic (Sheet 3 of 3)

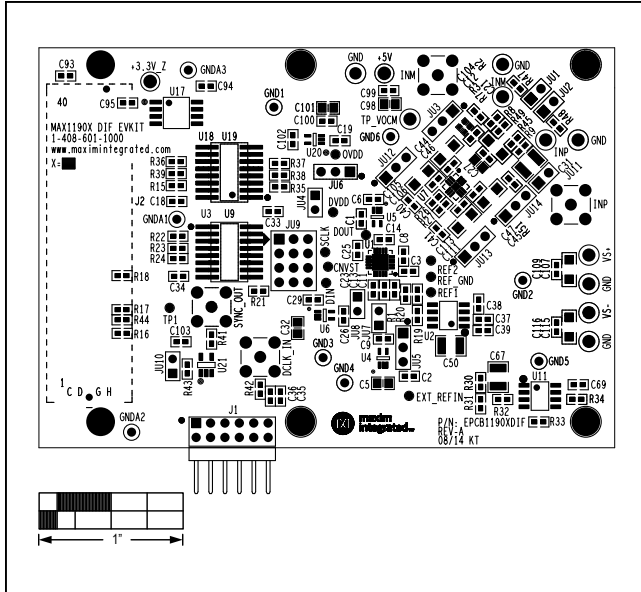

Figure 9. MAX11905 Differential EV Kit Component Placement Guide—Component Side

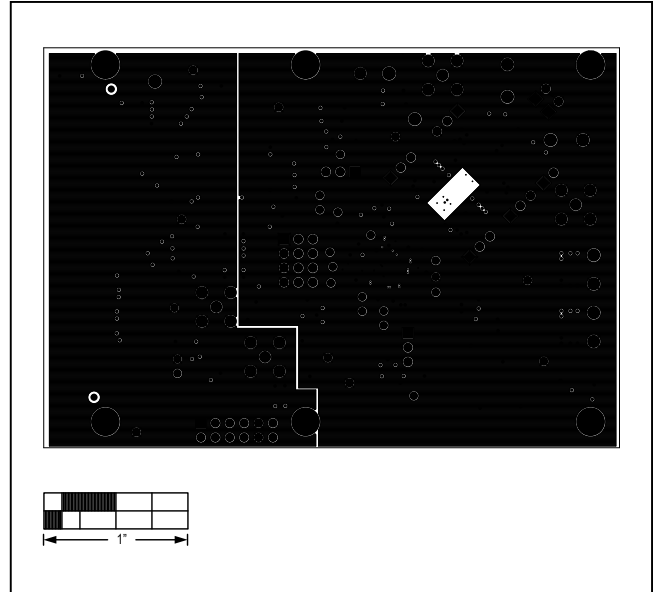

Figure 11. MAX11905 Differential EV Kit PCB Layout—Layer 2

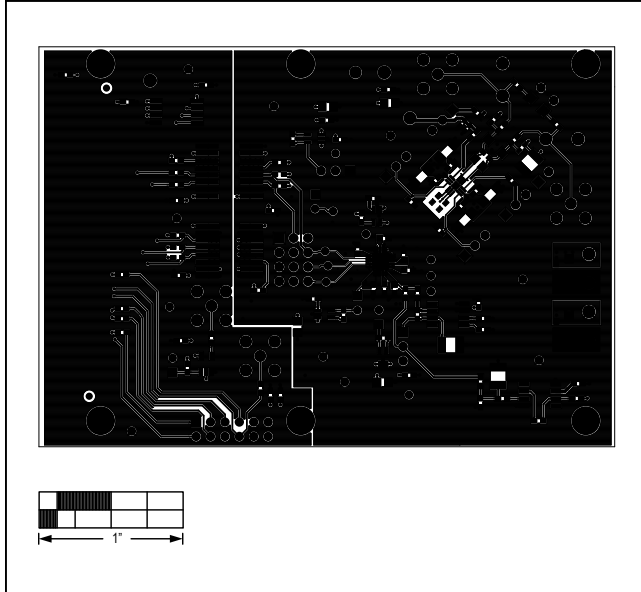

Figure 10. MAX11905 Differential EV Kit PCB Layout—Component Side

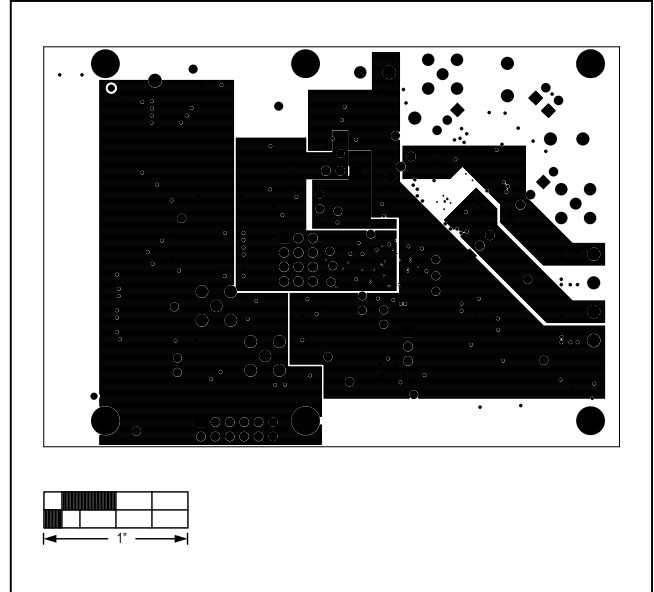

Figure 12. MAX11905 Differential EV Kit PCB Layout—Layer 3

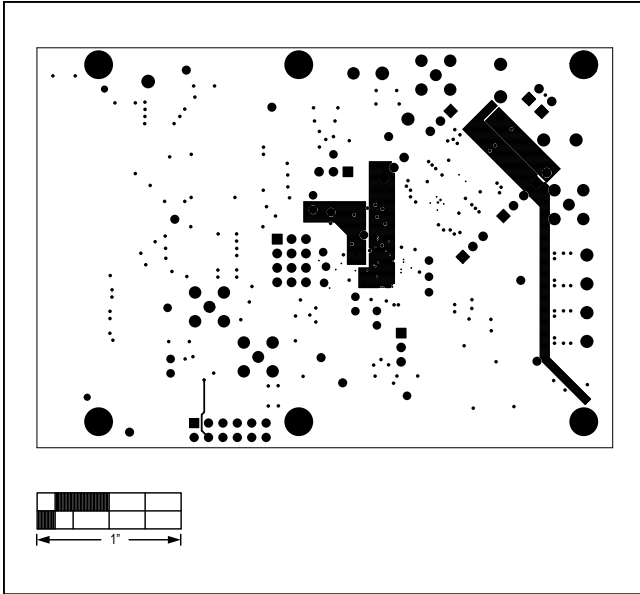

Figure 13. MAX11905 Differential EV Kit PCB Layout—Layer 4

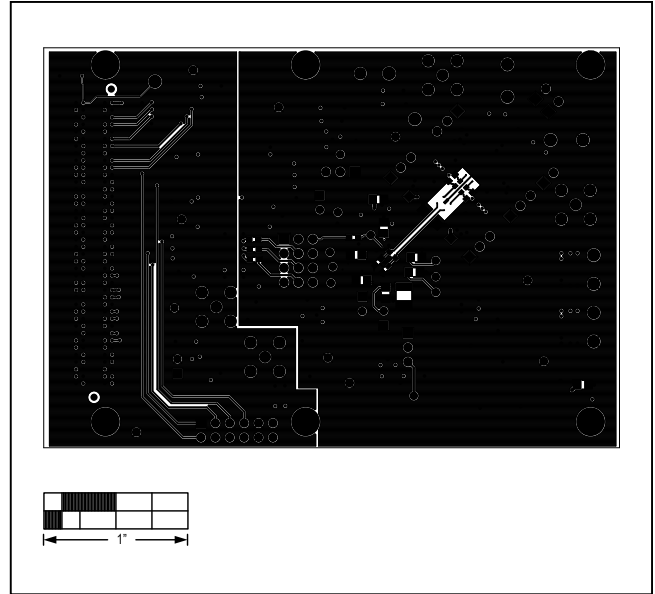

Figure 15. MAX11905 Differential EV Kit PCB Layout—Solder Side

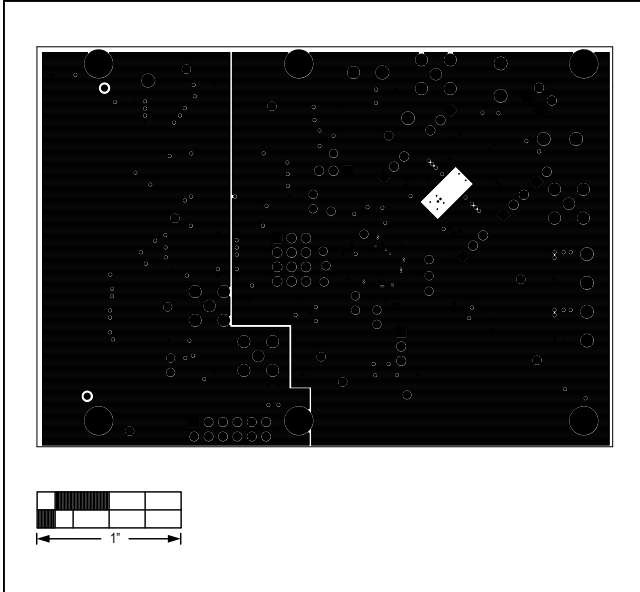

Figure 14. MAX11905 Differential EV Kit PCB Layout—Layer 5

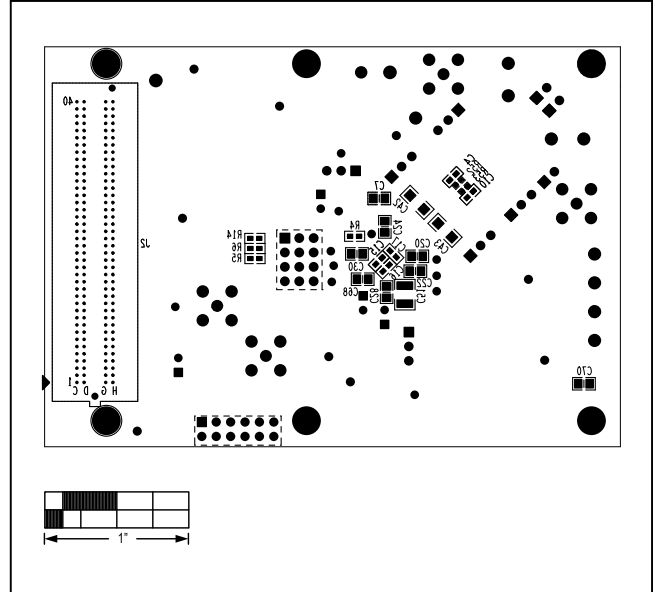

Figure 16. MAX11905 Differential EV Kit Component Placement Guide—Solder Side

### Ordering Information

PART	TYPE
MAX11905DIFEVKIT#	EV Kit

#Denotes RoHS compliant.

## Revision History

REVISION NUMBER	REVISION DATE	DESCRIPTION	PAGES CHANGED
0	12/14	Initial release	—
1	12/16	Updated second page of schematic and <i>Bill of Materials</i>	10, 12–16

For pricing, delivery, and ordering information, please contact Maxim Direct at 1-888-629-4642, or visit Maxim Integrated's website at [www.maximintegrated.com](http://www.maximintegrated.com).

*Maxim Integrated cannot assume responsibility for use of any circuitry other than circuitry entirely embodied in a Maxim Integrated product. No circuit patent licenses are implied. Maxim Integrated reserves the right to change the circuitry and specifications without notice at any time.*