

# 3M™ Pak 50 Low Profile Socket

.050" Low Profile, Right Angle Stacking Socket

P50L Series

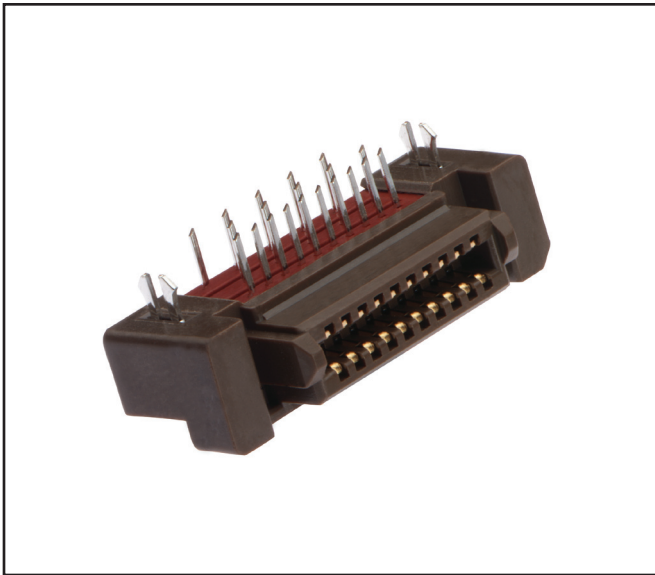

- Low profile 0.276" (7 mm) from PCB surface
- High temperature insulator compatible with IR and wave soldering
- Optional plug standoffs allow offset of mated board by 1.0 - 4.0 mm
- Retention clips stabilize connector to the board during wave soldering
- RoHS Compliant. See the Regulatory Information Appendix (RIA) in the "RoHS Compliance" section of [www.3Mconnector.com](http://www.3Mconnector.com) for compliance information (RIA E1 and C1 apply)

Date Modified: February 11, 2010

TS-1146-B  
Sheet 1 of 2

---

## Physical

### Insulator:

Material: Glass Filled PPS

Flammability: UL 94V-0

Color: Brown

Contact Material: Phosphor Bronze

### Plating:

Underplating: Nickel

Wiping Area: Gold Flash

Solder Tails: Gold Flash

Retaining Clips: Tin-Copper

Mating Compatibility: TS-1145 , TS-1161, TS-2053

---

## Electrical

**Current Rating:** 0.5 A

**Insulation Resistance:**  $> 1 \times 10^9 \Omega$  at 500 V<sub>DC</sub>

**Withstanding Voltage:** 650 V<sub>AC</sub> for 1 minute

---

## Environmental

**Temperature Rating:** -55°C to +85°C

**Process Rating:** 260°C MSL1 (per J-STD-020C)

UL File No.: E68080

---

**3M**  
Electronic Solutions Division  
Interconnect Solutions  
<http://www.3Mconnector.com>

3M is a trademark of 3M Company.  
For technical, sales or ordering information call  
**800-225-5373**

# 3M™ Pak 50 Low Profile Socket

.050" Low Profile, Right Angle Stacking Socket

P50L Series

## Product Table / Dimensions

Contact Quantity	A	B	C	D	E	F
20	25.43 [1.001]	20.32 [0.800]	17.03 [0.670]	15.43 [0.607]	11.43 [0.450]	14.23 [0.560]
30	31.78 [1.251]	26.67 [1.050]	23.38 [0.920]	21.78 [0.857]	17.78 [0.700]	20.58 [0.810]
40	38.13 [1.501]	33.02 [1.300]	29.73 [1.170]	28.13 [1.107]	24.13 [0.950]	26.93 [1.060]
50	44.48 [1.751]	39.37 [1.550]	36.08 [1.420]	34.48 [1.357]	30.48 [1.200]	33.28 [1.310]
60	50.83 [2.001]	45.72 [1.800]	42.43 [1.670]	40.83 [1.607]	36.83 [1.450]	39.63 [1.560]
80	63.53 [2.501]	58.42 [2.300]	55.13 [2.170]	53.53 [2.107]	49.53 [1.950]	52.33 [2.060]
100	76.23 [3.001]	71.12 [2.800]	67.83 [2.670]	66.23 [2.607]	62.23 [2.450]	65.03 [2.560]
120	88.93 [3.501]	83.82 [3.300]	80.53 [3.170]	78.93 [3.107]	74.93 [2.950]	77.73 [3.060]

## X-X' Cross Section

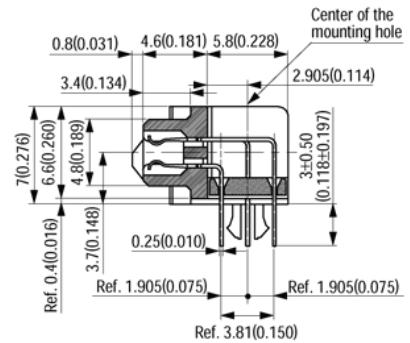

## Printed Circuit Board Layout (Component Side View)

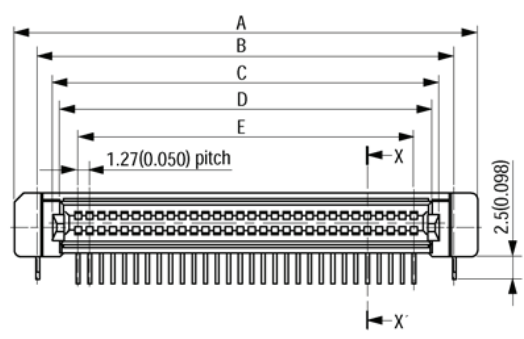
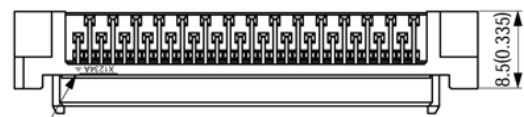
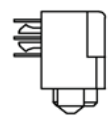
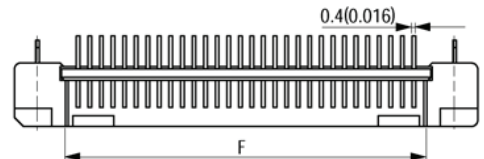
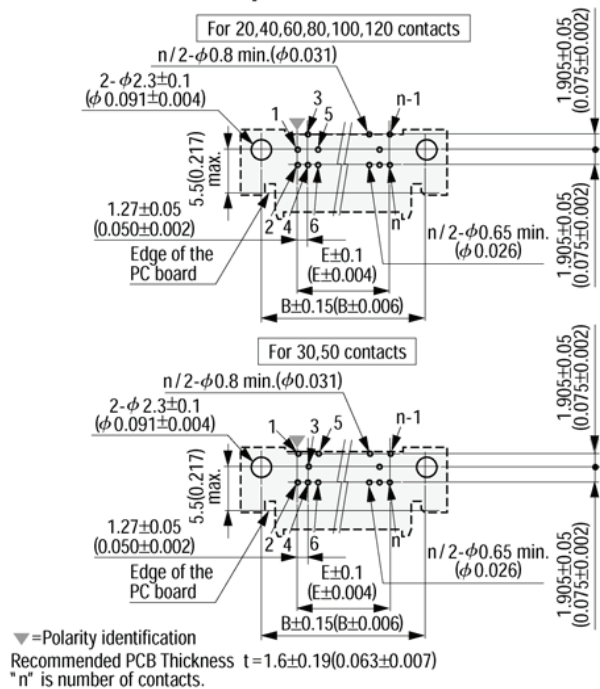

## Ordering Information

**P50L - XXXS - RR1 - DA** (RIA E1 and C1 apply)

Contact Quantity: \_\_\_\_\_  
See Table

**Important Notice**

All statements, technical information, and recommendations related to 3M's products are based on information believed to be reliable, but the accuracy or completeness is not guaranteed. Before using this product, you must evaluate it and determine if it is suitable for your intended application. You assume all risks and liability associated with such use. Any statements related to the product which are not contained in 3M's current publications, or any contrary statements contained on your purchase order shall have no force or effect unless expressly agreed upon, in writing, by an authorized officer of 3M.

**Warranty; Limited Remedy; Limited Liability.**

This product will be free from defects in material and manufacture for a period of one (1) year from the time of purchase. **3M MAKES NO OTHER WARRANTIES INCLUDING, BUT NOT LIMITED TO, ANY IMPLIED WARRANTY OF MERCHANTABILITY OR FITNESS FOR A PARTICULAR PURPOSE.** If this product is defective within the warranty period stated above, your exclusive remedy shall be, at 3M's option, to replace or repair the 3M product or refund the purchase price of the 3M product. **Except where prohibited by law, 3M will not be liable for any indirect, special, incidental or consequential loss or damage arising from this 3M product, regardless of the legal theory asserted.**

**3M Electronics Solutions Division**

6801 River Place Blvd.  
Austin, TX 78726-9000  
U.S.A.  
1-800-225-5373  
[www.3Mconnector.com](http://www.3Mconnector.com)

Please recycle. Printed in USA.  
© 3M 2010. All rights reserved.  
RIA-2217B-E

3M is a trademark of 3M Company.