















# SMD/BLOCK Type EMI Suppression Filters EMIFIL®



## Introduction

Murata Manufacturing Co., Ltd. has been developing the EMI suppression device market since the invention of 3 terminal capacitor DS310 series in 1979. Also, we have been striving to develop and popularize new noise countermeasure technologies as well as new products in the concept of "Develop unique products," to become our customer's best solution partner. We hope you can find the key solution to your noise problem.

### Explanation of symbols in this catalog

|                             | Features of each series  | Features of each item   |
|-----------------------------|--|---|
| All Products                |  <b>Flow</b> Flow soldering available                       |  <b>New</b> New product   |
|                             |  <b>Reflow</b> Reflow soldering available                   |  <b>Kit</b> Exist in design kit   |
|                             |  <b>Hi Power</b> Meets large current lines                  |  <b>≥1A</b> Rated current 1A or more  |
| Chip Ferrite Bead           |  <b>GHz</b> Meets high frequency noise up to 1-2GHz         |  <b>≥3A</b> Rated current 3A or more  |
|                             |  <b>Hi-GHz</b> Meets ultra high frequency noise up to 10GHz |  <b>≥10A</b> Rated current 10A or more  |
| LC Combined Type Filter     |  |  <b>DTV</b> Low cut-off frequency type for UHF band noise, which affects digital TV tuner     |
| Chip Common Mode Choke Coil |  |  <b>HD</b> For high speed differential signal lines (USB2.0/LVDS/IEEE1394 etc.)               |
|                             |  |  <b>UD</b> For ultra high speed differential signal lines (HDMI/DVI/Display Port/USB3.0 etc.) |
|                             |  |  <b>Imp Match</b> Line impedance has been matched to transmission lines                       |

### EU RoHS Compliant

- All the products in this catalog comply with EU RoHS.
- EU RoHS is "the European Directive 2011/65/EU on the Restriction of the Use of Certain Hazardous Substances in Electrical and Electronic Equipment."
- For more details, please refer to our website 'Murata's Approach for EU RoHS' (<http://www.murata.com/info/rohs.html>).

⚠Note • Please read rating and ⚠CAUTION (for storage, operating, rating, soldering, mounting and handling) in this catalog to prevent smoking and/or burning, etc.  
 • This catalog has only typical specifications. Therefore, please approve our product specifications or transact the approval sheet for product specifications before ordering.

# CONTENTS

|  |    |
|--|----|
| Selection Guide for Noise Suppression Filters .....        | 2  |
| EMI Filter Selection by Application .....                  | 4  |
| •Digital Still Camera .....                                | 4  |
| •Blu-ray/DVD .....   | 6  |
| •Smartphone .....  | 5  |
| •LCD-TV .....  | 7  |
| EMI Filter Selection by Circuits and Noise Frequency ..... | 8  |
| Product Guide .....  | 10 |

## BL<sub>□</sub> Chip Ferrite Bead

|                              |     |
|------------------------------|-----|
| Series Introduction .....    | 14  |
| Part Numbering .....         | 16  |
| Series Line Up .....         | 18  |
| Product Detail .....         | 24  |
| ⚠Caution/Notice .....        | 99  |
| Soldering and Mounting ..... | 100 |
| Packaging .....              | 104 |
| Design Kits .....            | 105 |

## NF<sub>□</sub> Chip EMIFIL<sup>®</sup>

|                              |     |
|------------------------------|-----|
| Series Introduction .....    | 112 |
| Part Numbering .....         | 114 |
| Series Line Up .....         | 117 |
| Product Detail .....         | 121 |
| ⚠Caution/Notice .....        | 154 |
| Soldering and Mounting ..... | 156 |
| Packaging .....              | 163 |
| Design Kits .....            | 165 |

## DL<sub>□</sub>/PL<sub>□</sub> Chip Common Mode Choke Coil

|                              |     |
|------------------------------|-----|
| Series Introduction .....    | 170 |
| Part Numbering .....         | 172 |
| Series Line Up .....         | 174 |
| Product Detail .....         | 177 |
| ⚠Caution/Notice .....        | 203 |
| Soldering and Mounting ..... | 205 |
| Packaging .....              | 212 |
| Design Kits .....            | 214 |

## BNX Block Type EMIFIL<sup>®</sup>

|                              |     |
|------------------------------|-----|
| Series Line Up .....         | 218 |
| Function Example .....       | 218 |
| Product Detail .....         | 221 |
| ⚠Caution/Notice .....        | 225 |
| Soldering and Mounting ..... | 227 |
| Packaging .....              | 231 |
| Design Kits .....            | 232 |

## EA Microwave Absorber



|                      |     |
|----------------------|-----|
| Part Numbering ..... | 234 |
| Product Detail ..... | 235 |
| Notice .....         | 238 |

|   |     |
|---|-----|
| Product Guide by Size .....   | 239 |
| Part Number Quick Reference .....   | 240 |
| Alphabetic Product Name Index .....                                       | 240 |
| Introduction of Related Catalogs .....                                    | 241 |
| Introduction of EMI/MLCC/Inductor<br>special web site "EMICON-FUN!" ..... | 242 |

⚠Note • Please read rating and ⚠CAUTION (for storage, operating, rating, soldering, mounting and handling) in this catalog to prevent smoking and/or burning, etc.  
• This catalog has only typical specifications. Therefore, please approve our product specifications or transact the approval sheet for product specifications before ordering.

# Selection Guide for Noise Suppression Filters

## ● Features & Suitable Circuits

| Type   | Features  | Suitable Circuits  |
|--|---|--|
| <b>Ferrite Bead</b><br>BLM/BLA Series<br>                       | <ul style="list-style-type: none"> <li>• Miniaturized</li> <li>• GND connection unnecessary</li> <li>• Effective at low impedance line</li> </ul>   | <ul style="list-style-type: none"> <li>• Application set with less noise radiation</li> <li>• Low impedance line</li> </ul>  |
| <b>Capacitor Type</b><br>NFM/NFA/NFE/NFR/<br>NFL/NFW Series<br> | <ul style="list-style-type: none"> <li>• Great noise suppression effect</li> <li>• With effect as By-Pass capacitor (Lineup for Power)</li> <li>• Good noise separation from signal (LC filter for Signal)</li> <li>• Effective at high impedance line</li> </ul> | <ul style="list-style-type: none"> <li>• Application set with higher noise radiation</li> <li>• High impedance line</li> <li>• Circuit with By-Pass capacitor</li> <li>• Circuit driven by high frequency</li> </ul> |
| <b>Common Mode Choke Coil</b><br>                             | <ul style="list-style-type: none"> <li>• Possible to suppress noise with less affect of ultra high speed signal</li> <li>• Great effect for common mode noise</li> <li>• Less magnetic saturation by current</li> </ul>   | <ul style="list-style-type: none"> <li>• High speed differential signal line</li> <li>• I/F cable driver</li> <li>• Power line</li> </ul>  |

## ● Example

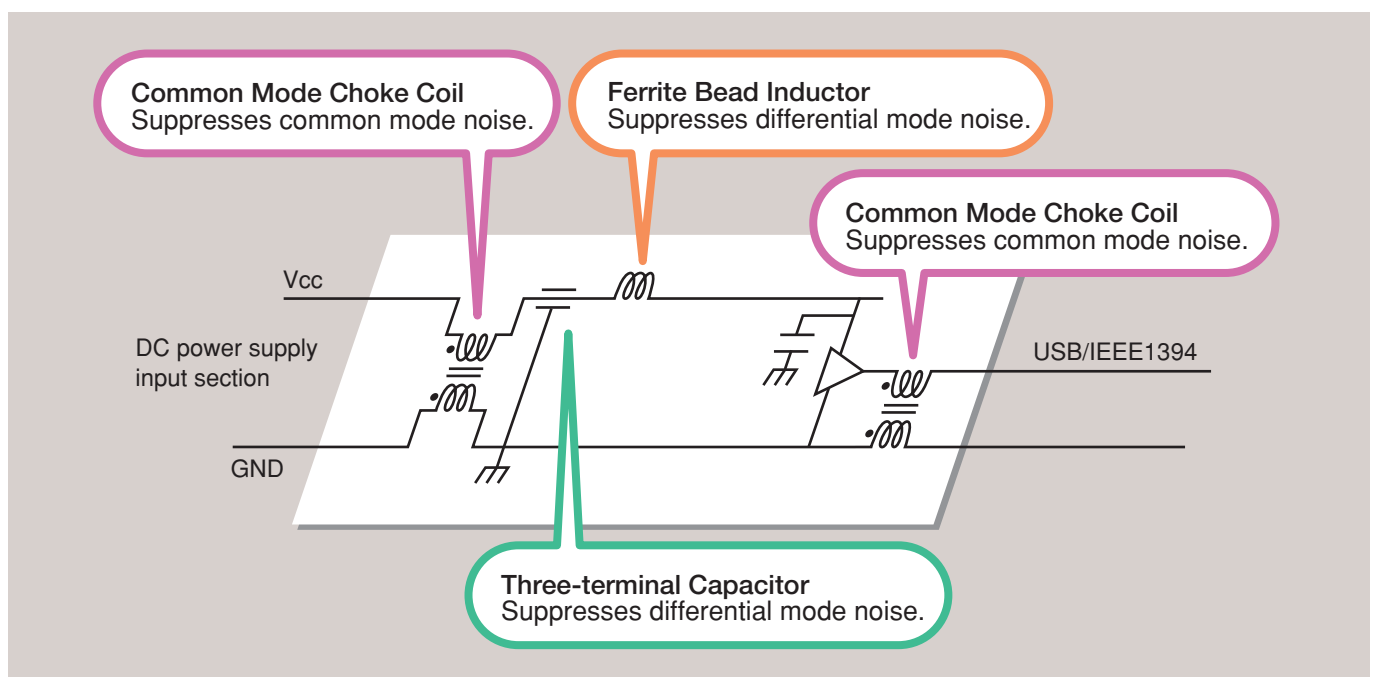

△Note • Please read rating and △CAUTION (for storage, operating, rating, soldering, mounting and handling) in this catalog to prevent smoking and/or burning, etc.  
 • This catalog has only typical specifications. Therefore, please approve our product specifications or transact the approval sheet for product specifications before ordering.

## ● Advantages to Using Common Mode Choke Coils

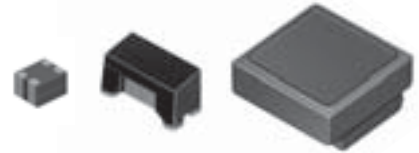

### 1. Great Effect for Common Mode Noise

Differential mode inductors work as a half impedance for common mode noise. Common Mode Choke Coils are effective for common mode noise.

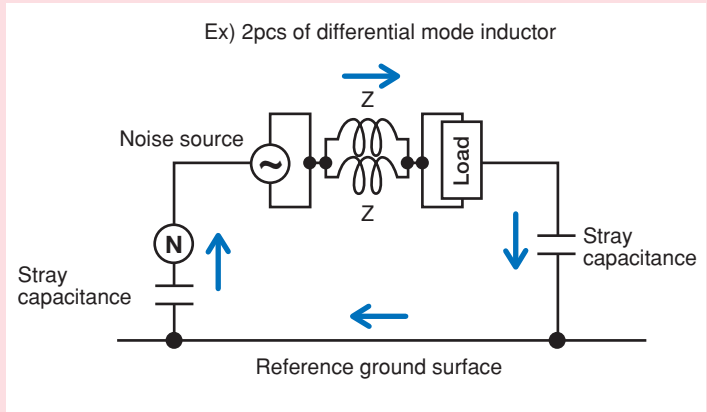

### 2. Possible to Suppress Noise with Less Affect of Ultra High Speed Signal

Common Mode Choke Coils can suppress Noise with less affect of Signal, even if the frequency range of Signal and Noise are the same, because they separate each conductive mode of current.

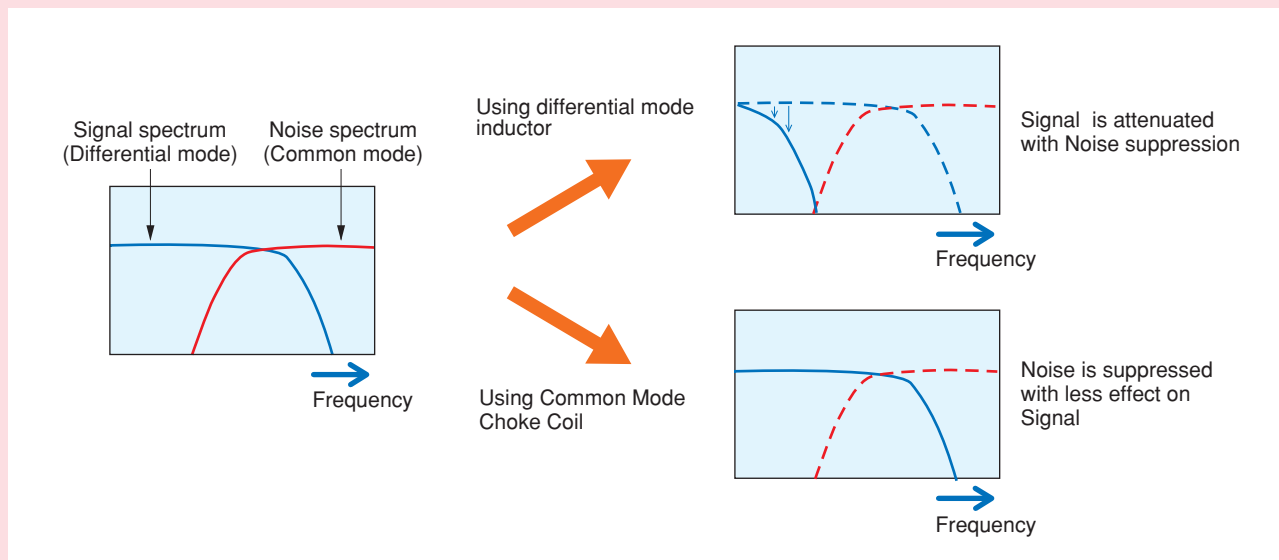

### 3. Less Magnetic Saturation by Current

Common Mode Choke Coils are effective for noise suppression of DC power lines, due to their less magnetic saturation at high power current, that comes from their construction of cancelling magnetic flux of differential mode current at each coil.

△Note • Please read rating and △CAUTION (for storage, operating, rating, soldering, mounting and handling) in this catalog to prevent smoking and/or burning, etc.  
• This catalog has only typical specifications. Therefore, please approve our product specifications or transact the approval sheet for product specifications before ordering.

## Digital Still Camera

Application Sample

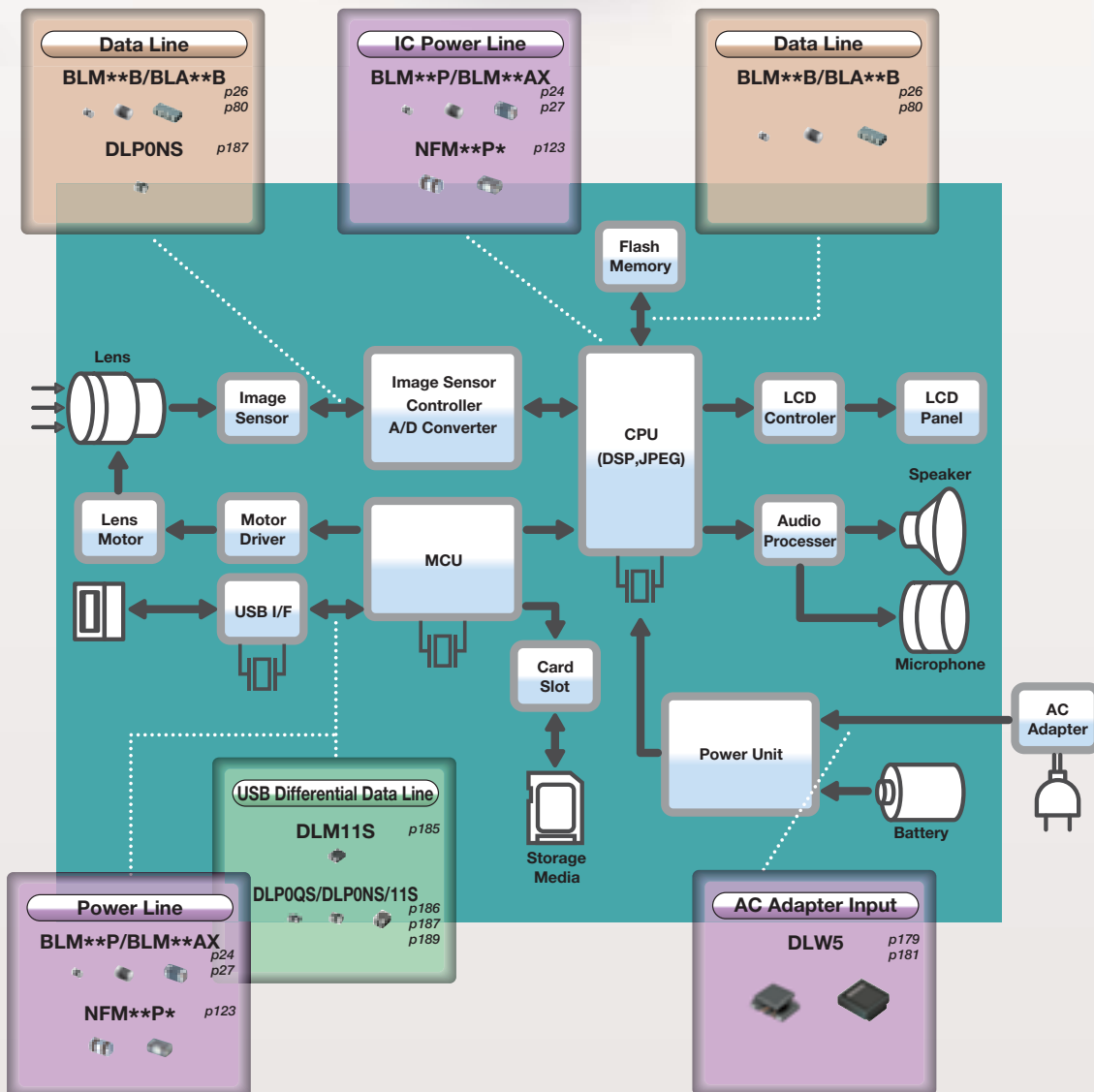
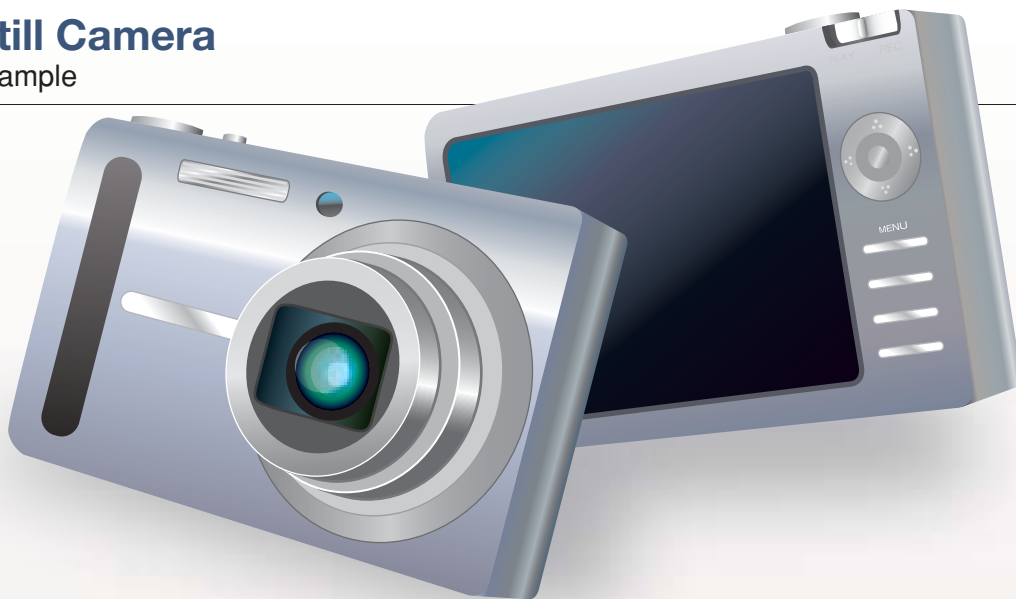

△Note • Please read rating and △CAUTION (for storage, operating, rating, soldering, mounting and handling) in this catalog to prevent smoking and/or burning, etc.  
 • This catalog has only typical specifications. Therefore, please approve our product specifications or transact the approval sheet for product specifications before ordering.

# Smartphone

Application Sample

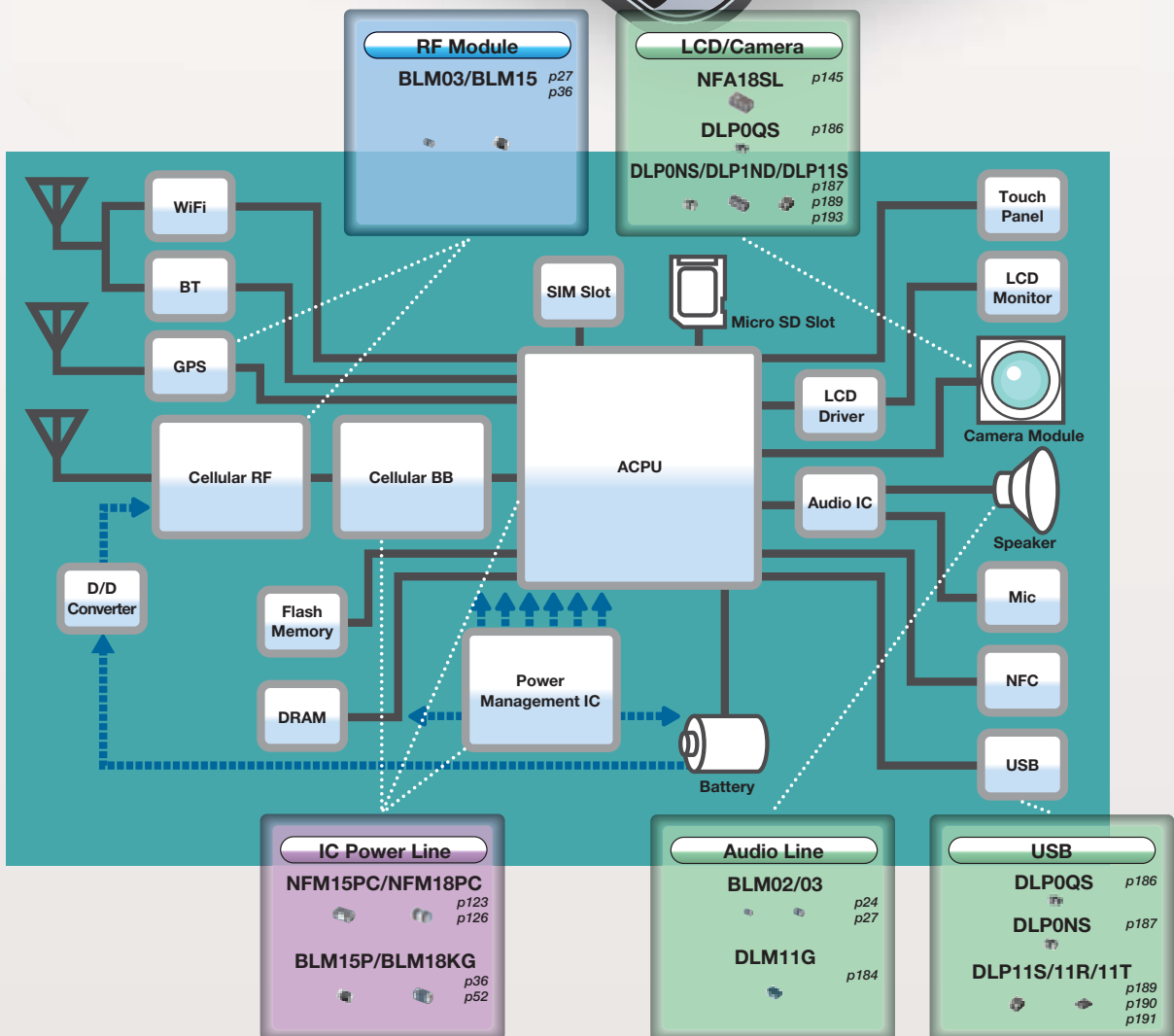

△Note • Please read rating and △CAUTION (for storage, operating, rating, soldering, mounting and handling) in this catalog to prevent smoking and/or burning, etc.  
• This catalog has only typical specifications. Therefore, please approve our product specifications or transact the approval sheet for product specifications before ordering.

# Blu-ray/DVD

Application Sample

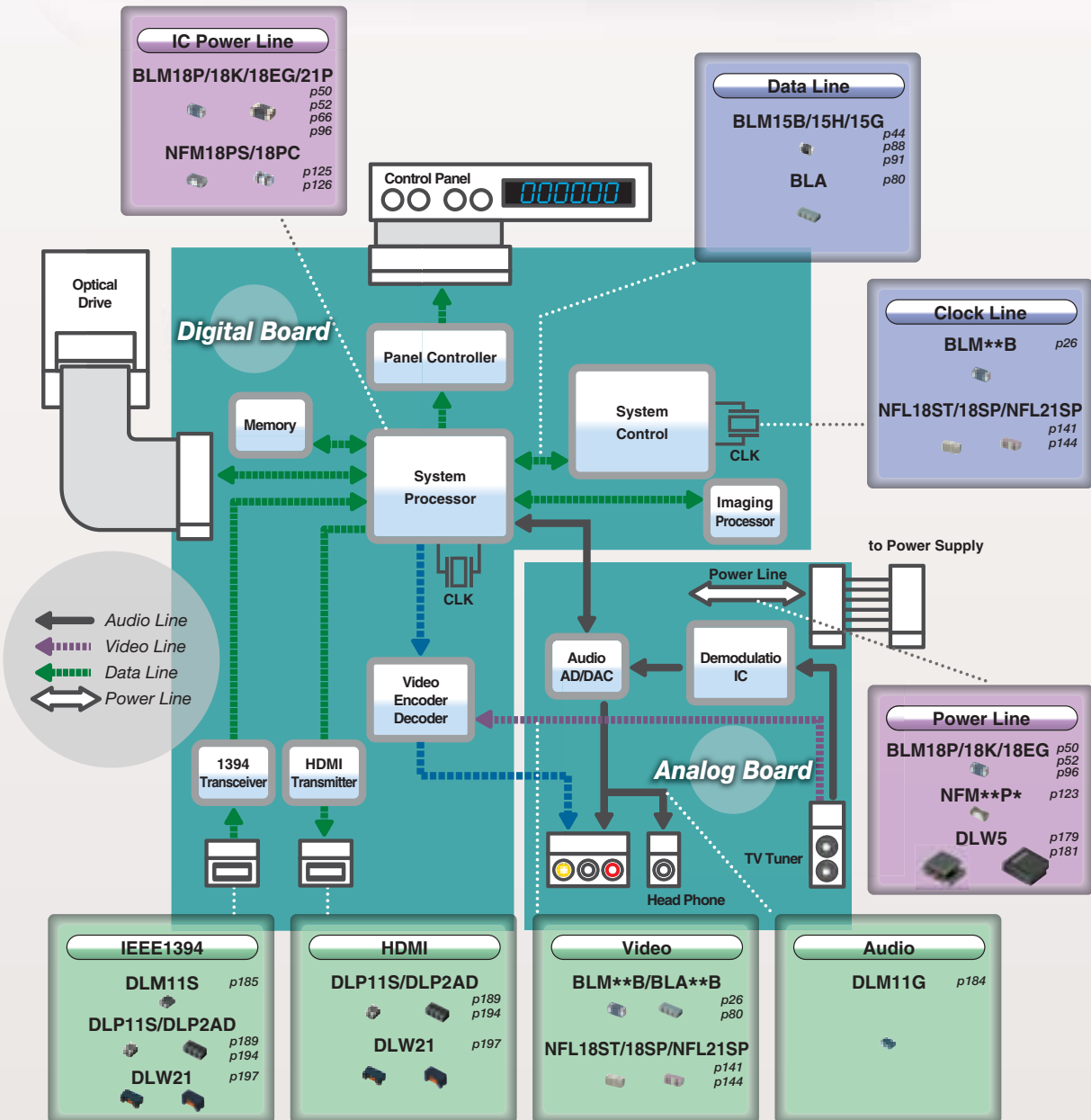

△Note • Please read rating and △CAUTION (for storage, operating, rating, soldering, mounting and handling) in this catalog to prevent smoking and/or burning, etc.  
 • This catalog has only typical specifications. Therefore, please approve our product specifications or transact the approval sheet for product specifications before ordering.



# LCD-TV

Application Sample

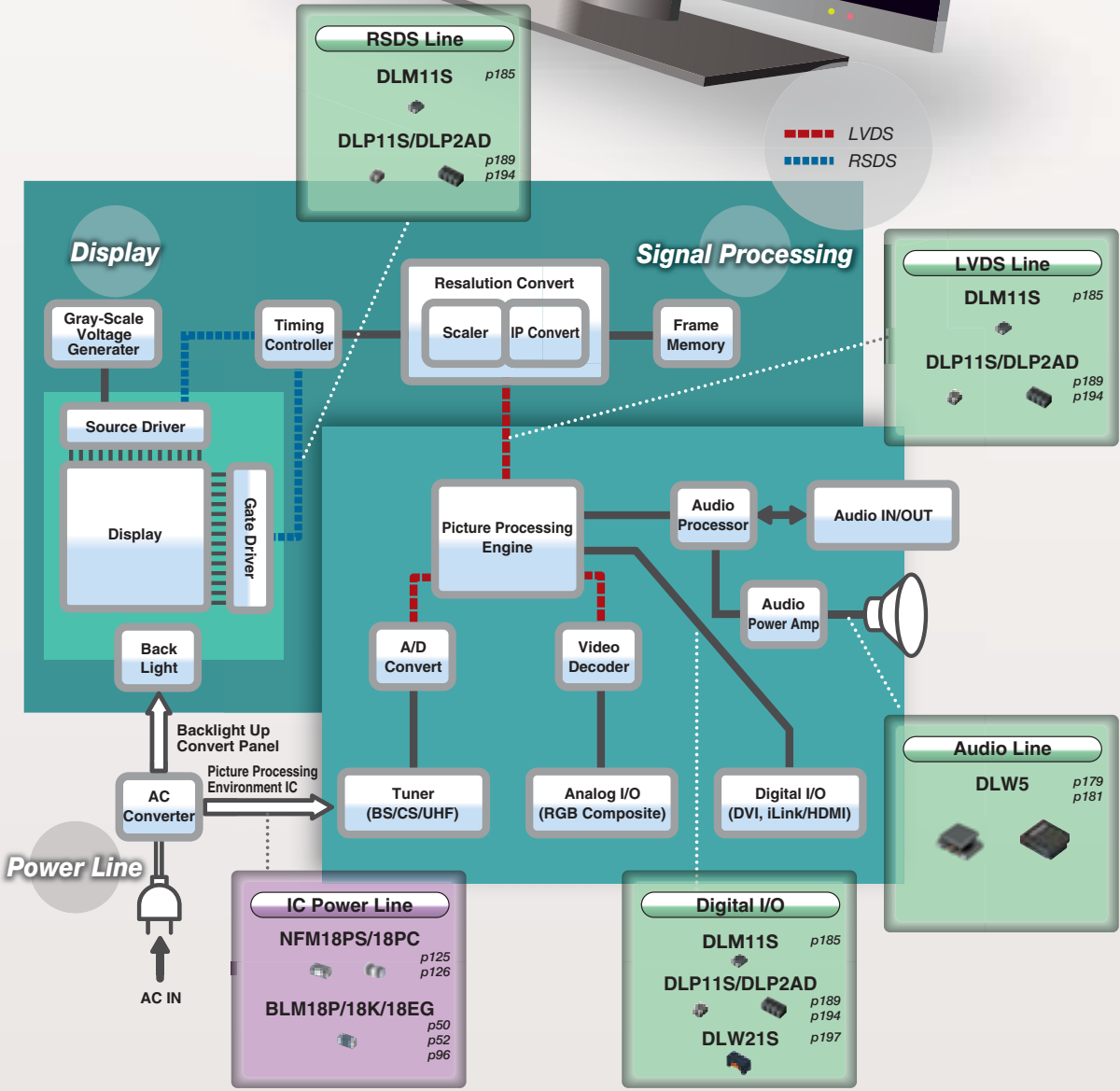

△Note • Please read rating and △CAUTION (for storage, operating, rating, soldering, mounting and handling) in this catalog to prevent smoking and/or burning, etc.  
 • This catalog has only typical specifications. Therefore, please approve our product specifications or transact the approval sheet for product specifications before ordering.

# EMI Filter Selection by Circuits and Noise Frequency





























## ● Chip Ferrite Bead / Chip EMIFIL®

|  |   | Circuit Type?  |  |  |
|--|---|--|--|--|
|  |   | Power Line   | General Signal Line<br>Under 10MHz             | High Speed Signal Line<br>Over 10MHz                 |
| Noise Frequency: Under 1GHz                    | Inductor Type<br>(Suppression Effect: Normal) | BLM02AX<br>01005(0402)/Imp.10-120Ω p24               | BLM03AX<br>0201(0603)/0.2-1A/Imp.10-1000Ω p30  | BLM02BX<br>01005(0402)/Imp.150Ω p26                  |
|  |   | BLM03PG<br>0201(0603)/0.75-0.9A/Imp.22-33Ω p27       | BLM03AG<br>0201(0603)/Imp.10-1000Ω p32         | BLM03B<br>0201(0603)/Imp.10-600Ω p34                 |
|  |   | <b>Low DC Resistance / High Current Type</b>         | BLM15AG<br>0402(1005)/Imp.10-1000Ω p42         | BLM15BX<br>0402(1005)/0.25-0.6A/Imp.75-1800Ω p44     |
|  |   | BLM03PX<br>0201(0603)/1-1.8A/Imp.22-80Ω p28          | BLM18A<br>0603(1608)/Imp.120-1000Ω p56         | BLM15B<br>0402(1005)/Imp.5-1800Ω p46                 |
|  |   | BLM15AX<br>0402(1005)/0.35-1.74A/Imp.10-1000Ω p40    | BLM18A<br>0603(1608)/Imp.120-1000Ω p56         | BLM18B<br>0603(1608)/Imp.5-2500Ω p58                 |
|  |   | BLM15PX<br>0402(1005)/0.9-3A/Imp.33-600Ω p36         | BLM18T<br>0603(1608)/Imp.120-1000Ω p62         | BLM21B<br>0805(2012)/Imp.5-2700Ω p70                 |
|  |   | BLM15PG/PD<br>0402(1005)/1-2.2A/Imp.10-120Ω p38      | BLM18R<br>0603(1608)/Imp.120-1000Ω p63         | <b>Array Type</b>                                    |
|  |   | BLM18P<br>0603(1608)/0.5-3A/Imp.30-470Ω p50          | BLM21A<br>0805(2012)/Imp.120-1000Ω p68         | BLA2AB<br>0804(2010)/Imp.10-1000Ω p80                |
|  |   | BLM21P<br>0805(2012)/1.5-6A/Imp.22-330Ω p66          | BLM21R<br>0805(2012)/Imp.120-1000Ω p73         | BLA31B<br>1206(3216)/Imp.120-1000Ω p83               |
|  |   | BLM31P<br>1206(3216)/1.5-6A/Imp.33-600Ω p75          | <b>Array Type</b>                              |  |
| BLM41P<br>1806(4516)/1.5-6A/Imp.60-1000Ω p77   | BLA2AA<br>0804(2010)/Imp.120-1000Ω p80        |  |  |  |
| BLE32P<br>1210(3225)/10A/Imp.30Ω p79           | BLA31A<br>1206(3216)/Imp.30-1000Ω p83         |  |  |  |
| <b>Low DC Resistance Type</b>                  |   |  |  |  |
| BLM18K<br>0603(1608)/1.3-6A/Imp.26-600Ω p52    |   |  |  |  |
| BLM18S<br>0603(1608)/1.5-6A/Imp.26-330Ω p54    |   |  |  |  |
| Noise Frequency: High                          | Capacitor Type<br>(Suppression Effect: High)  | NFM15PC<br>0402(1005)/Cap.0.047-4.3μF p123           | NFM15CC<br>0402(1005)/Cap.2200-22000pF p134    | <b>LC Combined</b>                                   |
|  |   | NFM18PC<br>0603(1608)/2-4A/Cap.0.1-2.2μF p126        | NFM18CC<br>0603(1608)/Cap.22-22000pF p135      | NFL15ST<br>0402(1005)/Cut off 150-500MHz p140        |
|  |   | NFM21PC<br>0805(2012)/2-6A/Cap.0.1-4.7μF p129        | NFM21CC<br>0805(2012)/Cap.22-22000pF p136      | NFL18ST<br>0603(1608)/Cut off 50-500MHz p141         |
|  |   | NFM3DPC<br>1205(3212)/2A/Cap.0.022μF p130            | NFM3DCC<br>1205(3212)/Cap.22-22000pF p137      | NFL18SP<br>0603(1608)/Cut off 150-500MHz p143        |
|  |   | NFM31PC<br>1206(3216)/6A/Cap.27μF p131               | NFM41CC<br>1806(4516)/Cap.22-22000pF p138      | NFL21SP<br>0805(2012)/Cut off 10-500MHz p144         |
|  |   | NFM31KC<br>1206(3216)/6-10A/Cap.0.01-0.1μF p132      | <b>Array Type</b>                              | NFW31SP<br>1206(3216)/Cut off 10-500MHz p150         |
|  |   | NFM41PC<br>1806(4516)/2-6A/Cap.0.2-1.5μF p133        | NFA31CC<br>1206(3216)/Cap.22-22000pF p139      | <b>RC Combined</b>                                   |
|  |   | <b>T Circuit Filter Feed Through Type</b>            | <b>T Circuit Filter Feed Through Type</b>      | NFR21GD<br>0805(2012)/22-100Ω/Cap.10-100pF p152      |
|  |   | NFE31PT<br>1206(3216)/6A/Cap.22-2200pF p121          | NFE31PT<br>1206(3216)/Cap.22-2200pF p121       | <b>Array Type (RC/LC Combined)</b>                   |
|  |   | NFE61PT<br>2706(6816)/2A/Cap.33-4700pF p122          | NFE61PT<br>2706(6816)/Cap.33-4700pF p122       | NFA31GD<br>1206(3216)/6.8-100Ω/Cap.10-100pF p153     |
| <b>Block Type</b>                              |   | NFA18SL/NFA18SD<br>0603(1608)/Cut off 50-480MHz p145 |  |  |
| BNX022/023<br>10-15A p221                      |   | NFA21SL<br>0805(2012)/Cut off 50-330MHz p148         |  |  |
| Noise Frequency: GHz Band (800MHz to 2.5GHz)   | Inductor Type<br>(Suppression Effect: Normal) |  | BLM03HG<br>0201(0603)/Imp.600-1200Ω p85        | BLM03HD<br>0201(0603)/Imp.330-1000Ω p85              |
|  |   |  | BLM15HG<br>0402(1005)/Imp.600-1000Ω p88        | BLM03HB<br>0201(0603)/Imp.190Ω p85                   |
|  |   |  | BLM18HG<br>0603(1608)/Imp.470-1000Ω p92        | BLM15HD<br>0402(1005)/Imp.600-1800Ω p88              |
|  |   |  | BLM18HK<br>0603(1608)/Imp.330-1000Ω p92        | BLM15HB<br>0402(1005)/Imp.120-220Ω p88               |
|  |   | BLM18HE<br>0603(1608)/0.5-0.8A/Imp.600-1500Ω p92     |  | BLM18HD<br>0603(1608)/Imp.470-1000Ω p92              |
|  |   |  |  | BLM18HE<br>0603(1608)/Imp.600-1500Ω p92              |
|  |   |  | BLM03E<br>0201(0603)/0.4-0.6A/Imp.25-50Ω p87   | BLM18HB<br>0603(1608)/Imp.120-330Ω p92               |
|  |   |  | BLM15E<br>0402(1005)/0.7-1.5A/Imp.120-220Ω p90 |  |
|  |   |  | BLM18E<br>0603(1608)/0.5-2A/Imp.100-600Ω p96   |  |
|  |   |  |  |  |
| Noise Frequency: High-Chz Band (1GHz to 10GHz) | Capacitor Type<br>(Suppression Effect: High)  | NFM18PS<br>0603(1608)/2A/Cap.0.47-1.0μF p125         |  | <b>LC Combined</b>                                   |
|  |   | NFM21PS<br>0805(2012)/4A/Cap.10μF p128               |  | NFL18ST<br>0603(1608)/Cut off 50-500MHz p141         |
| Inductor Type                                  |   |  |  | <b>Array Type (LC Combined)</b>                      |
|  |   |  |  | NFA18SL/NFA18SD<br>0603(1608)/Cut off 50-480MHz p145 |
|  |   | BLM15GG<br>0402(1005)/Imp.220-470Ω p91               |  | NFA21SL<br>0805(2012)/Cut off 50-330MHz p148         |
|  |   | BLM18G<br>0603(1608)/Imp.470Ω p98                    |  |  |
|  |   |  | BLM15GA<br>0402(1005)/Imp.75Ω p91              |  |

△Note • Please read rating and △CAUTION (for storage, operating, rating, soldering, mounting and handling) in this catalog to prevent smoking and/or burning, etc.  
• This catalog has only typical specifications. Therefore, please approve our product specifications or transact the approval sheet for product specifications before ordering.

●Chip Common Mode Choke Coil

Circuit Type?

| DC Power Line   | High Speed Differential Signal Line  |  | Audio Line   |
|---|--|--|--|
|   | High Speed Signal Line<br>(USB/LVDS/IEEE1394/mipi etc.)  | Ultra High Speed Signal Line<br>(HDMI/DVI/Display Port etc.)   |  |
|  <b>DLW5AH</b> <small>p177</small><br>2014(5036)/0.2A/Imp.4000Ω            |  <b>DLM11S</b> <small>p185</small><br>0504(1210)/Imp.45-90Ω       |  <b>DLP0QSA</b> <small>p186</small><br>025020(0605)/Imp.7-35Ω   |  <b>DLM11G</b> <small>p184</small><br>0504(1210)/Imp.600Ω             |
|  <b>DLW5AT</b> <small>p179</small><br>2014(5036)/1-6A/Imp.50-2700Ω         |  <b>DLP0QSN</b> <small>p186</small><br>025020(0605)/Imp.60Ω       |  <b>DLP0NSA</b> <small>p187</small><br>03025(0806)/Imp.7-15Ω    |  <b>DLW5AT</b> <small>p179</small><br>2014(5036)/1-6A/Imp.50-2700Ω    |
|  <b>DLW5BS</b> <small>p177</small><br>2020(5050)/0.5-5A/Imp.190-3000Ω      |  <b>DLP0NSC/SN</b> <small>p187</small><br>03025(0806)/Imp.28-120Ω |  <b>DLP11SA</b> <small>p189</small><br>0504(1210)/Imp.35-90Ω    |  <b>DLW5BT</b> <small>p179</small><br>2020(5050)/1.5-6A/Imp.100-1400Ω |
|  <b>DLW5BT</b> <small>p179</small><br>2020(5050)/1.5-6A/Imp.100-1400Ω      |  <b>DLP11SN</b> <small>p189</small><br>0504(1210)/Imp.67-330Ω     |  <b>DLP11RB</b> <small>p189</small><br>0504(1210)/Imp.15-40Ω    |  |
| <b>High Current Type Automotive Available</b>   |  <b>DLP11RN</b> <small>p189</small><br>0504(1210)/Imp.45Ω         |  <b>DLP11TB</b> <small>p189</small><br>0504(1210)/Imp.80Ω       |  |
|  <b>PLT10HH</b> <small>p202</small><br>12.9mmx6.6mm<br>/6-18A/Imp.45-1000Ω |  <b>DLW21H</b> <small>p199</small><br>0805(2012)/Imp.67-180Ω      | <b>Array Type</b>  |  |
|   |  <b>DLW21S_S/X</b> <small>p197</small><br>0805(2012)/Imp.67-500Ω  |  <b>DLW21S_HQ</b> <small>p197</small><br>0805(2012)/Imp.67-120Ω |  |
|   |  <b>DLP31S</b> <small>p192</small><br>1206(3216)/Imp.120-550Ω     |  <b>DLP2ADA</b> <small>p194</small><br>0804(2010)/Imp.35-90Ω    |  |
|   |  <b>DLW31S</b> <small>p200</small><br>1206(3216)/Imp.90-2200Ω     |  |  |
|   | <b>Automotive Available</b>  |  |  |
|   |  <b>DLW43S</b> <small>p201</small><br>1812(4532)                 |  |  |
|   | <b>Array Type</b>  |  |  |
|   |  <b>DLP1ND</b> <small>p193</small><br>05025(1506)/Imp.35-90Ω    |  |  |
|   |  <b>DLP2ADN</b> <small>p194</small><br>0804(2010)/Imp.67-280Ω   |  |  |
|   |  <b>DLP31D</b> <small>p196</small><br>1206(3216)/Imp.90-440Ω    |  |  |

Guide of Digits in this Chart:

●for BLM03P

0201(0603)/0.75-0.9A/Imp.22-33Ω  
 Size (inch)    Size (mm)    Rated Current    Impedance

●for NFA18S

0603(1608)/Cut off 50-480MHz  
 Size (inch)    Size (mm)    Cut-off Frequency

●for BNX022/023

10-15A/Range1MHz-2GHz  
 Rated Current    Effective Frequency Range

●for DLW5BS

2020(5050)/0.5-5A/Imp.190-3000Ω  
 Size (inch)    Size (mm)    Rated Current    Impedance

●for NFR21GD

0805(2012)/22-100Ω/Cap.10-100pF  
 Size (inch)    Size (mm)    Resistance    Capacitance

△Note • Please read rating and △CAUTION (for storage, operating, rating, soldering, mounting and handling) in this catalog to prevent smoking and/or burning, etc.  
 • This catalog has only typical specifications. Therefore, please approve our product specifications or transact the approval sheet for product specifications before ordering.



| Inductor Type                                      |  | Series   | Size Code in inch (in mm) | Impedance ( $\Omega$ ) at 100MHz |                |               | Effective Frequency Range<br>(Applicable Frequency Ranges are only for reference.) |            |             |                |             |             |            |            |      |  |  |  |  |  |
|--|--|--|---------------------------|----------------------------------|----------------|---------------|--|------------|-------------|----------------|-------------|-------------|------------|------------|------|--|--|--|--|--|
|  |  |  |                           | 10                               | 100            | 1000          | 10kHz  | 100kHz     | 1MHz        | 10MHz          | 100MHz      | 1GHz        | 10GHz      |            |      |  |  |  |  |  |
| For General Band Noise                             | Universal Type<br>[ Power Lines / Signal Lines ] | BLM02AX <sup>p24</sup>                           | 01005 (0402)              | 10                               | 70             | 120           |  |            |             |                |             |             |            |            |      |  |  |  |  |  |
|  |  | BLM03AX <sup>p30</sup>                           | 0201 (0603)               | 10                               | 80             | 120           | 240  | 600        | 1000        |                |             |             |            |            |      |  |  |  |  |  |
|  |  | BLM15AX <sup>p40</sup>                           | 0402 (1005)               | 10                               | 30             | 70            | 120  | 220        | 600         | 1000           |             |             |            |            |      |  |  |  |  |  |
|  | Signal Lines Type                                | For General Signal Lines                         | BLM03AG <sup>p32</sup>    | 0201 (0603)                      | 10             | 80            | 120  | 240        | 600         | 1000           |             |             |            |            |      |  |  |  |  |  |
|  |  |  | BLM15AG <sup>p42</sup>    | 0402 (1005)                      | 10             | 70            | 120  | 220        | 600         | 1000           |             |             |            |            |      |  |  |  |  |  |
|  |  |  | BLM18A <sup>p56</sup>     | 0603 (1608)                      |                |               |  | 220        | 470         | 120            | 150         | 330         | 600        | 1000       |      |  |  |  |  |  |
|  |  |  | BLM21A <sup>p68</sup>     | 0805 (2012)                      |                |               |  | 220        | 470         | 120            | 150         | 330         | 600        | 1000       |      |  |  |  |  |  |
|  |  |  | BLM18T <sup>p62</sup>     | 0603 (1608)                      |                |               |  | 120        | 220         | 600            | 1000        |             |            |            |      |  |  |  |  |  |
|  |  | BLA2AA <sup>p80</sup><br>(4 circuits array)      | 0804 (2010)               |                                  |                |               | 120  | 220        | 600         | 1000           |             |             |            |            |      |  |  |  |  |  |
|  |  | BLA31A <sup>p83</sup><br>(4 circuits array)      | 1206 (3216)               | 30                               | 60             | 120           | 220  | 600        | 1000        |                |             |             |            |            |      |  |  |  |  |  |
|  |  | For High Speed Signal Lines                      | BLM02BX <sup>p26</sup>    | 01005 (0402)                     |                |               |  | 150        |             |                |             |             |            |            |      |  |  |  |  |  |
|  |  |  | BLM03B <sup>p34</sup>     | 0201 (0603)                      | 10             | 22            | 33   | 56         | 80          | 600            |             |             |            |            |      |  |  |  |  |  |
|  |  |  | BLM15B <sup>p44</sup>     | 0402 (1005)                      | 5              | 10            | 22   | 33         | 47          | 75             | 120         | 220         | 470        | 1000       |      |  |  |  |  |  |
|  | BLM18B <sup>p58</sup>                            |  | 0603 (1608)               | 5                                | 10             | 22            | 47   | 60         | 75          | 140            | 220         | 420         | 600        | 1500       | 2200 |  |  |  |  |  |
|  | BLM21B <sup>p70</sup>                            |  | 0805 (2012)               | 5                                |                |               | 75   | 200        | 330         | 470            | 750         | 1500        | 2200       | 2700       |      |  |  |  |  |  |
|  | For Digital Interface Lines                      | BLA2AB <sup>p80</sup><br>(4 circuits array)      | 0804 (2010)               | 10                               | 22             | 47            | 75   | 120        | 220         | 470            | 1000        |             |            |            |      |  |  |  |  |  |
|  |  | BLA31B <sup>p83</sup><br>(4 circuits array)      | 1206 (3216)               |                                  |                |               |  |            | 600         | 470            | 1000        |             |            |            |      |  |  |  |  |  |
|  |  | BLM18R <sup>p63</sup>                            | 0603 (1608)               |                                  |                |               |  |            | 600         | 120            | 220         | 470         | 1000       |            |      |  |  |  |  |  |
|  | BLM21R <sup>p73</sup>                            | 0805 (2012)                                      |                           |                                  |                |               |  | 600        | 120         | 220            | 470         | 1000        |            |            |      |  |  |  |  |  |
|  | Power Lines Type                                 | BLM03PX* <sup>p28</sup>                          | 0201 (0603)               |                                  |                |               | 33 (1.5A)  | 80 (1A)    | 22 (1.8A)   |                |             |             |            |            |      |  |  |  |  |  |
| BLM03PG <sup>p27</sup>                             |  | 0201 (0603)                                      |                           |                                  |                | 33 (0.75A)    | 22 (0.9A)  |            |             |                |             |             |            |            |      |  |  |  |  |  |
| BLM15P* <sup>p36</sup>                             |  | 0402 (1005)                                      | 10 (1A)                   | 30 (2.2A)                        | 60 (1.7A/2.5A) | 120 (1.3A/2A) | 330 (1.2A)   | 600 (0.9A) | 33 (3A)     | 80 (1.5A/2.3A) | 180 (1.5A)  | 220 (1.4A)  | 470 (1A)   |            |      |  |  |  |  |  |
| BLM18P* <sup>p50</sup>                             |  | 0603 (1608)                                      | 30 (1A)                   | 60 (0.5A)                        | 180 (1.5A)     | 330 (1.2A)    | 33 (3A)  | 120 (2A)   | 220 (1.4A)  | 470 (1A)       |             |             |            |            |      |  |  |  |  |  |
| BLM21P* <sup>p66</sup>                             |  | 0805 (2012)                                      | 22 (6A)                   | 60 (3.5A)                        | 120 (3A)       | 330 (1.5A)    | 30 (4A)  | 220 (2A)   |             |                |             |             |            |            |      |  |  |  |  |  |
| BLM31P* <sup>p75</sup>                             |  | 1206 (3216)                                      | 33 (6A)                   | 50 (3.5A)                        | 120 (3.5A)     | 390 (2A)      | 600 (1.5A)   |            |             |                |             |             |            |            |      |  |  |  |  |  |
| BLM41P* <sup>p77</sup>                             |  | 1806 (4516)                                      | 60 (6A)                   | 75 (3.5A)                        | 180 (3.5A)     | 470 (2A)      | 1000 (1.5A)  |            |             |                |             |             |            |            |      |  |  |  |  |  |
| BLM18K* <sup>p52</sup><br>(Low DC Resistance Type) |  | 0603 (1608)                                      | 26 (6A)                   | 30 (5A)                          | 70 (3.5A)      | 220 (2.2A)    | 470 (1.5A)   |            |             |                |             |             |            |            |      |  |  |  |  |  |
| BLM18S* <sup>p54</sup><br>(Low DC Resistance Type) |  | 0603 (1608)                                      | 26 (6A)                   | 70 (4A)                          | 220 (2.5A)     | 120 (3A)      | 330 (1.5A)   |            |             |                |             |             |            |            |      |  |  |  |  |  |
| BLE32P <sup>p79</sup>                              |  | 1210 (3225)                                      | 30                        |                                  |                |               |  |            |             |                |             |             |            |            |      |  |  |  |  |  |
| For GHz Band Noise                                 |  | Universal Type<br>[ Power Lines / Signal Lines ] | BLM03E* <sup>p87</sup>    | 0201 (0603)                      | 25 (0.6A)      | 50 (0.4A)     |  |            |             |                |             |             |            |            |      |  |  |  |  |  |
|  |  |  | BLM15E* <sup>p90</sup>    | 0402 (1005)                      |                |               |  | 220 (0.7A) |             |                |             |             |            |            |      |  |  |  |  |  |
|  |  |  | BLM18EG* <sup>p96</sup>   | 0603 (1608)                      |                |               |  | 120 (2A)   | 330 (0.5A)  | 470 (0.5A)     | 100 (2A)    | 220 (2A/1A) | 390 (0.5A) | 600 (0.5A) |      |  |  |  |  |  |
|  | BLM18HE* <sup>p92</sup>                          |  | 0603 (1608)               |                                  |                |               |  |            | 1000 (0.6A) | 600 (0.8A)     | 1500 (0.5A) |             |            |            |      |  |  |  |  |  |
|  | Signal Lines Type                                | BLM03HG <sup>p85</sup>                           | 0201 (0603)               |                                  |                |               |  |            | 1000        | 600            | 1200        |             |            |            |      |  |  |  |  |  |
|  |  | BLM03HD <sup>p85</sup>                           | 0201 (0603)               |                                  |                |               |  |            | 600         | 330            | 470         | 1000        |            |            |      |  |  |  |  |  |
|  |  | BLM03HB <sup>p85</sup>                           | 0201 (0603)               |                                  |                |               | 190  |            |             |                |             |             |            |            |      |  |  |  |  |  |
|  |  | BLM15HG <sup>p88</sup>                           | 0402 (1005)               |                                  |                |               |  |            | 600         | 1000           |             |             |            |            |      |  |  |  |  |  |
|  |  | BLM15HD <sup>p88</sup>                           | 0402 (1005)               |                                  |                |               |  |            | 600         | 1000           | 1800        |             |            |            |      |  |  |  |  |  |
|  |  | BLM15HB <sup>p88</sup>                           | 0402 (1005)               |                                  |                |               | 120  | 220        |             |                |             |             |            |            |      |  |  |  |  |  |
|  |  | BLM18HG <sup>p92</sup>                           | 0603 (1608)               |                                  |                |               |  |            | 600         | 470            | 1000        |             |            |            |      |  |  |  |  |  |
|  |  | BLM18HD <sup>p92</sup>                           | 0603 (1608)               |                                  |                |               |  |            | 600         | 470            | 1000        |             |            |            |      |  |  |  |  |  |
|  |  | BLM18HB <sup>p92</sup>                           | 0603 (1608)               |                                  |                |               | 120  | 220        | 330         |                |             |             |            |            |      |  |  |  |  |  |
|  |  | BLM18HK <sup>p92</sup>                           | 0603 (1608)               |                                  |                |               |  |            | 600         | 330            | 470         | 1000        |            |            |      |  |  |  |  |  |
|  |  | For High-GHz Band Noise                          | Signal Lines Type         | BLM15GG <sup>p91</sup>           | 0402 (1005)    |               |  |            |             | 220            | 470         |             |            |            |      |  |  |  |  |  |
|  |  |  |                           | BLM15GA <sup>p91</sup>           | 0402 (1005)    |               |  |            | 75          |                |             |             |            |            |      |  |  |  |  |  |
| BLM18G <sup>p98</sup>                              | 0603 (1608)                                      |  |                           |                                  |                |               |  |            | 470         |                |             |             |            |            |      |  |  |  |  |  |

\* The derating of rated current is required for some items according to the operating temperature on each product page.

△Note • Please read rating and △CAUTION (for storage, operating, rating, soldering, mounting and handling) in this catalog to prevent smoking and/or burning, etc.  
• This catalog has only typical specifications. Therefore, please approve our product specifications or transact the approval sheet for product specifications before ordering.



| Capacitor Type                                 | Series                                     | Size Code<br>in inch (in mm) | Capacitance (F) |      |       |        |       |       |       | Effective Frequency Range<br>(Applicable Frequency Ranges are only for reference.) |        |      |       |        |      |       |
|--|--|------------------------------|-----------------|------|-------|--------|-------|-------|-------|--|--------|------|-------|--------|------|-------|
|  |  |                              | 10p             | 100p | 1000p | 10000p | 0.1μ  | 1μ    | 10μ   | 10kHz  | 100kHz | 1MHz | 10MHz | 100MHz | 1GHz | 10GHz |
| Signal Lines Type                              | NFM15CC <sup>p134</sup>                    | 0402 (1005)                  |                 |      | 2200  | 22000  |       |       |       |  |        |      |       |        |      |       |
|  | NFM18CC <sup>p135</sup>                    | 0603 (1608)                  |                 | 22   | 47    | 100    | 220   | 470   | 2200  | 1000   | 22000  |      |       |        |      |       |
|  | NFM21CC <sup>p136</sup>                    | 0805 (2012)                  |                 | 22   | 47    | 100    | 220   | 470   | 2200  | 1000   | 22000  |      |       |        |      |       |
|  | NFM3DCC <sup>p137</sup>                    | 1205 (3212)                  |                 | 22   | 47    | 100    | 220   | 470   | 2200  | 1000   | 22000  |      |       |        |      |       |
|  | NFM41CC <sup>p138</sup>                    | 1806 (4516)                  |                 | 22   | 47    | 100    | 220   | 470   | 2200  | 1000   | 22000  |      |       |        |      |       |
|  | NFA31CC (4 circuits array) <sup>p139</sup> | 1206 (3216)                  |                 | 22   | 47    | 100    | 220   | 470   | 2200  | 1000   | 22000  |      |       |        |      |       |
| Power Lines Type                               | NFM15PC <sup>p123</sup>                    | 0402 (1005)                  |                 |      |       |        |       | 47000 | 0.22  | 1.0  |        |      |       |        |      |       |
|  | NFM18PS <sup>p125</sup>                    | 0603 (1608)                  |                 |      |       |        |       | 0.1   | 0.47  | 4.3  |        |      |       |        |      |       |
|  | NFM18PC <sup>p126</sup>                    | 0603 (1608)                  |                 |      |       |        |       |       | 1.0   | 0.47   |        |      |       |        |      |       |
|  | NFM21PS <sup>p128</sup>                    | 0805 (2012)                  |                 |      |       |        |       |       | 0.22  | 1.0  | 2.2    |      |       |        |      |       |
|  | NFM21PC <sup>p129</sup>                    | 0805 (2012)                  |                 |      |       |        |       | 0.1   | 0.47  | 2.2  | 4.7    |      |       |        |      |       |
|  | NFM3DPC* <sup>p130</sup>                   | 1205 (3212)                  |                 |      |       |        | 22000 |       |       |  |        |      |       |        |      |       |
|  | NFM31PC <sup>p131</sup>                    | 1206 (3216)                  |                 |      |       |        |       |       |       |  |        | 27   |       |        |      |       |
|  | NFM31KC* <sup>p132</sup>                   | 1206 (3216)                  |                 |      |       |        | 10000 | 22000 | 15000 | 0.1  |        |      |       |        |      |       |
|  | NFM41PC <sup>p133</sup>                    | 1806 (4516)                  |                 |      |       |        |       |       | 0.2   | 1.5  |        |      |       |        |      |       |
| Universal Type<br>[Power Lines / Signal Lines] | NFE31PT <sup>p121</sup>                    | 1206 (3216)                  |                 | 22   | 47    | 100    | 220   | 470   | 2200  | 1500   |        |      |       |        |      |       |
|  | NFE61PT <sup>p122</sup>                    | 2706 (6816)                  |                 | 33   | 68    | 180    | 680   | 4700  |       |  |        |      |       |        |      |       |



| LC(RC) Combined Type | Series                                     | Size Code<br>in inch (in mm) | Cut-off Frequency (MHz) |    |    |     |     |     |     | Effective Frequency Range<br>(Applicable Frequency Ranges are only for reference.) |     |     |       |        |      |       |        |      |
|----------------------|--|------------------------------|-------------------------|----|----|-----|-----|-----|-----|--|-----|-----|-------|--------|------|-------|--------|------|
|                      |  |                              | 10                      | 20 | 50 | 70  | 100 | 150 | 200 | 300  | 400 | 500 | 10kHz | 100kHz | 1MHz | 10MHz | 100MHz | 1GHz |
| Signal Lines Type    | NFL15ST <sup>p140</sup>                    | 0402 (1005)                  |                         |    |    |     |     | 150 | 200 | 300  | 500 |     |       |        |      |       |        |      |
|                      | NFL18ST <sup>p141</sup>                    | 0603 (1608)                  |                         |    | 50 | 70  | 100 |     | 200 | 300  | 500 |     |       |        |      |       |        |      |
|                      | NFL18SP <sup>p143</sup>                    | 0603 (1608)                  |                         |    |    |     |     | 150 | 200 | 300  | 500 |     |       |        |      |       |        |      |
|                      | NFL21SP <sup>p144</sup>                    | 0805 (2012)                  | 10                      | 20 | 50 | 70  | 100 | 150 | 200 | 300  | 400 | 500 |       |        |      |       |        |      |
|                      | NFA18SL (4 circuits array) <sup>p145</sup> | 0603 (1608)                  |                         |    | 50 |     | 130 | 180 | 220 | 300  | 350 | 480 |       |        |      |       |        |      |
|                      | NFA18SD (4 circuits array) <sup>p147</sup> | 0603 (1608)                  |                         |    |    |     |     |     | 200 |  |     |     |       |        |      |       |        |      |
|                      | NFA21SL (4 circuits array) <sup>p148</sup> | 0805 (2012)                  |                         |    | 50 | 80  |     |     | 200 | 280  | 310 | 300 | 330   |        |      |       |        |      |
|                      | NFW31SP <sup>p150</sup>                    | 1206 (3216)                  | 10                      | 20 | 50 | 100 | 150 | 200 | 300 | 400  | 500 |     |       |        |      |       |        |      |
|                      | NFR21GD <sup>p152</sup>                    | 0805 (2012)                  |                         |    |    |     |     |     |     |  |     |     |       |        |      |       |        |      |
|                      | NFA31GD (4 circuits array) <sup>p153</sup> | 1206 (3216)                  |                         |    |    |     |     |     |     |  |     |     |       |        |      |       |        |      |

\* The derating of rated current is required for some items according to the operating temperature on each product page.

⚠Note • Please read rating and ⚠CAUTION (for storage, operating, rating, soldering, mounting and handling) in this catalog to prevent smoking and/or burning, etc.  
• This catalog has only typical specifications. Therefore, please approve our product specifications or transact the approval sheet for product specifications before ordering.

# DL

## Common Mode Choke Coils

| Signal Lines Type                             | Series                                     | Size Code in inch (in mm) | Common Mode Impedance (Ω) at 100MHz |            |            | Effective Frequency Range<br>(Applicable Frequency Ranges are only for reference.) |            |       |        |      |       |
|---|--|---------------------------|-------------------------------------|------------|------------|--|------------|-------|--------|------|-------|
|   |  |                           | 100                                 | 500        | 1000       | 100kHz   | 1MHz       | 10MHz | 100MHz | 1GHz | 10GHz |
|   |  |                           |                                     |            |            | 100kHz   | 1MHz       | 10MHz | 100MHz | 1GHz | 10GHz |
| For Audio Lines                               | DLM11G <sup>p184</sup>                     | 0504 (1210)               | 600                                 |            |            |  |            |       |        |      |       |
|   | DLM11S <sup>p185</sup>                     | 0504 (1210)               | 45                                  | 90         |            |  |            |       |        |      |       |
| For Ultra High Speed Signal Lines             | DLP0QSN <sup>p186</sup>                    | 025020 (0605)             | 60                                  |            |            |  |            |       |        |      |       |
|   | DLP0QSA <sup>p186</sup>                    | 025020 (0605)             | 15<br>7                             | 35         |            |  |            |       |        |      |       |
|   | DLP0NSC <sup>p187</sup>                    | 03025 (0806)              | 28                                  |            |            |  |            |       |        |      |       |
|   | DLP0NSN <sup>p187</sup>                    | 03025 (0806)              | 35<br>67                            | 90<br>120  |            |  |            |       |        |      |       |
|   | DLP0NSA <sup>p187</sup>                    | 03025 (0806)              | 15<br>7                             |            |            |  |            |       |        |      |       |
|   | DLP11SN <sup>p189</sup>                    | 0504 (1210)               | 67<br>90                            | 120<br>160 | 240<br>200 | 280<br>330   |            |       |        |      |       |
|   | DLP11SA <sup>p189</sup>                    | 0504 (1210)               | 35<br>67                            | 90         |            |  |            |       |        |      |       |
|   | DLP11RN <sup>p190</sup>                    | 0504 (1210)               | 45                                  |            |            |  |            |       |        |      |       |
|   | DLP11RB <sup>p190</sup>                    | 0504 (1210)               | 15                                  | 40         |            |  |            |       |        |      |       |
|   | DLP11TB <sup>p191</sup>                    | 0504 (1210)               | 80                                  |            |            |  |            |       |        |      |       |
|   | DLP31S <sup>p192</sup>                     | 1206 (3216)               | 120                                 | 220        | 550        |  |            |       |        |      |       |
|   | DLP1NDN (2 circuits array) <sup>p193</sup> | 05025 (1506)              | 35<br>67                            | 90         |            |  |            |       |        |      |       |
|   | DLP2ADA (2 circuits array) <sup>p194</sup> | 0804 (2010)               | 35<br>67                            | 90         |            |  |            |       |        |      |       |
|   | DLP2ADN (2 circuits array) <sup>p194</sup> | 0804 (2010)               | 90<br>67                            | 120<br>160 | 240<br>200 | 280  |            |       |        |      |       |
|   | DLP31DN (2 circuits array) <sup>p196</sup> | 1206 (3216)               | 90                                  | 130        | 200        | 320  | 440        |       |        |      |       |
|   | DLW21S <sup>p197</sup>                     | 0805 (2012)               | 90<br>67                            | 120<br>180 | 260        | 370  | 490<br>500 |       |        |      |       |
|   | DLW21H <sup>p199</sup>                     | 0805 (2012)               | 90<br>67                            | 120<br>180 |            |  |            |       |        |      |       |
|   | DLW31SN <sup>p200</sup>                    | 1206 (3216)               | 90                                  | 160        | 260        | 600  | 1000       | 2200  |        |      |       |
|   | DLW43SH <sup>p201</sup>                    | 1812 (4532)               |                                     |            |            |  |            |       |        |      |       |
| Universal Type [ Power Lines / Signal Lines ] | DLW5AH/DLW5BS* <sup>p177</sup>             | 2014 (5036) / 2020 (5050) | 190                                 | 350        | 500        | 600  | 800        | 1000  | 1500   | 4000 | 3000  |
|   | DLW5AT*/DLW5BT* <sup>p179</sup>            | 2014 (5036) / 2020 (5050) | 50<br>100                           | 110<br>150 | 230<br>250 | 330<br>400   | 500        | 1000  | 1400   | 2700 |       |

# PL

## Large Current Common Mode Choke Coil for Automotive Available

| Large Current Type for Automotive Available | Series                   | Size Code in inch (in mm) | Common Mode Impedance (Ω) at 10MHz |            |             | Effective Frequency Range<br>(Applicable Frequency Ranges are only for reference.) |      |       |        |      |       |
|---|--------------------------|---------------------------|------------------------------------|------------|-------------|--|------|-------|--------|------|-------|
|   |                          |                           | 100                                | 500        | 1000        | 100kHz   | 1MHz | 10MHz | 100MHz | 1GHz | 10GHz |
|   |                          |                           |                                    |            |             | 100kHz   | 1MHz | 10MHz | 100MHz | 1GHz | 10GHz |
|   | PLT10HH* <sup>p202</sup> | -                         | 45<br>100                          | 400<br>500 | 900<br>1000 |  |      |       |        |      |       |

# BNX

## Block EMIFIL®

| Power Lines Type        | Series                  | Height (mm) | Rated Voltage (Vdc) | Rated Current (A) | Effective Frequency Range<br>(Applicable Frequency Ranges are only for reference.) |        |      |       |        |      |       |        |
|-------------------------|-------------------------|-------------|---------------------|-------------------|--|--------|------|-------|--------|------|-------|--------|
|                         |                         |             |                     |                   | 10kHz  | 100kHz | 1MHz | 10MHz | 100MHz | 1GHz | 10GHz |        |
|                         |                         |             |                     |                   |  |        |      |       |        |      | 10kHz | 100kHz |
| SMD Type                | BNX022* <sup>p221</sup> | 3.1         | 50                  | 10                |  |        |      |       |        |      |       |        |
|                         | BNX023* <sup>p221</sup> | 3.1         | 100                 | 15                |  |        |      |       |        |      |       |        |
|                         | BNX024* <sup>p221</sup> | 3.5         | 50                  | 15                |  |        |      |       |        |      |       |        |
|                         | BNX025* <sup>p221</sup> | 3.5         | 25                  | 15                |  |        |      |       |        |      |       |        |
|                         | BNX002 <sup>p223</sup>  | 13 max.     | 50                  | 10                |  |        |      |       |        |      |       |        |
|                         | BNX003 <sup>p223</sup>  | 13 max.     | 150                 | 10                |  |        |      |       |        |      |       |        |
|                         | BNX005 <sup>p223</sup>  | 13.5 max.   | 50                  | 15                |  |        |      |       |        |      |       |        |
|                         | BNX012* <sup>p224</sup> | 8.5 max.    | 50                  | 15                |  |        |      |       |        |      |       |        |
| BNX016* <sup>p224</sup> | 8.5 max.                | 25          | 15                  |                   |  |        |      |       |        |      |       |        |

\* The derating of rated current is required for some items according to the operating temperature on each product page.

△Note • Please read rating and △CAUTION (for storage, operating, rating, soldering, mounting and handling) in this catalog to prevent smoking and/or burning, etc.  
• This catalog has only typical specifications. Therefore, please approve our product specifications or transact the approval sheet for product specifications before ordering.

# BL□

## Chip Ferrite Bead

|                              |     |
|------------------------------|-----|
| Series Introduction .....    | 14  |
| Part Numbering .....         | 16  |
| Series Line Up .....         | 18  |
| Product Detail .....         | 24  |
| ⚠Caution/Notice .....        | 99  |
| Soldering and Mounting ..... | 100 |
| Packaging .....              | 104 |
| Design Kits .....            | 105 |

Chip Ferrite Bead

Chip EMIFIL®

Chip Common Mode Choke Coil

Block Type EMIFIL®

Microwave Absorber

⚠Note • Please read rating and ⚠CAUTION (for storage, operating, rating, soldering, mounting and handling) in this catalog to prevent smoking and/or burning, etc.  
• This catalog has only typical specifications. Therefore, please approve our product specifications or transact the approval sheet for product specifications before ordering.

# BL   Series Introduction

## ● Example of Chip Ferrite Bead BLM Series Structure

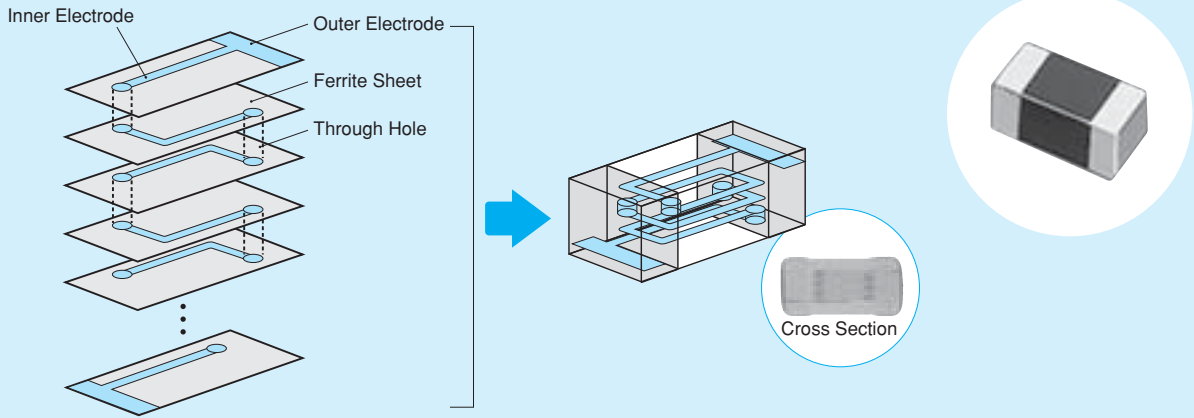

## ● Line Up Classification of Chip Ferrite Bead

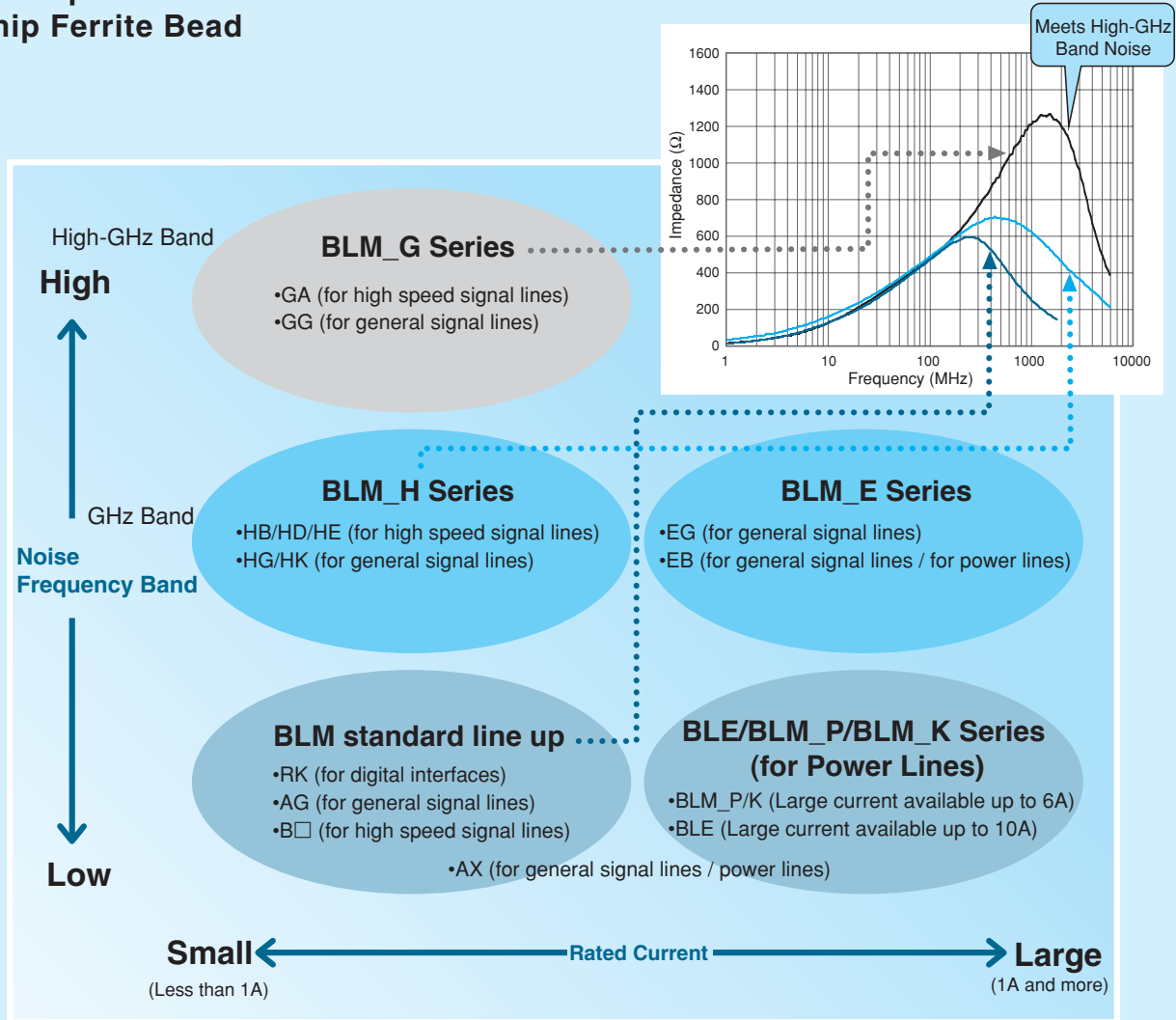

△Note • Please read rating and △CAUTION (for storage, operating, rating, soldering, mounting and handling) in this catalog to prevent smoking and/or burning, etc.  
• This catalog has only typical specifications. Therefore, please approve our product specifications or transact the approval sheet for product specifications before ordering.

Chip Ferrite Bead  
Chip EMIFIL®  
Chip Common Mode Choke Coil  
Block Type EMIFIL®  
Microwave Absorber



### ●Difference between BLM A type and B type (HG type vs HD/HB/HE type)

A type: Impedance curve rises from low frequency range. Suppresses noise in a wide frequency range.  
 B type: Impedance curve rises sharply. Less damage to signal waveforms.

#### ■Comparison of Impedance Curve

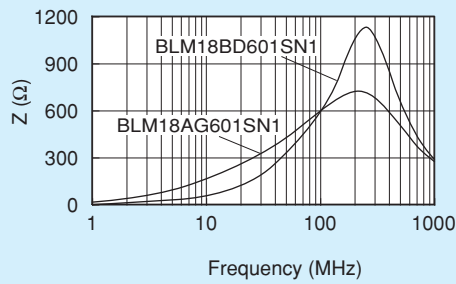

#### ■Comparison of Resistance Element

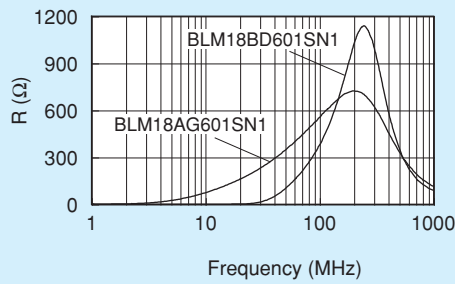

#### ■Comparison of Test Effect (25MHz)

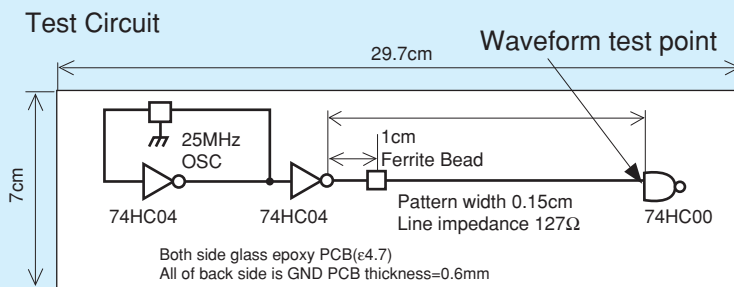

BLM\_B Series has less damage to high speed signal waveform.

Waveform

No filter

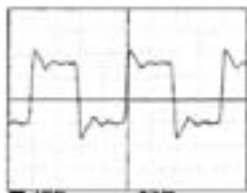

BLM18AG601SN1

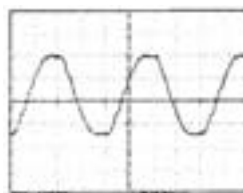

BLM18BD601SN1

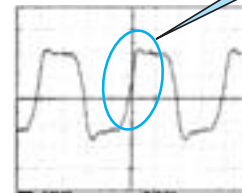

Spectrum

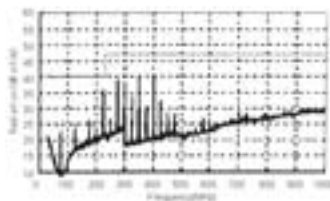
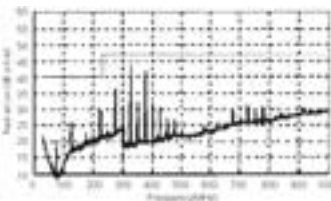
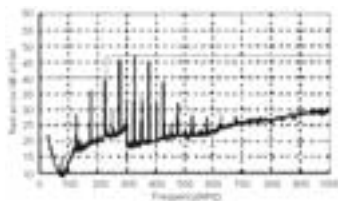

Spectrum has been reduced from low frequency range.

Noise frequency has been reduced without reducing signals of low frequency.

△Note • Please read rating and △CAUTION (for storage, operating, rating, soldering, mounting and handling) in this catalog to prevent smoking and/or burning, etc.  
 • This catalog has only typical specifications. Therefore, please approve our product specifications or transact the approval sheet for product specifications before ordering.

# BL   Chip Ferrite Bead Part Numbering

(Part Number) **BL M 18 AG 102 S N 1 D**  
 ① ② ③ ④ ⑤ ⑥ ⑦ ⑧ ⑨

## ① Product ID

| Product ID |                    |
|------------|--------------------|
| BL         | Chip Ferrite Beads |

## ② Type

| Code | Type                                  |
|------|---------------------------------------|
| A    | Array Type                            |
| E    | DC Bias Characteristics Improved Type |
| M    | Ferrite Bead Single Type              |

## ③ Dimensions (L×W)

| Code | Dimensions (L×W) | EIA   |
|------|------------------|-------|
| 02   | 0.4×0.2mm        | 01005 |
| 03   | 0.6×0.3mm        | 0201  |
| 15   | 1.0×0.5mm        | 0402  |
| 18   | 1.6×0.8mm        | 0603  |
| 2A   | 2.0×1.0mm        | 0804  |
| 21   | 2.0×1.25mm       | 0805  |
| 31   | 3.2×1.6mm        | 1206  |
| 32   | 3.2×2.5mm        | 1210  |
| 41   | 4.5×1.6mm        | 1806  |

## ④ Characteristics/Applications

| Code *1 | Characteristics/Applications                                   | Series                   |
|---------|--|--------------------------|
| AG      | For General Use  | BLM03/15/18/21, BLA2A/31 |
| AX      |  | BLM02/03/15              |
| TG      |  | BLM18                    |
| BA      | For High-speed Signal Lines                                    | BLM15/18                 |
| BB      |  | BLM03/15/18/21, BLA2A    |
| BC      |  | BLM03/15                 |
| BD      |  | BLM03/15/18/21, BLA2A/31 |
| BX      |  | BLM02/15                 |
| PD      |  | BLM15                    |
| PG      |  | BLM03/15/18/21/31/41     |
| PN      | For Power Lines  | BLE32                    |
| PX      |  | BLM03/15                 |
| KG      |  | BLM18                    |
| SG      | For Power Lines (Low DC Resistance Type)                       | BLM18                    |
| RK      | For Digital Interface  | BLM18/21                 |
| HG      | For GHz Band General Use                                       | BLM03/15/18              |
| EB      | For GHz Band High-speed Signal Lines (Low Direct Current Type) | BLM03                    |
| EG      | For GHz Band General Use (Low DC Resistance Type)              | BLM15/18                 |
| HB      | For GHz Band High-speed Signal Lines                           | BLM03/15/18              |
| HD      |  | BLM03/15/18              |
| HE      |  | BLM18                    |
| HK      | For GHz Band Digital Interface                                 | BLM18                    |
| GA      | For High-GHz Band High-speed Signal Lines                      | BLM15                    |
| GG      | For High-GHz Band General Use                                  | BLM15/18                 |

\*1 Frequency characteristics vary with each code.

## ⑤ Impedance

Expressed by three figures. The unit is in ohm ( $\Omega$ ) at 100MHz. The first and second figures are significant digits, and the third figure expresses the number of zeros that follow the two figures.

## ⑥ Electrode

Expressed by a letter.

| Ex.) | Code | Electrode  |
|------|------|------------|
|      | S/T  | Sn Plating |
|      | A    | Au Plating |

## ⑦ Category

| Code | Category      |
|------|---------------|
| N    | Standard Type |

## ⑧ Number of Circuits

| Code | Number of Circuits |
|------|--------------------|
| 1    | 1 Circuit          |
| 4    | 4 Circuits         |

Continued on the following page.

△Note • Please read rating and △CAUTION (for storage, operating, rating, soldering, mounting and handling) in this catalog to prevent smoking and/or burning, etc.  
 • This catalog has only typical specifications. Therefore, please approve our product specifications or transact the approval sheet for product specifications before ordering.

## ⑨ Packaging

| Code     | Packaging                     | Series  |
|----------|-------------------------------|---|
| <b>K</b> | Embossed Taping (ø330mm Reel) | <b>BLE, BLM21<sup>*1</sup>/31/41</b>                      |
| <b>L</b> | Embossed Taping (ø180mm Reel) |   |
| <b>B</b> | Bulk                          | All Series  |
| <b>J</b> | Paper Taping (ø330mm Reel)    | <b>BLM03/15/18<sup>*3</sup>/21<sup>*2</sup>, BLA2A/31</b> |
| <b>D</b> | Paper Taping (ø180mm Reel)    | <b>BLM02/03/15/18/21<sup>*2</sup>, BLA2A/31</b>           |

\*1 BLM21BD222SN1/BLM21BD272SN1 only.

\*2 Except for BLM21BD222SN1/BLM21BD272SN1

\*3 Except for BLM18T

# BL   Chip Ferrite Bead Series Line Up

| Size Code<br>(in inch<br>(in mm)) | Thickness<br>(mm)                            | Type   | Part Number                                  | Impedance         |              | Rated<br>Current | New    | Kit | ≥1A<br>≥3A<br>≥10A | GHz<br>Hi-GHz | Flow    | RefFlow |         |
|-----------------------------------|--|--|--|-------------------|--------------|------------------|--------|-----|--------------------|---------------|---------|---------|---------|
|                                   |  |  |  | at 100MHz/20°C    | at 1GHz/20°C |                  |        |     |                    |               |         |         |         |
| 01005<br>(0402)                   | 0.2  | Universal Type<br>[Power lines/Signal lines]           | p24 BLM02AX100SN1                            | 10ohm±5ohm        | -            | 750mA            |        | Kit |                    |               |         | RefFlow |         |
|                                   | 0.2  |  | BLM02AX700SN1                                | 70ohm±25%         | -            | 300mA            |        | Kit |                    |               |         | RefFlow |         |
|                                   | 0.2  |  | BLM02AX121SN1                                | 120ohm±25%        | -            | 250mA            |        | Kit |                    |               |         | RefFlow |         |
|                                   | 0.2  | For High Speed Signal Lines                            | p26 BLM02BX151SN1                            | 150ohm±25%        | -            | 200mA            | New    |     |                    |               |         | RefFlow |         |
|                                   | 0.3  | For General Signal Lines                               | p32 BLM03AG100SN1                            | 10ohm(Typ.)       | -            | 500mA            |        | Kit |                    |               |         | RefFlow |         |
|                                   | 0.3  |  | BLM03AG700SN1                                | 70ohm(Typ.)       | -            | 200mA            |        | Kit |                    |               |         | RefFlow |         |
|                                   | 0.3  |  | BLM03AG800SN1                                | 80ohm±25%         | -            | 200mA            |        | Kit |                    |               |         | RefFlow |         |
|                                   | 0.3  |  | BLM03AG121SN1                                | 120ohm±25%        | -            | 200mA            |        | Kit |                    |               |         | RefFlow |         |
|                                   | 0.3  |  | BLM03AG241SN1                                | 240ohm±25%        | -            | 200mA            |        | Kit |                    |               |         | RefFlow |         |
| 0.3                               | BLM03AG601SN1                                |  | 600ohm±25%                                   | -                 | 100mA        |                  | Kit    |     |                    |               | RefFlow |         |         |
| 0.3                               | BLM03AG102SN1                                |  | 1000ohm±25%                                  | -                 | 100mA        |                  | Kit    |     |                    |               | RefFlow |         |         |
| 0.3                               | Universal Type<br>[Power lines/Signal lines] | p30 BLM03AX100SN1                                      | 10ohm(Typ.)                                  | -                 | 1000mA       |                  | Kit    | ≥1A |                    |               | RefFlow |         |         |
| 0.3                               |  | BLM03AX800SN1  | 80ohm±25%                                    | -                 | 500mA        |                  | Kit    |     |                    |               | RefFlow |         |         |
| 0.3                               |  | BLM03AX121SN1  | 120ohm±25%                                   | -                 | 450mA        |                  | Kit    |     |                    |               | RefFlow |         |         |
| 0.3                               |  | BLM03AX241SN1  | 240ohm±25%                                   | -                 | 350mA        |                  | Kit    |     |                    |               | RefFlow |         |         |
| 0.3                               |  | BLM03AX601SN1  | 600ohm±25%                                   | -                 | 250mA        |                  | Kit    |     |                    |               | RefFlow |         |         |
| 0.3                               |  | BLM03AX102SN1  | 1000ohm±25%                                  | -                 | 200mA        |                  | Kit    |     |                    |               | RefFlow |         |         |
| 0201<br>(0603)                    | 0.3  | For High Speed Signal Lines<br>(Sharp Impedance Curve) | p34 BLM03BD750SN1                            | 75ohm±25%         | -            | 300mA            |        | Kit |                    |               |         | RefFlow |         |
|                                   | 0.3  |  | BLM03BD121SN1                                | 120ohm±25%        | -            | 250mA            |        | Kit |                    |               |         | RefFlow |         |
|                                   | 0.3  |  | BLM03BD241SN1                                | 240ohm±25%        | -            | 200mA            |        | Kit |                    |               |         | RefFlow |         |
|                                   | 0.3  |  | BLM03BD471SN1                                | 470ohm±25%        | -            | 215mA            |        | Kit |                    |               |         | RefFlow |         |
|                                   | 0.3  |  | BLM03BD601SN1                                | 600ohm±25%        | -            | 200mA            |        | Kit |                    |               |         | RefFlow |         |
|                                   | 0.3  |  | BLM03BB100SN1                                | 10ohm±25%         | -            | 300mA            |        | Kit |                    |               |         | RefFlow |         |
|                                   | 0.3  |  | BLM03BB220SN1                                | 22ohm±25%         | -            | 200mA            |        | Kit |                    |               |         | RefFlow |         |
|                                   | 0.3  |  | BLM03BB470SN1                                | 47ohm±25%         | -            | 200mA            |        | Kit |                    |               |         | RefFlow |         |
|                                   | 0.3  |  | BLM03BB750SN1                                | 75ohm±25%         | -            | 200mA            |        | Kit |                    |               |         | RefFlow |         |
|                                   | 0.3  |  | BLM03BB121SN1                                | 120ohm±25%        | -            | 100mA            |        | Kit |                    |               |         | RefFlow |         |
|                                   | 0.3  |  | BLM03BC330SN1                                | 33ohm±25%         | -            | 150mA            |        | Kit |                    |               |         | RefFlow |         |
|                                   | 0.3  |  | BLM03BC560SN1                                | 56ohm±25%         | -            | 100mA            |        | Kit |                    |               |         | RefFlow |         |
|                                   | 0.3  |  | BLM03BC800SN1                                | 80ohm±25%         | -            | 100mA            |        | Kit |                    |               |         | RefFlow |         |
|                                   | 0.3  |  | For Power Lines                              | p27 BLM03PG220SN1 | 22ohm±25%    | -                | 900mA  |     | Kit                |               |         |         | RefFlow |
|                                   | 0.3  |  |  | BLM03PG330SN1     | 33ohm±25%    | -                | 750mA  |     | Kit                |               |         |         | RefFlow |
|                                   | 0.3  | p28 BLM03PX220SN1                                      |  | 22ohm±25%         | -            | 1800mA           |        | Kit | ≥1A                |               |         | RefFlow |         |
|                                   | 0.3  | BLM03PX330SN1  |  | 33ohm±25%         | -            | 1500mA           |        | Kit | ≥1A                |               |         | RefFlow |         |
|                                   | 0.3  | BLM03PX800SN1  |  | 80ohm±25%         | -            | 1000mA           |        | Kit | ≥1A                |               |         | RefFlow |         |
|                                   | 0.3  | For GHz<br>Band Noise                                  |  | p85 BLM03HG601SN1 | 600ohm±25%   | 1000ohm±40%      | 150mA  |     | Kit                |               | GHz     |         | RefFlow |
|                                   | 0.3  |  | BLM03HG102SN1                                | 1000ohm±25%       | 1800ohm±40%  | 125mA            |        | Kit |                    | GHz           |         | RefFlow |         |
|                                   | 0.3  |  | BLM03HG122SN1                                | 1200ohm±25%       | 2000ohm±40%  | 100mA            | New    |     |                    | GHz           |         | RefFlow |         |
| 0.3                               | Universal Type<br>[Power lines/Signal lines] |  | p87 BLM03EB250SN1                            | 25ohm±25%         | 105ohm±40%   | 600mA            |        | Kit |                    | GHz           |         | RefFlow |         |
| 0.3                               |  |  | BLM03EB500SN1                                | 50ohm±25%         | 255ohm±40%   | 400mA            |        | Kit |                    | GHz           |         | RefFlow |         |
| 0.3                               |  |  | BLM03HD331SN1                                | 330ohm±25%        | 750ohm±40%   | 200mA            |        | Kit |                    | GHz           |         | RefFlow |         |
| 0.3                               | For High Speed<br>Signal Lines               |  | p85 BLM03HD471SN1                            | 470ohm±25%        | 1000ohm±40%  | 175mA            |        | Kit |                    | GHz           |         | RefFlow |         |
| 0.3                               |  |  | BLM03HD601SN1                                | 600ohm±25%        | 1500ohm±40%  | 150mA            |        | Kit |                    | GHz           |         | RefFlow |         |
| 0.3                               |  |  | BLM03HD102SN1                                | 1000ohm±25%       | 2300ohm±40%  | 120mA            |        | Kit |                    | GHz           |         | RefFlow |         |
| 0.3                               | BLM03HB191SN1                                | 190ohm±25%   | 1150ohm±40%                                  | 150mA             |              | Kit              |        | GHz |                    | RefFlow       |         |         |         |
| 0402<br>(1005)                    | 0.5  | For General Signal Lines                               | p42 BLM15AG100SN1                            | 10ohm(Typ.)       | -            | 1000mA           |        | Kit | ≥1A                |               |         | RefFlow |         |
|                                   | 0.5  |  | BLM15AG700SN1                                | 70ohm(Typ.)       | -            | 600mA            |        | Kit |                    |               |         | RefFlow |         |
|                                   | 0.5  |  | BLM15AG121SN1                                | 120ohm±25%        | -            | 550mA            |        | Kit |                    |               |         | RefFlow |         |
|                                   | 0.5  |  | BLM15AG221SN1                                | 220ohm±25%        | -            | 450mA            |        | Kit |                    |               |         | RefFlow |         |
|                                   | 0.5  |  | BLM15AG601SN1                                | 600ohm±25%        | -            | 300mA            |        | Kit |                    |               |         | RefFlow |         |
|                                   | 0.5  |  | BLM15AG102SN1                                | 1000ohm±25%       | -            | 300mA            |        | Kit |                    |               |         | RefFlow |         |
|                                   | 0.5  |  | Universal Type<br>[Power lines/Signal lines] | p40 BLM15AX100SN1 | 10ohm±5ohm   | -                | 1740mA |     | Kit                | ≥1A           |         |         | RefFlow |
|                                   | 0.5  | BLM15AX300SN1  |  | 30ohm±25%         | -            | 1100mA           |        | Kit | ≥1A                |               |         | RefFlow |         |
|                                   | 0.5  | BLM15AX700SN1  |  | 70ohm±25%         | -            | 780mA            |        | Kit |                    |               |         | RefFlow |         |
|                                   | 0.5  | BLM15AX121SN1  |  | 120ohm±25%        | -            | 700mA            |        | Kit |                    |               |         | RefFlow |         |
|                                   | 0.5  | BLM15AX221SN1  |  | 220ohm±25%        | -            | 600mA            |        | Kit |                    |               |         | RefFlow |         |
|                                   | 0.5  | BLM15AX601SN1  |  | 600ohm±25%        | -            | 500mA            |        | Kit |                    |               |         | RefFlow |         |
|                                   | 0.5  | BLM15AX102SN1  |  | 1000ohm±25%       | -            | 350mA            |        | Kit |                    |               |         | RefFlow |         |

Continued on the following page.

△Note • Please read rating and △CAUTION (for storage, operating, rating, soldering, mounting and handling) in this catalog to prevent smoking and/or burning, etc.  
• This catalog has only typical specifications. Therefore, please approve our product specifications or transact the approval sheet for product specifications before ordering.

Chip Ferrite Bead  
Chip EMIFIL®  
Chip Common Mode Choke Coil  
Block Type EMIFIL®  
Microwave Absorber

| Size Code<br>(in inch / in mm) | Thickness<br>(mm)     | Type   | Part Number   | Impedance                   |                          | Rated Current | New         | Kit        | ≥1A<br>≥3A<br>≥10A | GHz<br>Hi-GHz | Flow    | RefFlow |         |
|--------------------------------|-----------------------|--|---|-----------------------------|--------------------------|---------------|-------------|------------|--------------------|---------------|---------|---------|---------|
|                                |                       |  |   | at 100MHz/20°C              | at 1GHz/20°C             |               |             |            |                    |               |         |         |         |
| 0402<br>(1005)                 | 0.5                   | For High Speed Signal Lines<br>(Sharp Impedance Curve) | p44   | BLM15BX750SN1               | 75ohm±25%                | -             | 600mA       | Kit        |                    |               |         | RefFlow |         |
|                                | 0.5                   |  |   | BLM15BX121SN1               | 120ohm±25%               | -             | 600mA       | Kit        |                    |               |         | RefFlow |         |
|                                | 0.5                   |  | BLM15BX221SN1   | 220ohm±25%                  | -                        | 450mA         | Kit         |            |                    |               | RefFlow |         |         |
|                                | 0.5                   |  | BLM15BX471SN1   | 470ohm±25%                  | -                        | 350mA         | Kit         |            |                    |               | RefFlow |         |         |
|                                | 0.5                   |  | BLM15BX601SN1   | 600ohm±25%                  | -                        | 350mA         | Kit         |            |                    |               | RefFlow |         |         |
|                                | 0.5                   |  | BLM15BX102SN1   | 1000ohm±25%                 | -                        | 300mA         | Kit         |            |                    |               | RefFlow |         |         |
|                                | 0.5                   |  | BLM15BX182SN1   | 1800ohm±25%                 | -                        | 250mA         | Kit         |            |                    |               | RefFlow |         |         |
|                                | 0.5                   |  | p46   | BLM15BD750SN1               | 75ohm±25%                | -             | 300mA       | Kit        |                    |               |         | RefFlow |         |
|                                | 0.5                   |  |   | BLM15BD121SN1               | 120ohm±25%               | -             | 300mA       | Kit        |                    |               |         | RefFlow |         |
|                                | 0.5                   |  | BLM15BD221SN1   | 220ohm±25%                  | -                        | 300mA         | Kit         |            |                    |               | RefFlow |         |         |
|                                | 0.5                   |  | BLM15BD471SN1   | 470ohm±25%                  | -                        | 200mA         | Kit         |            |                    |               | RefFlow |         |         |
|                                | 0.5                   |  | BLM15BD601SN1   | 600ohm±25%                  | -                        | 200mA         | Kit         |            |                    |               | RefFlow |         |         |
|                                | 0.5                   |  | BLM15BD102SN1   | 1000ohm±25%                 | -                        | 200mA         | Kit         |            |                    |               | RefFlow |         |         |
|                                | 0.5                   |  | BLM15BD182SN1   | 1800ohm±25%                 | -                        | 100mA         | Kit         |            |                    |               | RefFlow |         |         |
|                                | 0.5                   |  | BLM15BB050SN1   | 5ohm±25%                    | -                        | 500mA         | Kit         |            |                    |               | RefFlow |         |         |
|                                | 0.5                   |  | BLM15BB100SN1   | 10ohm±25%                   | -                        | 300mA         | Kit         |            |                    |               | RefFlow |         |         |
|                                | 0.5                   |  | BLM15BB220SN1   | 22ohm±25%                   | -                        | 300mA         | Kit         |            |                    |               | RefFlow |         |         |
|                                | 0.5                   |  | BLM15BB470SN1   | 47ohm±25%                   | -                        | 300mA         | Kit         |            |                    |               | RefFlow |         |         |
|                                | 0.5                   |  | BLM15BB750SN1   | 75ohm±25%                   | -                        | 300mA         | Kit         |            |                    |               | RefFlow |         |         |
|                                | 0.5                   |  | BLM15BB121SN1   | 120ohm±25%                  | -                        | 300mA         | Kit         |            |                    |               | RefFlow |         |         |
|                                | 0.5                   |  | BLM15BB221SN1   | 220ohm±25%                  | -                        | 200mA         | Kit         |            |                    |               | RefFlow |         |         |
|                                | 0.5                   |  | BLM15BC121SN1   | 120ohm±25%                  | -                        | 350mA         | Kit         |            |                    |               | RefFlow |         |         |
|                                | 0.5                   |  | BLM15BC241SN1   | 240ohm±25%                  | -                        | 250mA         | Kit         |            |                    |               | RefFlow |         |         |
|                                | 0.5                   |  | BLM15BA050SN1   | 5ohm±25%                    | -                        | 300mA         | Kit         |            |                    |               | RefFlow |         |         |
|                                | 0.5                   |  | BLM15BA100SN1   | 10ohm±25%                   | -                        | 300mA         | Kit         |            |                    |               | RefFlow |         |         |
|                                | 0.5                   |  | BLM15BA220SN1   | 22ohm±25%                   | -                        | 300mA         | Kit         |            |                    |               | RefFlow |         |         |
|                                | 0.5                   |  | BLM15BA330SN1   | 33ohm±25%                   | -                        | 300mA         | Kit         |            |                    |               | RefFlow |         |         |
|                                | 0.5                   |  | BLM15BA470SN1   | 47ohm±25%                   | -                        | 200mA         | Kit         |            |                    |               | RefFlow |         |         |
|                                | 0.5                   |  | BLM15BA750SN1   | 75ohm±25%                   | -                        | 200mA         | Kit         |            |                    |               | RefFlow |         |         |
|                                | 0.5                   |  | For Power Lines   | p36                         | BLM15PX330SN1            | 33ohm±25%     | -           | 3000mA     | Kit                | ≥3A           |         |         | RefFlow |
|                                | 0.5                   |  |   |                             | BLM15PX600SN1            | 60ohm±25%     | -           | 2500mA     | Kit                | ≥1A           |         |         | RefFlow |
|                                | 0.5                   |  |   | BLM15PX800SN1               | 80ohm±25%                | -             | 2300mA      | Kit        | ≥1A                |               |         | RefFlow |         |
|                                | 0.5                   |  |   | BLM15PX121SN1               | 120ohm±25%               | -             | 2000mA      | Kit        | ≥1A                |               |         | RefFlow |         |
|                                | 0.5                   |  |   | BLM15PX181SN1               | 180ohm±25%               | -             | 1500mA      | Kit        | ≥1A                |               |         | RefFlow |         |
|                                | 0.5                   |  |   | BLM15PX221SN1               | 220ohm±25%               | -             | 1400mA      | Kit        | ≥1A                |               |         | RefFlow |         |
|                                | 0.5                   |  |   | BLM15PX331SN1               | 330ohm±25%               | -             | 1200mA      | Kit        | ≥1A                |               |         | RefFlow |         |
|                                | 0.5                   |  |   | BLM15PX471SN1               | 470ohm±25%               | -             | 1000mA      | Kit        | ≥1A                |               |         | RefFlow |         |
|                                | 0.5                   |  |   | BLM15PX601SN1               | 600ohm±25%               | -             | 900mA       | Kit        |                    |               |         | RefFlow |         |
|                                | 0.5                   |  |   | p38                         | BLM15PG100SN1            | 10ohm(Typ.)   | -           | 1000mA     | Kit                | ≥1A           |         |         | RefFlow |
|                                | 0.5                   |  |   |                             | BLM15PD300SN1            | 30ohm±25%     | -           | 2200mA     | Kit                | ≥1A           |         |         | RefFlow |
| 0.5                            | BLM15PD600SN1         | 60ohm±25%  |   |                             | -                        | 1700mA        | Kit         | ≥1A        |                    |               | RefFlow |         |         |
| 0.5                            | BLM15PD800SN1         | 80ohm±25%  |   |                             | -                        | 1500mA        | Kit         | ≥1A        |                    |               | RefFlow |         |         |
| 0.5                            | BLM15PD121SN1         | 120ohm±25%   |   |                             | -                        | 1300mA        | Kit         | ≥1A        |                    |               | RefFlow |         |         |
| 0.5                            | For GHz<br>Band Noise | p88  | For General Signal Lines                                  | BLM15HG601SN1               | 600ohm±25%               | 1000ohm±40%   | 300mA       | Kit        | GHz                |               | RefFlow |         |         |
| 0.5                            |                       |  | BLM15HG102SN1   | 1000ohm±25%                 | 1400ohm±40%              | 250mA         | Kit         | GHz        |                    | RefFlow       |         |         |         |
| 0.5                            |                       | p88  | For High Speed<br>Signal Lines<br>(Sharp Impedance Curve) | BLM15HD601SN1               | 600ohm±25%               | 1400ohm±40%   | 300mA       | Kit        | GHz                |               | RefFlow |         |         |
| 0.5                            |                       |  |   | BLM15HD102SN1               | 1000ohm±25%              | 2000ohm±40%   | 250mA       | Kit        | GHz                |               | RefFlow |         |         |
| 0.5                            |                       |  |   | BLM15HD182SN1               | 1800ohm±25%              | 2700ohm±40%   | 200mA       | Kit        | GHz                |               | RefFlow |         |         |
| 0.5                            |                       |  |   | BLM15HB121SN1               | 120ohm±25%               | 500ohm±40%    | 300mA       | Kit        | GHz                |               | RefFlow |         |         |
| 0.5                            |                       |  |   | BLM15HB221SN1               | 220ohm±25%               | 900ohm±40%    | 250mA       | Kit        | GHz                |               | RefFlow |         |         |
| 0.5                            |                       |  |   | BLM15EG121SN1               | 120ohm±25%               | 145ohm(Typ.)  | 1500mA      | Kit        | ≥1A                | GHz           |         | RefFlow |         |
| 0.5                            |                       | p90  | Universal Type<br>[Power Lines/Signal Lines]              | BLM15EG221SN1               | 220ohm±25%               | 270ohm(Typ.)  | 700mA       | Kit        | GHz                |               | RefFlow |         |         |
| 0.5                            |                       |  |   | p91                         | For General Signal Lines | BLM15GG221SN1 | 220ohm±25%  | 600ohm±40% | 300mA              | Kit           | Hi-GHz  |         | RefFlow |
| 0.5                            | BLM15GG471SN1         |  |   |                             |                          | 470ohm±25%    | 1200ohm±40% | 200mA      | Kit                | Hi-GHz        |         | RefFlow |         |
| 0.5                            | p91                   |  |   | For High Speed Signal Lines | BLM15GA750SN1            | 75ohm±25%     | 1000ohm±40% | 200mA      | Kit                | Hi-GHz        |         | RefFlow |         |

Continued on the following page. ↗

⚠Note • Please read rating and ⚠CAUTION (for storage, operating, rating, soldering, mounting and handling) in this catalog to prevent smoking and/or burning, etc.  
• This catalog has only typical specifications. Therefore, please approve our product specifications or transact the approval sheet for product specifications before ordering.

| Size Code<br>(in inch<br>(in mm)) | Thickness<br>(mm) | Type                        | Part Number  | Impedance         |              | Rated Current | New   | Kit | ≥1A<br>≥3A<br>≥10A | GHz  | Flow    | RefFlow |         |
|-----------------------------------|-------------------|-----------------------------|--|-------------------|--------------|---------------|-------|-----|--------------------|------|---------|---------|---------|
|                                   |                   |                             |  | at 100MHz/20°C    | at 1GHz/20°C |               |       |     |                    |      |         |         |         |
| 0603<br>(1608)                    | 0.8               | For General Signal Lines    | p56 BLM18AG121SN1                                      | 120ohm±25%        | -            | 500mA         |       | Kit |                    |      | Flow    | RefFlow |         |
|                                   | 0.8               |                             | p56 BLM18AG151SN1                                      | 150ohm±25%        | -            | 500mA         |       | Kit |                    |      | Flow    | RefFlow |         |
|                                   | 0.8               |                             | p56 BLM18AG221SN1                                      | 220ohm±25%        | -            | 500mA         |       | Kit |                    |      | Flow    | RefFlow |         |
|                                   | 0.8               |                             | p56 BLM18AG331SN1                                      | 330ohm±25%        | -            | 500mA         |       | Kit |                    |      | Flow    | RefFlow |         |
|                                   | 0.8               |                             | p56 BLM18AG471SN1                                      | 470ohm±25%        | -            | 500mA         |       | Kit |                    |      | Flow    | RefFlow |         |
|                                   | 0.8               |                             | p56 BLM18AG601SN1                                      | 600ohm±25%        | -            | 500mA         |       | Kit |                    |      | Flow    | RefFlow |         |
|                                   | 0.8               |                             | p56 BLM18AG102SN1                                      | 1000ohm±25%       | -            | 400mA         |       | Kit |                    |      | Flow    | RefFlow |         |
|                                   | 0.6               |                             | p62  | p62 BLM18TG121TN1 | 120ohm±25%   | -             | 200mA |     |                    |      |         | Flow    | RefFlow |
|                                   | 0.6               |                             |  | p62 BLM18TG221TN1 | 220ohm±25%   | -             | 200mA |     |                    |      |         | Flow    | RefFlow |
|                                   | 0.6               |                             |  | p62 BLM18TG601TN1 | 600ohm±25%   | -             | 200mA |     |                    |      |         | Flow    | RefFlow |
|                                   | 0.6               |                             |  | p62 BLM18TG102TN1 | 1000ohm±25%  | -             | 100mA |     |                    |      |         | Flow    | RefFlow |
|                                   | 0.8               |                             | For High Speed Signal Lines<br>(Sharp Impedance Curve) | p58 BLM18BD470SN1 | 47ohm±25%    | -             | 500mA |     | Kit                |      |         | Flow    | RefFlow |
|                                   | 0.8               |                             |  | p58 BLM18BD121SN1 | 120ohm±25%   | -             | 200mA |     | Kit                |      |         | Flow    | RefFlow |
|                                   | 0.8               |                             |  | p58 BLM18BD151SN1 | 150ohm±25%   | -             | 200mA |     | Kit                |      |         | Flow    | RefFlow |
|                                   | 0.8               |                             |  | p58 BLM18BD221SN1 | 220ohm±25%   | -             | 200mA |     | Kit                |      |         | Flow    | RefFlow |
|                                   | 0.8               | p58 BLM18BD331SN1           |  | 330ohm±25%        | -            | 200mA         |       | Kit |                    |      | Flow    | RefFlow |         |
|                                   | 0.8               | p58 BLM18BD421SN1           |  | 420ohm±25%        | -            | 200mA         |       | Kit |                    |      | Flow    | RefFlow |         |
|                                   | 0.8               | p58 BLM18BD471SN1           |  | 470ohm±25%        | -            | 200mA         |       | Kit |                    |      | Flow    | RefFlow |         |
|                                   | 0.8               | p58 BLM18BD601SN1           |  | 600ohm±25%        | -            | 200mA         |       | Kit |                    |      | Flow    | RefFlow |         |
|                                   | 0.8               | p58 BLM18BD102SN1           |  | 1000ohm±25%       | -            | 100mA         |       | Kit |                    |      | Flow    | RefFlow |         |
|                                   | 0.8               | p58 BLM18BD152SN1           |  | 1500ohm±25%       | -            | 50mA          |       | Kit |                    |      | Flow    | RefFlow |         |
|                                   | 0.8               | p58 BLM18BD182SN1           |  | 1800ohm±25%       | -            | 50mA          |       | Kit |                    |      | Flow    | RefFlow |         |
|                                   | 0.8               | p58 BLM18BD222SN1           |  | 2200ohm±25%       | -            | 50mA          |       | Kit |                    |      | Flow    | RefFlow |         |
|                                   | 0.8               | p58 BLM18BD252SN1           |  | 2500ohm±25%       | -            | 50mA          |       | Kit |                    |      | Flow    | RefFlow |         |
|                                   | 0.8               | p58 BLM18BB050SN1           |  | 5ohm±25%          | -            | 700mA         |       | Kit |                    |      | Flow    | RefFlow |         |
|                                   | 0.8               | p58 BLM18BB100SN1           |  | 10ohm±25%         | -            | 700mA         |       | Kit |                    |      | Flow    | RefFlow |         |
|                                   | 0.8               | p58 BLM18BB220SN1           |  | 22ohm±25%         | -            | 600mA         |       | Kit |                    |      | Flow    | RefFlow |         |
|                                   | 0.8               | p58 BLM18BB470SN1           |  | 47ohm±25%         | -            | 550mA         |       | Kit |                    |      | Flow    | RefFlow |         |
|                                   | 0.8               | p58 BLM18BB600SN1           |  | 60ohm±25%         | -            | 550mA         |       | Kit |                    |      | Flow    | RefFlow |         |
|                                   | 0.8               | p58 BLM18BB750SN1           |  | 75ohm±25%         | -            | 500mA         |       | Kit |                    |      | Flow    | RefFlow |         |
|                                   | 0.8               | p58 BLM18BB121SN1           |  | 120ohm±25%        | -            | 500mA         |       | Kit |                    |      | Flow    | RefFlow |         |
|                                   | 0.8               | p58 BLM18BB141SN1           |  | 140ohm±25%        | -            | 450mA         |       |     |                    |      | Flow    | RefFlow |         |
|                                   | 0.8               | p58 BLM18BB151SN1           |  | 150ohm±25%        | -            | 450mA         |       | Kit |                    |      | Flow    | RefFlow |         |
|                                   | 0.8               | p58 BLM18BB221SN1           |  | 220ohm±25%        | -            | 450mA         |       | Kit |                    |      | Flow    | RefFlow |         |
|                                   | 0.8               | p58 BLM18BB331SN1           |  | 330ohm±25%        | -            | 400mA         |       | Kit |                    |      | Flow    | RefFlow |         |
|                                   | 0.8               | p58 BLM18BB471SN1           |  | 470ohm±25%        | -            | 300mA         |       | Kit |                    |      | Flow    | RefFlow |         |
|                                   | 0.8               | p58 BLM18BA050SN1           |  | 5ohm±25%          | -            | 500mA         |       | Kit |                    |      | Flow    | RefFlow |         |
|                                   | 0.8               | p58 BLM18BA100SN1           |  | 10ohm±25%         | -            | 500mA         |       | Kit |                    |      | Flow    | RefFlow |         |
|                                   | 0.8               | p58 BLM18BA220SN1           |  | 22ohm±25%         | -            | 500mA         |       |     |                    |      | Flow    | RefFlow |         |
|                                   | 0.8               | p58 BLM18BA470SN1           |  | 47ohm±25%         | -            | 300mA         |       | Kit |                    |      | Flow    | RefFlow |         |
|                                   | 0.8               | p58 BLM18BA750SN1           |  | 75ohm±25%         | -            | 300mA         |       | Kit |                    |      | Flow    | RefFlow |         |
|                                   | 0.8               | p58 BLM18BA121SN1           | 120ohm±25%   | -                 | 200mA        |               | Kit   |     |                    | Flow | RefFlow |         |         |
|                                   | 0.8               | For Digital Interface Lines | p63 BLM18RK121SN1                                      | 120ohm±25%        | -            | 200mA         |       |     |                    |      | Flow    | RefFlow |         |
|                                   | 0.8               |                             | p63 BLM18RK221SN1                                      | 220ohm±25%        | -            | 200mA         |       |     |                    |      | Flow    | RefFlow |         |
|                                   | 0.8               |                             | p63 BLM18RK471SN1                                      | 470ohm±25%        | -            | 200mA         |       |     |                    |      | Flow    | RefFlow |         |
| 0.8                               | p63 BLM18RK601SN1 |                             | 600ohm±25%   | -                 | 200mA        |               |       |     |                    | Flow | RefFlow |         |         |
| 0.8                               | p63 BLM18RK102SN1 |                             | 1000ohm±25%  | -                 | 200mA        |               |       |     |                    | Flow | RefFlow |         |         |

Continued on the following page. ↗

△Note • Please read rating and △CAUTION (for storage, operating, rating, soldering, mounting and handling) in this catalog to prevent smoking and/or burning, etc.  
 • This catalog has only typical specifications. Therefore, please approve our product specifications or transact the approval sheet for product specifications before ordering.

Chip Ferrite Bead  
Chip EMIFIL®  
Chip Common Mode Choke Coil  
Block Type EMIFIL®  
Microwave Absorber

| Size Code<br>(in mm) | Thickness<br>(mm)       | Type                                      | Part Number   | Impedance                   |                   | Rated Current | New        | Kit    | ≥1A<br>≥3A<br>≥10A | GHz<br>Hz        | F <sub>low</sub>   | R <sub>eflow</sub> |                    |                    |
|----------------------|-------------------------|---|---|-----------------------------|-------------------|---------------|------------|--------|--------------------|------------------|--------------------|--------------------|--------------------|--------------------|
|                      |                         |   |   | at 100MHz/20°C              | at 1GHz/20°C      |               |            |        |                    |                  |                    |                    |                    |                    |
| 6003<br>(1608)       | 0.8                     | Standard Type                             | p50 BLM18PG300SN1                                   | 30ohm(Typ.)                 | -                 | 1000mA        | Kit        | ≥1A    |                    |                  | F <sub>low</sub>   | R <sub>eflow</sub> |                    |                    |
|                      | 0.8                     |   | p50 BLM18PG330SN1                                   | 33ohm±25%                   | -                 | 3000mA        | Kit        | ≥3A    |                    |                  | F <sub>low</sub>   | R <sub>eflow</sub> |                    |                    |
|                      | 0.8                     |   | p50 BLM18PG600SN1                                   | 60ohm(Typ.)                 | -                 | 500mA         | Kit        |        |                    |                  | F <sub>low</sub>   | R <sub>eflow</sub> |                    |                    |
|                      | 0.8                     |   | p50 BLM18PG121SN1                                   | 120ohm±25%                  | -                 | 2000mA        | Kit        | ≥1A    |                    |                  | F <sub>low</sub>   | R <sub>eflow</sub> |                    |                    |
|                      | 0.8                     |   | p50 BLM18PG181SN1                                   | 180ohm±25%                  | -                 | 1500mA        | Kit        | ≥1A    |                    |                  | F <sub>low</sub>   | R <sub>eflow</sub> |                    |                    |
|                      | 0.8                     |   | p50 BLM18PG221SN1                                   | 220ohm±25%                  | -                 | 1400mA        | Kit        | ≥1A    |                    |                  | F <sub>low</sub>   | R <sub>eflow</sub> |                    |                    |
|                      | 0.8                     |   | p50 BLM18PG331SN1                                   | 330ohm±25%                  | -                 | 1200mA        | Kit        | ≥1A    |                    |                  | F <sub>low</sub>   | R <sub>eflow</sub> |                    |                    |
|                      | 0.8                     |   | p50 BLM18PG471SN1                                   | 470ohm±25%                  | -                 | 1000mA        | Kit        | ≥1A    |                    |                  | F <sub>low</sub>   | R <sub>eflow</sub> |                    |                    |
|                      | 0.6                     |   | For Power Lines                                     | p52 BLM18KG260TN1           | 26ohm±25%         | -             | 6000mA     | Kit    | ≥3A                |                  |                    | F <sub>low</sub>   | R <sub>eflow</sub> |                    |
|                      | 0.6                     |   |   | p52 BLM18KG300TN1           | 30ohm±25%         | -             | 5000mA     | Kit    | ≥3A                |                  |                    | F <sub>low</sub>   | R <sub>eflow</sub> |                    |
|                      | 0.6                     |   |   | p52 BLM18KG700TN1           | 70ohm±25%         | -             | 3500mA     | Kit    | ≥3A                |                  |                    | F <sub>low</sub>   | R <sub>eflow</sub> |                    |
|                      | 0.6                     |   |   | p52 BLM18KG101TN1           | 100ohm±25%        | -             | 3000mA     | Kit    | ≥3A                |                  |                    | F <sub>low</sub>   | R <sub>eflow</sub> |                    |
|                      | 0.6                     |   |   | p52 BLM18KG121TN1           | 120ohm±25%        | -             | 3000mA     | Kit    | ≥3A                |                  |                    | F <sub>low</sub>   | R <sub>eflow</sub> |                    |
|                      | 0.8                     |   |   | p52 BLM18KG221SN1           | 220ohm±25%        | -             | 2200mA     | Kit    | ≥1A                |                  |                    | F <sub>low</sub>   | R <sub>eflow</sub> |                    |
|                      | 0.8                     | Low DC Resistance Type                    |   | p52 BLM18KG331SN1           | 330ohm±25%        | -             | 1700mA     | Kit    | ≥1A                |                  |                    | F <sub>low</sub>   | R <sub>eflow</sub> |                    |
|                      | 0.8                     |   |   | p52 BLM18KG471SN1           | 470ohm±25%        | -             | 1500mA     | Kit    | ≥1A                |                  |                    | F <sub>low</sub>   | R <sub>eflow</sub> |                    |
|                      | 0.8                     |   |   | p52 BLM18KG601SN1           | 600ohm±25%        | -             | 1300mA     | Kit    | ≥1A                |                  |                    | F <sub>low</sub>   | R <sub>eflow</sub> |                    |
|                      | 0.5                     |   |   | p54                         | p54 BLM18SG260TN1 | 26ohm±25%     | -          | 6000mA | Kit                | ≥3A              |                    |                    | F <sub>low</sub>   | R <sub>eflow</sub> |
|                      | 0.5                     |   |   |                             | p54 BLM18SG700TN1 | 70ohm±25%     | -          | 4000mA | Kit                | ≥3A              |                    |                    | F <sub>low</sub>   | R <sub>eflow</sub> |
|                      | 0.5                     |   |   |                             | p54 BLM18SG121TN1 | 120ohm±25%    | -          | 3000mA | Kit                | ≥3A              |                    |                    | F <sub>low</sub>   | R <sub>eflow</sub> |
|                      | 0.5                     | p54 BLM18SG221TN1                         |   |                             | 220ohm±25%        | -             | 2500mA     | Kit    | ≥1A                |                  |                    | F <sub>low</sub>   | R <sub>eflow</sub> |                    |
|                      | 0.5                     | p54 BLM18SG331TN1                         |   |                             | 330ohm±25%        | -             | 1500mA     | Kit    | ≥1A                |                  |                    | F <sub>low</sub>   | R <sub>eflow</sub> |                    |
|                      | 0.8                     | For GHz Band Noise                        | p92 BLM18HG471SN1                                   |                             | 470ohm±25%        | 600ohm(Typ.)  | 200mA      | Kit    |                    | GHz              |                    | F <sub>low</sub>   | R <sub>eflow</sub> |                    |
|                      | 0.8                     |   | p92 BLM18HG601SN1                                   |                             | 600ohm±25%        | 700ohm(Typ.)  | 200mA      | Kit    |                    | GHz              |                    | F <sub>low</sub>   | R <sub>eflow</sub> |                    |
|                      | 0.8                     |   | p92 BLM18HG102SN1                                   |                             | 1000ohm±25%       | 1000ohm(Typ.) | 100mA      | Kit    |                    | GHz              |                    | F <sub>low</sub>   | R <sub>eflow</sub> |                    |
|                      | 0.8                     |   | For High Speed Signal Lines (Sharp Impedance Curve) | p92 BLM18HE601SN1           | 600ohm±25%        | 600ohm(Typ.)  | 800mA      | Kit    |                    | GHz              |                    | F <sub>low</sub>   | R <sub>eflow</sub> |                    |
|                      | 0.8                     |   |   | p92 BLM18HE102SN1           | 1000ohm±25%       | 1000ohm(Typ.) | 600mA      | Kit    |                    | GHz              |                    | F <sub>low</sub>   | R <sub>eflow</sub> |                    |
|                      | 0.8                     |   |   | p92 BLM18HE152SN1           | 1500ohm±25%       | 1500ohm(Typ.) | 500mA      | Kit    |                    | GHz              |                    | F <sub>low</sub>   | R <sub>eflow</sub> |                    |
|                      | 0.8                     |   |   | p92 BLM18HD471SN1           | 470ohm±25%        | 1000ohm(Typ.) | 100mA      | Kit    |                    | GHz              |                    | F <sub>low</sub>   | R <sub>eflow</sub> |                    |
|                      | 0.8                     |   |   | p92 BLM18HD601SN1           | 600ohm±25%        | 1200ohm(Typ.) | 100mA      | Kit    |                    | GHz              |                    | F <sub>low</sub>   | R <sub>eflow</sub> |                    |
|                      | 0.8                     |   |   | p92 BLM18HD102SN1           | 1000ohm±25%       | 1700ohm(Typ.) | 50mA       | Kit    |                    | GHz              |                    | F <sub>low</sub>   | R <sub>eflow</sub> |                    |
|                      | 0.8                     |   |   | p92 BLM18HB121SN1           | 120ohm±25%        | 500ohm±40%    | 200mA      | Kit    |                    | GHz              |                    | F <sub>low</sub>   | R <sub>eflow</sub> |                    |
|                      | 0.8                     |   |   | p92 BLM18HB221SN1           | 220ohm±25%        | 1100ohm±40%   | 100mA      | Kit    |                    | GHz              |                    | F <sub>low</sub>   | R <sub>eflow</sub> |                    |
|                      | 0.8                     |   |   | p92 BLM18HB331SN1           | 330ohm±25%        | 1600ohm±40%   | 50mA       | Kit    |                    | GHz              |                    | F <sub>low</sub>   | R <sub>eflow</sub> |                    |
|                      | 0.8                     |   |   | For Digital Interface Lines | p92 BLM18HK331SN1 | 330ohm±25%    | 400ohm±40% | 200mA  | Kit                |                  | GHz                |                    | F <sub>low</sub>   | R <sub>eflow</sub> |
|                      | 0.8                     |   | p92 BLM18HK471SN1                                   |                             | 470ohm±25%        | 600ohm±40%    | 200mA      | Kit    |                    | GHz              |                    | F <sub>low</sub>   | R <sub>eflow</sub> |                    |
|                      | 0.8                     | p92 BLM18HK601SN1                         | 600ohm±25%  |                             | 700ohm±40%        | 100mA         | Kit        |        | GHz                |                  | F <sub>low</sub>   | R <sub>eflow</sub> |                    |                    |
|                      | 0.8                     | p92 BLM18HK102SN1                         | 1000ohm±25%   |                             | 1200ohm±40%       | 50mA          | Kit        |        | GHz                |                  | F <sub>low</sub>   | R <sub>eflow</sub> |                    |                    |
|                      | 0.5                     | Universal Type [Power lines/Signal lines] | p96 BLM18EG101TN1                                   | 100ohm±25%                  | 140ohm(Typ.)      | 2000mA        | Kit        | ≥1A    | GHz                |                  | F <sub>low</sub>   | R <sub>eflow</sub> |                    |                    |
|                      | 0.8                     |   | p96 BLM18EG121SN1                                   | 120ohm±25%                  | 145ohm(Typ.)      | 2000mA        | Kit        | ≥1A    | GHz                |                  | F <sub>low</sub>   | R <sub>eflow</sub> |                    |                    |
| 0.8                  | p96 BLM18EG221SN1       |   | 220ohm±25%  | 260ohm(Typ.)                | 2000mA            | Kit           | ≥1A        | GHz    |                    | F <sub>low</sub> | R <sub>eflow</sub> |                    |                    |                    |
| 0.5                  | p96 BLM18EG221TN1       |   | 220ohm±25%  | 300ohm(Typ.)                | 1000mA            | Kit           | ≥1A        | GHz    |                    | F <sub>low</sub> | R <sub>eflow</sub> |                    |                    |                    |
| 0.5                  | p96 BLM18EG331TN1       |   | 330ohm±25%  | 450ohm(Typ.)                | 500mA             | Kit           |            | GHz    |                    | F <sub>low</sub> | R <sub>eflow</sub> |                    |                    |                    |
| 0.5                  | p96 BLM18EG391TN1       |   | 390ohm±25%  | 520ohm(Typ.)                | 500mA             | Kit           |            | GHz    |                    | F <sub>low</sub> | R <sub>eflow</sub> |                    |                    |                    |
| 0.8                  | p96 BLM18EG471SN1       |   | 470ohm±25%  | 550ohm(Typ.)                | 500mA             | Kit           |            | GHz    |                    | F <sub>low</sub> | R <sub>eflow</sub> |                    |                    |                    |
| 0.8                  | p96 BLM18EG601SN1       |   | 600ohm±25%  | 700ohm(Typ.)                | 500mA             | Kit           |            | GHz    |                    | F <sub>low</sub> | R <sub>eflow</sub> |                    |                    |                    |
| 0.8                  | For High-GHz Band Noise |   | p98 BLM18GG471SN1                                   | 470ohm±25%                  | 1800ohm±30%       | 200mA         | Kit        |        | Hz                 |                  | F <sub>low</sub>   | R <sub>eflow</sub> |                    |                    |
| 0.8                  |                         |   | p98 BLM18GG601SN1                                   | 600ohm±25%                  | 1800ohm±30%       | 200mA         | Kit        |        | Hz                 |                  | F <sub>low</sub>   | R <sub>eflow</sub> |                    |                    |
| 0805<br>(2012)       | 0.85                    | For General Signal Lines                  | p68 BLM21AG121SN1                                   | 120ohm±25%                  | -                 | 800mA         | Kit        |        |                    |                  | F <sub>low</sub>   | R <sub>eflow</sub> |                    |                    |
|                      | 0.85                    |   | p68 BLM21AG151SN1                                   | 150ohm±25%                  | -                 | 800mA         | Kit        |        |                    |                  | F <sub>low</sub>   | R <sub>eflow</sub> |                    |                    |
|                      | 0.85                    |   | p68 BLM21AG221SN1                                   | 220ohm±25%                  | -                 | 800mA         | Kit        |        |                    |                  | F <sub>low</sub>   | R <sub>eflow</sub> |                    |                    |
|                      | 0.85                    |   | p68 BLM21AG331SN1                                   | 330ohm±25%                  | -                 | 700mA         | Kit        |        |                    |                  | F <sub>low</sub>   | R <sub>eflow</sub> |                    |                    |
|                      | 0.85                    |   | p68 BLM21AG471SN1                                   | 470ohm±25%                  | -                 | 700mA         | Kit        |        |                    |                  | F <sub>low</sub>   | R <sub>eflow</sub> |                    |                    |
|                      | 0.85                    |   | p68 BLM21AG601SN1                                   | 600ohm±25%                  | -                 | 600mA         | Kit        |        |                    |                  | F <sub>low</sub>   | R <sub>eflow</sub> |                    |                    |
|                      | 0.85                    |   | p68 BLM21AG102SN1                                   | 1000ohm±25%                 | -                 | 500mA         | Kit        |        |                    |                  | F <sub>low</sub>   | R <sub>eflow</sub> |                    |                    |

Continued on the following page.

△Note • Please read rating and △CAUTION (for storage, operating, rating, soldering, mounting and handling) in this catalog to prevent smoking and/or burning, etc.  
• This catalog has only typical specifications. Therefore, please approve our product specifications or transact the approval sheet for product specifications before ordering.

BL Chip Ferrite Bead Series Line Up

| Size Code<br>(in mm) | Thickness<br>(mm)           | Type   | Part Number       | Impedance      |              | Rated Current | New | Kit        | $\geq 1A$<br>$\geq 3A$<br>$\geq 10A$ | GHz  | Flow    | RefFlow |         |
|----------------------|-----------------------------|--|-------------------|----------------|--------------|---------------|-----|------------|--------------------------------------|------|---------|---------|---------|
|                      |                             |  |                   | at 100MHz/20°C | at 1GHz/20°C |               |     |            |                                      |      |         |         |         |
| 0805<br>(2012)       | 0.85                        | For High Speed Signal Lines<br>(Sharp Impedance Curve) | p70 BLM21BD121SN1 | 120ohm±25%     | -            | 200mA         |     | Kit        |                                      |      | Flow    | RefFlow |         |
|                      | 0.85                        |  | BLM21BD151SN1     | 150ohm±25%     | -            | 200mA         |     |            |                                      |      | Flow    | RefFlow |         |
|                      | 0.85                        |  | BLM21BD221SN1     | 220ohm±25%     | -            | 200mA         |     | Kit        |                                      |      | Flow    | RefFlow |         |
|                      | 0.85                        |  | BLM21BD331SN1     | 330ohm±25%     | -            | 200mA         |     |            |                                      |      | Flow    | RefFlow |         |
|                      | 0.85                        |  | BLM21BD421SN1     | 420ohm±25%     | -            | 200mA         |     | Kit        |                                      |      | Flow    | RefFlow |         |
|                      | 0.85                        |  | BLM21BD471SN1     | 470ohm±25%     | -            | 200mA         |     | Kit        |                                      |      | Flow    | RefFlow |         |
|                      | 0.85                        |  | BLM21BD601SN1     | 600ohm±25%     | -            | 200mA         |     | Kit        |                                      |      | Flow    | RefFlow |         |
|                      | 0.85                        |  | BLM21BD751SN1     | 750ohm±25%     | -            | 200mA         |     |            |                                      |      | Flow    | RefFlow |         |
|                      | 0.85                        |  | BLM21BD102SN1     | 1000ohm±25%    | -            | 200mA         |     | Kit        |                                      |      | Flow    | RefFlow |         |
|                      | 0.85                        |  | BLM21BD152SN1     | 1500ohm±25%    | -            | 200mA         |     | Kit        |                                      |      | Flow    | RefFlow |         |
|                      | 0.85                        |  | BLM21BD182SN1     | 1800ohm±25%    | -            | 200mA         |     | Kit        |                                      |      | Flow    | RefFlow |         |
|                      | 0.85                        |  | BLM21BD222TN1     | 2200ohm±25%    | -            | 200mA         |     | Kit        |                                      |      | Flow    | RefFlow |         |
|                      | 1.25                        |  | BLM21BD222SN1     | 2250ohm(Typ.)  | -            | 200mA         |     | Kit        |                                      |      |         | Flow    | RefFlow |
|                      | 1.25                        |  | BLM21BD272SN1     | 2700ohm±25%    | -            | 200mA         |     | Kit        |                                      |      |         | Flow    | RefFlow |
|                      | 0.85                        |  | BLM21BB050SN1     | 5ohm±25%       | -            | 1000mA        |     | Kit        |                                      |      |         | Flow    | RefFlow |
|                      | 0.85                        |  | BLM21BB600SN1     | 60ohm±25%      | -            | 800mA         |     | Kit        |                                      |      |         | Flow    | RefFlow |
|                      | 0.85                        |  | BLM21BB750SN1     | 75ohm±25%      | -            | 700mA         |     | Kit        |                                      |      |         | Flow    | RefFlow |
|                      | 0.85                        |  | BLM21BB121SN1     | 120ohm±25%     | -            | 600mA         |     | Kit        |                                      |      |         | Flow    | RefFlow |
|                      | 0.85                        |  | BLM21BB151SN1     | 150ohm±25%     | -            | 600mA         |     |            |                                      |      |         | Flow    | RefFlow |
|                      | 0.85                        |  | BLM21BB201SN1     | 200ohm±25%     | -            | 500mA         |     |            |                                      |      |         | Flow    | RefFlow |
| 0.85                 | BLM21BB221SN1               | 220ohm±25%   | -                 | 500mA          |              | Kit           |     |            |                                      | Flow | RefFlow |         |         |
| 0.85                 | BLM21BB331SN1               | 330ohm±25%   | -                 | 400mA          |              | Kit           |     |            |                                      | Flow | RefFlow |         |         |
| 0.85                 | BLM21BB471SN1               | 470ohm±25%   | -                 | 400mA          |              | Kit           |     |            |                                      | Flow | RefFlow |         |         |
| 0.85                 | For Digital Interface Lines | p73 BLM21RK121SN1                                      | 120ohm±25%        | -              | 200mA        |               |     |            |                                      | Flow | RefFlow |         |         |
| 0.85                 |                             | BLM21RK221SN1  | 220ohm±25%        | -              | 200mA        |               |     |            |                                      | Flow | RefFlow |         |         |
| 0.85                 |                             | BLM21RK471SN1  | 470ohm±25%        | -              | 200mA        |               |     |            |                                      | Flow | RefFlow |         |         |
| 0.85                 |                             | BLM21RK601SN1  | 600ohm±25%        | -              | 200mA        |               |     |            |                                      | Flow | RefFlow |         |         |
| 0.85                 |                             | BLM21RK102SN1  | 1000ohm±25%       | -              | 200mA        |               |     |            |                                      | Flow | RefFlow |         |         |
| 0.85                 | For Power Lines             | p66 BLM21PG220SN1                                      | 22ohm±25%         | -              | 6000mA       |               | Kit | $\geq 3A$  |                                      | Flow | RefFlow |         |         |
| 0.85                 |                             | BLM21PG300SN1  | 30ohm(Typ.)       | -              | 4000mA       |               | Kit | $\geq 3A$  |                                      | Flow | RefFlow |         |         |
| 0.85                 |                             | BLM21PG600SN1  | 60ohm±25%         | -              | 3500mA       |               | Kit | $\geq 3A$  |                                      | Flow | RefFlow |         |         |
| 0.85                 |                             | BLM21PG121SN1  | 120ohm±25%        | -              | 3000mA       |               | Kit | $\geq 3A$  |                                      | Flow | RefFlow |         |         |
| 0.85                 |                             | BLM21PG221SN1  | 220ohm±25%        | -              | 2000mA       |               | Kit | $\geq 1A$  |                                      | Flow | RefFlow |         |         |
| 0.85                 |                             | BLM21PG331SN1  | 330ohm±25%        | -              | 1500mA       |               | Kit | $\geq 1A$  |                                      | Flow | RefFlow |         |         |
| 1.1                  | For Power Lines             | p75 BLM31PG330SN1                                      | 33ohm±25%         | -              | 6000mA       |               | Kit | $\geq 3A$  |                                      | Flow | RefFlow |         |         |
| 1.1                  |                             | BLM31PG500SN1  | 50ohm(Typ.)       | -              | 3500mA       |               | Kit | $\geq 3A$  |                                      | Flow | RefFlow |         |         |
| 1.1                  |                             | BLM31PG121SN1  | 120ohm±25%        | -              | 3500mA       |               | Kit | $\geq 3A$  |                                      | Flow | RefFlow |         |         |
| 1.1                  |                             | BLM31PG391SN1  | 390ohm±25%        | -              | 2000mA       |               | Kit | $\geq 1A$  |                                      | Flow | RefFlow |         |         |
| 1.1                  |                             | BLM31PG601SN1  | 600ohm±25%        | -              | 1500mA       |               | Kit | $\geq 1A$  |                                      | Flow | RefFlow |         |         |
| 1.6                  | For Power Lines             | p77 BLM41PG600SN1                                      | 60ohm(Typ.)       | -              | 6000mA       |               | Kit | $\geq 3A$  |                                      | Flow | RefFlow |         |         |
| 1.6                  |                             | BLM41PG750SN1  | 75ohm(Typ.)       | -              | 3500mA       |               | Kit | $\geq 3A$  |                                      | Flow | RefFlow |         |         |
| 1.6                  |                             | BLM41PG181SN1  | 180ohm±25%        | -              | 3500mA       |               | Kit | $\geq 3A$  |                                      | Flow | RefFlow |         |         |
| 1.6                  |                             | BLM41PG471SN1  | 470ohm±25%        | -              | 2000mA       |               | Kit | $\geq 1A$  |                                      | Flow | RefFlow |         |         |
| 1.6                  |                             | BLM41PG102SN1  | 1000ohm±25%       | -              | 1500mA       |               | Kit | $\geq 1A$  |                                      | Flow | RefFlow |         |         |
| 1210<br>(3225)       | 0.2                         | For Power Lines  | p79 BLE32PN300SN1 | 30ohm±10ohm    | -            | 10000mA       | New | $\geq 10A$ |                                      | Flow | RefFlow |         |         |
| 0804<br>(2010)       | 0.5                         | For General Signal Lines                               | p80 BLA2AAG121SN4 | 120ohm±25%     | -            | 100mA         |     |            |                                      |      | RefFlow |         |         |
|                      | 0.5                         |  | BLA2AAG221SN4     | 220ohm±25%     | -            | 50mA          |     |            |                                      |      | RefFlow |         |         |
|                      | 0.5                         |  | BLA2AAG601SN4     | 600ohm±25%     | -            | 50mA          |     |            |                                      |      | RefFlow |         |         |
|                      | 0.5                         |  | BLA2AAG102SN4     | 1000ohm±25%    | -            | 50mA          |     |            |                                      |      | RefFlow |         |         |
|                      | 0.5                         | For High Speed Signal Lines                            | p80 BLA2ABD750SN4 | 75ohm±25%      | -            | 200mA         |     |            |                                      |      | RefFlow |         |         |
|                      | 0.5                         |  | BLA2ABD121SN4     | 120ohm±25%     | -            | 200mA         |     |            |                                      |      | RefFlow |         |         |
|                      | 0.5                         |  | BLA2ABD221SN4     | 220ohm±25%     | -            | 100mA         |     |            |                                      |      | RefFlow |         |         |
|                      | 0.5                         |  | BLA2ABD471SN4     | 470ohm±25%     | -            | 100mA         |     |            |                                      |      | RefFlow |         |         |
|                      | 0.5                         |  | BLA2ABD601SN4     | 600ohm±25%     | -            | 100mA         |     |            |                                      |      | RefFlow |         |         |
|                      | 0.5                         |  | BLA2ABD102SN4     | 1000ohm±25%    | -            | 50mA          |     |            |                                      |      | RefFlow |         |         |
|                      | 0.5                         |  | BLA2ABB100SN4     | 10ohm±25%      | -            | 200mA         |     |            |                                      |      | RefFlow |         |         |
|                      | 0.5                         |  | BLA2ABB220SN4     | 22ohm±25%      | -            | 200mA         |     |            |                                      |      | RefFlow |         |         |
|                      | 0.5                         |  | BLA2ABB470SN4     | 47ohm±25%      | -            | 200mA         |     |            |                                      |      | RefFlow |         |         |
|                      | 0.5                         |  | BLA2ABB121SN4     | 120ohm±25%     | -            | 50mA          |     |            |                                      |      | RefFlow |         |         |
| 0.5                  | BLA2ABB221SN4               | 220ohm±25%   | -                 | 50mA           |              |               |     |            | RefFlow                              |      |         |         |         |

Continued on the following page.

△Note • Please read rating and △CAUTION (for storage, operating, rating, soldering, mounting and handling) in this catalog to prevent smoking and/or burning, etc.  
• This catalog has only typical specifications. Therefore, please approve our product specifications or transact the approval sheet for product specifications before ordering.



| Size Code<br>in inch<br>(in mm) | Thickness<br>(mm) | Type                        | Part Number   | Impedance      |              | Rated Current | New | Kit | $\geq 1A$<br>$\geq 3A$<br>$\geq 10A$ | $\geq 1GHz$<br>$\geq 3GHz$<br>$\geq 10GHz$ | Flow                  | R <sub>eff</sub> Flow |
|---------------------------------|-------------------|-----------------------------|---------------|----------------|--------------|---------------|-----|-----|--------------------------------------|--|-----------------------|-----------------------|
|                                 |                   |                             |               | at 100MHz/20°C | at 1GHz/20°C |               |     |     |                                      |  |                       |                       |
| 1206<br>(3216)                  | 0.8               | For General Signal Lines    | BLA31AG300SN4 | 30ohm±25%      | -            | 200mA         |     |     |                                      |  | Flow                  | R <sub>eff</sub> Flow |
|                                 | 0.8               |                             | BLA31AG600SN4 | 60ohm±25%      | -            | 200mA         |     |     |                                      |  | Flow                  | R <sub>eff</sub> Flow |
|                                 | 0.8               |                             | BLA31AG121SN4 | 120ohm±25%     | -            | 150mA         |     |     |                                      |  | Flow                  | R <sub>eff</sub> Flow |
|                                 | 0.8               |                             | BLA31AG221SN4 | 220ohm±25%     | -            | 150mA         |     |     |                                      |  | Flow                  | R <sub>eff</sub> Flow |
|                                 | 0.8               |                             | BLA31AG601SN4 | 600ohm±25%     | -            | 100mA         |     |     |                                      |  | Flow                  | R <sub>eff</sub> Flow |
|                                 | 0.8               |                             | BLA31AG102SN4 | 1000ohm±25%    | -            | 50mA          |     |     |                                      |  | Flow                  | R <sub>eff</sub> Flow |
|                                 | 0.8               | For High Speed Signal Lines | BLA31BD121SN4 | 120ohm±25%     | -            | 150mA         |     |     |                                      |  | Flow                  | R <sub>eff</sub> Flow |
|                                 | 0.8               |                             | BLA31BD221SN4 | 220ohm±25%     | -            | 150mA         |     |     |                                      |  | Flow                  | R <sub>eff</sub> Flow |
|                                 | 0.8               |                             | BLA31BD471SN4 | 470ohm±25%     | -            | 100mA         |     |     |                                      |  | Flow                  | R <sub>eff</sub> Flow |
|                                 | 0.8               |                             | BLA31BD601SN4 | 600ohm±25%     | -            | 100mA         |     |     |                                      |  | Flow                  | R <sub>eff</sub> Flow |
| 0.8                             |                   | BLA31BD102SN4               | 1000ohm±25%   | -              | 50mA         |               |     |     |                                      | Flow                                       | R <sub>eff</sub> Flow |                       |

Chip Ferrite Bead

Chip EMIFIL®

Chip Common Mode Choke Coil

Block Type EMIFIL®

Microwave Absorber

△Note • Please read rating and △CAUTION (for storage, operating, rating, soldering, mounting and handling) in this catalog to prevent smoking and/or burning, etc.  
 • This catalog has only typical specifications. Therefore, please approve our product specifications or transact the approval sheet for product specifications before ordering.

# BLM02AX Series 01005/0402 (inch/mm)



High Spec Ferrite Bead ultra low DC resistance. For general signal lines.

Chip Ferrite Bead  
01005/0402 (inch/mm)

Chip EMIFIL®

Chip Common Mode Choke Coil

Block Type EMIFIL®

Microwave Absorber



### ■ Dimensions

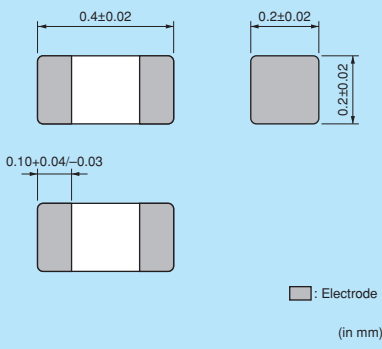

(in mm)

### ■ Equivalent Circuit



(Resistance element becomes dominant at high frequencies.)

### ■ Packaging

| Code | Packaging             | Minimum Quantity |
|------|-----------------------|------------------|
| D    | 180mm Reel Paper Tape | 20000            |
| B    | Bulk(Bag)             | 1000             |

Refer to pages from p.100 to p.103 for mounting information.

### ■ Rated Value (□: packaging code)

| Part Number    | Impedance (at 100MHz/20°C) | Rated Current | DC Resistance | Operating Temperature Range |     |
|----------------|----------------------------|---------------|---------------|-----------------------------|-----|
| BLM02AX100SN1□ | 10ohm ±5 ohm               | 750mA         | 0.07ohm max.  | -55°C to +125°C             | Kit |
| BLM02AX700SN1□ | 70ohm ±25%                 | 300mA         | 0.4ohm max.   | -55°C to +125°C             | Kit |
| BLM02AX121SN1□ | 120ohm ±25%                | 250mA         | 0.5ohm max.   | -55°C to +125°C             | Kit |

Number of Circuits: 1

### ■ Impedance-Frequency Characteristics

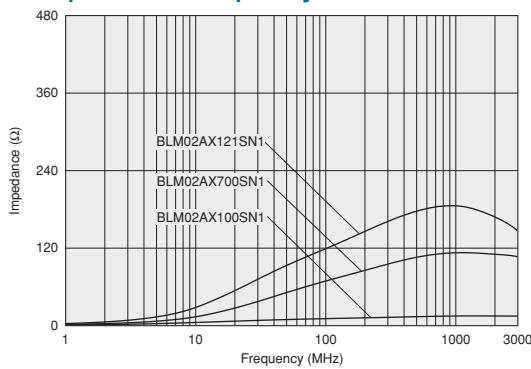

### ■ Impedance-Frequency Characteristics

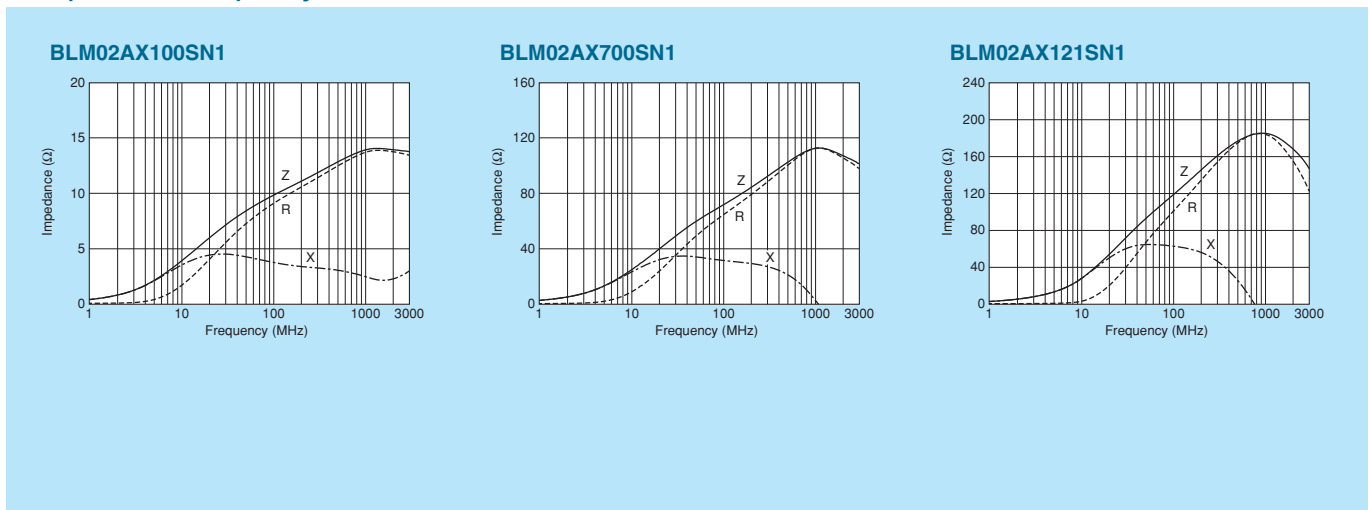

⚠Note • Please read rating and ⚠CAUTION (for storage, operating, rating, soldering, mounting and handling) in this catalog to prevent smoking and/or burning, etc.  
• This catalog has only typical specifications. Therefore, please approve our product specifications or transact the approval sheet for product specifications before ordering.

Excellent for Both Signal and Power Lines.  
Multi Function Chip Ferrite Bead BLM□□AX Series

Feature

- 1/2 the DC resistance than conventional type utilizing the latest technology
  - New ferrite material
  - Optimum ferrite firing condition
  - Fine piling technology
  - Advanced coil pattern design technology
- Improved stability of performance at heat shock
- Wide line-up from 10 to 1000ohm(@100MHz) useful for signal line

Advantage

- High Rated Current
  - Good for miniaturization of high power equipment
- Lower Voltage down at Ferrite bead
  - Good for Battery driven equipment by saving running voltage margin
- Higher Reliability

Drastically Reduced DC Resistance

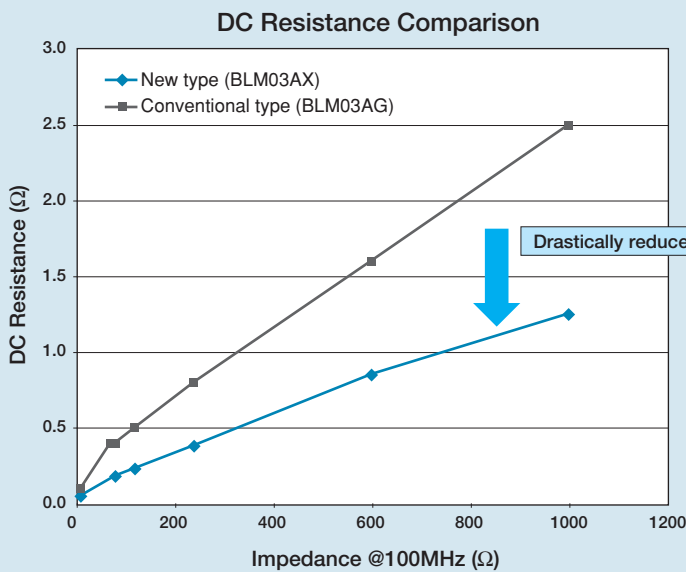

Test Result - Heat Shock

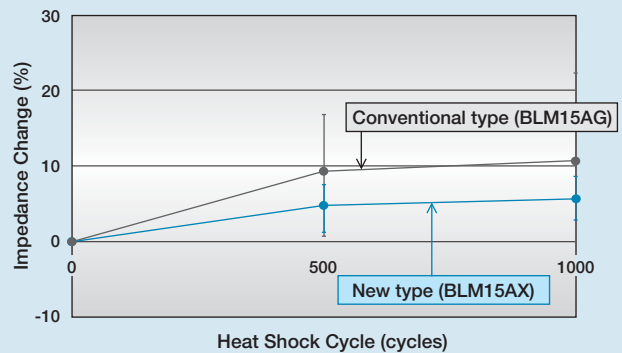

△Note • Please read rating and △CAUTION (for storage, operating, rating, soldering, mounting and handling) in this catalog to prevent smoking and/or burning, etc.  
• This catalog has only typical specifications. Therefore, please approve our product specifications or transact the approval sheet for product specifications before ordering.

# BLM02BX Series 01005/0402 (inch/mm)



High Spec Ferrite Bead ultra low DC resistance. For high speed signal lines.

Chip Ferrite Bead  
01005/0402 (inch/mm)

Chip EMIFIL®

Chip Common Mode Choke Coil

Block Type EMIFIL®

Microwave Absorber



### ■ Dimensions

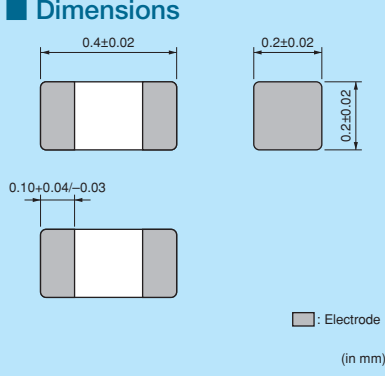

(in mm)

### ■ Equivalent Circuit



(Resistance element becomes dominant at high frequencies.)

### ■ Packaging

| Code | Packaging             | Minimum Quantity |
|------|-----------------------|------------------|
| D    | 180mm Reel Paper Tape | 20000            |
| B    | Bulk(Bag)             | 1000             |

Refer to pages from p.100 to p.103 for mounting information.

### ■ Rated Value (□: packaging code)

| Part Number    | Impedance (at 100MHz/20°C) | Rated Current | DC Resistance | Operating Temperature Range |            |
|----------------|----------------------------|---------------|---------------|-----------------------------|------------|
| BLM02BX151SN1□ | 150ohm ±25%                | 200mA         | 0.7ohm max.   | -55°C to +125°C             | <b>New</b> |

Number of Circuits: 1

### ■ Impedance-Frequency Characteristics

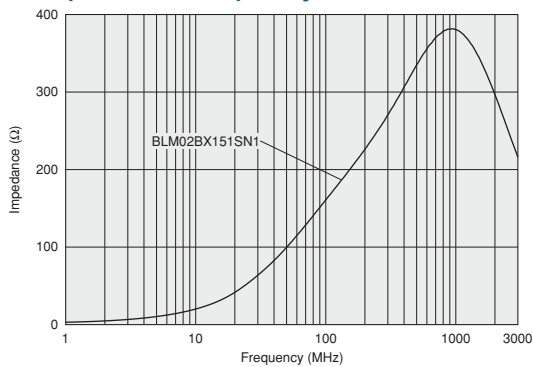

### ■ Impedance-Frequency Characteristics



△Note • Please read rating and △CAUTION (for storage, operating, rating, soldering, mounting and handling) in this catalog to prevent smoking and/or burning, etc.  
• This catalog has only typical specifications. Therefore, please approve our product specifications or transact the approval sheet for product specifications before ordering.

# BLM03PG Series 0201/0603 (inch/mm)



## 0201 size for power lines.

\*Please refer to the products designed for both power lines and signal lines.



### ■ Dimensions

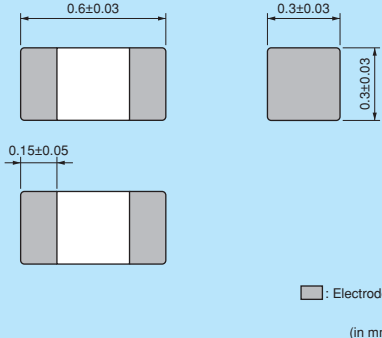

■: Electrode  
(in mm)

### ■ Equivalent Circuit



(Resistance element becomes dominant at high frequencies.)

### ■ Packaging

| Code | Packaging             | Minimum Quantity |
|------|-----------------------|------------------|
| D    | 180mm Reel Paper Tape | 15000            |
| J    | 330mm Reel Paper Tape | 50000            |
| B    | Bulk(Bag)             | 1000             |

Refer to pages from p.100 to p.103 for mounting information.

### ■ Rated Value (□: packaging code)

| Part Number    | Impedance (at 100MHz/20°C) | Rated Current | DC Resistance | Operating Temperature Range |     |
|----------------|----------------------------|---------------|---------------|-----------------------------|-----|
| BLM03PG220SN1□ | 22ohm ±25%                 | 900mA         | 0.065ohm max. | -55°C to +125°C             | Kit |
| BLM03PG330SN1□ | 33ohm ±25%                 | 750mA         | 0.090ohm max. | -55°C to +125°C             | Kit |

Number of Circuits: 1

### ■ Impedance-Frequency Characteristics

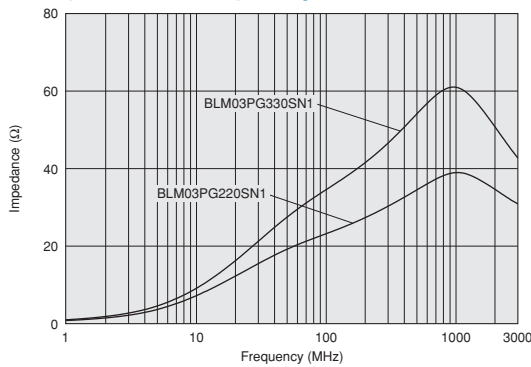

### ■ Impedance-Frequency Characteristics

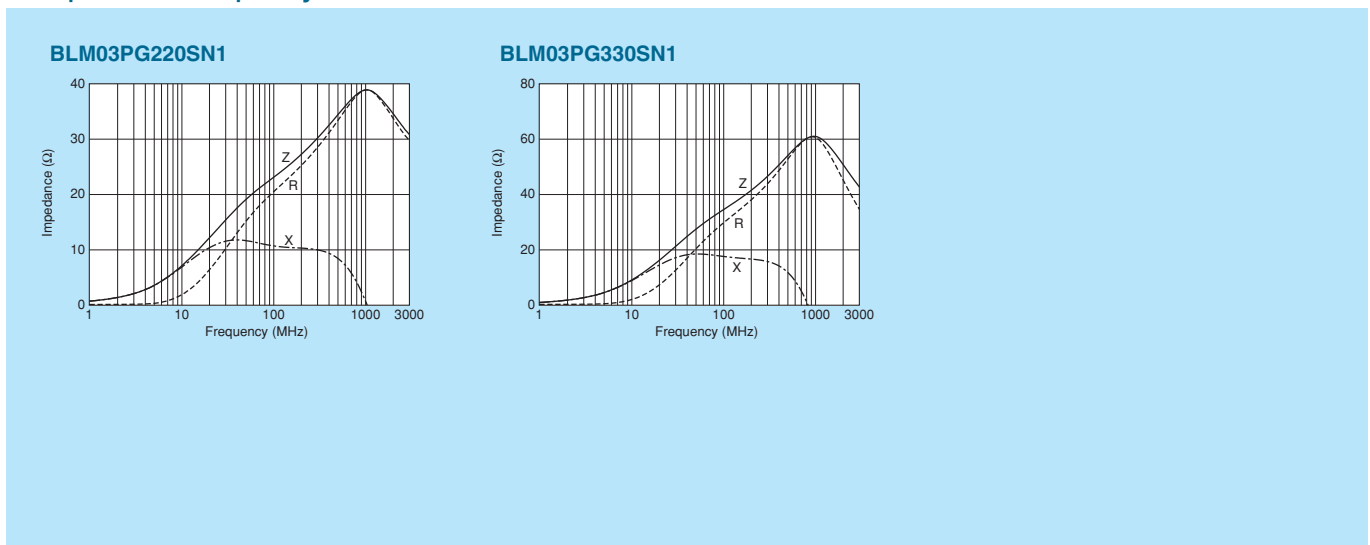

⚠Note • Please read rating and ⚠CAUTION (for storage, operating, rating, soldering, mounting and handling) in this catalog to prevent smoking and/or burning, etc.  
• This catalog has only typical specifications. Therefore, please approve our product specifications or transact the approval sheet for product specifications before ordering.

0201/0603 (inch/mm)  
Chip Ferrite Bead

Chip EMIFIL®

Chip Common Mode Choke Coil

Block Type EMIFIL®

Microwave Absorber

# BLM03PX Series 0201/0603 (inch/mm)



Improved DC resistance meets larger current.

Chip Ferrite Bead 0201/0603 (inch/mm)



### ■ Dimensions

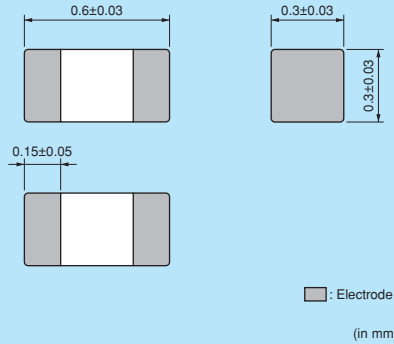

### ■ Equivalent Circuit

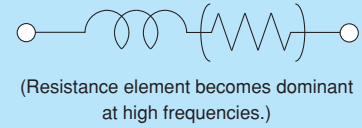

### ■ Packaging

| Code | Packaging             | Minimum Quantity |
|------|-----------------------|------------------|
| D    | 180mm Reel Paper Tape | 15000            |
| J    | 330mm Reel Paper Tape | 50000            |
| B    | Bulk(Bag)             | 1000             |

Refer to pages from p.100 to p.103 for mounting information.

### ■ Rated Value (□: packaging code)

| Part Number     | Impedance (at 100MHz/20°C) | Rated Current | DC Resistance | Operating Temperature Range |         |
|-----------------|----------------------------|---------------|---------------|-----------------------------|---------|
| BLM03PX220SN1 □ | 22ohm ±25%                 | 1800mA        | 0.040ohm max. | -55°C to +125°C             | Kit ≥1A |
| BLM03PX330SN1 □ | 33ohm ±25%                 | 1500mA        | 0.055ohm max. | -55°C to +125°C             | Kit ≥1A |
| BLM03PX800SN1 □ | 80ohm ±25%                 | 1000mA        | 0.130ohm max. | -55°C to +125°C             | Kit ≥1A |

Number of Circuits: 1

Chip EMIFIL®

Chip Common Mode Choke Coil

### ■ Impedance-Frequency Characteristics

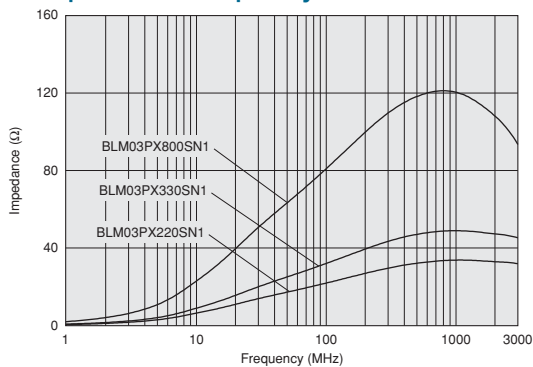

### ■ Notice (Rating)

In operating temperature exceeding +85°C derating of current is necessary for BLM03PX\_SN1 series. Please apply the derating curve shown in chart according to the operating temperature.

Derating of Rated Current

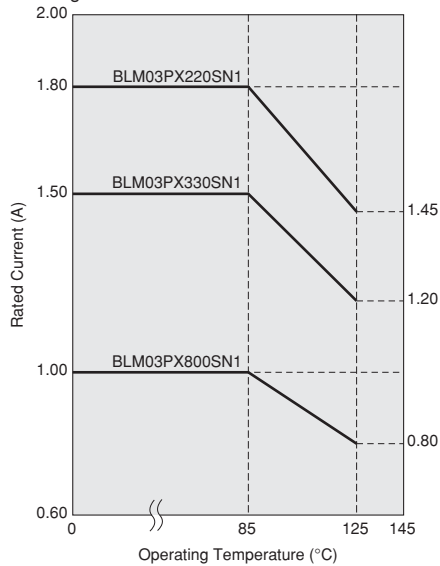

Continued on the following page.

△Note • Please read rating and △CAUTION (for storage, operating, rating, soldering, mounting and handling) in this catalog to prevent smoking and/or burning, etc.  
• This catalog has only typical specifications. Therefore, please approve our product specifications or transact the approval sheet for product specifications before ordering.

Block Type EMIFIL®

Microwave Absorber

■ Impedance-Frequency Characteristics

BLM03PX220SN1

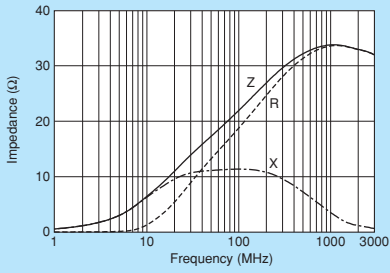

BLM03PX330SN1

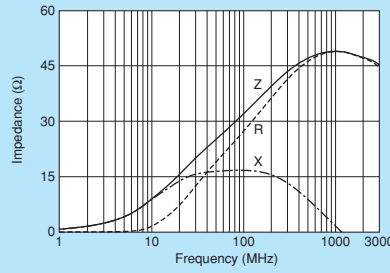

BLM03PX800SN1

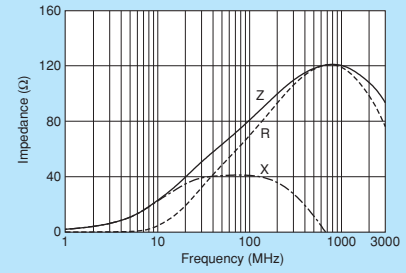

0201/0603 (inch/mm)  
 Chip Ferrite Bead

Chip EMIFIL®

Chip Common Mode Choke Coil

Block Type EMIFIL®

Microwave Absorber

⚠Note • Please read rating and ⚠CAUTION (for storage, operating, rating, soldering, mounting and handling) in this catalog to prevent smoking and/or burning, etc.  
 • This catalog has only typical specifications. Therefore, please approve our product specifications or transact the approval sheet for product specifications before ordering.

# BLM03AX Series 0201/0603 (inch/mm)



High Spec Ferrite Bead Ultra low DC resistance and wide impedance line up. Fit for both power lines and signal lines.

Chip Ferrite Bead 0201/0603 (inch/mm)



### ■ Dimensions

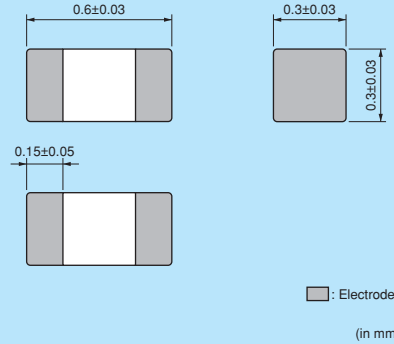

### ■ Equivalent Circuit

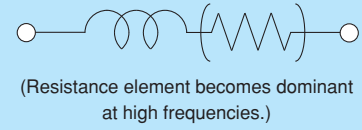

### ■ Packaging

| Code | Packaging             | Minimum Quantity |
|------|-----------------------|------------------|
| D    | 180mm Reel Paper Tape | 15000            |
| J    | 330mm Reel Paper Tape | 50000            |
| B    | Bulk(Bag)             | 1000             |

Refer to pages from p.100 to p.103 for mounting information.

### ■ Rated Value (□: packaging code)

| Part Number    | Impedance (at 100MHz/20°C) | Rated Current | DC Resistance | Operating Temperature Range |               |
|----------------|----------------------------|---------------|---------------|-----------------------------|---------------|
| BLM03AX100SN1□ | 10ohm (Typ.)               | 1000mA        | 0.05ohm max.  | -55°C to +125°C             | Kit $\geq 1A$ |
| BLM03AX800SN1□ | 80ohm $\pm 25\%$           | 500mA         | 0.18ohm max.  | -55°C to +125°C             | Kit           |
| BLM03AX121SN1□ | 120ohm $\pm 25\%$          | 450mA         | 0.23ohm max.  | -55°C to +125°C             | Kit           |
| BLM03AX241SN1□ | 240ohm $\pm 25\%$          | 350mA         | 0.38ohm max.  | -55°C to +125°C             | Kit           |
| BLM03AX601SN1□ | 600ohm $\pm 25\%$          | 250mA         | 0.85ohm max.  | -55°C to +125°C             | Kit           |
| BLM03AX102SN1□ | 1000ohm $\pm 25\%$         | 200mA         | 1.25ohm max.  | -55°C to +125°C             | Kit           |

Number of Circuits: 1

### ■ Impedance-Frequency Characteristics

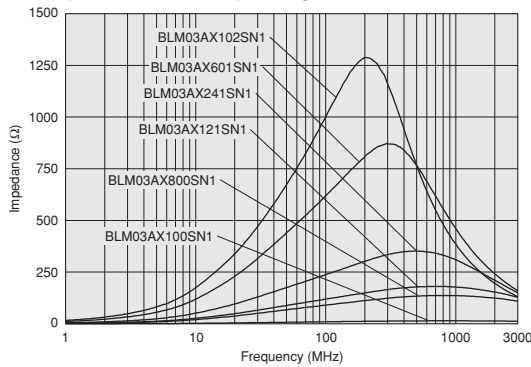

### ■ Impedance-Frequency Characteristics

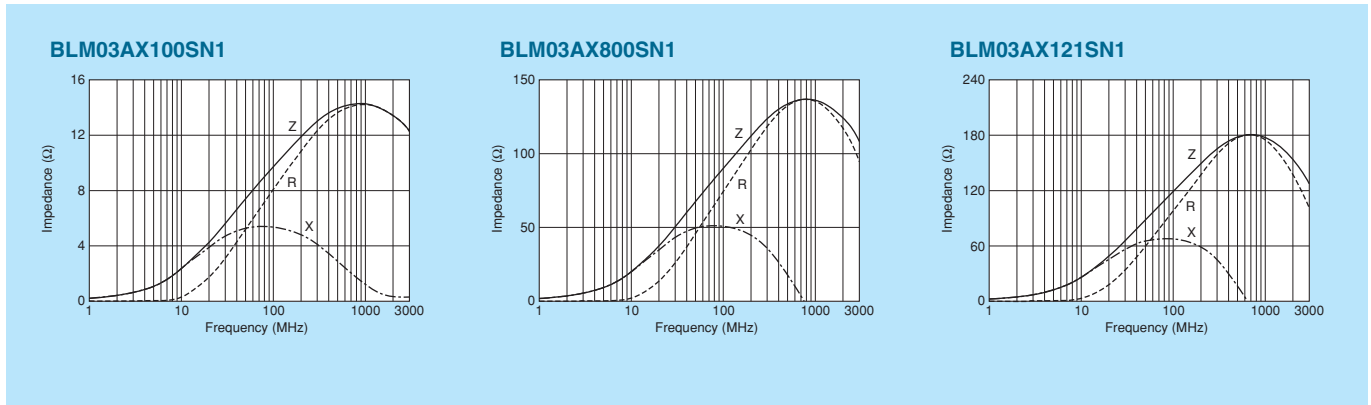

Continued on the following page.

⚠ Note • Please read rating and ⚠ CAUTION (for storage, operating, rating, soldering, mounting and handling) in this catalog to prevent smoking and/or burning, etc.  
• This catalog has only typical specifications. Therefore, please approve our product specifications or transact the approval sheet for product specifications before ordering.

Chip EMIFIL®

Chip Common Mode Choke Coil

Block Type EMIFIL®

Microwave Absorber



Impedance-Frequency Characteristics

BLM03AX241SN1

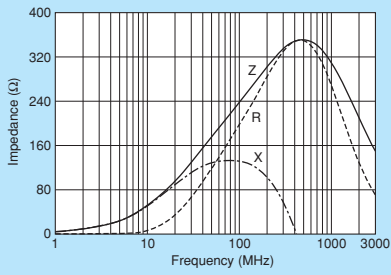

BLM03AX601SN1

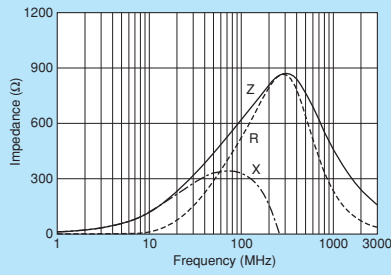

BLM03AX102SN1

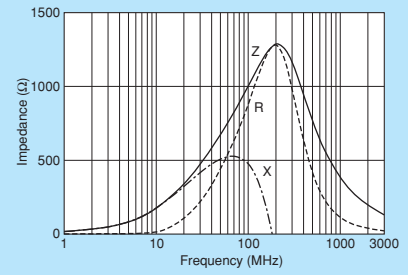

0201/0603 (inch/mm)  
Chip Ferrite Bead

Chip EMIFIL®

Chip Common Mode Choke Coil

Block Type EMIFIL®

Microwave Absorber

⚠Note • Please read rating and ⚠CAUTION (for storage, operating, rating, soldering, mounting and handling) in this catalog to prevent smoking and/or burning, etc.  
 • This catalog has only typical specifications. Therefore, please approve our product specifications or transact the approval sheet for product specifications before ordering.

# BLM03AG Series 0201/0603 (inch/mm)



0201 size for general signal lines.

Chip Ferrite Bead  
0201/0603 (inch/mm)

Chip EMIFIL®

Chip Common Mode Choke Coil

Block Type EMIFIL®

Microwave Absorber



### Dimensions

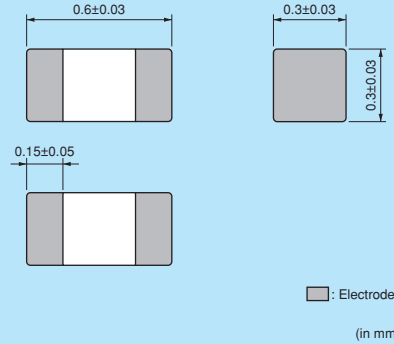

### Equivalent Circuit

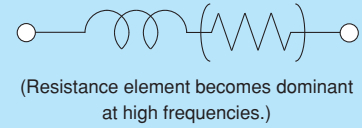

### Packaging

| Code | Packaging             | Minimum Quantity |
|------|-----------------------|------------------|
| D    | 180mm Reel Paper Tape | 15000            |
| J    | 330mm Reel Paper Tape | 50000            |
| B    | Bulk(Bag)             | 1000             |

Refer to pages from p.100 to p.103 for mounting information.

### Rated Value (□: packaging code)

| Part Number    | Impedance (at 100MHz/20°C) | Rated Current | DC Resistance | Operating Temperature Range |     |
|----------------|----------------------------|---------------|---------------|-----------------------------|-----|
| BLM03AG100SN1□ | 10ohm (Typ.)               | 500mA         | 0.1ohm max.   | -55°C to +125°C             | Kit |
| BLM03AG700SN1□ | 70ohm (Typ.)               | 200mA         | 0.4ohm max.   | -55°C to +125°C             | Kit |
| BLM03AG800SN1□ | 80ohm ±25%                 | 200mA         | 0.4ohm max.   | -55°C to +125°C             | Kit |
| BLM03AG121SN1□ | 120ohm ±25%                | 200mA         | 0.5ohm max.   | -55°C to +125°C             | Kit |
| BLM03AG241SN1□ | 240ohm ±25%                | 200mA         | 0.8ohm max.   | -55°C to +125°C             | Kit |
| BLM03AG601SN1□ | 600ohm ±25%                | 100mA         | 1.5ohm max.   | -55°C to +125°C             | Kit |
| BLM03AG102SN1□ | 1000ohm ±25%               | 100mA         | 2.5ohm max.   | -55°C to +125°C             | Kit |

Number of Circuits: 1

### Impedance-Frequency Characteristics

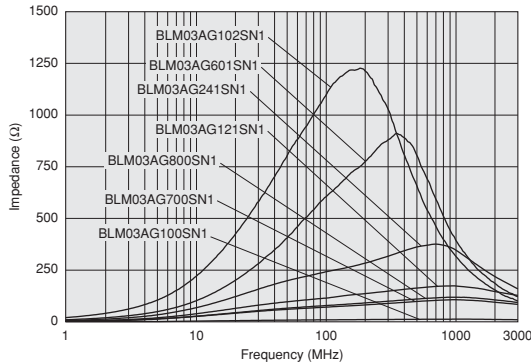

### Impedance-Frequency Characteristics

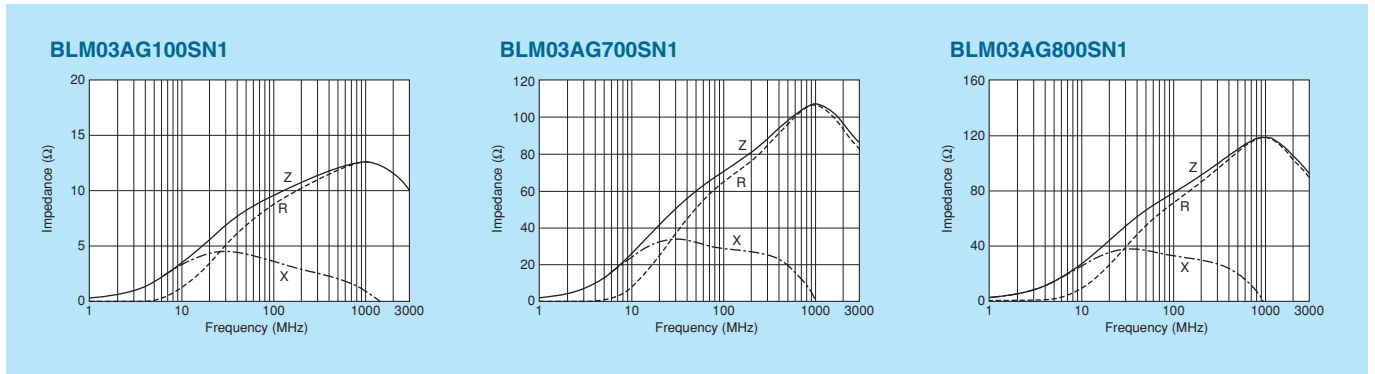

Continued on the following page.

⚠Note • Please read rating and ⚠CAUTION (for storage, operating, rating, soldering, mounting and handling) in this catalog to prevent smoking and/or burning, etc.  
• This catalog has only typical specifications. Therefore, please approve our product specifications or transact the approval sheet for product specifications before ordering.

Impedance-Frequency Characteristics

BLM03AG121SN1

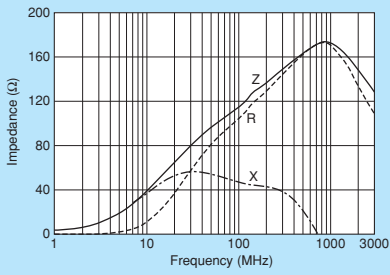

BLM03AG241SN1

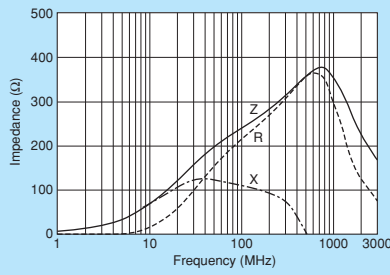

BLM03AG601SN1

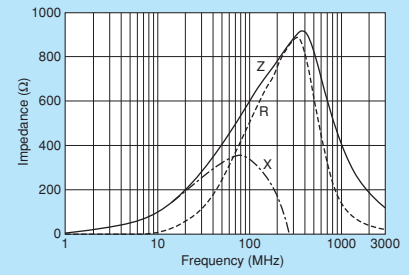

BLM03AG102SN1

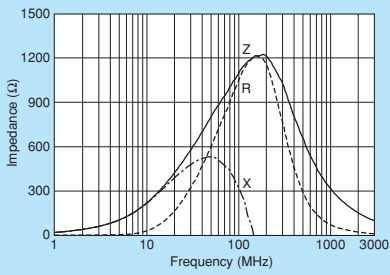

0201/0603 (inch/mm)  
 Chip Ferrite Bead

Chip EMIFIL®

Chip Common Mode Choke Coil

Block Type EMIFIL®

Microwave Absorber

⚠Note • Please read rating and ⚠CAUTION (for storage, operating, rating, soldering, mounting and handling) in this catalog to prevent smoking and/or burning, etc.  
 • This catalog has only typical specifications. Therefore, please approve our product specifications or transact the approval sheet for product specifications before ordering.

# BLM03B Series 0201/0603 (inch/mm)



0201 size for high speed signal lines.

Chip Ferrite Bead  
0201/0603 (inch/mm)

Chip EMIFIL®

Chip Common Mode Choke Coil

Block Type EMIFIL®

Microwave Absorber

### ■ Dimensions

(in mm)

### ■ Equivalent Circuit

(Resistance element becomes dominant at high frequencies.)

### ■ Packaging

| Code | Packaging             | Minimum Quantity |
|------|-----------------------|------------------|
| D    | 180mm Reel Paper Tape | 15000            |
| J    | 330mm Reel Paper Tape | 50000            |
| B    | Bulk(Bag)             | 1000             |

Refer to pages from p.100 to p.103 for mounting information.

## ■ Rated Value (□: packaging code)

| Part Number    | Impedance (at 100MHz/20°C) | Rated Current | DC Resistance | Operating Temperature Range |     |
|----------------|----------------------------|---------------|---------------|-----------------------------|-----|
| BLM03BD750SN1□ | 75ohm ±25%                 | 300mA         | 0.4ohm max.   | -55°C to +125°C             | Kit |
| BLM03BD121SN1□ | 120ohm ±25%                | 250mA         | 0.5ohm max.   | -55°C to +125°C             | Kit |
| BLM03BD241SN1□ | 240ohm ±25%                | 200mA         | 0.8ohm max.   | -55°C to +125°C             | Kit |
| BLM03BD471SN1□ | 470ohm ±25%                | 215mA         | 1.5ohm max.   | -55°C to +125°C             | Kit |
| BLM03BD601SN1□ | 600ohm ±25%                | 200mA         | 1.7ohm max.   | -55°C to +125°C             | Kit |
| BLM03BB100SN1□ | 10ohm ±25%                 | 300mA         | 0.4ohm max.   | -55°C to +125°C             | Kit |
| BLM03BB220SN1□ | 22ohm ±25%                 | 200mA         | 0.5ohm max.   | -55°C to +125°C             | Kit |
| BLM03BB470SN1□ | 47ohm ±25%                 | 200mA         | 0.7ohm max.   | -55°C to +125°C             | Kit |
| BLM03BB750SN1□ | 75ohm ±25%                 | 200mA         | 1.0ohm max.   | -55°C to +125°C             | Kit |
| BLM03BB121SN1□ | 120ohm ±25%                | 100mA         | 1.5ohm max.   | -55°C to +125°C             | Kit |
| BLM03BC330SN1□ | 33ohm ±25%                 | 150mA         | 0.85ohm max.  | -55°C to +125°C             | Kit |
| BLM03BC560SN1□ | 56ohm ±25%                 | 100mA         | 1.05ohm max.  | -55°C to +125°C             | Kit |
| BLM03BC800SN1□ | 80ohm ±25%                 | 100mA         | 1.40ohm max.  | -55°C to +125°C             | Kit |

Number of Circuits: 1

## ■ Impedance-Frequency Characteristics

### BLM03BD Series

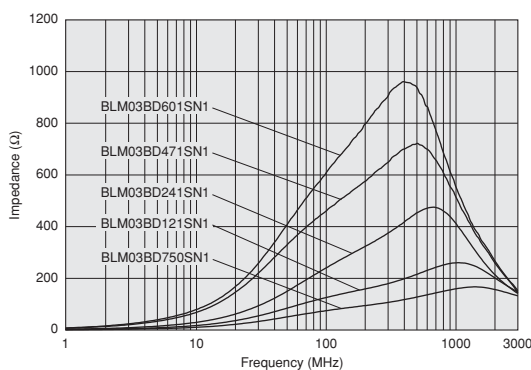

### BLM03BB Series

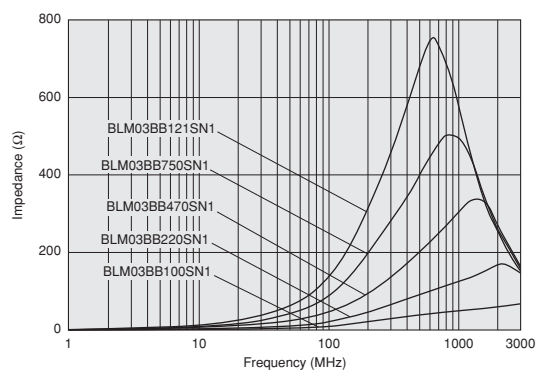

Continued on the following page. ↗

△Note • Please read rating and △CAUTION (for storage, operating, rating, soldering, mounting and handling) in this catalog to prevent smoking and/or burning, etc.  
• This catalog has only typical specifications. Therefore, please approve our product specifications or transact the approval sheet for product specifications before ordering.

Impedance-Frequency Characteristics  
 BLM03BC Series

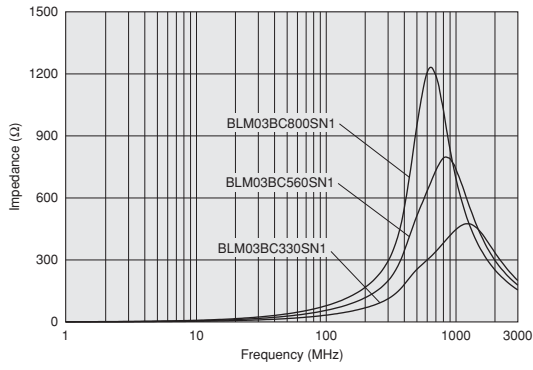

Impedance-Frequency Characteristics

BLM03BD750SN1

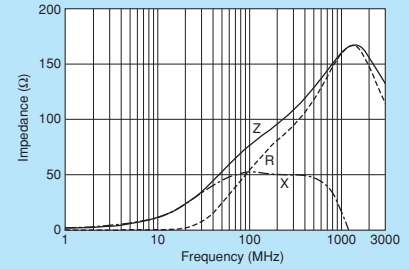

BLM03BD121SN1

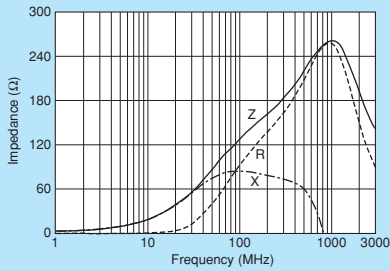

BLM03BD241SN1

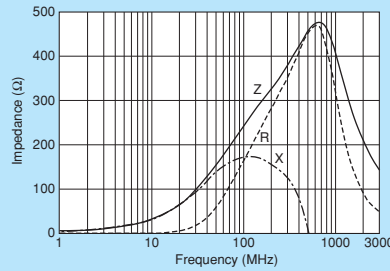

BLM03BD471SN1

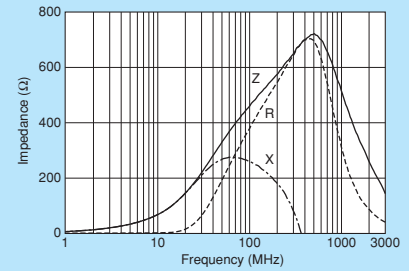

BLM03BD601SN1

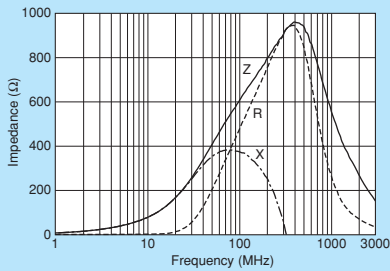

BLM03BB100SN1

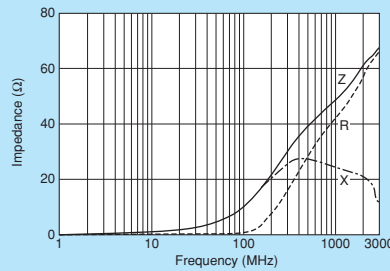

BLM03BB220SN1

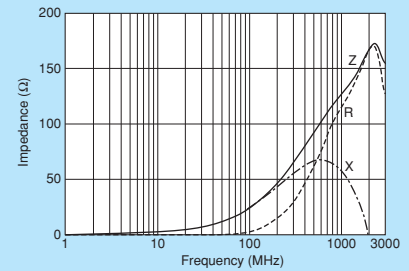

BLM03BB470SN1

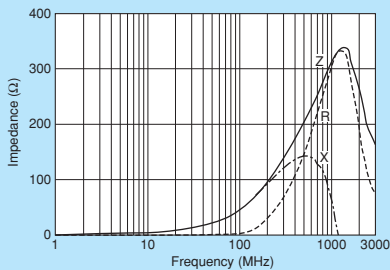

BLM03BB750SN1

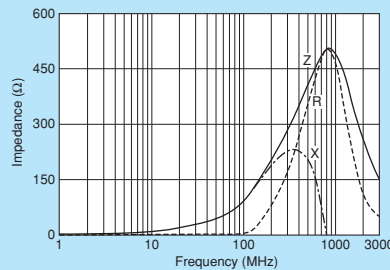

BLM03BB121SN1

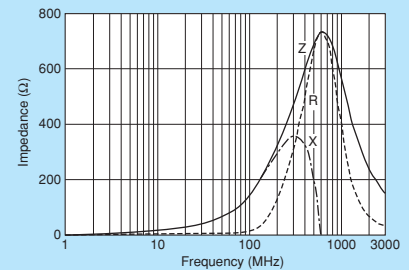

BLM03BC330SN1

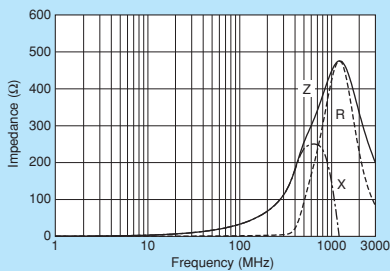

BLM03BC560SN1

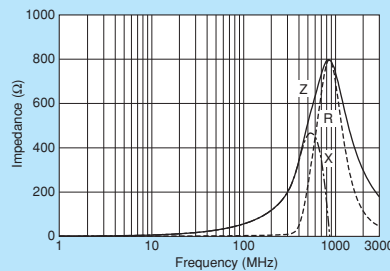

BLM03BC800SN1

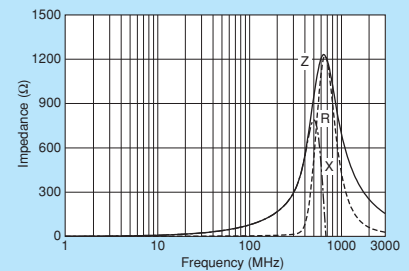

0201/0603 (inch/mm)  
 Chip Ferrite Bead

Chip EMIFIL®

Chip Common Mode Choke Coil

Block Type EMIFIL®

Microwave Absorber

△Note • Please read rating and △CAUTION (for storage, operating, rating, soldering, mounting and handling) in this catalog to prevent smoking and/or burning, etc.  
 • This catalog has only typical specifications. Therefore, please approve our product specifications or transact the approval sheet for product specifications before ordering.

# BLM15PX Series 0402/1005 (inch/mm)



3A max., high performance type for power lines up to 600ohm.

Chip Ferrite Bead  
0402/1005 (inch/mm)

Chip EMIFIL®

Chip Common Mode Choke Coil

Block Type EMIFIL®

Microwave Absorber



### ■ Dimensions

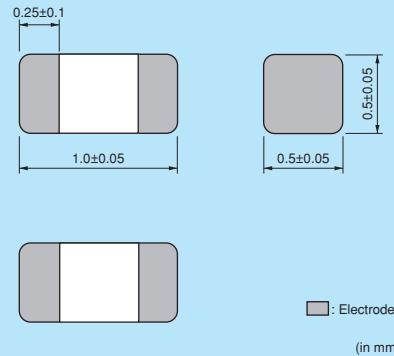

### ■ Equivalent Circuit

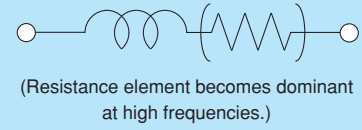

### ■ Packaging

| Code | Packaging             | Minimum Quantity |
|------|-----------------------|------------------|
| D    | 180mm Reel Paper Tape | 10000            |
| J    | 330mm Reel Paper Tape | 50000            |
| B    | Bulk(Bag)             | 1000             |

Refer to pages from p.100 to p.103 for mounting information.

### ■ Rated Value (□: packaging code)

| Part Number    | Impedance (at 100MHz/20°C) | Rated Current | DC Resistance | Operating Temperature Range | Kit | Current |
|----------------|----------------------------|---------------|---------------|-----------------------------|-----|---------|
| BLM15PX330SN1□ | 33ohm ±25%                 | 3000mA        | 0.022ohm max. | -55°C to +125°C             | Kit | ≥3A     |
| BLM15PX600SN1□ | 60ohm ±25%                 | 2500mA        | 0.032ohm max. | -55°C to +125°C             | Kit | ≥1A     |
| BLM15PX800SN1□ | 80ohm ±25%                 | 2300mA        | 0.038ohm max. | -55°C to +125°C             | Kit | ≥1A     |
| BLM15PX121SN1□ | 120ohm ±25%                | 2000mA        | 0.055ohm max. | -55°C to +125°C             | Kit | ≥1A     |
| BLM15PX181SN1□ | 180ohm ±25%                | 1500mA        | 0.090ohm max. | -55°C to +125°C             | Kit | ≥1A     |
| BLM15PX221SN1□ | 220ohm ±25%                | 1400mA        | 0.10ohm max.  | -55°C to +125°C             | Kit | ≥1A     |
| BLM15PX331SN1□ | 330ohm ±25%                | 1200mA        | 0.15ohm max.  | -55°C to +125°C             | Kit | ≥1A     |
| BLM15PX471SN1□ | 470ohm ±25%                | 1000mA        | 0.20ohm max.  | -55°C to +125°C             | Kit | ≥1A     |
| BLM15PX601SN1□ | 600ohm ±25%                | 900mA         | 0.23ohm max.  | -55°C to +125°C             | Kit |         |

Number of Circuits: 1

### ■ Impedance-Frequency Characteristics

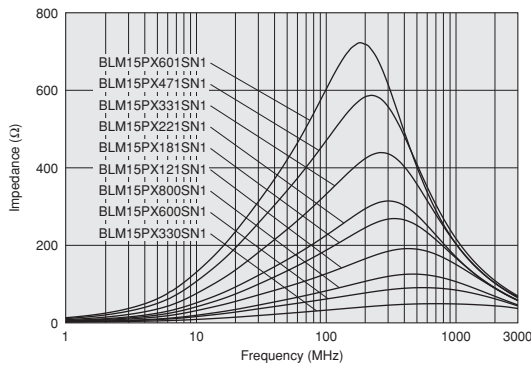

### ■ Notice (Rating)

In operating temperature exceeding +85°C, derating of current is necessary for BLM15PX series.

Please apply the derating curve shown in chart according to the operating temperature.

Derating of Rated Current

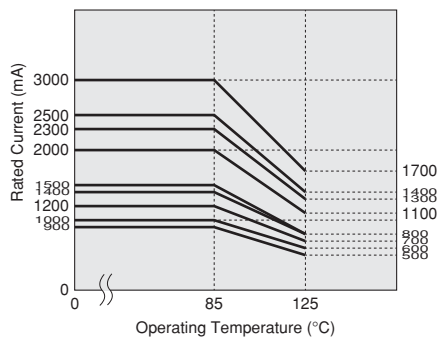

Continued on the following page. ↗

△Note • Please read rating and △CAUTION (for storage, operating, rating, soldering, mounting and handling) in this catalog to prevent smoking and/or burning, etc.  
 • This catalog has only typical specifications. Therefore, please approve our product specifications or transact the approval sheet for product specifications before ordering.

Impedance-Frequency Characteristics

BLM15PX330SN1

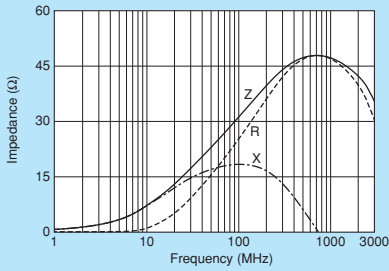

BLM15PX600SN1

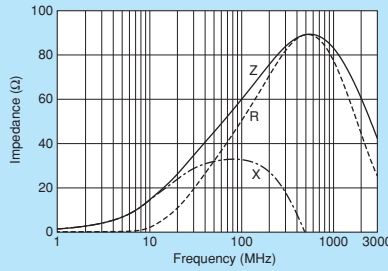

BLM15PX800SN1

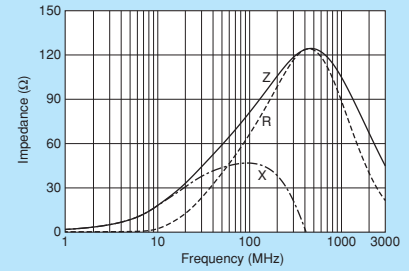

BLM15PX121SN1

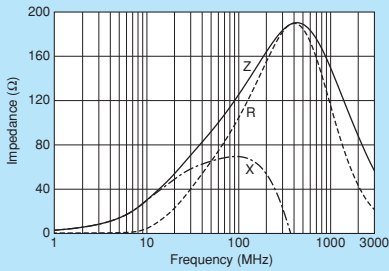

BLM15PX181SN1

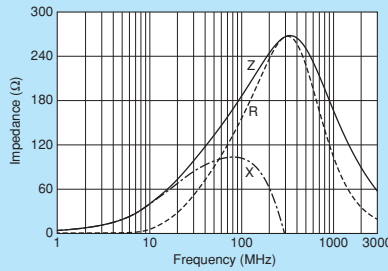

BLM15PX221SN1

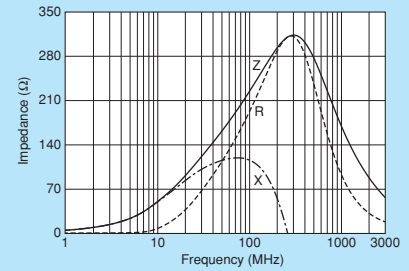

BLM15PX331SN1

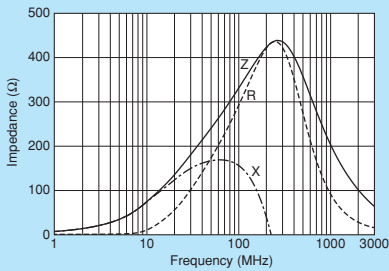

BLM15PX471SN1

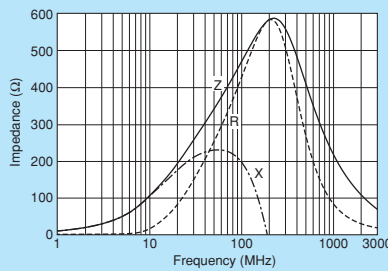

BLM15PX601SN1

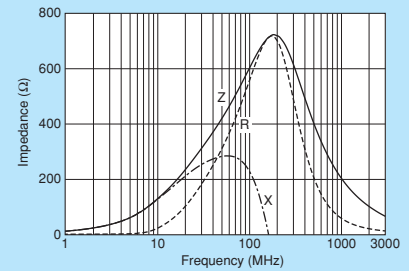

0402/1005 (inch/mm)  
 Chip Ferrite Bead

Chip EMIFIL®

Chip Common Mode Choke Coil

Block Type EMIFIL®

Microwave Absorber

⚠Note • Please read rating and ⚠CAUTION (for storage, operating, rating, soldering, mounting and handling) in this catalog to prevent smoking and/or burning, etc.  
 • This catalog has only typical specifications. Therefore, please approve our product specifications or transact the approval sheet for product specifications before ordering.

# BLM15PG/BLM15PD Series 0402/1005 (inch/mm)



## 0402 size for power lines.

\*Please refer to the products which are designed for both power lines and signal lines.

Chip Ferrite Bead 0402/1005 (inch/mm)



### ■ Dimensions

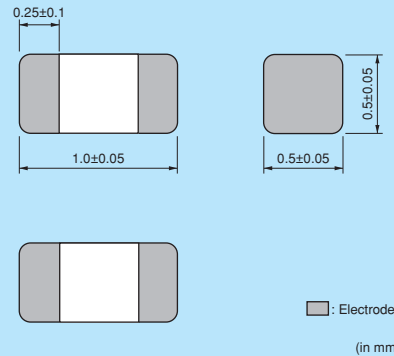

### ■ Equivalent Circuit

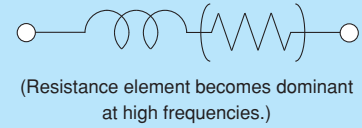

### ■ Packaging

| Code | Packaging             | Minimum Quantity |
|------|-----------------------|------------------|
| D    | 180mm Reel Paper Tape | 10000            |
| J    | 330mm Reel Paper Tape | 50000            |
| B    | Bulk(Bag)             | 1000             |

Refer to pages from p.100 to p.103 for mounting information.

### ■ Rated Value (□: packaging code)

| Part Number    | Impedance (at 100MHz/20°C) | Rated Current | DC Resistance | Operating Temperature Range |         |
|----------------|----------------------------|---------------|---------------|-----------------------------|---------|
| BLM15PG100SN1□ | 10ohm (Typ.)               | 1000mA        | 0.025ohm max. | -55°C to +125°C             | Kit ≥1A |
| BLM15PD300SN1□ | 30ohm ±25%                 | 2200mA        | 0.035ohm max. | -55°C to +125°C             | Kit ≥1A |
| BLM15PD600SN1□ | 60ohm ±25%                 | 1700mA        | 0.06ohm max.  | -55°C to +125°C             | Kit ≥1A |
| BLM15PD800SN1□ | 80ohm ±25%                 | 1500mA        | 0.07ohm max.  | -55°C to +125°C             | Kit ≥1A |
| BLM15PD121SN1□ | 120ohm ±25%                | 1300mA        | 0.09ohm max.  | -55°C to +125°C             | Kit ≥1A |

Number of Circuits: 1

Chip EMIFIL®

Chip Common Mode Choke Coil

Block Type EMIFIL®

Microwave Absorber

### ■ Impedance-Frequency Characteristics

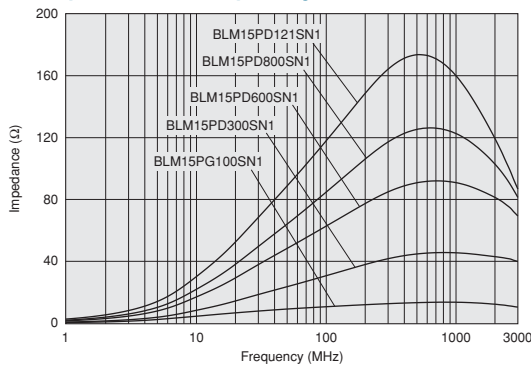

### ■ Notice (Rating)

In operating temperature exceeding +85°C, derating of current is necessary for BLM15PD series.

Please apply the derating curve shown in chart according to the operating temperature.

#### Derating of Rated Current

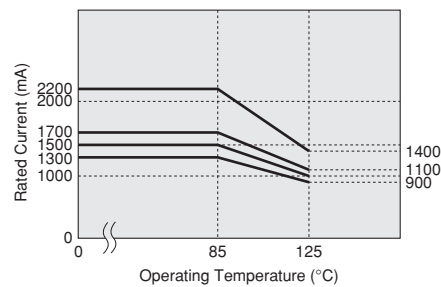

Continued on the following page.

⚠Note • Please read rating and ⚠CAUTION (for storage, operating, rating, soldering, mounting and handling) in this catalog to prevent smoking and/or burning, etc.  
• This catalog has only typical specifications. Therefore, please approve our product specifications or transact the approval sheet for product specifications before ordering.



Impedance-Frequency Characteristics

BLM15PG100SN1

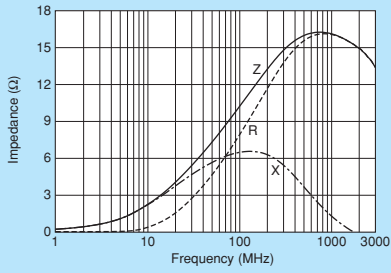

BLM15PD300SN1

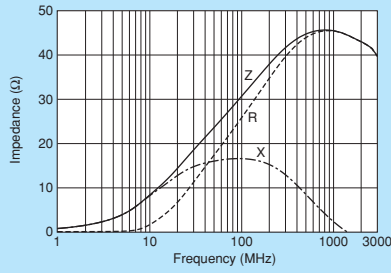

BLM15PD600SN1

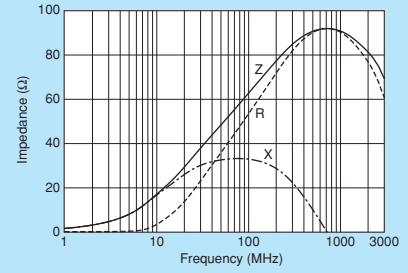

BLM15PD800SN1

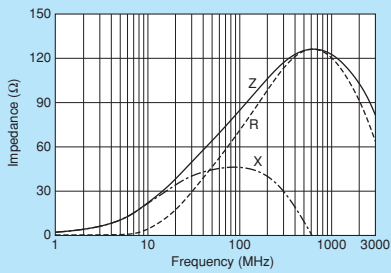

BLM15PD121SN1

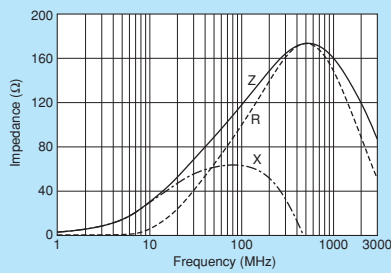

0402/1005 (inch/mm)  
 Chip Ferrite Bead

Chip EMIFIL®

Chip Common Mode Choke Coil

Block Type EMIFIL®

Microwave Absorber

⚠Note • Please read rating and ⚠CAUTION (for storage, operating, rating, soldering, mounting and handling) in this catalog to prevent smoking and/or burning, etc.  
 • This catalog has only typical specifications. Therefore, please approve our product specifications or transact the approval sheet for product specifications before ordering.

# BLM15AX Series 0402/1005 (inch/mm)



High Spec Ferrite Bead Ultra low DC resistance and wide impedance line up. Fit for both power lines and signal lines.

Chip Ferrite Bead  
0402/1005 (inch/mm)

Chip EMIFIL®

Chip Common Mode Choke Coil

Block Type EMIFIL®

Microwave Absorber

### ■ Dimensions

Legend:  Electrode (in mm)

### ■ Equivalent Circuit

(Resistance element becomes dominant at high frequencies.)

### ■ Packaging

| Code | Packaging             | Minimum Quantity |
|------|-----------------------|------------------|
| D    | 180mm Reel Paper Tape | 10000            |
| J    | 330mm Reel Paper Tape | 50000            |
| B    | Bulk(Bag)             | 1000             |

Refer to pages from p.100 to p.103 for mounting information.

### ■ Rated Value (□: packaging code)

| Part Number    | Impedance (at 100MHz/20°C) | Rated Current | DC Resistance | Operating Temperature Range |         |
|----------------|----------------------------|---------------|---------------|-----------------------------|---------|
| BLM15AX100SN1□ | 10ohm ±5ohm                | 1740mA        | 0.015ohm max. | -55°C to +125°C             | Kit ≥1A |
| BLM15AX300SN1□ | 30ohm ±25%                 | 1100mA        | 0.06ohm max.  | -55°C to +125°C             | Kit ≥1A |
| BLM15AX700SN1□ | 70ohm ±25%                 | 780mA         | 0.1ohm max.   | -55°C to +125°C             | Kit     |
| BLM15AX121SN1□ | 120ohm ±25%                | 700mA         | 0.13ohm max.  | -55°C to +125°C             | Kit     |
| BLM15AX221SN1□ | 220ohm ±25%                | 600mA         | 0.18ohm max.  | -55°C to +125°C             | Kit     |
| BLM15AX601SN1□ | 600ohm ±25%                | 500mA         | 0.34ohm max.  | -55°C to +125°C             | Kit     |
| BLM15AX102SN1□ | 1000ohm ±25%               | 350mA         | 0.49ohm max.  | -55°C to +125°C             | Kit     |

Number of Circuits: 1

### ■ Impedance-Frequency Characteristics

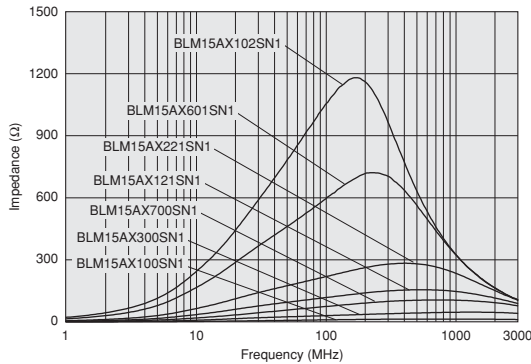

Continued on the following page. ↗

⚠Note • Please read rating and ⚠CAUTION (for storage, operating, rating, soldering, mounting and handling) in this catalog to prevent smoking and/or burning, etc.  
• This catalog has only typical specifications. Therefore, please approve our product specifications or transact the approval sheet for product specifications before ordering.

Impedance-Frequency Characteristics

BLM15AX100SN1

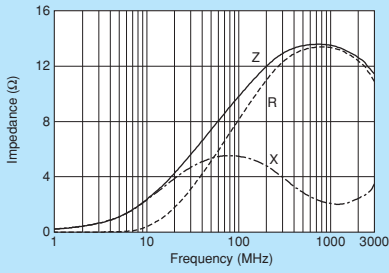

BLM15AX300SN1

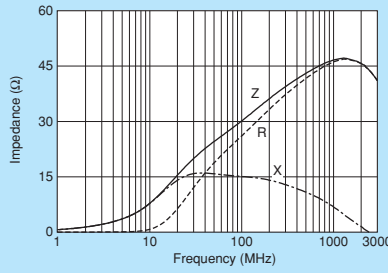

BLM15AX700SN1

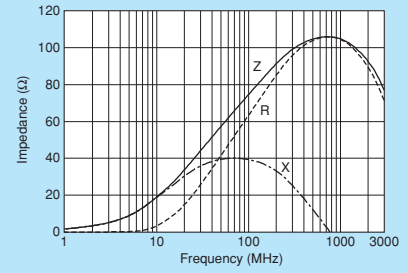

BLM15AX121SN1

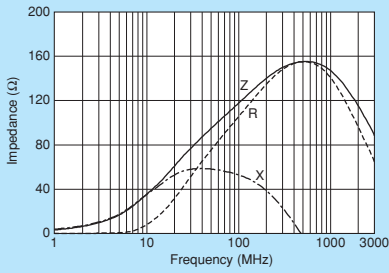

BLM15AX221SN1

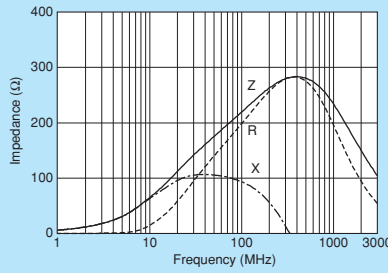

BLM15AX601SN1

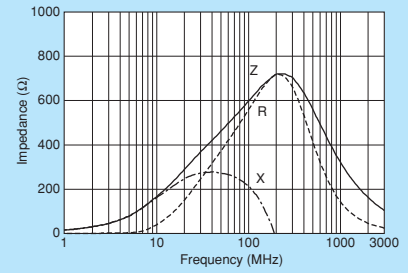

BLM15AX102SN1

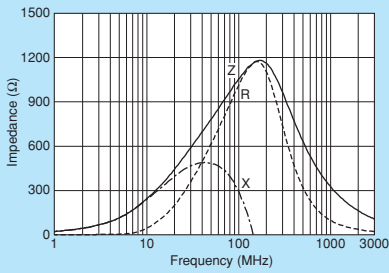

0402/1005 (inch/mm)  
Chip Ferrite Bead

Chip EMIFIL®

Chip Common Mode Choke Coil

Block Type EMIFIL®

Microwave Absorber

⚠Note • Please read rating and ⚠CAUTION (for storage, operating, rating, soldering, mounting and handling) in this catalog to prevent smoking and/or burning, etc.  
 • This catalog has only typical specifications. Therefore, please approve our product specifications or transact the approval sheet for product specifications before ordering.

# BLM15AG Series 0402/1005 (inch/mm)



0402 size for general signal lines.

Chip Ferrite Bead  
0402/1005 (inch/mm)

Chip EMIFIL®

Chip Common Mode Choke Coil

Block Type EMIFIL®

Microwave Absorber



### Dimensions

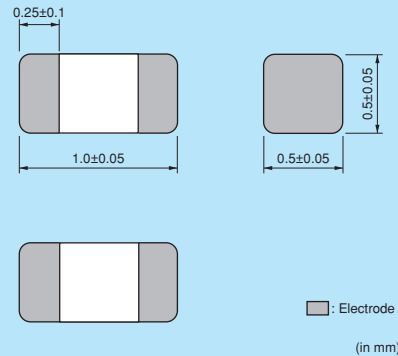

### Equivalent Circuit

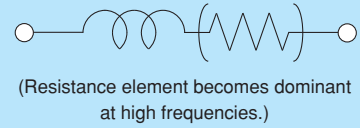

### Packaging

| Code | Packaging             | Minimum Quantity |
|------|-----------------------|------------------|
| D    | 180mm Reel Paper Tape | 10000            |
| J    | 330mm Reel Paper Tape | 50000            |
| B    | Bulk(Bag)             | 1000             |

Refer to pages from p.100 to p.103 for mounting information.

### Rated Value (□: packaging code)

| Part Number    | Impedance (at 100MHz/20°C) | Rated Current | DC Resistance | Operating Temperature Range |               |
|----------------|----------------------------|---------------|---------------|-----------------------------|---------------|
| BLM15AG100SN1□ | 10ohm (Typ.)               | 1000mA        | 0.025ohm max. | -55°C to +125°C             | Kit $\geq 1A$ |
| BLM15AG700SN1□ | 70ohm (Typ.)               | 600mA         | 0.15ohm max.  | -55°C to +125°C             | Kit           |
| BLM15AG121SN1□ | 120ohm $\pm 25\%$          | 550mA         | 0.19ohm max.  | -55°C to +125°C             | Kit           |
| BLM15AG221SN1□ | 220ohm $\pm 25\%$          | 450mA         | 0.29ohm max.  | -55°C to +125°C             | Kit           |
| BLM15AG601SN1□ | 600ohm $\pm 25\%$          | 300mA         | 0.52ohm max.  | -55°C to +125°C             | Kit           |
| BLM15AG102SN1□ | 1000ohm $\pm 25\%$         | 300mA         | 0.65ohm max.  | -55°C to +125°C             | Kit           |

Number of Circuits: 1

### Impedance-Frequency Characteristics

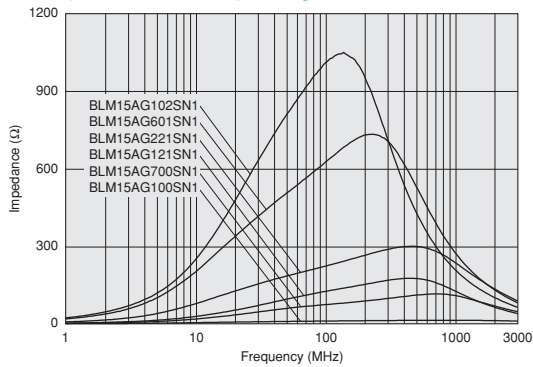

### Impedance-Frequency Characteristics

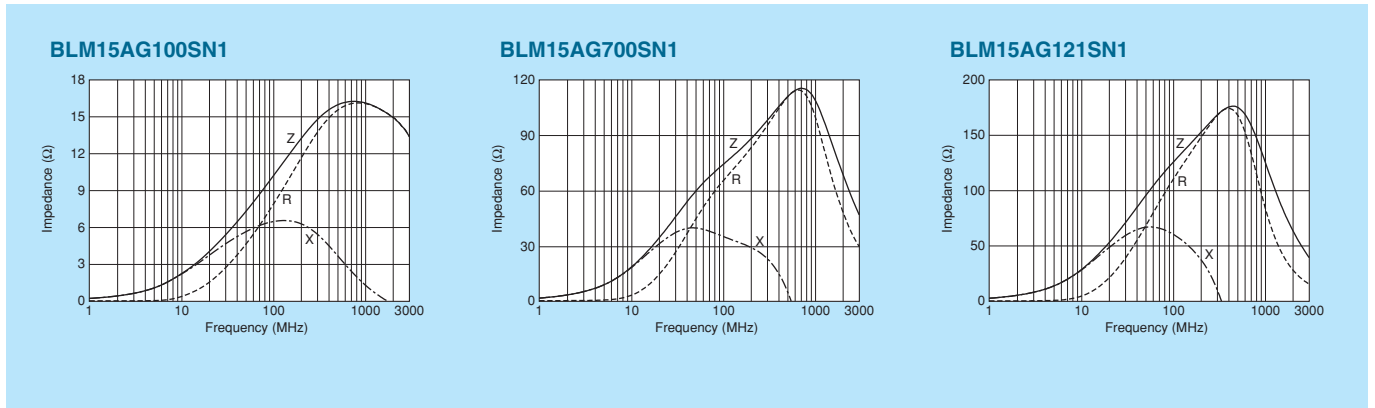

Continued on the following page.

△Note • Please read rating and △CAUTION (for storage, operating, rating, soldering, mounting and handling) in this catalog to prevent smoking and/or burning, etc.  
• This catalog has only typical specifications. Therefore, please approve our product specifications or transact the approval sheet for product specifications before ordering.

Impedance-Frequency Characteristics

BLM15AG221SN1

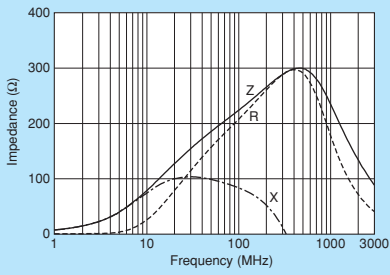

BLM15AG601SN1

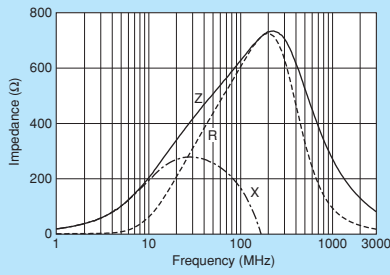

BLM15AG102SN1

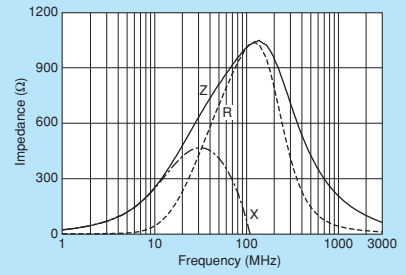

0402/1005 (inch/mm)  
Chip Ferrite Bead

Chip EMIFIL®

Chip Common Mode Choke Coil

Block Type EMIFIL®

Microwave Absorber

⚠Note • Please read rating and ⚠CAUTION (for storage, operating, rating, soldering, mounting and handling) in this catalog to prevent smoking and/or burning, etc.  
 • This catalog has only typical specifications. Therefore, please approve our product specifications or transact the approval sheet for product specifications before ordering.

# BLM15BX Series 0402/1005 (inch/mm)



0402 size for high speed signal lines, low DC resistance.

Chip Ferrite Bead  
0402/1005 (inch/mm)



### ■ Dimensions

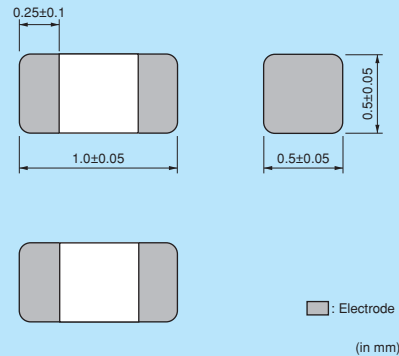

### ■ Equivalent Circuit

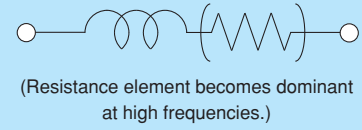

### ■ Packaging

| Code | Packaging             | Minimum Quantity |
|------|-----------------------|------------------|
| D    | 180mm Reel Paper Tape | 10000            |
| J    | 330mm Reel Paper Tape | 50000            |
| B    | Bulk(Bag)             | 1000             |

Refer to pages from p.100 to p.103 for mounting information.

### ■ Rated Value (□: packaging code)

| Part Number    | Impedance (at 100MHz/20°C) | Rated Current | DC Resistance | Operating Temperature Range |     |
|----------------|----------------------------|---------------|---------------|-----------------------------|-----|
| BLM15BX750SN1□ | 75ohm ±25%                 | 600mA         | 0.15ohm max.  | -55°C to +125°C             | Kit |
| BLM15BX121SN1□ | 120ohm ±25%                | 600mA         | 0.17ohm max.  | -55°C to +125°C             | Kit |
| BLM15BX221SN1□ | 220ohm ±25%                | 450mA         | 0.27ohm max.  | -55°C to +125°C             | Kit |
| BLM15BX471SN1□ | 470ohm ±25%                | 350mA         | 0.41ohm max.  | -55°C to +125°C             | Kit |
| BLM15BX601SN1□ | 600ohm ±25%                | 350mA         | 0.46ohm max.  | -55°C to +125°C             | Kit |
| BLM15BX102SN1□ | 1000ohm ±25%               | 300mA         | 0.65ohm max.  | -55°C to +125°C             | Kit |
| BLM15BX182SN1□ | 1800ohm ±25%               | 250mA         | 0.90ohm max.  | -55°C to +125°C             | Kit |

Number of Circuits: 1

### ■ Impedance-Frequency Characteristics

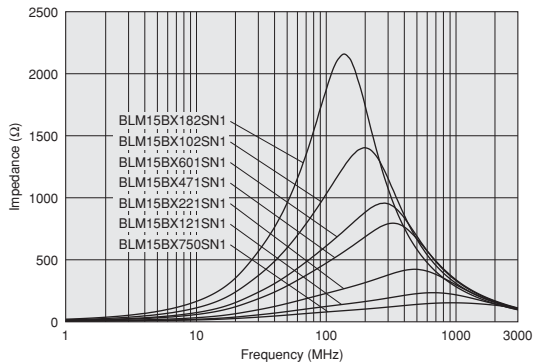

Continued on the following page.

Chip EMIFIL®

Chip Common Mode Choke Coil

Block Type EMIFIL®

Microwave Absorber

△Note • Please read rating and △CAUTION (for storage, operating, rating, soldering, mounting and handling) in this catalog to prevent smoking and/or burning, etc.  
• This catalog has only typical specifications. Therefore, please approve our product specifications or transact the approval sheet for product specifications before ordering.

Impedance-Frequency Characteristics

BLM15BX750SN1

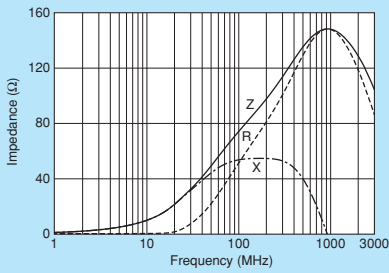

BLM15BX121SN1

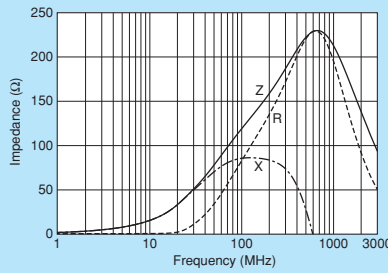

BLM15BX221SN1

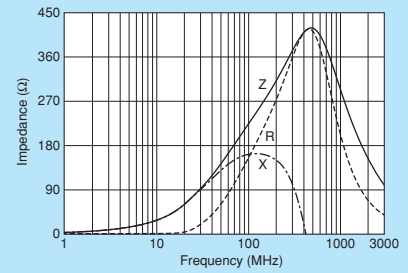

BLM15BX471SN1

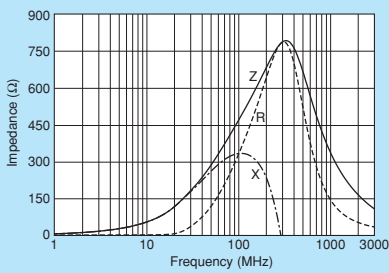

BLM15BX601SN1

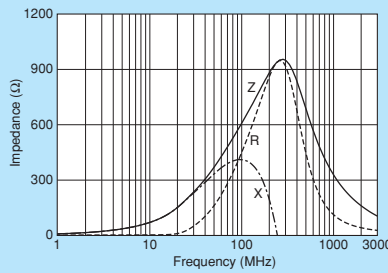

BLM15BX102SN1

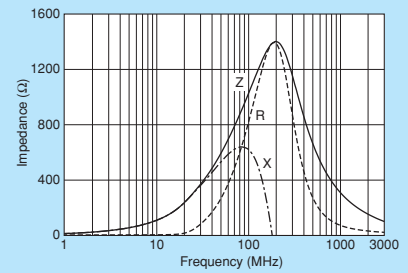

BLM15BX182SN1

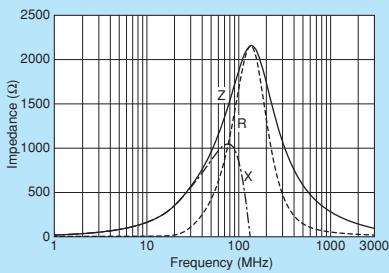

0402/1005 (inch/mm)  
Chip Ferrite Bead

Chip EMIFIL®

Chip Common Mode Choke Coil

Block Type EMIFIL®

Microwave Absorber

⚠Note • Please read rating and ⚠CAUTION (for storage, operating, rating, soldering, mounting and handling) in this catalog to prevent smoking and/or burning, etc.  
 • This catalog has only typical specifications. Therefore, please approve our product specifications or transact the approval sheet for product specifications before ordering.

# BLM15B Series 0402/1005 (inch/mm)



0402 size for high speed signal lines.

Chip Ferrite Bead  
0402/1005 (inch/mm)

Chip EMIFIL®

Chip Common Mode Choke Coil

Block Type EMIFIL®

Microwave Absorber

### ■ Dimensions

(in mm)

### ■ Equivalent Circuit

(Resistance element becomes dominant at high frequencies.)

### ■ Packaging

| Code | Packaging             | Minimum Quantity |
|------|-----------------------|------------------|
| D    | 180mm Reel Paper Tape | 10000            |
| J    | 330mm Reel Paper Tape | 50000            |
| B    | Bulk(Bag)             | 1000             |

Refer to pages from p.100 to p.103 for mounting information.

### ■ Rated Value (□: packaging code)

| Part Number    | Impedance<br>(at 100MHz/20°C) | Rated Current | DC Resistance | Operating<br>Temperature Range |     |
|----------------|-------------------------------|---------------|---------------|--------------------------------|-----|
| BLM15BD750SN1□ | 75ohm ±25%                    | 300mA         | 0.20ohm max.  | -55°C to +125°C                | Kit |
| BLM15BD121SN1□ | 120ohm ±25%                   | 300mA         | 0.30ohm max.  | -55°C to +125°C                | Kit |
| BLM15BD221SN1□ | 220ohm ±25%                   | 300mA         | 0.40ohm max.  | -55°C to +125°C                | Kit |
| BLM15BD471SN1□ | 470ohm ±25%                   | 200mA         | 0.60ohm max.  | -55°C to +125°C                | Kit |
| BLM15BD601SN1□ | 600ohm ±25%                   | 200mA         | 0.65ohm max.  | -55°C to +125°C                | Kit |
| BLM15BD102SN1□ | 1000ohm ±25%                  | 200mA         | 0.90ohm max.  | -55°C to +125°C                | Kit |
| BLM15BD182SN1□ | 1800ohm ±25%                  | 100mA         | 1.40ohm max.  | -55°C to +125°C                | Kit |
| BLM15BB050SN1□ | 5ohm ±25%                     | 500mA         | 0.08ohm max.  | -55°C to +125°C                | Kit |
| BLM15BB100SN1□ | 10ohm ±25%                    | 300mA         | 0.10ohm max.  | -55°C to +125°C                | Kit |
| BLM15BB220SN1□ | 22ohm ±25%                    | 300mA         | 0.20ohm max.  | -55°C to +125°C                | Kit |
| BLM15BB470SN1□ | 47ohm ±25%                    | 300mA         | 0.35ohm max.  | -55°C to +125°C                | Kit |
| BLM15BB750SN1□ | 75ohm ±25%                    | 300mA         | 0.40ohm max.  | -55°C to +125°C                | Kit |
| BLM15BB121SN1□ | 120ohm ±25%                   | 300mA         | 0.55ohm max.  | -55°C to +125°C                | Kit |
| BLM15BB221SN1□ | 220ohm ±25%                   | 200mA         | 0.80ohm max.  | -55°C to +125°C                | Kit |
| BLM15BC121SN1□ | 120ohm ±25%                   | 350mA         | 0.45ohm max.  | -55°C to +125°C                | Kit |
| BLM15BC241SN1□ | 240ohm ±25%                   | 250mA         | 0.70ohm max.  | -55°C to +125°C                | Kit |
| BLM15BA050SN1□ | 5ohm ±25%                     | 300mA         | 0.10ohm max.  | -55°C to +125°C                | Kit |
| BLM15BA100SN1□ | 10ohm ±25%                    | 300mA         | 0.20ohm max.  | -55°C to +125°C                | Kit |
| BLM15BA220SN1□ | 22ohm ±25%                    | 300mA         | 0.30ohm max.  | -55°C to +125°C                | Kit |
| BLM15BA330SN1□ | 33ohm ±25%                    | 300mA         | 0.40ohm max.  | -55°C to +125°C                | Kit |
| BLM15BA470SN1□ | 47ohm ±25%                    | 200mA         | 0.60ohm max.  | -55°C to +125°C                | Kit |
| BLM15BA750SN1□ | 75ohm ±25%                    | 200mA         | 0.80ohm max.  | -55°C to +125°C                | Kit |

Number of Circuits: 1

Continued on the following page.

△Note • Please read rating and △CAUTION (for storage, operating, rating, soldering, mounting and handling) in this catalog to prevent smoking and/or burning, etc.  
• This catalog has only typical specifications. Therefore, please approve our product specifications or transact the approval sheet for product specifications before ordering.



Impedance-Frequency Characteristics

BLM15BD Series

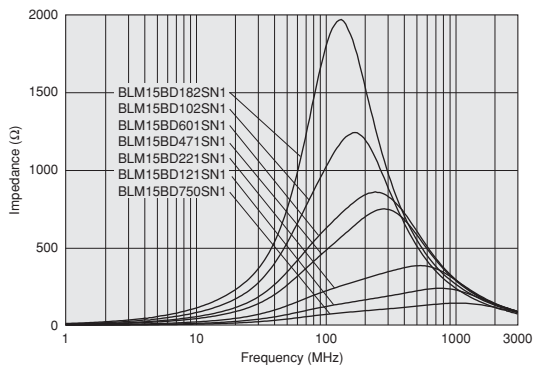

BLM15BB Series

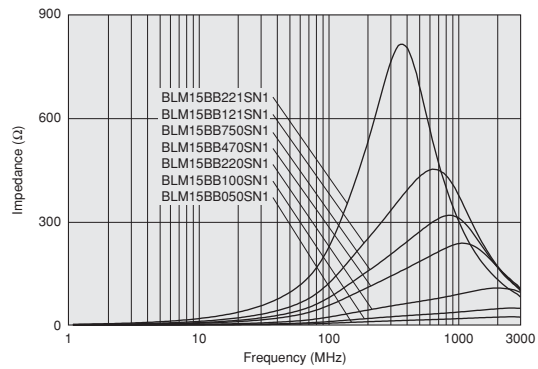

BLM15BC Series

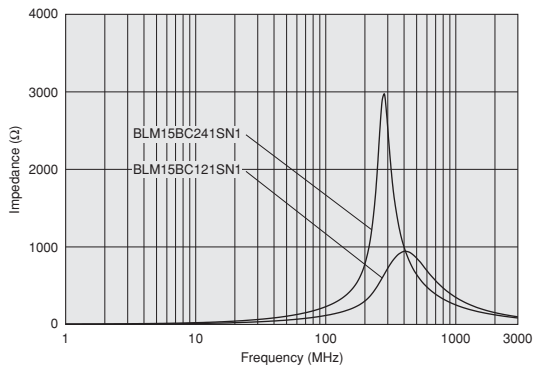

BLM15BA Series

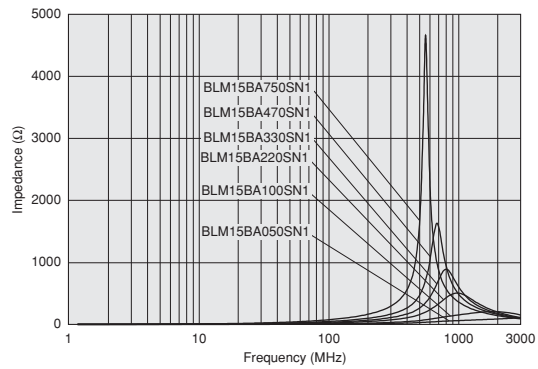

Impedance-Frequency Characteristics

BLM15BD750SN1

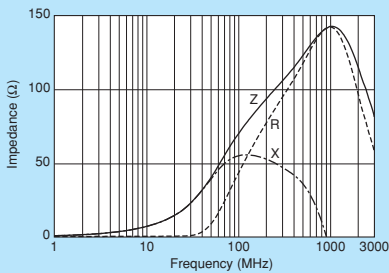

BLM15BD121SN1

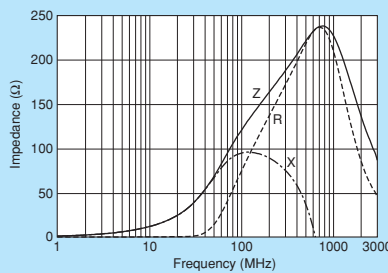

BLM15BD221SN1

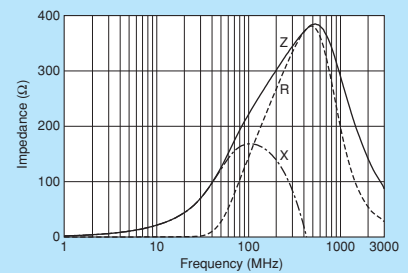

BLM15BD471SN1

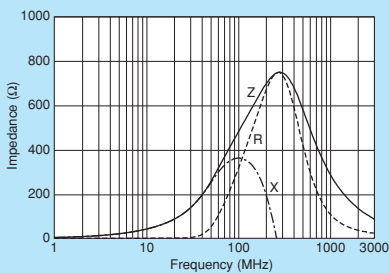

BLM15BD601SN1

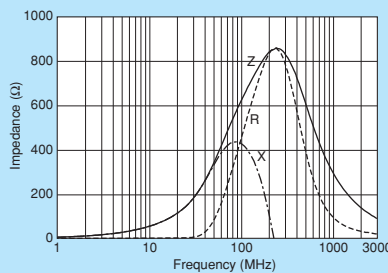

BLM15BD102SN1

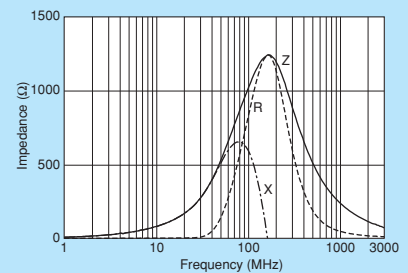

Continued on the following page.

**Note** • Please read rating and **CAUTION** (for storage, operating, rating, soldering, mounting and handling) in this catalog to prevent smoking and/or burning, etc.  
 • This catalog has only typical specifications. Therefore, please approve our product specifications or transact the approval sheet for product specifications before ordering.

Impedance-Frequency Characteristics

Chip Ferrite Bead  
 0402/1005 (inch/mm)

Chip EMIFIL®

Chip Common Mode Choke Coil

Block Type EMIFIL®

Microwave Absorber

BLM15BD182SN1

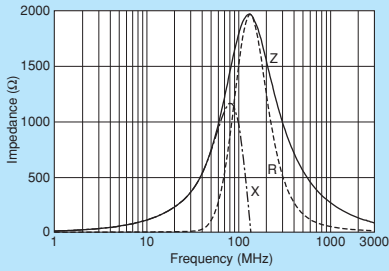

BLM15BB050SN1

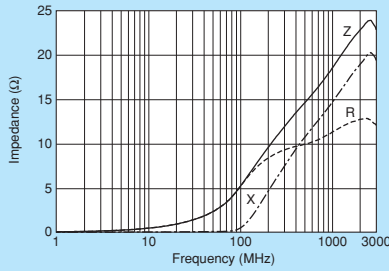

BLM15BB100SN1

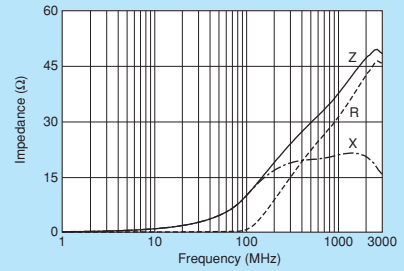

BLM15BB220SN1

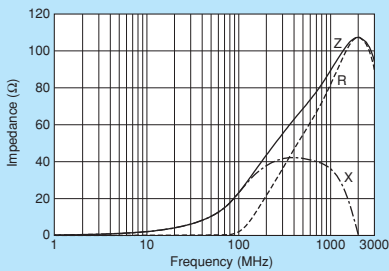

BLM15BB470SN1

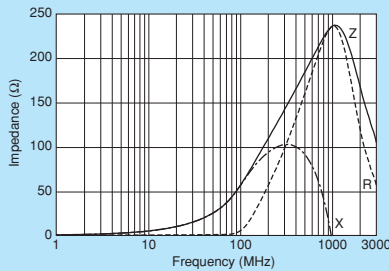

BLM15BB750SN1

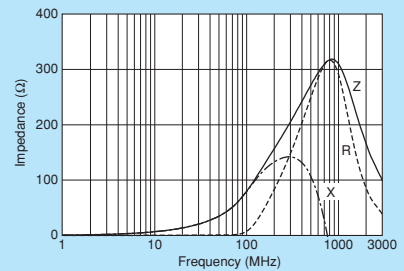

BLM15BB121SN1

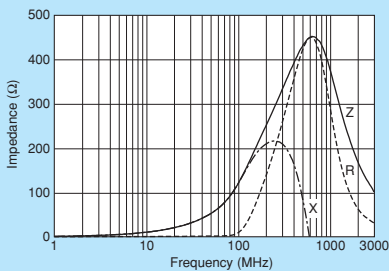

BLM15BB221SN1

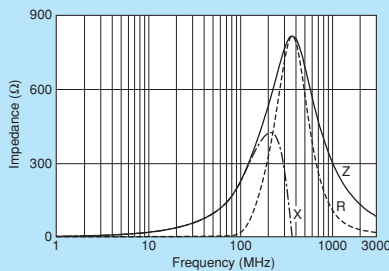

BLM15BC121SN1

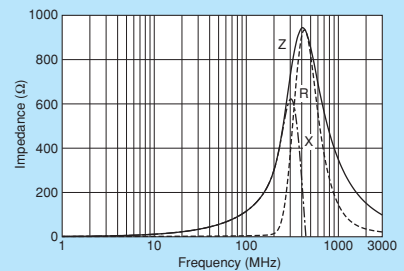

BLM15BC241SN1

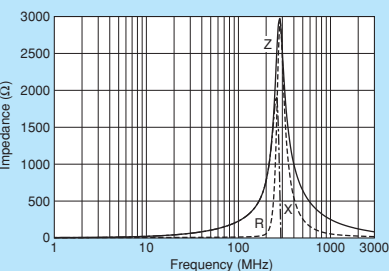

BLM15BA050SN1

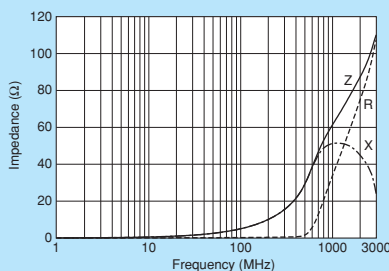

BLM15BA100SN1

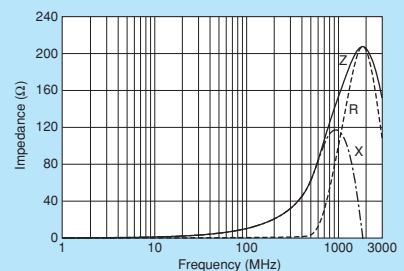

BLM15BA220SN1

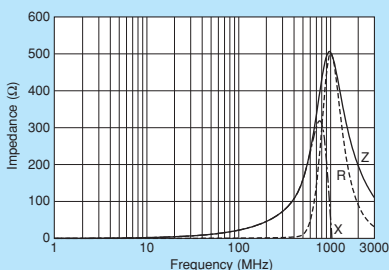

BLM15BA330SN1

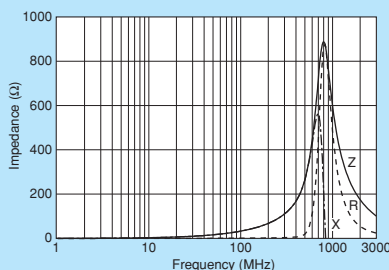

BLM15BA470SN1

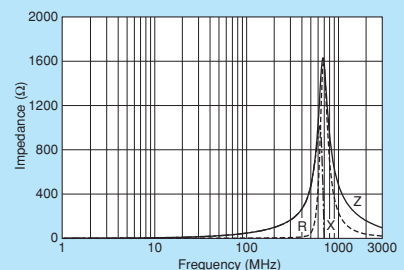

Continued on the following page.

⚠ Note • Please read rating and ⚠ CAUTION (for storage, operating, rating, soldering, mounting and handling) in this catalog to prevent smoking and/or burning, etc.  
 • This catalog has only typical specifications. Therefore, please approve our product specifications or transact the approval sheet for product specifications before ordering.

### Impedance-Frequency Characteristics

BLM15BA750SN1

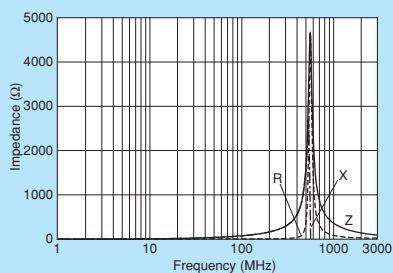

0402/1005 (inch/mm)  
Chip Ferrite Bead

Chip EMIFIL®

Chip Common Mode Choke Coil

Block Type EMIFIL®

Microwave Absorber

⚠Note • Please read rating and ⚠CAUTION (for storage, operating, rating, soldering, mounting and handling) in this catalog to prevent smoking and/or burning, etc.  
• This catalog has only typical specifications. Therefore, please approve our product specifications or transact the approval sheet for product specifications before ordering.

# BLM18P Series 0603/1608 (inch/mm)



## 0603 size for power lines.

\*Please refer to the products designed for both power lines and signal lines.

Chip Ferrite Bead  
0603/1608 (inch/mm)

Chip EMIFIL®

Chip Common Mode Choke Coil

Block Type EMIFIL®

Microwave Absorber

### ■ Dimensions

0.4±0.2  
1.6±0.15  
0.8±0.15  
0.8±0.15

■ Electrode  
(in mm)

### ■ Equivalent Circuit

(Resistance element becomes dominant at high frequencies.)

### ■ Packaging

| Code | Packaging             | Minimum Quantity |
|------|-----------------------|------------------|
| D    | 180mm Reel Paper Tape | 4000             |
| J    | 330mm Reel Paper Tape | 10000            |
| B    | Bulk(Bag)             | 1000             |

Refer to pages from p.100 to p.103 for mounting information.

### ■ Rated Value (□: packaging code)

| Part Number    | Impedance (at 100MHz/20°C) | Rated Current | DC Resistance | Operating Temperature Range |         |
|----------------|----------------------------|---------------|---------------|-----------------------------|---------|
| BLM18PG300SN1□ | 30ohm (Typ.)               | 1000mA        | 0.05ohm max.  | -55°C to +125°C             | Kit ≥1A |
| BLM18PG330SN1□ | 33ohm ±25%                 | 3000mA        | 0.025ohm max. | -55°C to +125°C             | Kit ≥3A |
| BLM18PG600SN1□ | 60ohm (Typ.)               | 500mA         | 0.10ohm max.  | -55°C to +125°C             | Kit     |
| BLM18PG121SN1□ | 120ohm ±25%                | 2000mA        | 0.05ohm max.  | -55°C to +125°C             | Kit ≥1A |
| BLM18PG181SN1□ | 180ohm ±25%                | 1500mA        | 0.09ohm max.  | -55°C to +125°C             | Kit ≥1A |
| BLM18PG221SN1□ | 220ohm ±25%                | 1400mA        | 0.10ohm max.  | -55°C to +125°C             | Kit ≥1A |
| BLM18PG331SN1□ | 330ohm ±25%                | 1200mA        | 0.15ohm max.  | -55°C to +125°C             | Kit ≥1A |
| BLM18PG471SN1□ | 470ohm ±25%                | 1000mA        | 0.20ohm max.  | -55°C to +125°C             | Kit ≥1A |

Number of Circuits: 1

### ■ Impedance-Frequency Characteristics

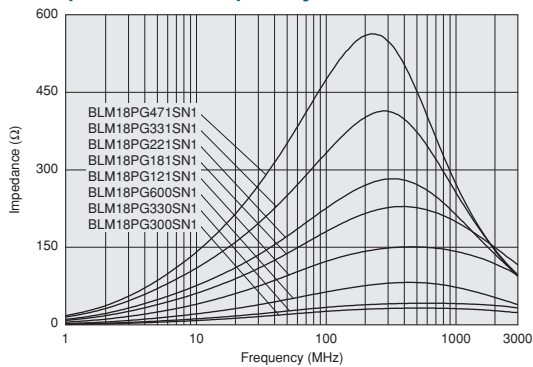

### ■ Notice (Rating)

In operating temperature exceeding +85°C, derating of current is necessary for BLM18PG series.

Please apply the derating curve shown in chart according to the operating temperature.

Derating of Rated Current

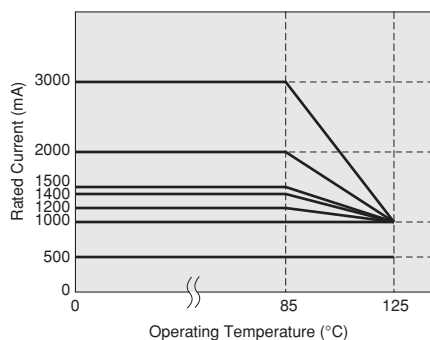

Continued on the following page. ↗

△Note • Please read rating and △CAUTION (for storage, operating, rating, soldering, mounting and handling) in this catalog to prevent smoking and/or burning, etc.  
• This catalog has only typical specifications. Therefore, please approve our product specifications or transact the approval sheet for product specifications before ordering.

Impedance-Frequency Characteristics

BLM18PG300SN1

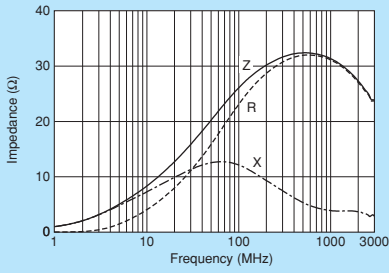

BLM18PG330SN1

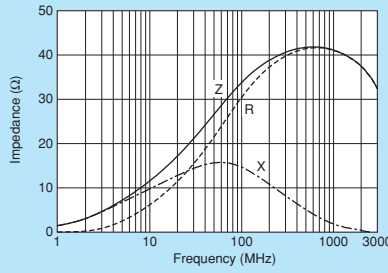

BLM18PG600SN1

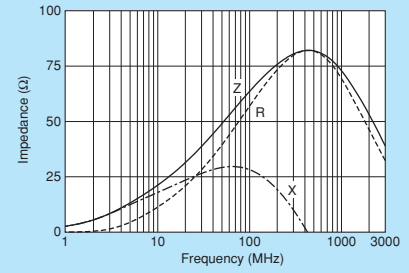

BLM18PG121SN1

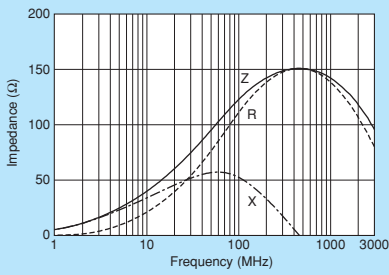

BLM18PG181SN1

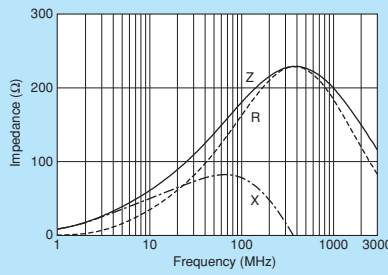

BLM18PG221SN1

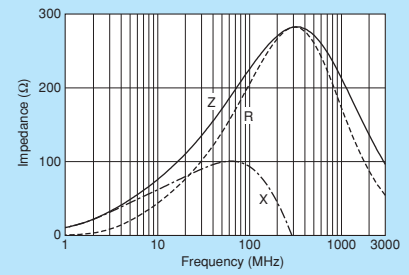

BLM18PG331SN1

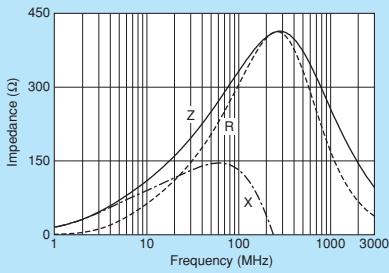

BLM18PG471SN1

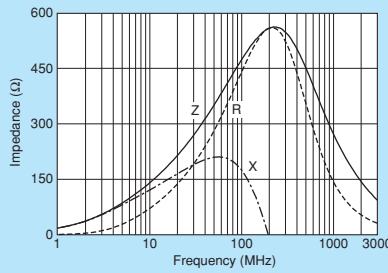

0603/1608 (inch/mm)  
Chip Ferrite Bead

Chip EMIFIL®

Chip Common Mode Choke Coil

Block Type EMIFIL®

Microwave Absorber

⚠Note • Please read rating and ⚠CAUTION (for storage, operating, rating, soldering, mounting and handling) in this catalog to prevent smoking and/or burning, etc.  
 • This catalog has only typical specifications. Therefore, please approve our product specifications or transact the approval sheet for product specifications before ordering.

# BLM18K Series 0603/1608 (inch/mm)



6A max., high performance type for power lines up to 600ohm.

\*Please refer to the products designed for both power lines and signal lines.

Chip Ferrite Bead  
0603/1608 (inch/mm)

Chip EMIFIL®

Chip Common Mode Choke Coil

Block Type EMIFIL®

Microwave Absorber



### ■ Dimensions

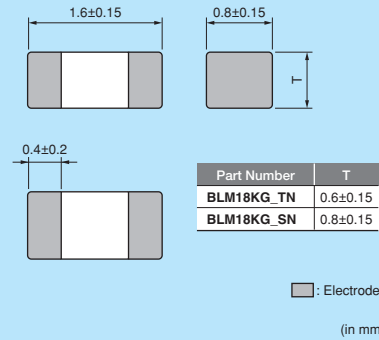

### ■ Equivalent Circuit

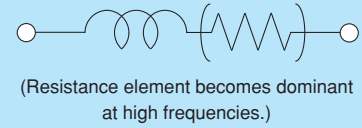

### ■ Packaging

| Code | Packaging             | Minimum Quantity |
|------|-----------------------|------------------|
| D    | 180mm Reel Paper Tape | 4000             |
| J    | 330mm Reel Paper Tape | 10000            |
| B    | Bulk(Bag)             | 1000             |

Refer to pages from p.100 to p.103 for mounting information.

### ■ Rated Value (□: packaging code)

| Part Number    | Impedance (at 100MHz/20°C) | Rated Current | DC Resistance | Operating Temperature Range | Kit | Current |
|----------------|----------------------------|---------------|---------------|-----------------------------|-----|---------|
| BLM18KG260TN1□ | 26ohm ±25%                 | 6000mA        | 0.007ohm max. | -55°C to +125°C             | Kit | ≥3A     |
| BLM18KG300TN1□ | 30ohm ±25%                 | 5000mA        | 0.010ohm max. | -55°C to +125°C             | Kit | ≥3A     |
| BLM18KG700TN1□ | 70ohm ±25%                 | 3500mA        | 0.022ohm max. | -55°C to +125°C             | Kit | ≥3A     |
| BLM18KG101TN1□ | 100ohm ±25%                | 3000mA        | 0.030ohm max. | -55°C to +125°C             | Kit | ≥3A     |
| BLM18KG121TN1□ | 120ohm ±25%                | 3000mA        | 0.030ohm max. | -55°C to +125°C             | Kit | ≥3A     |
| BLM18KG221SN1□ | 220ohm ±25%                | 2200mA        | 0.050ohm max. | -55°C to +125°C             | Kit | ≥1A     |
| BLM18KG331SN1□ | 330ohm ±25%                | 1700mA        | 0.080ohm max. | -55°C to +125°C             | Kit | ≥1A     |
| BLM18KG471SN1□ | 470ohm ±25%                | 1500mA        | 0.130ohm max. | -55°C to +125°C             | Kit | ≥1A     |
| BLM18KG601SN1□ | 600ohm ±25%                | 1300mA        | 0.150ohm max. | -55°C to +125°C             | Kit | ≥1A     |

Number of Circuits: 1

### ■ Impedance-Frequency Characteristics

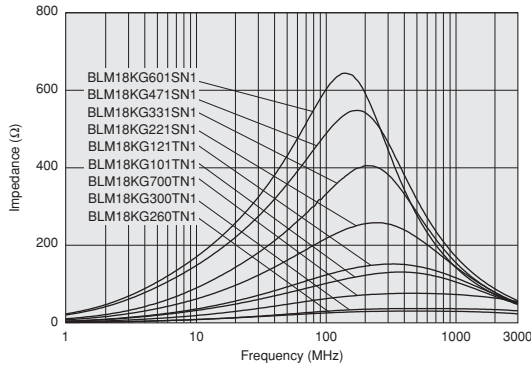

### ■ Notice (Rating)

In operating temperature exceeding +85°C, derating of current is necessary for BLM18KG series. Please apply the derating curve shown in chart according to the operating temperature.

Derating of Rated Current

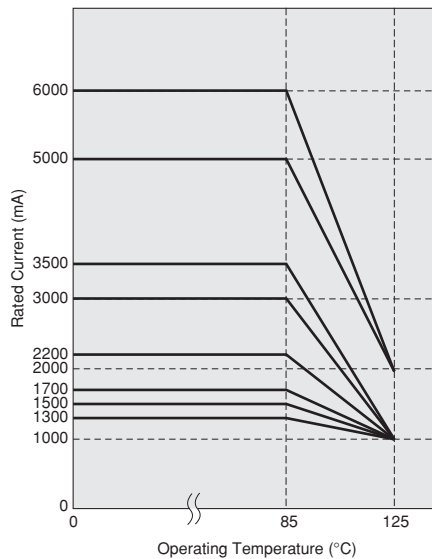

Continued on the following page.

△Note • Please read rating and △CAUTION (for storage, operating, rating, soldering, mounting and handling) in this catalog to prevent smoking and/or burning, etc.  
• This catalog has only typical specifications. Therefore, please approve our product specifications or transact the approval sheet for product specifications before ordering.

Impedance-Frequency Characteristics

BLM18KG260TN1

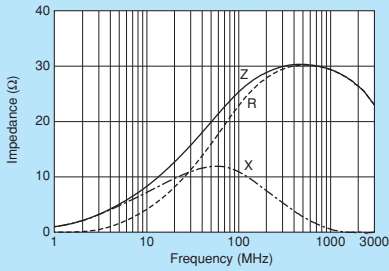

BLM18KG300TN1

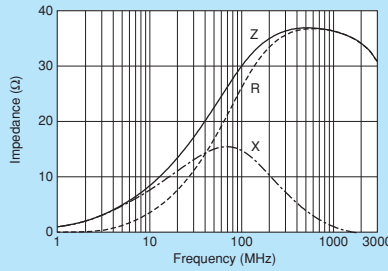

BLM18KG700TN1

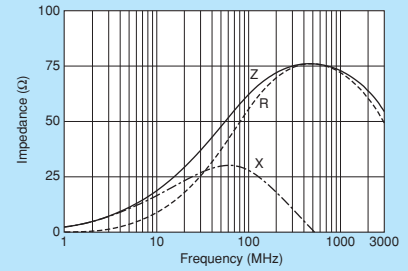

BLM18KG101TN1

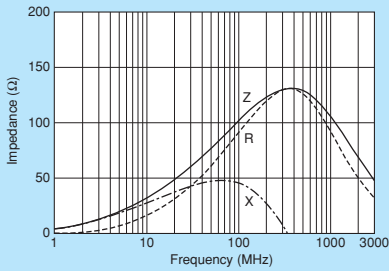

BLM18KG121TN1

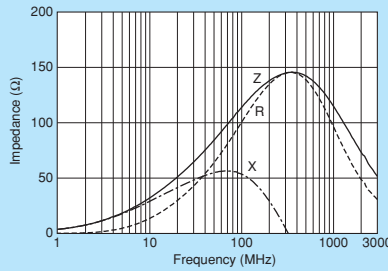

BLM18KG221SN1

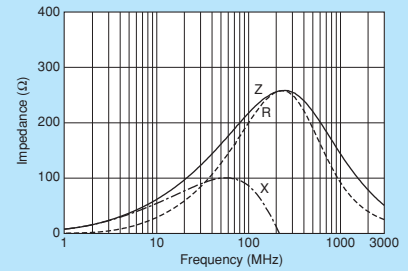

BLM18KG331SN1

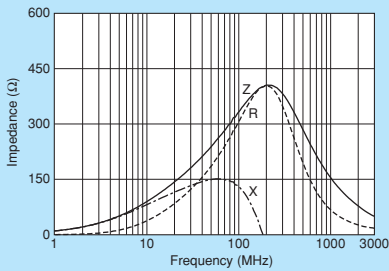

BLM18KG471SN1

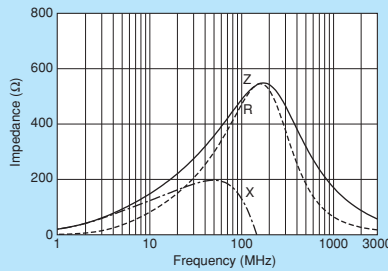

BLM18KG601SN1

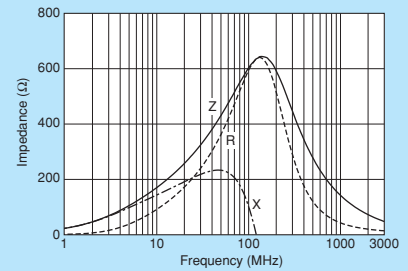

0603/1608 (inch/mm)  
Chip Ferrite Bead

Chip EMIFIL®

Chip Common Mode Choke Coil

Block Type EMIFIL®

Microwave Absorber

⚠Note • Please read rating and ⚠CAUTION (for storage, operating, rating, soldering, mounting and handling) in this catalog to prevent smoking and/or burning, etc.  
 • This catalog has only typical specifications. Therefore, please approve our product specifications or transact the approval sheet for product specifications before ordering.

# BLM18S Series 0603/1608 (inch/mm)



6A max., high performance type for power lines.

\*Please refer to the products designed for both power lines and signal lines.

Chip Ferrite Bead  
0603/1608 (inch/mm)



### ■ Dimensions

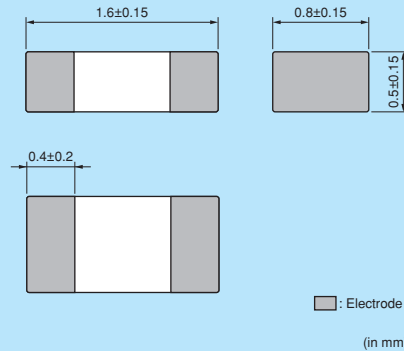

### ■ Equivalent Circuit

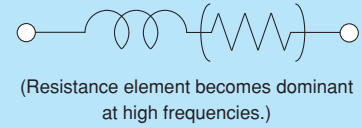

### ■ Packaging

| Code | Packaging             | Minimum Quantity |
|------|-----------------------|------------------|
| D    | 180mm Reel Paper Tape | 10000            |
| J    | 330mm Reel Paper Tape | 30000            |
| B    | Bulk(Bag)             | 1000             |

Refer to pages from p.100 to p.103 for mounting information.

### ■ Rated Value (□: packaging code)

| Part Number    | Impedance (at 100MHz/20°C) | Rated Current | DC Resistance | Operating Temperature Range | Kit | ≥3A |
|----------------|----------------------------|---------------|---------------|-----------------------------|-----|-----|
| BLM18SG260TN1□ | 26ohm ±25%                 | 6000mA        | 0.007ohm max. | -55°C to +125°C             | Kit | ≥3A |
| BLM18SG700TN1□ | 70ohm ±25%                 | 4000mA        | 0.020ohm max. | -55°C to +125°C             | Kit | ≥3A |
| BLM18SG121TN1□ | 120ohm ±25%                | 3000mA        | 0.025ohm max. | -55°C to +125°C             | Kit | ≥3A |
| BLM18SG221TN1□ | 220ohm ±25%                | 2500mA        | 0.040ohm max. | -55°C to +125°C             | Kit | ≥1A |
| BLM18SG331TN1□ | 330ohm ±25%                | 1500mA        | 0.070ohm max. | -55°C to +125°C             | Kit | ≥1A |

Number of Circuits: 1

### ■ Impedance-Frequency Characteristics

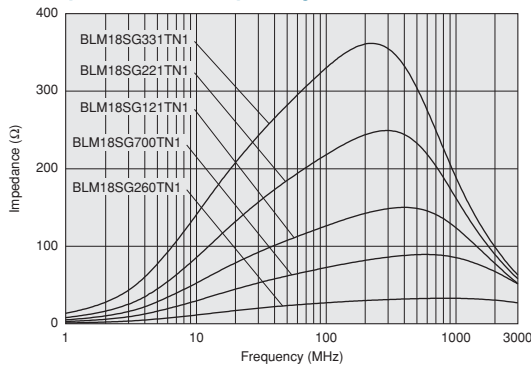

### ■ Notice (Rating)

In operating temperature exceeding +85°C, derating of current is necessary for BLM18SG series.

Please apply the derating curve shown in chart according to the operating temperature.

Derating of Rated Current

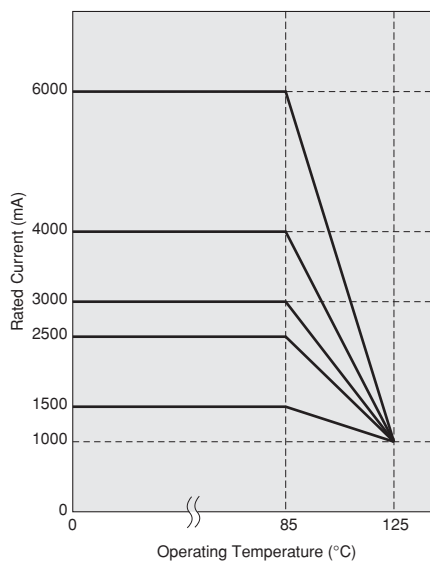

Continued on the following page.

△Note • Please read rating and △CAUTION (for storage, operating, rating, soldering, mounting and handling) in this catalog to prevent smoking and/or burning, etc.  
• This catalog has only typical specifications. Therefore, please approve our product specifications or transact the approval sheet for product specifications before ordering.

Chip EMIFIL®

Chip Common Mode Choke Coil

Block Type EMIFIL®

Microwave Absorber



Impedance-Frequency Characteristics

BLM18SG260TN1

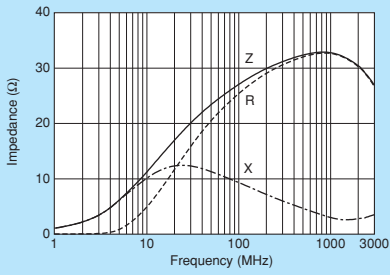

BLM18SG700TN1

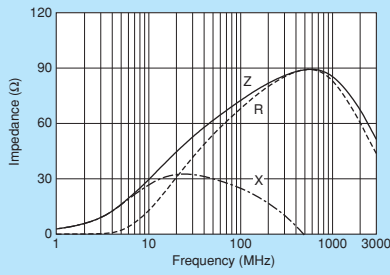

BLM18SG121TN1

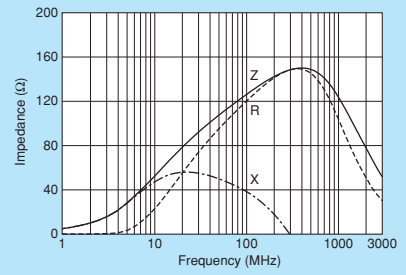

BLM18SG221TN1

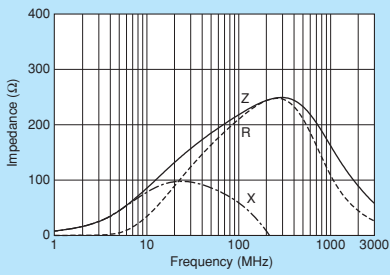

BLM18SG331TN1

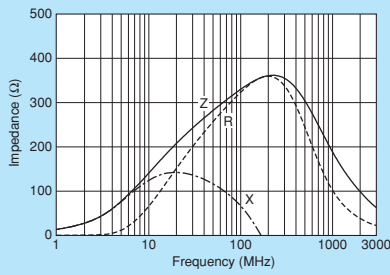

0603/1608 (inch/mm)  
 Chip Ferrite Bead

Chip EMIFIL®

Chip Common Mode Choke Coil

Block Type EMIFIL®

Microwave Absorber

⚠Note • Please read rating and ⚠CAUTION (for storage, operating, rating, soldering, mounting and handling) in this catalog to prevent smoking and/or burning, etc.  
 • This catalog has only typical specifications. Therefore, please approve our product specifications or transact the approval sheet for product specifications before ordering.

# BLM18A Series 0603/1608 (inch/mm)



## 0603 size for general signal lines.

\*Please refer to BLM15A for downsizing.

Chip Ferrite Bead  
0603/1608 (inch/mm)



### ■ Dimensions

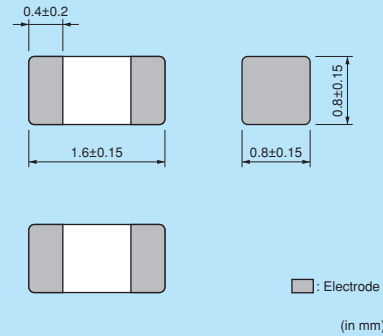

### ■ Equivalent Circuit

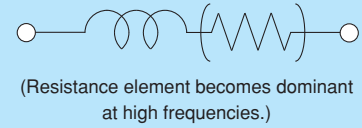

### ■ Packaging

| Code | Packaging             | Minimum Quantity |
|------|-----------------------|------------------|
| D    | 180mm Reel Paper Tape | 4000             |
| J    | 330mm Reel Paper Tape | 10000            |
| B    | Bulk(Bag)             | 1000             |

Refer to pages from p.100 to p.103 for mounting information.

### ■ Rated Value (□: packaging code)

| Part Number    | Impedance (at 100MHz/20°C) | Rated Current | DC Resistance | Operating Temperature Range |     |
|----------------|----------------------------|---------------|---------------|-----------------------------|-----|
| BLM18AG121SN1□ | 120ohm ±25%                | 500mA         | 0.18ohm max.  | -55°C to +125°C             | Kit |
| BLM18AG151SN1□ | 150ohm ±25%                | 500mA         | 0.25ohm max.  | -55°C to +125°C             | Kit |
| BLM18AG221SN1□ | 220ohm ±25%                | 500mA         | 0.25ohm max.  | -55°C to +125°C             | Kit |
| BLM18AG331SN1□ | 330ohm ±25%                | 500mA         | 0.30ohm max.  | -55°C to +125°C             | Kit |
| BLM18AG471SN1□ | 470ohm ±25%                | 500mA         | 0.35ohm max.  | -55°C to +125°C             | Kit |
| BLM18AG601SN1□ | 600ohm ±25%                | 500mA         | 0.38ohm max.  | -55°C to +125°C             | Kit |
| BLM18AG102SN1□ | 1000ohm ±25%               | 400mA         | 0.50ohm max.  | -55°C to +125°C             | Kit |

Number of Circuits: 1

Chip EMIFIL®

Chip Common Mode Choke Coil

Block Type EMIFIL®

Microwave Absorber

### ■ Impedance-Frequency Characteristics

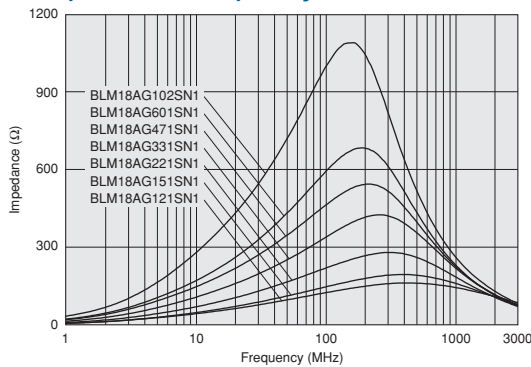

### ■ Impedance-Frequency Characteristics

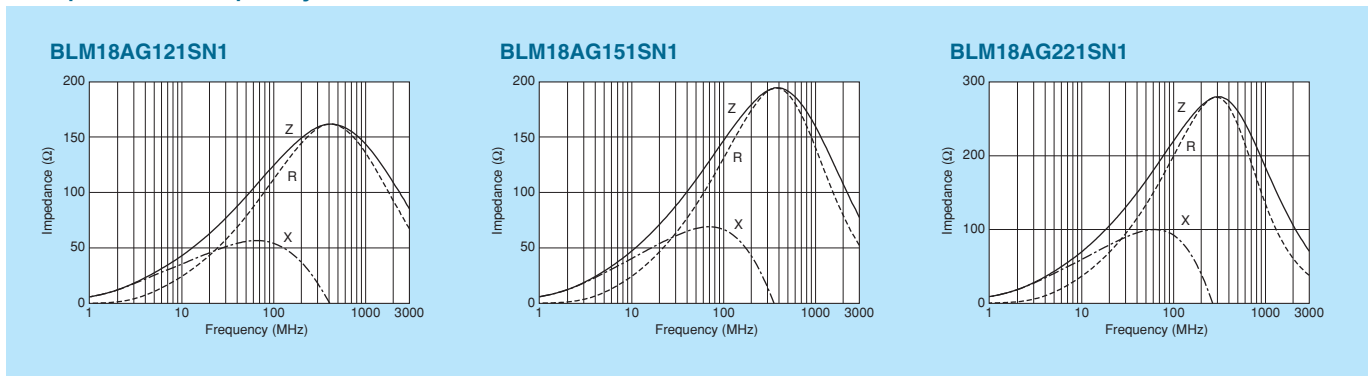

Continued on the following page.

△Note • Please read rating and △CAUTION (for storage, operating, rating, soldering, mounting and handling) in this catalog to prevent smoking and/or burning, etc.  
• This catalog has only typical specifications. Therefore, please approve our product specifications or transact the approval sheet for product specifications before ordering.

Impedance-Frequency Characteristics

BLM18AG331SN1

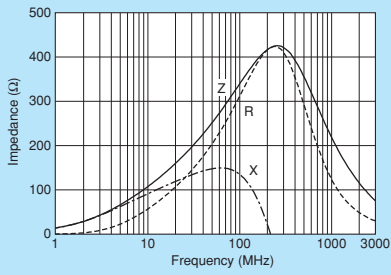

BLM18AG471SN1

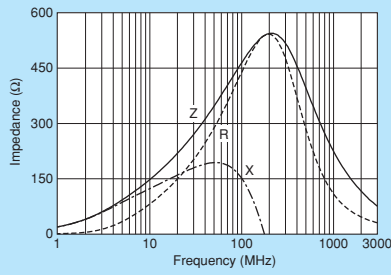

BLM18AG601SN1

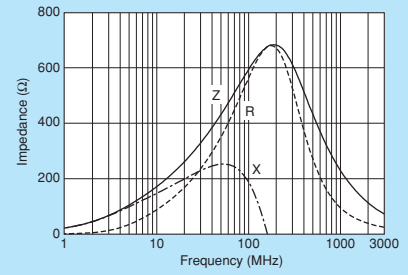

BLM18AG102SN1

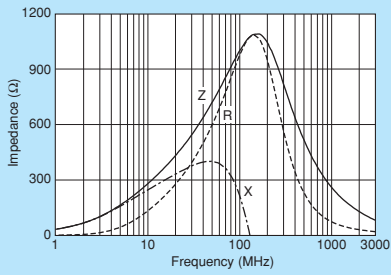

0603/1608 (inch/mm)  
 Chip Ferrite Bead

Chip EMIFIL®

Chip Common Mode Choke Coil

Block Type EMIFIL®

Microwave Absorber

⚠ Note • Please read rating and ⚠ CAUTION (for storage, operating, rating, soldering, mounting and handling) in this catalog to prevent smoking and/or burning, etc.  
 • This catalog has only typical specifications. Therefore, please approve our product specifications or transact the approval sheet for product specifications before ordering.

# BLM18B Series 0603/1608 (inch/mm)



## 0603 size for high speed signal lines.

\*Please refer to BLM15B for downsizing.

### ■ Dimensions

(in mm)

### ■ Equivalent Circuit

(Resistance element becomes dominant at high frequencies.)

### ■ Packaging

| Code | Packaging             | Minimum Quantity |
|------|-----------------------|------------------|
| D    | 180mm Reel Paper Tape | 4000             |
| J    | 330mm Reel Paper Tape | 10000            |
| B    | Bulk(Bag)             | 1000             |

Refer to pages from p.100 to p.103 for mounting information.

### ■ Rated Value (□: packaging code)

| Part Number    | Impedance (at 100MHz/20°C) | Rated Current | DC Resistance | Operating Temperature Range |     |
|----------------|----------------------------|---------------|---------------|-----------------------------|-----|
| BLM18BD470SN1□ | 47ohm ±25%                 | 500mA         | 0.30ohm max.  | -55°C to +125°C             | Kit |
| BLM18BD121SN1□ | 120ohm ±25%                | 200mA         | 0.40ohm max.  | -55°C to +125°C             | Kit |
| BLM18BD151SN1□ | 150ohm ±25%                | 200mA         | 0.40ohm max.  | -55°C to +125°C             | Kit |
| BLM18BD221SN1□ | 220ohm ±25%                | 200mA         | 0.45ohm max.  | -55°C to +125°C             | Kit |
| BLM18BD331SN1□ | 330ohm ±25%                | 200mA         | 0.50ohm max.  | -55°C to +125°C             | Kit |
| BLM18BD421SN1□ | 420ohm ±25%                | 200mA         | 0.55ohm max.  | -55°C to +125°C             | Kit |
| BLM18BD471SN1□ | 470ohm ±25%                | 200mA         | 0.55ohm max.  | -55°C to +125°C             | Kit |
| BLM18BD601SN1□ | 600ohm ±25%                | 200mA         | 0.65ohm max.  | -55°C to +125°C             | Kit |
| BLM18BD102SN1□ | 1000ohm ±25%               | 100mA         | 0.85ohm max.  | -55°C to +125°C             | Kit |
| BLM18BD152SN1□ | 1500ohm ±25%               | 50mA          | 1.20ohm max.  | -55°C to +125°C             | Kit |
| BLM18BD182SN1□ | 1800ohm ±25%               | 50mA          | 1.50ohm max.  | -55°C to +125°C             | Kit |
| BLM18BD222SN1□ | 2200ohm ±25%               | 50mA          | 1.50ohm max.  | -55°C to +125°C             | Kit |
| BLM18BD252SN1□ | 2500ohm ±25%               | 50mA          | 1.50ohm max.  | -55°C to +125°C             | Kit |
| BLM18BB050SN1□ | 5ohm ±25%                  | 700mA         | 0.05ohm max.  | -55°C to +125°C             | Kit |
| BLM18BB100SN1□ | 10ohm ±25%                 | 700mA         | 0.10ohm max.  | -55°C to +125°C             | Kit |
| BLM18BB220SN1□ | 22ohm ±25%                 | 600mA         | 0.20ohm max.  | -55°C to +125°C             | Kit |
| BLM18BB470SN1□ | 47ohm ±25%                 | 550mA         | 0.25ohm max.  | -55°C to +125°C             | Kit |
| BLM18BB600SN1□ | 60ohm ±25%                 | 550mA         | 0.25ohm max.  | -55°C to +125°C             | Kit |
| BLM18BB750SN1□ | 75ohm ±25%                 | 500mA         | 0.30ohm max.  | -55°C to +125°C             | Kit |
| BLM18BB121SN1□ | 120ohm ±25%                | 500mA         | 0.30ohm max.  | -55°C to +125°C             | Kit |
| BLM18BB141SN1□ | 140ohm ±25%                | 450mA         | 0.35ohm max.  | -55°C to +125°C             |     |
| BLM18BB151SN1□ | 150ohm ±25%                | 450mA         | 0.37ohm max.  | -55°C to +125°C             | Kit |
| BLM18BB221SN1□ | 220ohm ±25%                | 450mA         | 0.45ohm max.  | -55°C to +125°C             | Kit |
| BLM18BB331SN1□ | 330ohm ±25%                | 400mA         | 0.58ohm max.  | -55°C to +125°C             | Kit |
| BLM18BB471SN1□ | 470ohm ±25%                | 300mA         | 0.85ohm max.  | -55°C to +125°C             | Kit |
| BLM18BA050SN1□ | 5ohm ±25%                  | 500mA         | 0.20ohm max.  | -55°C to +125°C             | Kit |
| BLM18BA100SN1□ | 10ohm ±25%                 | 500mA         | 0.25ohm max.  | -55°C to +125°C             | Kit |
| BLM18BA220SN1□ | 22ohm ±25%                 | 500mA         | 0.35ohm max.  | -55°C to +125°C             |     |
| BLM18BA470SN1□ | 47ohm ±25%                 | 300mA         | 0.55ohm max.  | -55°C to +125°C             | Kit |
| BLM18BA750SN1□ | 75ohm ±25%                 | 300mA         | 0.70ohm max.  | -55°C to +125°C             | Kit |
| BLM18BA121SN1□ | 120ohm ±25%                | 200mA         | 0.90ohm max.  | -55°C to +125°C             | Kit |

Number of Circuits: 1

Continued on the following page.

△Note • Please read rating and △CAUTION (for storage, operating, rating, soldering, mounting and handling) in this catalog to prevent smoking and/or burning, etc.  
 • This catalog has only typical specifications. Therefore, please approve our product specifications or transact the approval sheet for product specifications before ordering.

Chip Ferrite Bead 0603/1608 (inch/mm)  
Chip EMIFIL®  
Chip Common Mode Choke Coil  
Block Type EMIFIL®  
Microwave Absorber

**Impedance-Frequency Characteristics**  
 BLM18BD Series (47ohm to 420ohm)

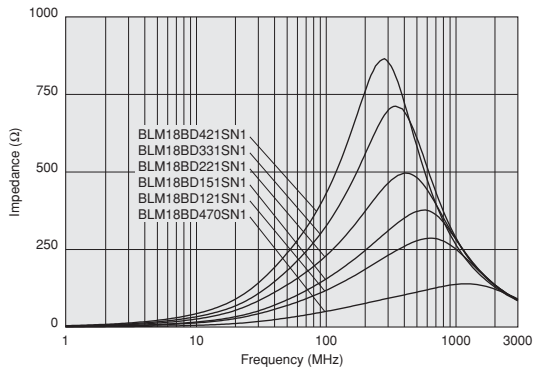

**BLM18BD Series (470ohm to 2500ohm)**

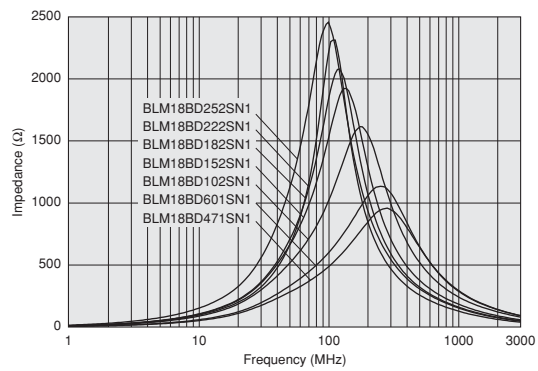

**BLM18BB Series (5ohm to 75ohm)**

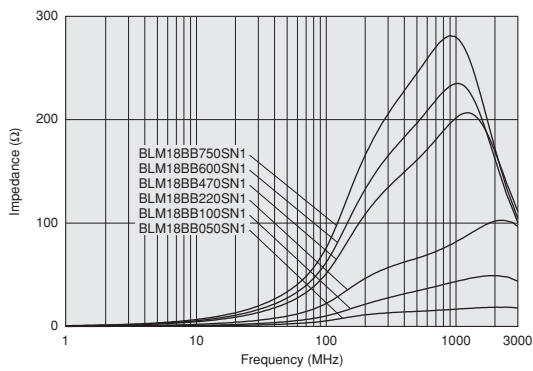

**BLM18BB Series (120ohm to 470ohm)**

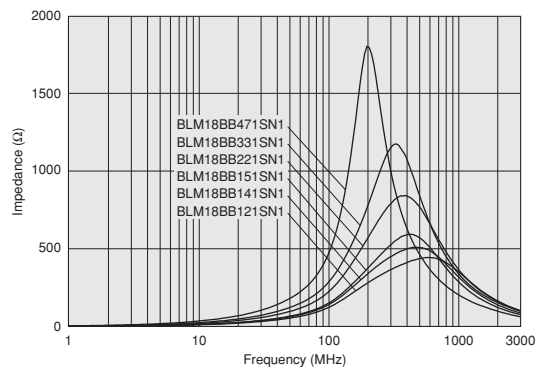

**BLM18BA Series (5ohm to 220ohm)**

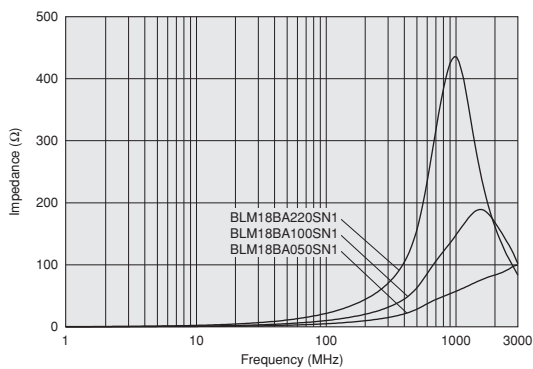

**BLM18BA Series (47ohm to 120ohm)**

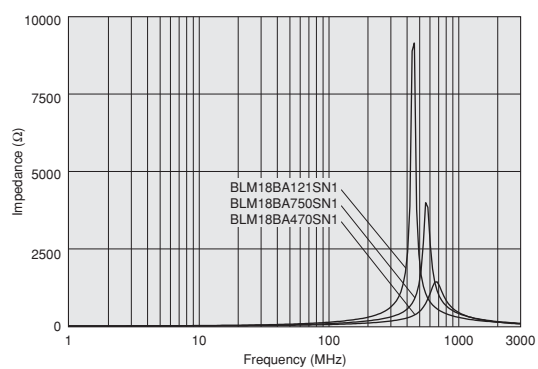

**Impedance-Frequency Characteristics**

**BLM18BD470SN1**

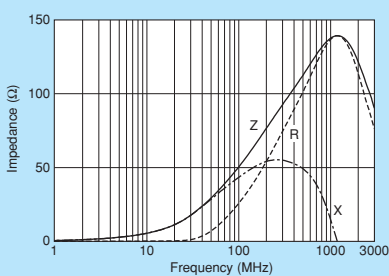

**BLM18BD121SN1**

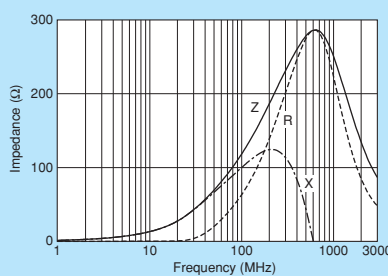

**BLM18BD151SN1**

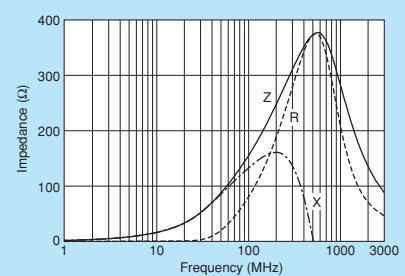

Continued on the following page.

**Note** • Please read rating and **CAUTION** (for storage, operating, rating, soldering, mounting and handling) in this catalog to prevent smoking and/or burning, etc.  
 • This catalog has only typical specifications. Therefore, please approve our product specifications or transact the approval sheet for product specifications before ordering.

Impedance-Frequency Characteristics

Chip Ferrite Bead  
 0603/1608 (inch/mm)

Chip EMIFIL®

Chip Common Mode Choke Coil

Block Type EMIFIL®

Microwave Absorber

BLM18BD221SN1

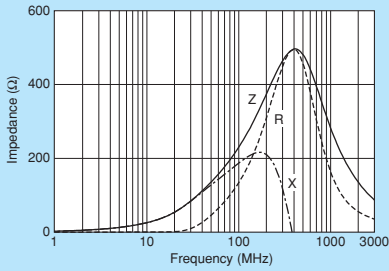

BLM18BD331SN1

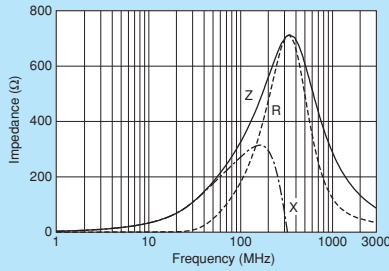

BLM18BD421SN1

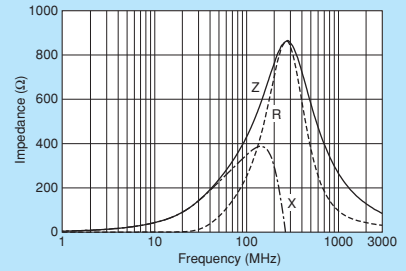

BLM18BD471SN1

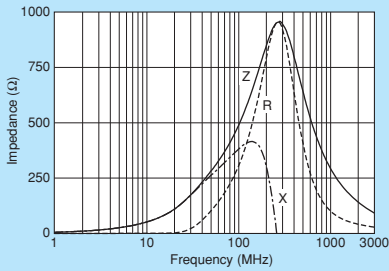

BLM18BD601SN1

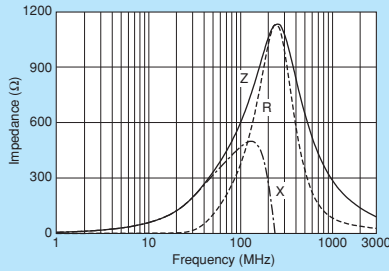

BLM18BD102SN1

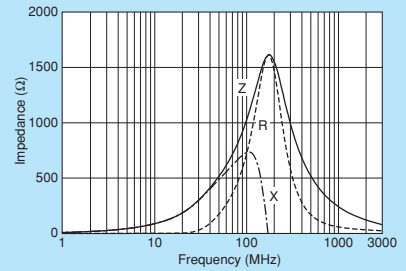

BLM18BD152SN1

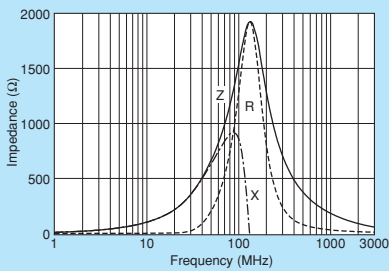

BLM18BD182SN1

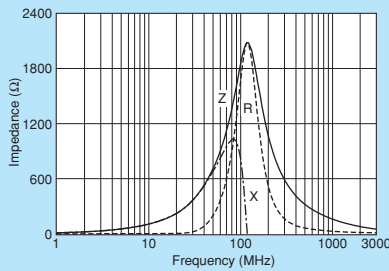

BLM18BD222SN1

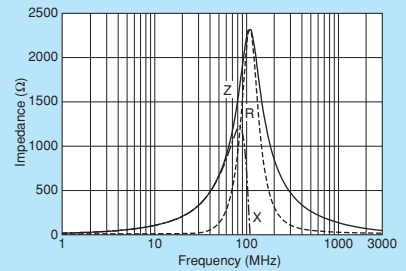

BLM18BD252SN1

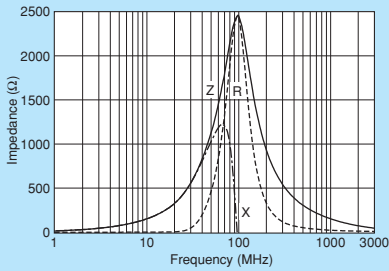

BLM18BB050SN1

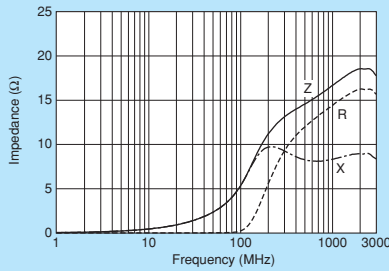

BLM18BB100SN1

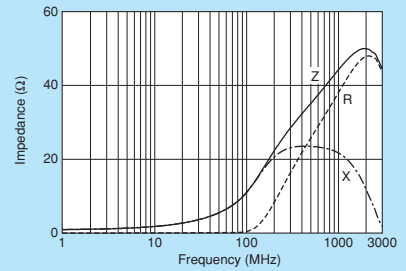

BLM18BB220SN1

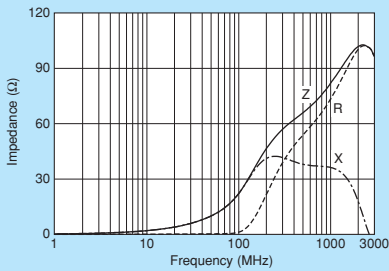

BLM18BB470SN1

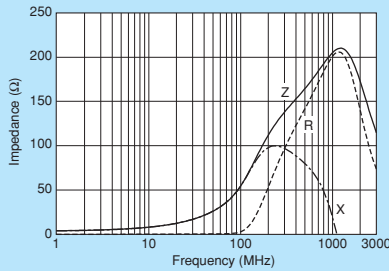

BLM18BB600SN1

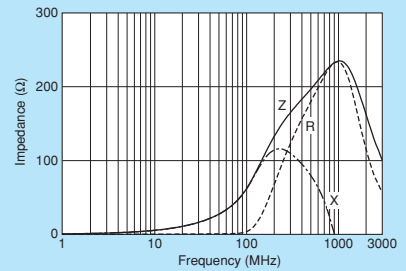

Continued on the following page.

⚠ Note • Please read rating and ⚠ CAUTION (for storage, operating, rating, soldering, mounting and handling) in this catalog to prevent smoking and/or burning, etc.  
 • This catalog has only typical specifications. Therefore, please approve our product specifications or transact the approval sheet for product specifications before ordering.

Impedance-Frequency Characteristics

BLM18BB750SN1

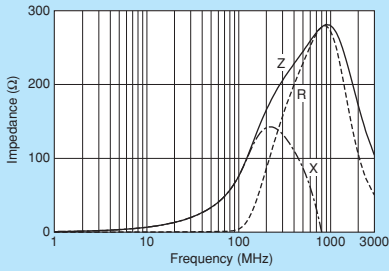

BLM18BB121SN1

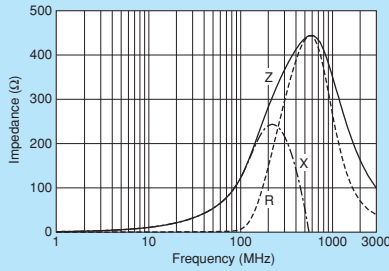

BLM18BB141SN1

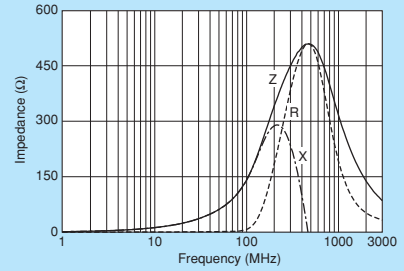

BLM18BB151SN1

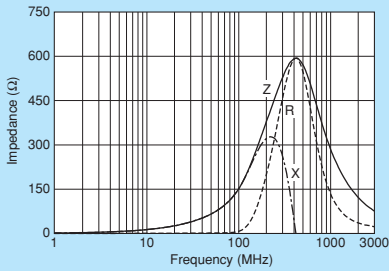

BLM18BB221SN1

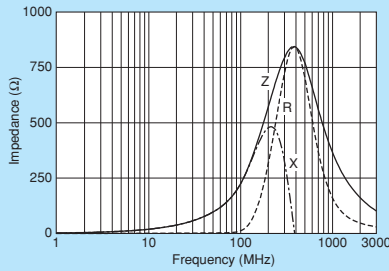

BLM18BB331SN1

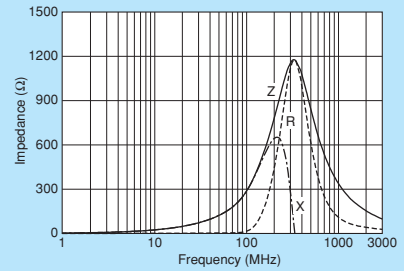

BLM18BB471SN1

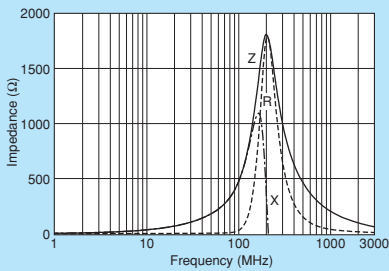

BLM18BA050SN1

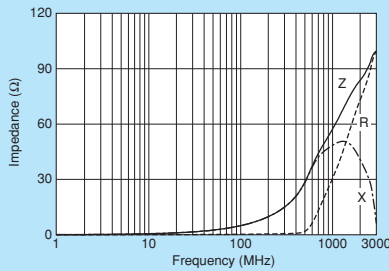

BLM18BA100SN1

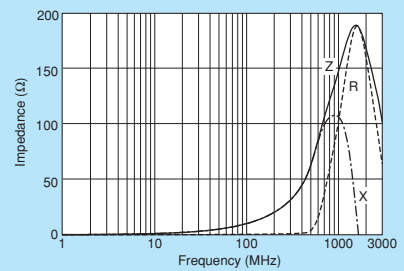

BLM18BA220SN1

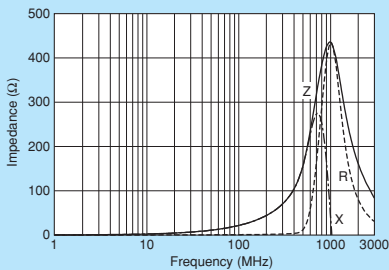

BLM18BA470SN1

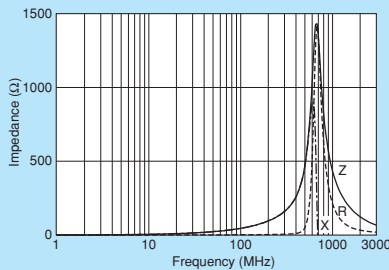

BLM18BA750SN1

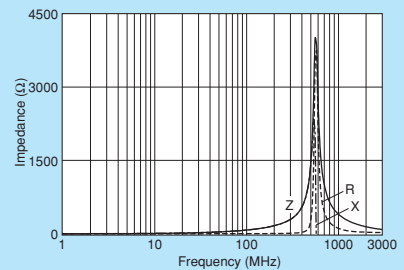

BLM18BA121SN1

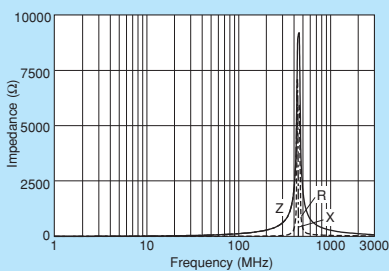

0603/1608 (inch/mm)  
Chip Ferrite Bead

Chip EMIFIL®

Chip Common Mode Choke Coil

Block Type EMIFIL®

Microwave Absorber

⚠Note • Please read rating and ⚠CAUTION (for storage, operating, rating, soldering, mounting and handling) in this catalog to prevent smoking and/or burning, etc.  
 • This catalog has only typical specifications. Therefore, please approve our product specifications or transact the approval sheet for product specifications before ordering.

# BLM18T Series 0603/1608 (inch/mm)



Thin 0603 size for general signal lines.

Chip Ferrite Bead  
0603/1608 (inch/mm)



### ■ Dimensions

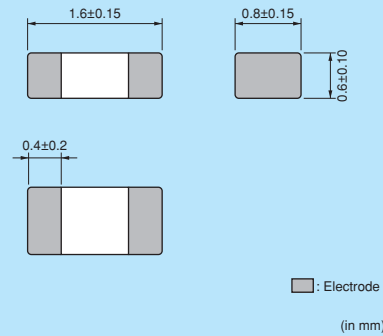

### ■ Equivalent Circuit

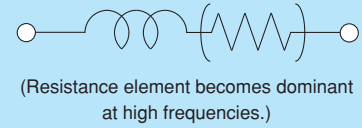

### ■ Packaging

| Code | Packaging             | Minimum Quantity |
|------|-----------------------|------------------|
| D    | 180mm Reel Paper Tape | 10000            |
| B    | Bulk (Bag)            | 1000             |

Refer to pages from p.100 to p.103 for mounting information.

### ■ Rated Value (□: packaging code)

| Part Number    | Impedance (at 100MHz/20°C) | Rated Current | DC Resistance | Operating Temperature Range |
|----------------|----------------------------|---------------|---------------|-----------------------------|
| BLM18TG121TN1□ | 120ohm ±25%                | 200mA         | 0.25ohm max.  | -55°C to +125°C             |
| BLM18TG221TN1□ | 220ohm ±25%                | 200mA         | 0.30ohm max.  | -55°C to +125°C             |
| BLM18TG601TN1□ | 600ohm ±25%                | 200mA         | 0.45ohm max.  | -55°C to +125°C             |
| BLM18TG102TN1□ | 1000ohm ±25%               | 100mA         | 0.60ohm max.  | -55°C to +125°C             |

Number of Circuits: 1

### ■ Impedance-Frequency Characteristics

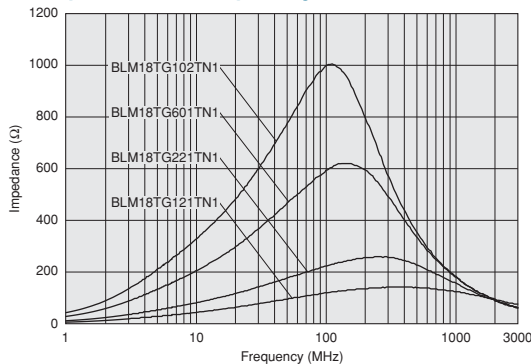

### ■ Impedance-Frequency Characteristics

#### BLM18TG121TN1

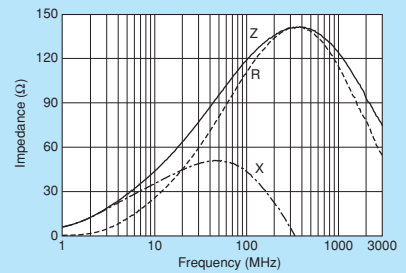

#### BLM18TG221TN1

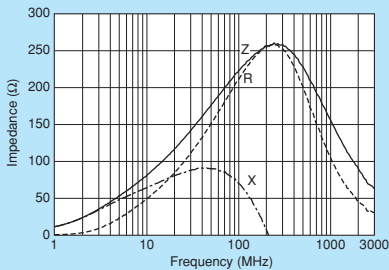

#### BLM18TG601TN1

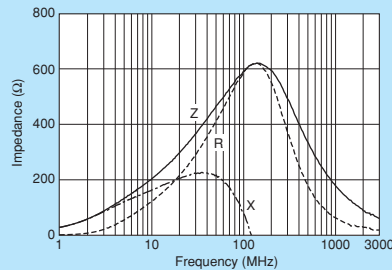

#### BLM18TG102TN1

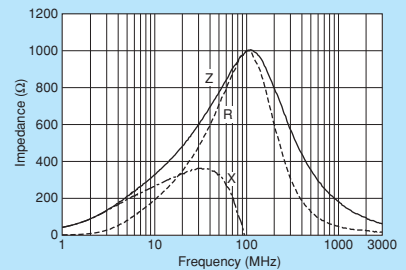

△Note • Please read rating and △CAUTION (for storage, operating, rating, soldering, mounting and handling) in this catalog to prevent smoking and/or burning, etc.  
 • This catalog has only typical specifications. Therefore, please approve our product specifications or transact the approval sheet for product specifications before ordering.

Chip Common Mode Choke Coil

Block Type EMIFIL®

Microwave Absorber



# BLM18R Series 0603/1608 (inch/mm)



For digital I/F. Reduces the distortion of waveform created by resonance.



### ■ Dimensions

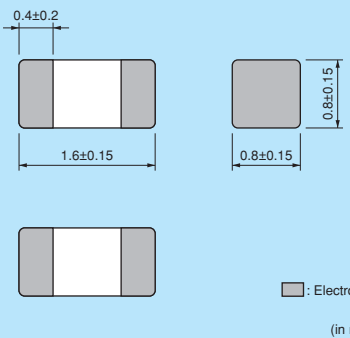

(in mm)

### ■ Equivalent Circuit



(Resistance element becomes dominant at high frequencies.)

### ■ Packaging

| Code | Packaging             | Minimum Quantity |
|------|-----------------------|------------------|
| D    | 180mm Reel Paper Tape | 4000             |
| J    | 330mm Reel Paper Tape | 10000            |
| B    | Bulk(Bag)             | 1000             |

Refer to pages from p.100 to p.103 for mounting information.

### ■ Rated Value (□: packaging code)

| Part Number    | Impedance (at 100MHz/20°C) | Rated Current | DC Resistance | Operating Temperature Range |
|----------------|----------------------------|---------------|---------------|-----------------------------|
| BLM18RK121SN1□ | 120ohm ±25%                | 200mA         | 0.25ohm max.  | -55°C to +125°C             |
| BLM18RK221SN1□ | 220ohm ±25%                | 200mA         | 0.30ohm max.  | -55°C to +125°C             |
| BLM18RK471SN1□ | 470ohm ±25%                | 200mA         | 0.50ohm max.  | -55°C to +125°C             |
| BLM18RK601SN1□ | 600ohm ±25%                | 200mA         | 0.60ohm max.  | -55°C to +125°C             |
| BLM18RK102SN1□ | 1000ohm ±25%               | 200mA         | 0.80ohm max.  | -55°C to +125°C             |

Number of Circuits: 1

### ■ Impedance-Frequency Characteristics

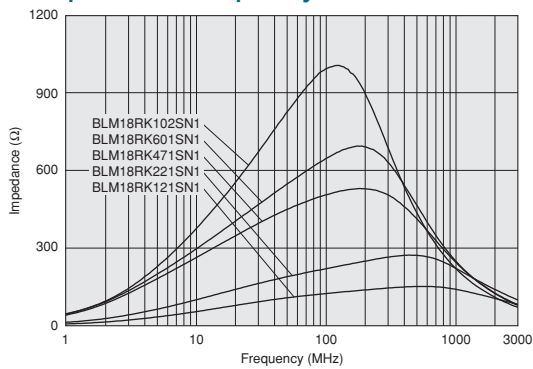

### ■ Impedance-Frequency Characteristics

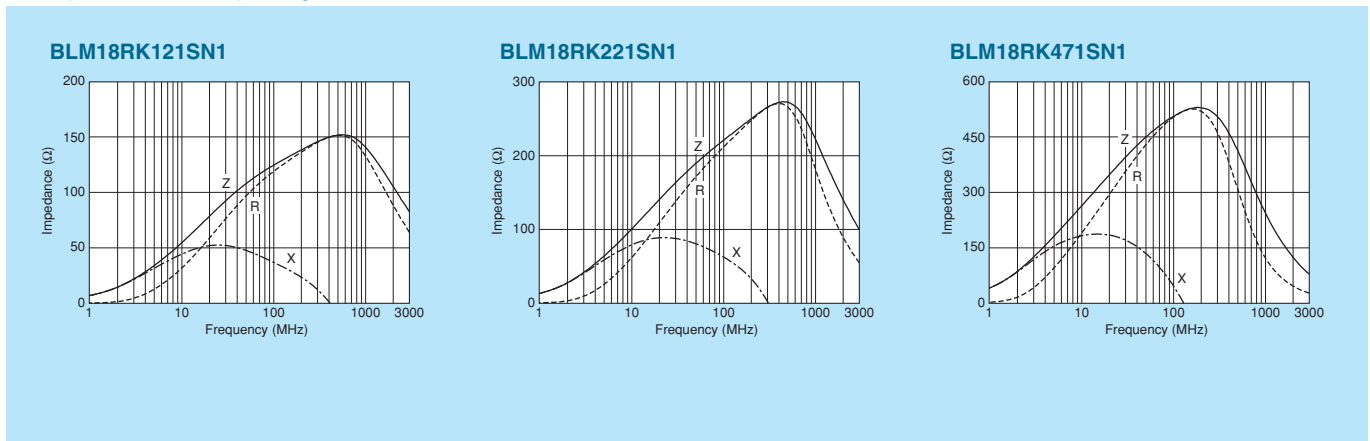

Continued on the following page.

⚠Note • Please read rating and ⚠CAUTION (for storage, operating, rating, soldering, mounting and handling) in this catalog to prevent smoking and/or burning, etc.  
 • This catalog has only typical specifications. Therefore, please approve our product specifications or transact the approval sheet for product specifications before ordering.

■ Impedance-Frequency Characteristics

Chip Ferrite Bead  
 0603/1608 (inch/mm)

Chip EMIFIL®

Chip Common Mode Choke Coil

Block Type EMIFIL®

Microwave Absorber

BLM18RK601SN1

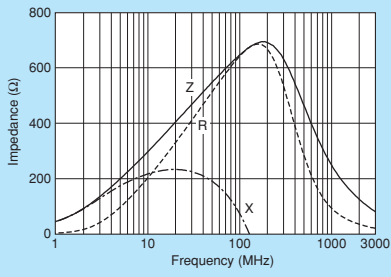

BLM18RK102SN1

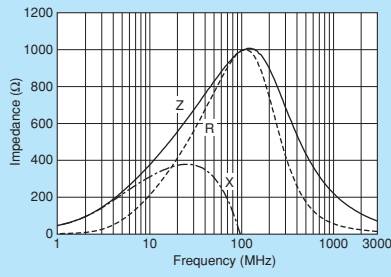

⚠Note • Please read rating and ⚠CAUTION (for storage, operating, rating, soldering, mounting and handling) in this catalog to prevent smoking and/or burning, etc.  
 • This catalog has only typical specifications. Therefore, please approve our product specifications or transact the approval sheet for product specifications before ordering.

## Waveform Distortion Suppressing Performance of BLM□□R Series

### Measuring Circuits

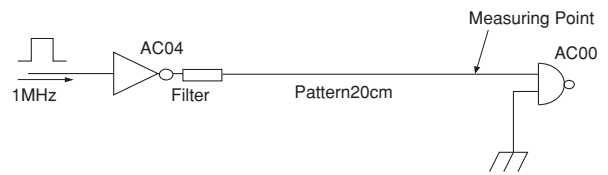

| Type of Filter  | EMI Suppression Effect / Description  |  |                                    |
|---|---|--|------------------------------------|
| Initial<br>(No filter)  | <p>Signal waveform (100nsec/div, 2V/div)</p>  | <p>Expand (10nsec/div, 2V/div)</p>           | <p>Spectrum</p>                    |
|   | <p>Ringing is caused on the signal waveform.<br/>Such ringing contains several hundred MHz harmonic components and generates noise.</p>   |  |                                    |
|   | Resistor (47Ω)<br>is used   | <p>Signal waveform (100nsec/div, 2V/div)</p> | <p>Expand (10nsec/div, 2V/div)</p> |
| <p>Comparing initial waveform, ringing is suppressed a little.<br/>However, high level waveform distortion still remains.</p> |   |  |                                    |
| BLM18RK221SN1<br>(220Ω at 100MHz)<br>is used  |   | <p>Signal waveform (100nsec/div, 2V/div)</p> | <p>Expand (10nsec/div, 2V/div)</p> |
|   | <p>BLM18R has excellent performance for noise suppression and waveform distortion suppression.<br/>BLM18R suppresses drastically not only the spectrum level in more than 100MHz range but waveform distortion.</p> |  |                                    |

△Note • Please read rating and △CAUTION (for storage, operating, rating, soldering, mounting and handling) in this catalog to prevent smoking and/or burning, etc.  
• This catalog has only typical specifications. Therefore, please approve our product specifications or transact the approval sheet for product specifications before ordering.

# BLM21P Series 0805/2012 (inch/mm)



## 0805 size for power lines.

\*Please refer to the products designed for both power lines and signal lines. \*Please refer to BLM18K for downsizing.

Chip Ferrite Bead  
0805/2012 (inch/mm)



### ■ Dimensions

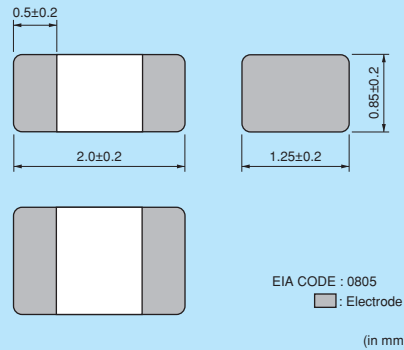

### ■ Equivalent Circuit

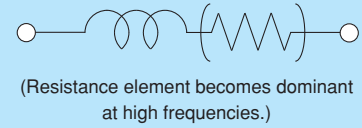

### ■ Packaging

| Code | Packaging             | Minimum Quantity |
|------|-----------------------|------------------|
| D    | 180mm Reel Paper Tape | 4000             |
| J    | 330mm Reel Paper Tape | 10000            |
| B    | Bulk(Bag)             | 1000             |

Refer to pages from p.100 to p.103 for mounting information.

### ■ Rated Value (□: packaging code)

| Part Number    | Impedance (at 100MHz/20°C) | Rated Current | DC Resistance | Operating Temperature Range | Kit | Current |
|----------------|----------------------------|---------------|---------------|-----------------------------|-----|---------|
| BLM21PG220SN1□ | 22ohm ±25%                 | 6000mA        | 0.009ohm max. | -55°C to +125°C             | Kit | ≥3A     |
| BLM21PG300SN1□ | 30ohm (Typ.)               | 4000mA        | 0.014ohm max. | -55°C to +125°C             | Kit | ≥3A     |
| BLM21PG600SN1□ | 60ohm ±25%                 | 3500mA        | 0.02ohm max.  | -55°C to +125°C             | Kit | ≥3A     |
| BLM21PG121SN1□ | 120ohm ±25%                | 3000mA        | 0.03ohm max.  | -55°C to +125°C             | Kit | ≥3A     |
| BLM21PG221SN1□ | 220ohm ±25%                | 2000mA        | 0.045ohm max. | -55°C to +125°C             | Kit | ≥1A     |
| BLM21PG331SN1□ | 330ohm ±25%                | 1500mA        | 0.07ohm max.  | -55°C to +125°C             | Kit | ≥1A     |

Number of Circuits: 1

### ■ Impedance-Frequency Characteristics

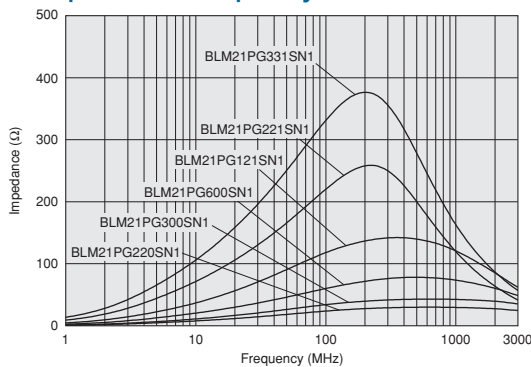

### ■ Notice (Rating)

In operating temperature exceeding +85°C, derating of current is necessary for BLM21PG series.

Please apply the derating curve shown in chart according to the operating temperature.

#### Derating of Rated Current

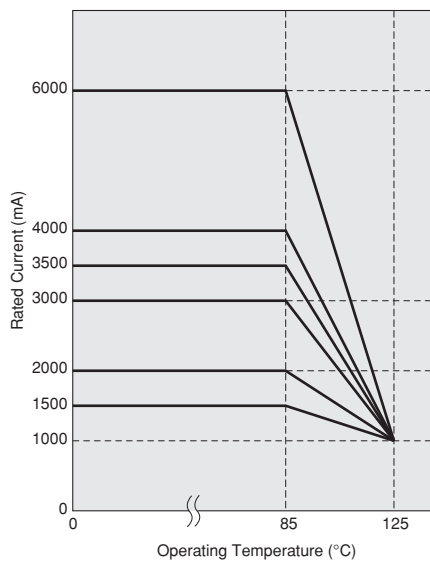

Continued on the following page.

⚠Note • Please read rating and ⚠CAUTION (for storage, operating, rating, soldering, mounting and handling) in this catalog to prevent smoking and/or burning, etc.  
 • This catalog has only typical specifications. Therefore, please approve our product specifications or transact the approval sheet for product specifications before ordering.

Chip EMIFIL®

Chip Common Mode Choke Coil

Block Type EMIFIL®

Microwave Absorber

Impedance-Frequency Characteristics

BLM21PG220SN1

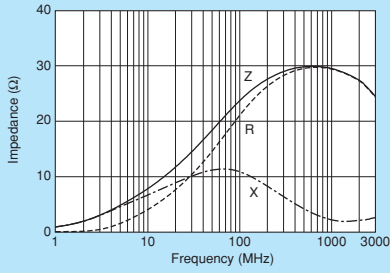

BLM21PG300SN1

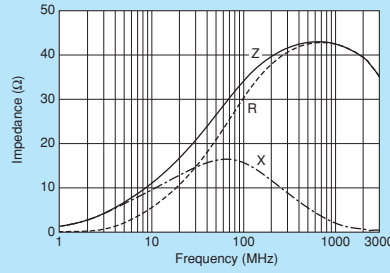

BLM21PG600SN1

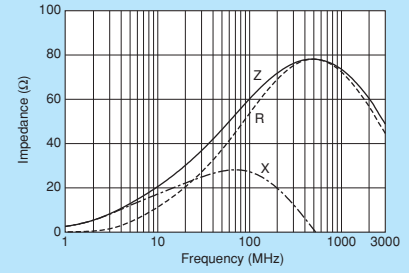

BLM21PG121SN1

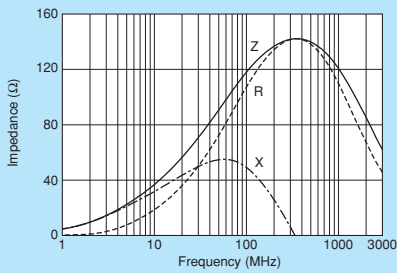

BLM21PG221SN1

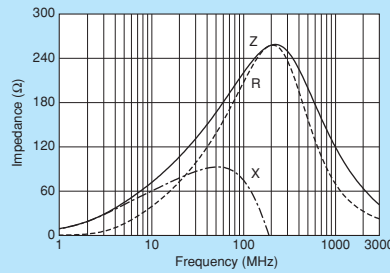

BLM21PG331SN1

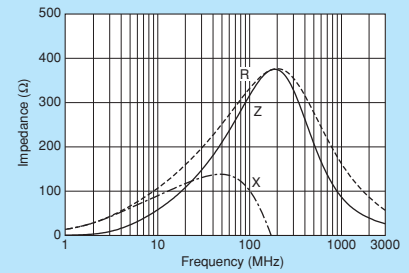

0805/2012 (inch/mm)  
 Chip Ferrite Bead

Chip EMIFIL®

Chip Common Mode Choke Coil

Block Type EMIFIL®

Microwave Absorber

⚠Note • Please read rating and ⚠CAUTION (for storage, operating, rating, soldering, mounting and handling) in this catalog to prevent smoking and/or burning, etc.  
 • This catalog has only typical specifications. Therefore, please approve our product specifications or transact the approval sheet for product specifications before ordering.

# BLM21A Series 0805/2012 (inch/mm)



0805 size for general signal lines.

Chip Ferrite Bead  
0805/2012 (inch/mm)



### Dimensions

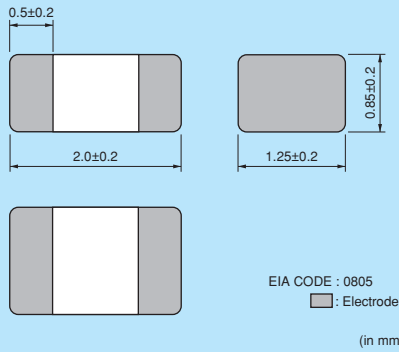

### Equivalent Circuit

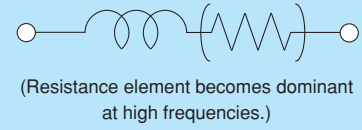

### Packaging

| Code | Packaging             | Minimum Quantity |
|------|-----------------------|------------------|
| D    | 180mm Reel Paper Tape | 4000             |
| J    | 330mm Reel Paper Tape | 10000            |
| B    | Bulk(Bag)             | 1000             |

Refer to pages from p.100 to p.103 for mounting information.

### Rated Value (□: packaging code)

| Part Number    | Impedance (at 100MHz/20°C) | Rated Current | DC Resistance | Operating Temperature Range |     |
|----------------|----------------------------|---------------|---------------|-----------------------------|-----|
| BLM21AG121SN1□ | 120ohm ±25%                | 800mA         | 0.10ohm max.  | -55°C to +125°C             | Kit |
| BLM21AG151SN1□ | 150ohm ±25%                | 800mA         | 0.10ohm max.  | -55°C to +125°C             | Kit |
| BLM21AG221SN1□ | 220ohm ±25%                | 800mA         | 0.13ohm max.  | -55°C to +125°C             | Kit |
| BLM21AG331SN1□ | 330ohm ±25%                | 700mA         | 0.16ohm max.  | -55°C to +125°C             | Kit |
| BLM21AG471SN1□ | 470ohm ±25%                | 700mA         | 0.19ohm max.  | -55°C to +125°C             | Kit |
| BLM21AG601SN1□ | 600ohm ±25%                | 600mA         | 0.21ohm max.  | -55°C to +125°C             | Kit |
| BLM21AG102SN1□ | 1000ohm ±25%               | 500mA         | 0.28ohm max.  | -55°C to +125°C             | Kit |

Number of Circuits: 1

### Impedance-Frequency Characteristics

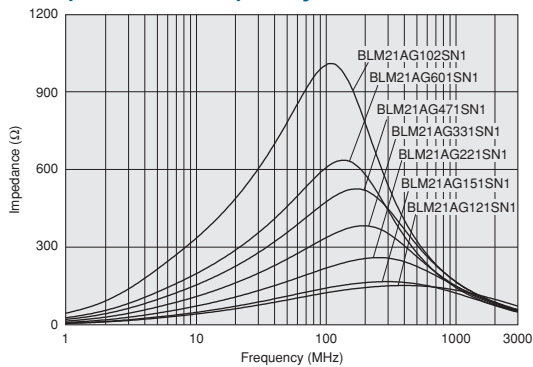

### Impedance-Frequency Characteristics

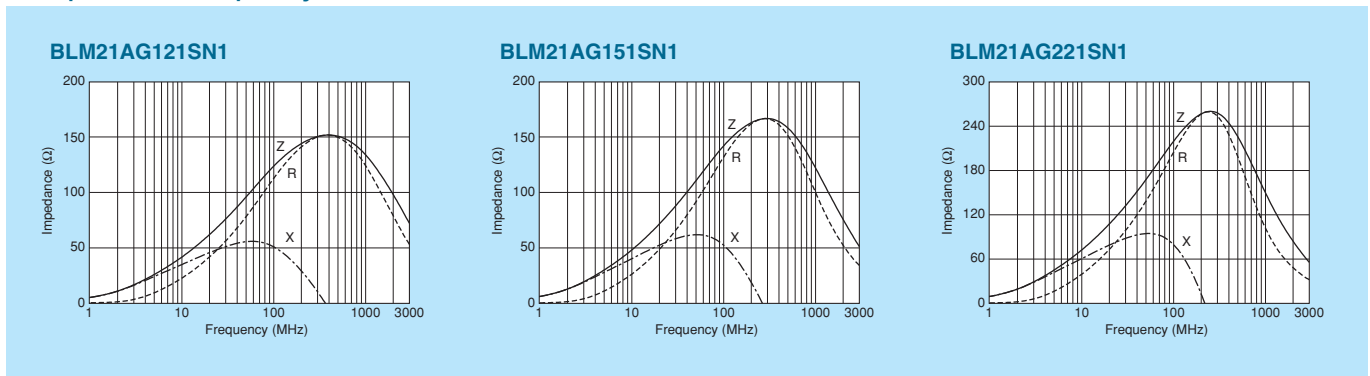

Continued on the following page. ↗

△Note • Please read rating and △CAUTION (for storage, operating, rating, soldering, mounting and handling) in this catalog to prevent smoking and/or burning, etc.  
• This catalog has only typical specifications. Therefore, please approve our product specifications or transact the approval sheet for product specifications before ordering.

Chip EMIFIL®

Chip Common Mode Choke Coil

Block Type EMIFIL®

Microwave Absorber

Impedance-Frequency Characteristics

BLM21AG331SN1

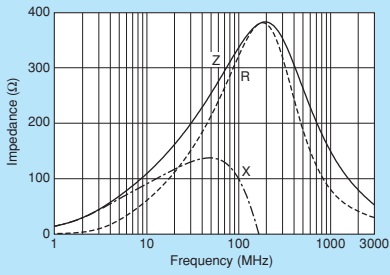

BLM21AG471SN1

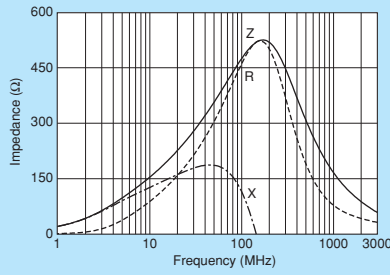

BLM21AG601SN1

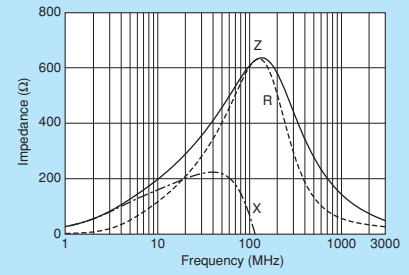

BLM21AG102SN1

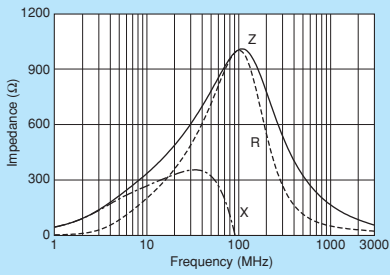

0805/2012 (inch/mm)  
Chip Ferrite Bead

Chip EMIFIL®

Chip Common Mode Choke Coil

Block Type EMIFIL®

Microwave Absorber

⚠Note • Please read rating and ⚠CAUTION (for storage, operating, rating, soldering, mounting and handling) in this catalog to prevent smoking and/or burning, etc.  
 • This catalog has only typical specifications. Therefore, please approve our product specifications or transact the approval sheet for product specifications before ordering.

# BLM21B Series 0805/2012 (inch/mm)



0805 size for high speed signal lines.

Chip Ferrite Bead  
0805/2012 (inch/mm)

Chip EMIFIL®

Chip Common Mode Choke Coil

Block Type EMIFIL®

Microwave Absorber



### ■ Dimensions

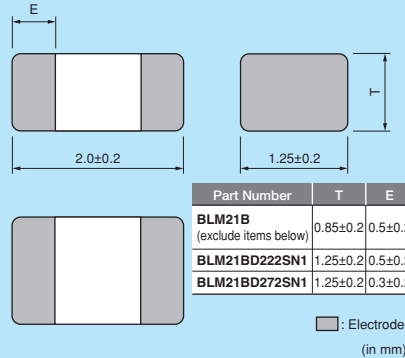

### ■ Equivalent Circuit

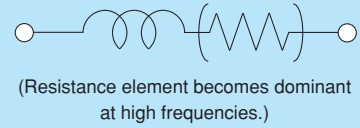

### ■ Packaging

• All except for BLM21BD222SN1/21BD272SN1

| Code | Packaging             | Minimum Quantity |
|------|-----------------------|------------------|
| D    | 180mm Reel Paper Tape | 4000             |
| J    | 330mm Reel Paper Tape | 10000            |
| B    | Bulk(Bag)             | 1000             |

• BLM21BD222SN1/21BD272SN1 only

| Code | Packaging               | Minimum Quantity |
|------|-------------------------|------------------|
| L    | 180mm Reel Plastic Tape | 3000             |
| K    | 330mm Reel Plastic Tape | 10000            |
| B    | Bulk(Bag)               | 1000             |

Refer to pages from p.100 to p.103 for mounting information.

### ■ Rated Value (□: packaging code)

| Part Number    | Impedance (at 100MHz/20°C) | Rated Current | DC Resistance | Operating Temperature Range |     |
|----------------|----------------------------|---------------|---------------|-----------------------------|-----|
| BLM21BD121SN1□ | 120ohm ±25%                | 200mA         | 0.25ohm max.  | -55°C to +125°C             | Kit |
| BLM21BD151SN1□ | 150ohm ±25%                | 200mA         | 0.25ohm max.  | -55°C to +125°C             |     |
| BLM21BD221SN1□ | 220ohm ±25%                | 200mA         | 0.25ohm max.  | -55°C to +125°C             | Kit |
| BLM21BD331SN1□ | 330ohm ±25%                | 200mA         | 0.30ohm max.  | -55°C to +125°C             |     |
| BLM21BD421SN1□ | 420ohm ±25%                | 200mA         | 0.30ohm max.  | -55°C to +125°C             | Kit |
| BLM21BD471SN1□ | 470ohm ±25%                | 200mA         | 0.35ohm max.  | -55°C to +125°C             | Kit |
| BLM21BD601SN1□ | 600ohm ±25%                | 200mA         | 0.35ohm max.  | -55°C to +125°C             | Kit |
| BLM21BD751SN1□ | 750ohm ±25%                | 200mA         | 0.40ohm max.  | -55°C to +125°C             |     |
| BLM21BD102SN1□ | 1000ohm ±25%               | 200mA         | 0.40ohm max.  | -55°C to +125°C             | Kit |
| BLM21BD152SN1□ | 1500ohm ±25%               | 200mA         | 0.45ohm max.  | -55°C to +125°C             | Kit |
| BLM21BD182SN1□ | 1800ohm ±25%               | 200mA         | 0.50ohm max.  | -55°C to +125°C             | Kit |
| BLM21BD222TN1□ | 2200ohm ±25%               | 200mA         | 0.60ohm max.  | -55°C to +125°C             | Kit |
| BLM21BD222SN1□ | 2250ohm (Typ.)             | 200mA         | 0.60ohm max.  | -55°C to +125°C             | Kit |
| BLM21BD272SN1□ | 2700ohm ±25%               | 200mA         | 0.80ohm max.  | -55°C to +125°C             | Kit |
| BLM21BB050SN1□ | 5ohm ±25%                  | 1000mA        | 0.02ohm max.  | -55°C to +125°C             | Kit |
| BLM21BB600SN1□ | 60ohm ±25%                 | 800mA         | 0.13ohm max.  | -55°C to +125°C             | Kit |
| BLM21BB750SN1□ | 75ohm ±25%                 | 700mA         | 0.16ohm max.  | -55°C to +125°C             | Kit |
| BLM21BB121SN1□ | 120ohm ±25%                | 600mA         | 0.19ohm max.  | -55°C to +125°C             | Kit |
| BLM21BB151SN1□ | 150ohm ±25%                | 600mA         | 0.21ohm max.  | -55°C to +125°C             |     |
| BLM21BB201SN1□ | 200ohm ±25%                | 500mA         | 0.26ohm max.  | -55°C to +125°C             |     |
| BLM21BB221SN1□ | 220ohm ±25%                | 500mA         | 0.26ohm max.  | -55°C to +125°C             | Kit |
| BLM21BB331SN1□ | 330ohm ±25%                | 400mA         | 0.33ohm max.  | -55°C to +125°C             | Kit |
| BLM21BB471SN1□ | 470ohm ±25%                | 400mA         | 0.40ohm max.  | -55°C to +125°C             | Kit |

Number of Circuits: 1

Continued on the following page. ↗

△Note • Please read rating and △CAUTION (for storage, operating, rating, soldering, mounting and handling) in this catalog to prevent smoking and/or burning, etc.  
• This catalog has only typical specifications. Therefore, please approve our product specifications or transact the approval sheet for product specifications before ordering.



Impedance-Frequency Characteristics

BLM21BD Series

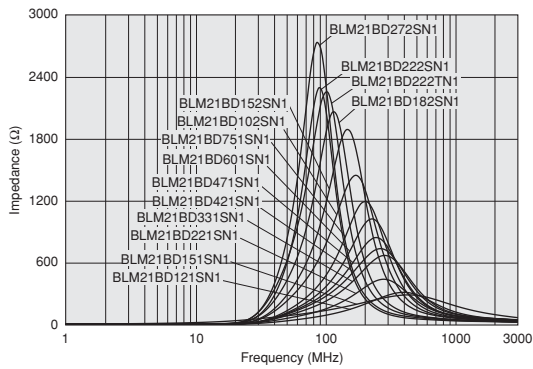

BLM21BB Series

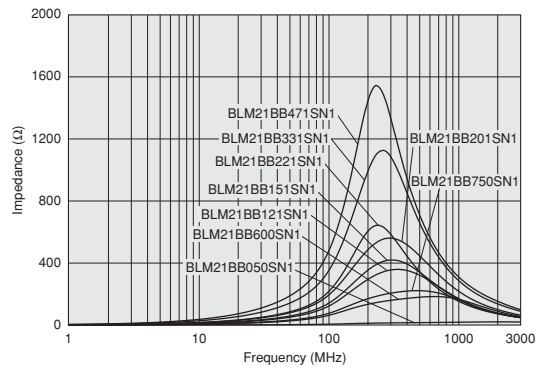

Impedance-Frequency Characteristics

BLM21BD121SN1

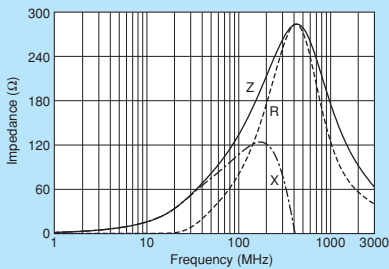

BLM21BD151SN1

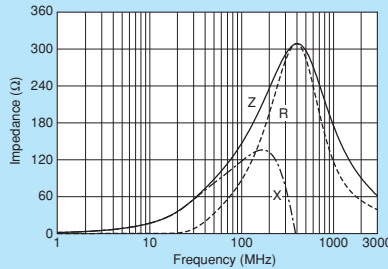

BLM21BD221SN1

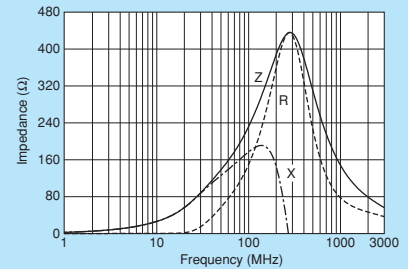

BLM21BD331SN1

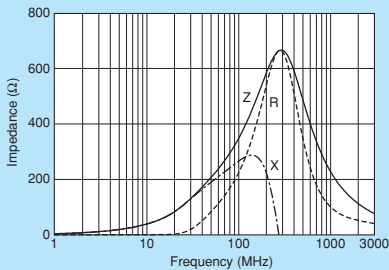

BLM21BD421SN1

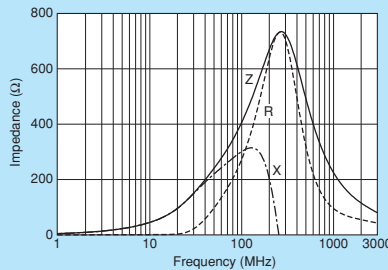

BLM21BD471SN1

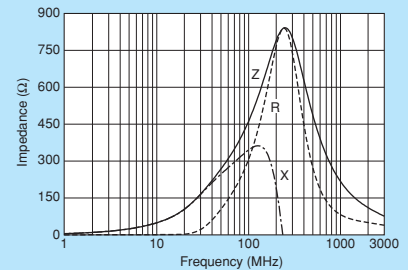

BLM21BD601SN1

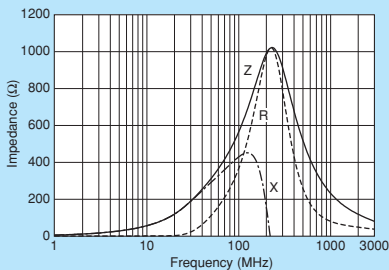

BLM21BD751SN1

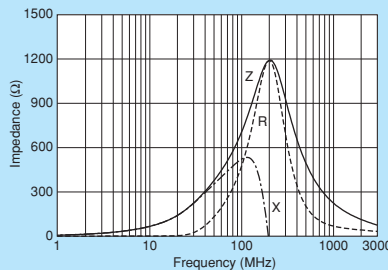

BLM21BD102SN1

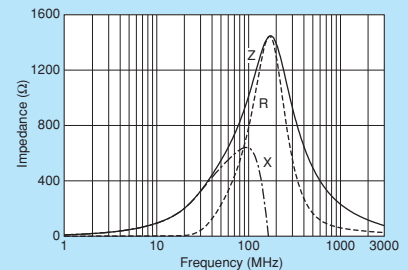

Continued on the following page.

**Note** • Please read rating and **CAUTION** (for storage, operating, rating, soldering, mounting and handling) in this catalog to prevent smoking and/or burning, etc.  
 • This catalog has only typical specifications. Therefore, please approve our product specifications or transact the approval sheet for product specifications before ordering.

Impedance-Frequency Characteristics

Chip Ferrite Bead  
 0805/2012 (inch/mm)

Chip EMIFIL®

Chip Common Mode Choke Coil

Block Type EMIFIL®

Microwave Absorber

BLM21BD152SN1

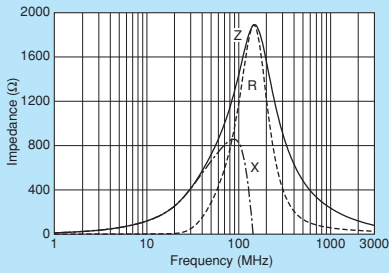

BLM21BD182SN1

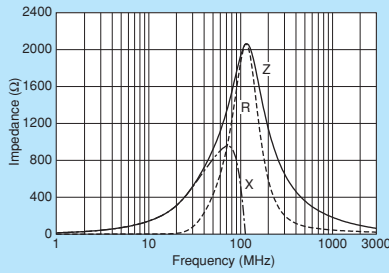

BLM21BD222TN1

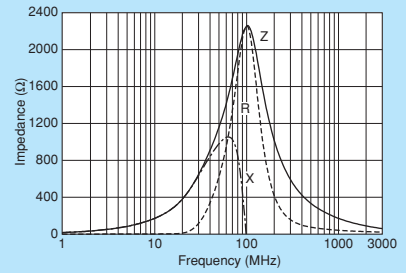

BLM21BD222SN1

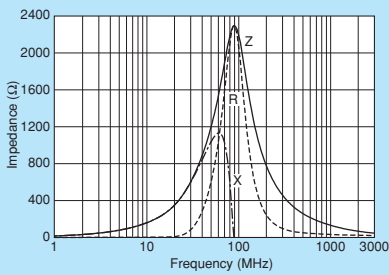

BLM21BD272SN1

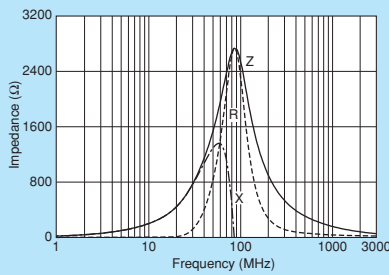

BLM21BB050SN1

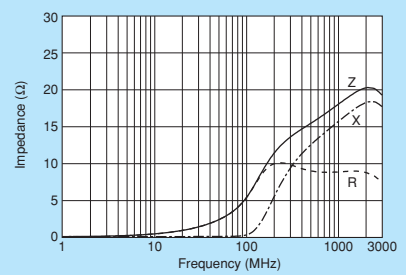

BLM21BB600SN1

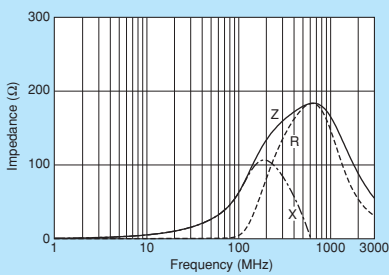

BLM21BB750SN1

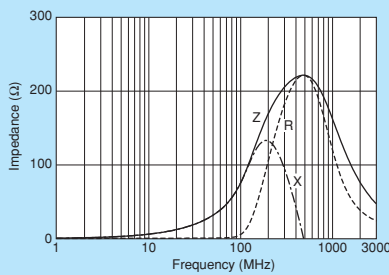

BLM21BB121SN1

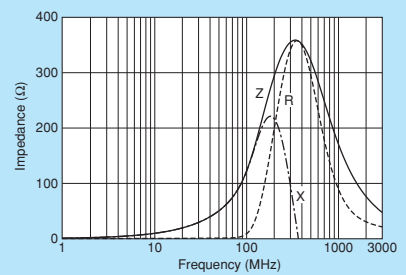

BLM21BB151SN1

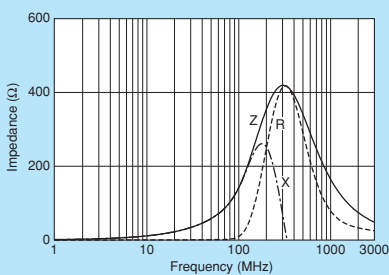

BLM21BB201SN1

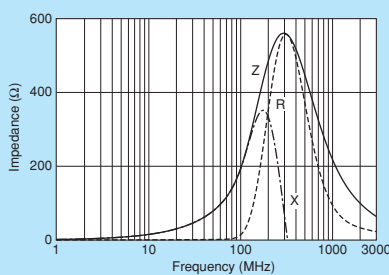

BLM21BB221SN1

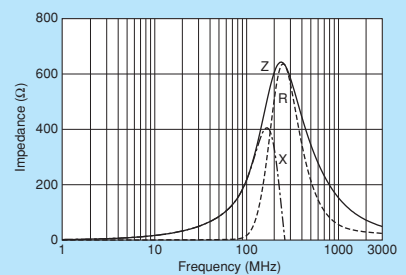

BLM21BB331SN1

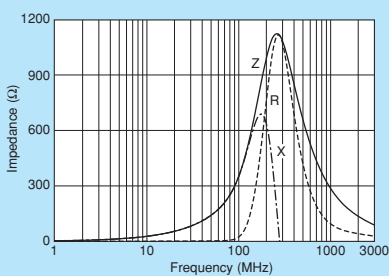

BLM21BB471SN1

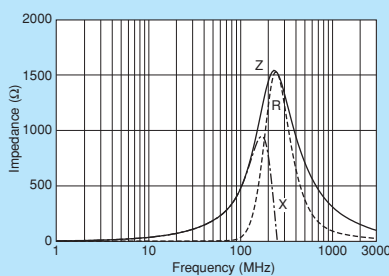

⚠ Note • Please read rating and ⚠ CAUTION (for storage, operating, rating, soldering, mounting and handling) in this catalog to prevent smoking and/or burning, etc.  
 • This catalog has only typical specifications. Therefore, please approve our product specifications or transact the approval sheet for product specifications before ordering.

# BLM21R Series 0805/2012 (inch/mm)



For digital I/F. Reduces the distortion of waveform created by resonance.



### ■ Dimensions

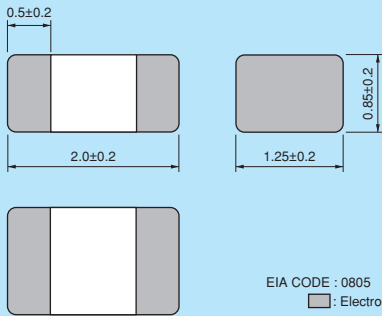

EIA CODE : 0805  
 Electrode  
 (in mm)

### ■ Equivalent Circuit



(Resistance element becomes dominant at high frequencies.)

### ■ Packaging

| Code | Packaging             | Minimum Quantity |
|------|-----------------------|------------------|
| D    | 180mm Reel Paper Tape | 4000             |
| J    | 330mm Reel Paper Tape | 10000            |
| B    | Bulk(Bag)             | 1000             |

Refer to pages from p.100 to p.103 for mounting information.

### ■ Rated Value (□: packaging code)

| Part Number    | Impedance (at 100MHz/20°C) | Rated Current | DC Resistance | Operating Temperature Range |
|----------------|----------------------------|---------------|---------------|-----------------------------|
| BLM21RK121SN1□ | 120ohm ±25%                | 200mA         | 0.15ohm max.  | -55°C to +125°C             |
| BLM21RK221SN1□ | 220ohm ±25%                | 200mA         | 0.20ohm max.  | -55°C to +125°C             |
| BLM21RK471SN1□ | 470ohm ±25%                | 200mA         | 0.25ohm max.  | -55°C to +125°C             |
| BLM21RK601SN1□ | 600ohm ±25%                | 200mA         | 0.30ohm max.  | -55°C to +125°C             |
| BLM21RK102SN1□ | 1000ohm ±25%               | 200mA         | 0.50ohm max.  | -55°C to +125°C             |

Number of Circuits: 1

### ■ Impedance-Frequency Characteristics

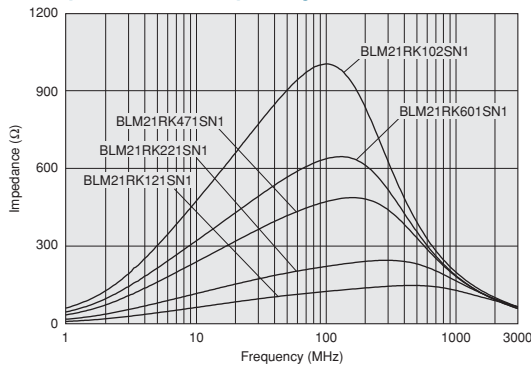

### ■ Impedance-Frequency Characteristics

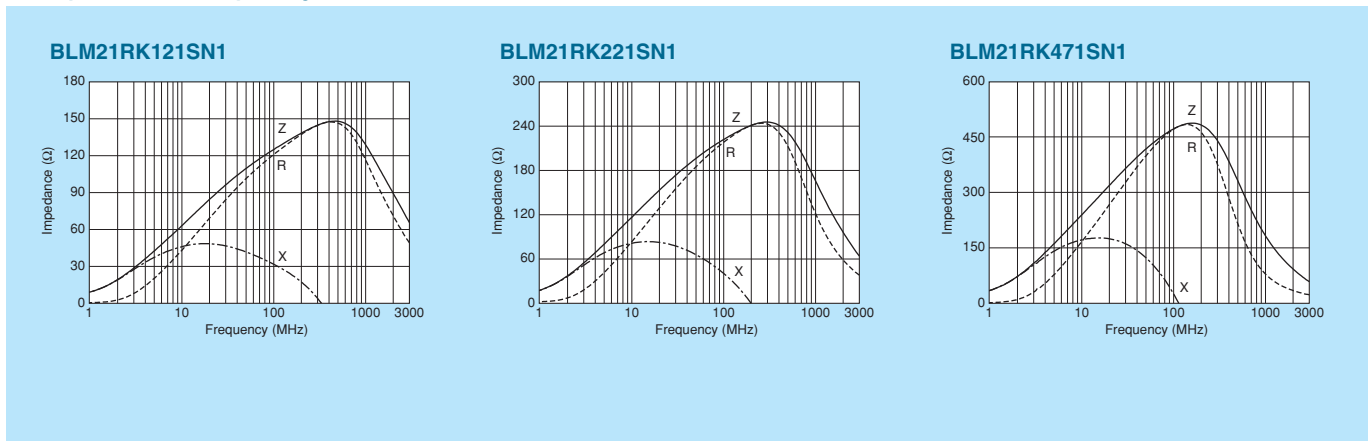

Continued on the following page.

⚠Note • Please read rating and ⚠CAUTION (for storage, operating, rating, soldering, mounting and handling) in this catalog to prevent smoking and/or burning, etc.  
 • This catalog has only typical specifications. Therefore, please approve our product specifications or transact the approval sheet for product specifications before ordering.

■ Impedance-Frequency Characteristics

BLM21RK601SN1

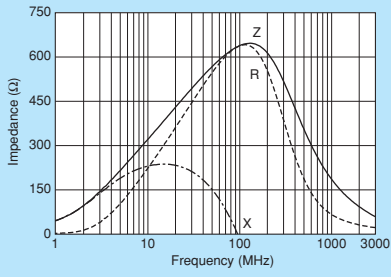

BLM21RK102SN1

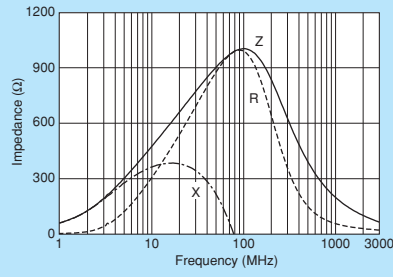

Chip Ferrite Bead  
0805/2012 (inch/mm)

Chip EMIFIL®

Chip Common Mode Choke Coil

Block Type EMIFIL®

Microwave Absorber

△Note • Please read rating and △CAUTION (for storage, operating, rating, soldering, mounting and handling) in this catalog to prevent smoking and/or burning, etc.  
 • This catalog has only typical specifications. Therefore, please approve our product specifications or transact the approval sheet for product specifications before ordering.

# BLM31P Series 1206/3216 (inch/mm)



## 1206 size for power lines.

\*Please refer to the products designed for both power lines and signal lines.



### ■ Dimensions

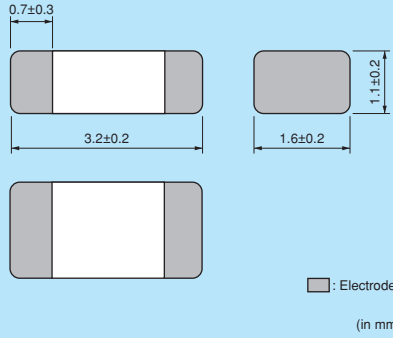

(in mm)

### ■ Equivalent Circuit



(Resistance element becomes dominant at high frequencies.)

### ■ Packaging

| Code | Packaging                | Minimum Quantity |
|------|--------------------------|------------------|
| L    | 180mm Reel Embossed Tape | 3000             |
| K    | 330mm Reel Embossed Tape | 10000            |
| B    | Bulk(Bag)                | 1000             |

Refer to pages from p.100 to p.103 for mounting information.

### ■ Rated Value (□: packaging code)

| Part Number    | Impedance (at 100MHz/20°C) | Rated Current | DC Resistance | Operating Temperature Range | Kit | Current |
|----------------|----------------------------|---------------|---------------|-----------------------------|-----|---------|
| BLM31PG330SN1□ | 33ohm ±25%                 | 6000mA        | 0.009ohm max. | -55°C to +125°C             | Kit | ≥3A     |
| BLM31PG500SN1□ | 50ohm (Typ.)               | 3500mA        | 0.015ohm max. | -55°C to +125°C             | Kit | ≥3A     |
| BLM31PG121SN1□ | 120ohm ±25%                | 3500mA        | 0.02ohm max.  | -55°C to +125°C             | Kit | ≥3A     |
| BLM31PG391SN1□ | 390ohm ±25%                | 2000mA        | 0.05ohm max.  | -55°C to +125°C             | Kit | ≥1A     |
| BLM31PG601SN1□ | 600ohm ±25%                | 1500mA        | 0.08ohm max.  | -55°C to +125°C             | Kit | ≥1A     |

Number of Circuits: 1

### ■ Impedance-Frequency Characteristics

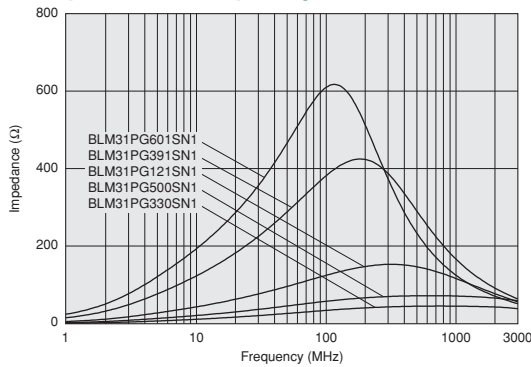

### ■ Notice (Rating)

In operating temperature exceeding +85°C, derating of current is necessary for BLM31PG series.

Please apply the derating curve shown in chart according to the operating temperature.

Derating of Rated Current

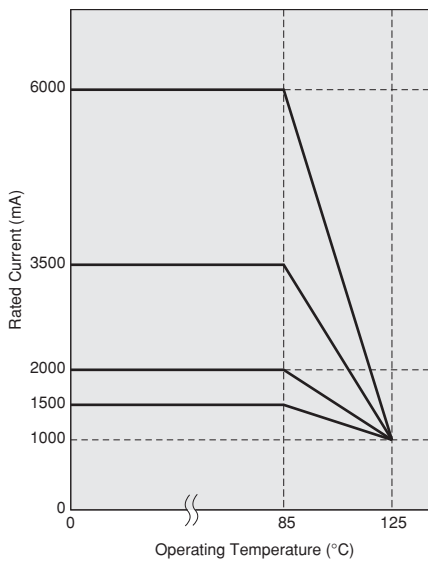

Continued on the following page.

⚠Note • Please read rating and ⚠CAUTION (for storage, operating, rating, soldering, mounting and handling) in this catalog to prevent smoking and/or burning, etc.  
• This catalog has only typical specifications. Therefore, please approve our product specifications or transact the approval sheet for product specifications before ordering.

Impedance-Frequency Characteristics

BLM31PG330SN1

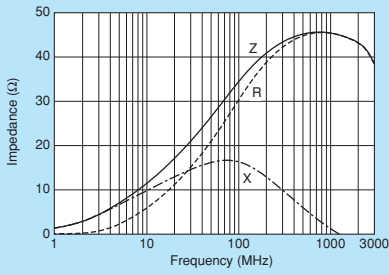

BLM31PG500SN1

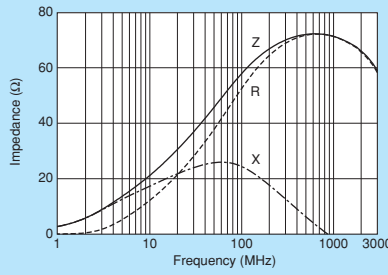

BLM31PG121SN1

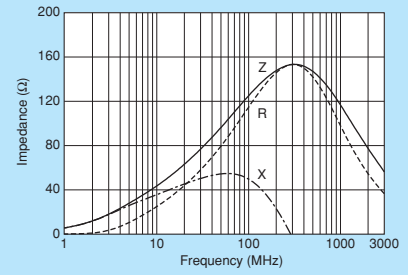

BLM31PG391SN1

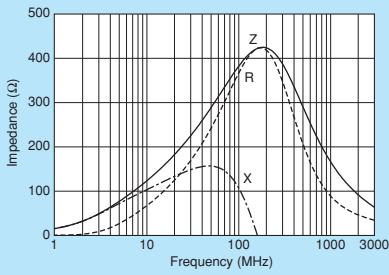

BLM31PG601SN1

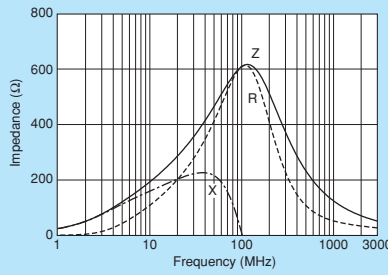

⚠Note • Please read rating and ⚠CAUTION (for storage, operating, rating, soldering, mounting and handling) in this catalog to prevent smoking and/or burning, etc.  
 • This catalog has only typical specifications. Therefore, please approve our product specifications or transact the approval sheet for product specifications before ordering.

Chip Ferrite Bead  
 1206/3216 (inch/mm)

Chip EMIFIL®

Chip Common Mode Choke Coil

Block Type EMIFIL®

Microwave Absorber

# BLM41P Series 1806/4516 (inch/mm)



## 1806 size for power lines.

\*Please refer to the products designed for both power lines and signal lines.

### ■ Dimensions

(in mm)

### ■ Equivalent Circuit

(Resistance element becomes dominant at high frequencies.)

### ■ Packaging

| Code | Packaging                | Minimum Quantity |
|------|--------------------------|------------------|
| L    | 180mm Reel Embossed Tape | 2500             |
| K    | 330mm Reel Embossed Tape | 8000             |
| B    | Bulk(Bag)                | 1000             |

Refer to pages from p.100 to p.103 for mounting information.

### ■ Rated Value (□: packaging code)

| Part Number    | Impedance (at 100MHz/20°C) | Rated Current | DC Resistance | Operating Temperature Range | Kit | Current |
|----------------|----------------------------|---------------|---------------|-----------------------------|-----|---------|
| BLM41PG600SN1□ | 60ohm (Typ.)               | 6000mA        | 0.009ohm max. | -55°C to +125°C             | Kit | ≥3A     |
| BLM41PG750SN1□ | 75ohm (Typ.)               | 3500mA        | 0.015ohm max. | -55°C to +125°C             | Kit | ≥3A     |
| BLM41PG181SN1□ | 180ohm ±25%                | 3500mA        | 0.02ohm max.  | -55°C to +125°C             | Kit | ≥3A     |
| BLM41PG471SN1□ | 470ohm ±25%                | 2000mA        | 0.05ohm max.  | -55°C to +125°C             | Kit | ≥1A     |
| BLM41PG102SN1□ | 1000ohm ±25%               | 1500mA        | 0.09ohm max.  | -55°C to +125°C             | Kit | ≥1A     |

Number of Circuits: 1

### ■ Impedance-Frequency Characteristics BLM41PG Series (60ohm to 75ohm)

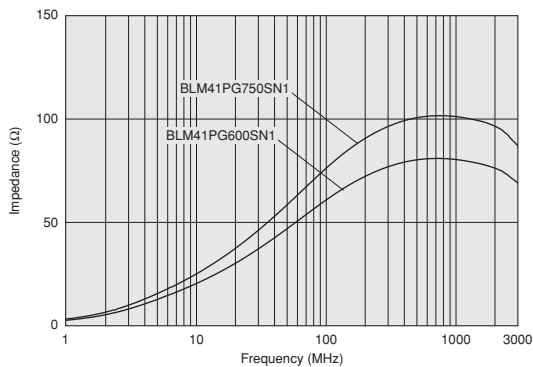

### ■ Impedance-Frequency Characteristics BLM41PG Series (180ohm to 1000ohm)

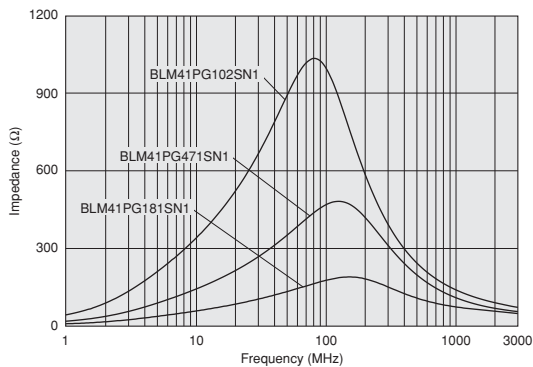

### ■ Notice (Rating)

In operating temperature exceeding +85°C, derating of current is necessary for BLM41PG series.

Please apply the derating curve shown in chart according to the operating temperature.

Derating of Rated Current

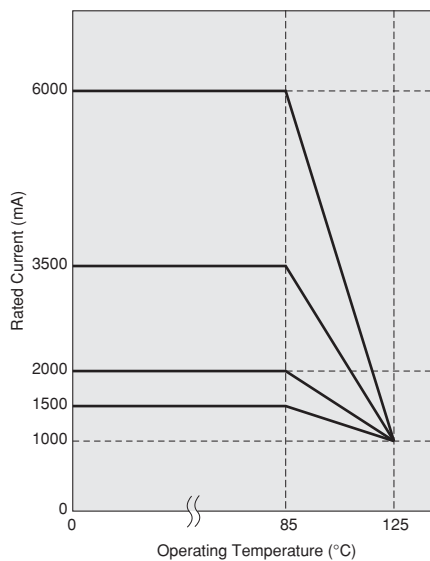

Continued on the following page.

⚠Note • Please read rating and ⚠CAUTION (for storage, operating, rating, soldering, mounting and handling) in this catalog to prevent smoking and/or burning, etc.  
• This catalog has only typical specifications. Therefore, please approve our product specifications or transact the approval sheet for product specifications before ordering.

Impedance-Frequency Characteristics

Chip Ferrite Bead  
 1806/4516 (inch/mm)

Chip EMIFIL®

Chip Common Mode Choke Coil

Block Type EMIFIL®

Microwave Absorber

BLM41PG600SN1

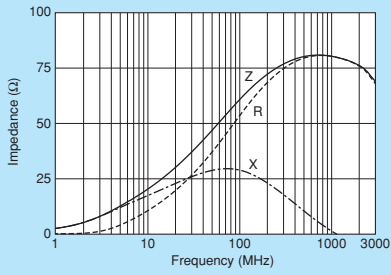

BLM41PG750SN1

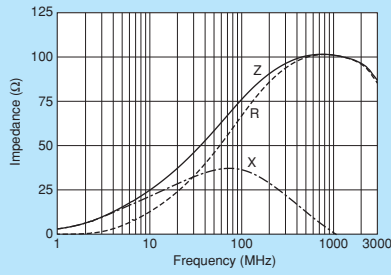

BLM41PG181SN1

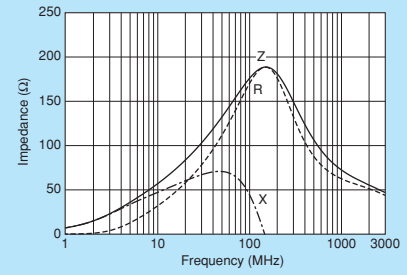

BLM41PG471SN1

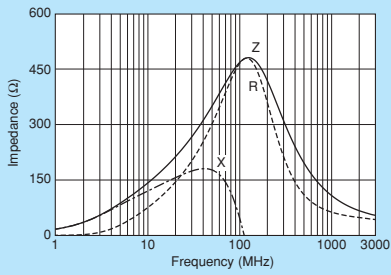

BLM41PG102SN1

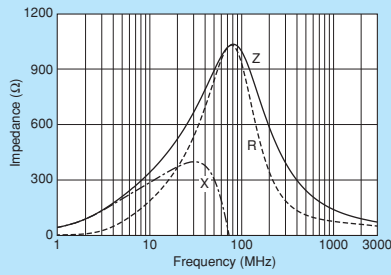

⚠Note • Please read rating and ⚠CAUTION (for storage, operating, rating, soldering, mounting and handling) in this catalog to prevent smoking and/or burning, etc.  
 • This catalog has only typical specifications. Therefore, please approve our product specifications or transact the approval sheet for product specifications before ordering.



# BLE32P Series 1210/3225 (inch/mm)



10A max., large current chip ferrite bead inductor.

### ■ Dimensions

3.2±0.2 (Length)  
2.5±0.2 (Width)  
2.0±0.2 (Height)  
0.7±0.3 (Electrode thickness)

Legend:  Electrode (in mm)

### ■ Equivalent Circuit

(Resistance element becomes dominant at high frequencies.)

### ■ Packaging

| Code | Packaging                | Minimum Quantity |
|------|--------------------------|------------------|
| L    | 180mm Reel Embossed Tape | 1500             |
| K    | 330mm Reel Embossed Tape | 7000             |
| B    | Bulk(Bag)                | 1000             |

Refer to pages from p.100 to p.103 for mounting information.

### ■ Rated Value (□: packaging code)

| Part Number            | Impedance (at 100MHz/20°C) | Rated Current | DC Resistance | Operating Temperature Range |                |
|------------------------|----------------------------|---------------|---------------|-----------------------------|----------------|
| <b>BLE32PN300SN1</b> □ | 30ohm ±10ohm               | 10000mA       | 1.6m ohm max. | -55°C to +125°C             | New $\geq 10A$ |

Number of Circuits: 1

### ■ Impedance-Frequency Characteristics

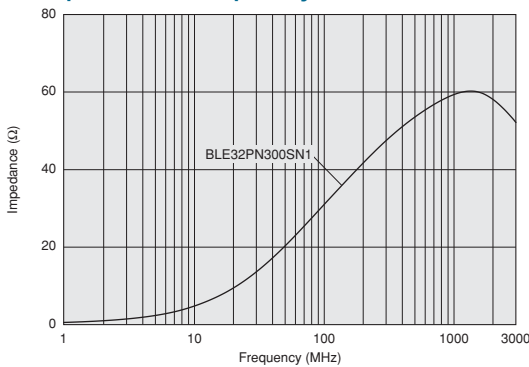

### ■ Impedance-Frequency Characteristics

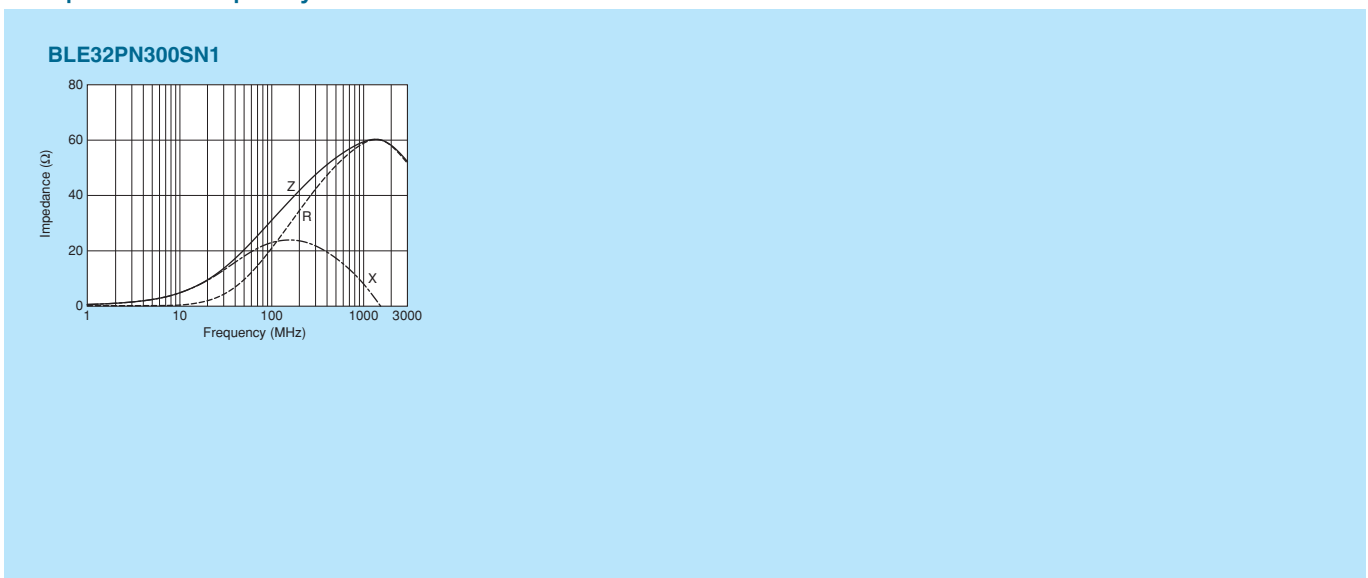

△Note • Please read rating and △CAUTION (for storage, operating, rating, soldering, mounting and handling) in this catalog to prevent smoking and/or burning, etc.  
• This catalog has only typical specifications. Therefore, please approve our product specifications or transact the approval sheet for product specifications before ordering.

# BLA2AA/BLA2AB Series 0804/2010 (inch/mm)



4-line array, 0804 size.

Chip Ferrite Bead  
0804/2010 (inch/mm)

Chip EMIFIL®

Chip Common Mode Choke Coil

Block Type EMIFIL®

Microwave Absorber



### Dimensions

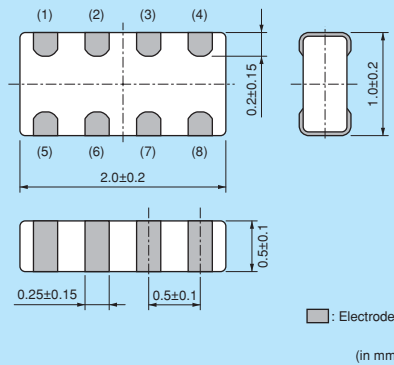

### Equivalent Circuit

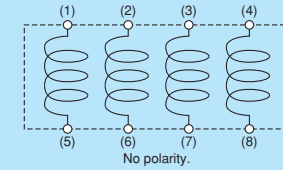

### Packaging

| Code | Packaging             | Minimum Quantity |
|------|-----------------------|------------------|
| D    | 180mm Reel Paper Tape | 10000            |
| J    | 330mm Reel Paper Tape | 50000            |
| B    | Bulk(Bag)             | 1000             |

Refer to pages from p.100 to p.103 for mounting information.

### Rated Value (□: packaging code)

| Part Number    | Impedance (at 100MHz/20°C) | Rated Current | DC Resistance | Operating Temperature Range |
|----------------|----------------------------|---------------|---------------|-----------------------------|
| BLA2AAG121SN4□ | 120ohm ±25%                | 100mA         | 0.50ohm max.  | -55°C to +125°C             |
| BLA2AAG221SN4□ | 220ohm ±25%                | 50mA          | 0.70ohm max.  | -55°C to +125°C             |
| BLA2AAG601SN4□ | 600ohm ±25%                | 50mA          | 1.10ohm max.  | -55°C to +125°C             |
| BLA2AAG102SN4□ | 1000ohm ±25%               | 50mA          | 1.30ohm max.  | -55°C to +125°C             |
| BLA2ABD750SN4□ | 75ohm ±25%                 | 200mA         | 0.20ohm max.  | -55°C to +125°C             |
| BLA2ABD121SN4□ | 120ohm ±25%                | 200mA         | 0.35ohm max.  | -55°C to +125°C             |
| BLA2ABD221SN4□ | 220ohm ±25%                | 100mA         | 0.40ohm max.  | -55°C to +125°C             |
| BLA2ABD471SN4□ | 470ohm ±25%                | 100mA         | 0.65ohm max.  | -55°C to +125°C             |
| BLA2ABD601SN4□ | 600ohm ±25%                | 100mA         | 0.80ohm max.  | -55°C to +125°C             |
| BLA2ABD102SN4□ | 1000ohm ±25%               | 50mA          | 1.00ohm max.  | -55°C to +125°C             |
| BLA2ABB100SN4□ | 10ohm ±25%                 | 200mA         | 0.1ohm max.   | -55°C to +125°C             |
| BLA2ABB220SN4□ | 22ohm ±25%                 | 200mA         | 0.2ohm max.   | -55°C to +125°C             |
| BLA2ABB470SN4□ | 47ohm ±25%                 | 200mA         | 0.35ohm max.  | -55°C to +125°C             |
| BLA2ABB121SN4□ | 120ohm ±25%                | 50mA          | 0.60ohm max.  | -55°C to +125°C             |
| BLA2ABB221SN4□ | 220ohm ±25%                | 50mA          | 0.90ohm max.  | -55°C to +125°C             |

Number of Circuits: 4

### Impedance-Frequency Characteristics

#### BLA2AAG Series

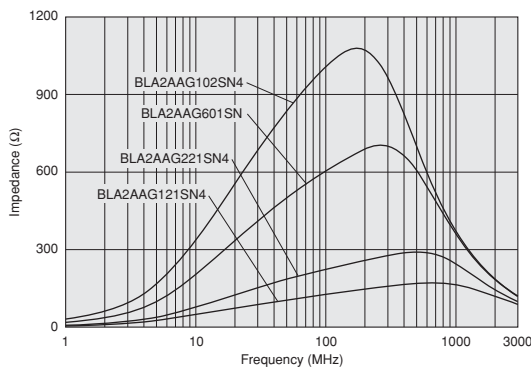

#### BLA2ABD Series

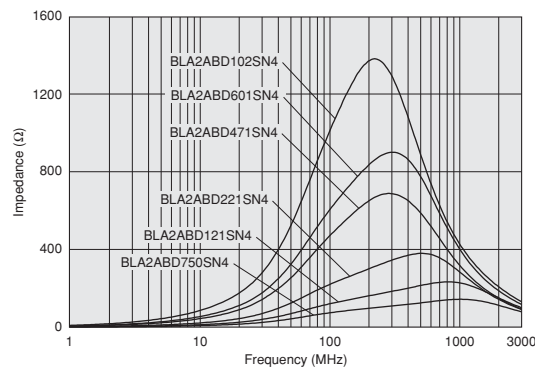

Continued on the following page. ↗

⚠Note • Please read rating and ⚠CAUTION (for storage, operating, rating, soldering, mounting and handling) in this catalog to prevent smoking and/or burning, etc.  
• This catalog has only typical specifications. Therefore, please approve our product specifications or transact the approval sheet for product specifications before ordering.

**Impedance-Frequency Characteristics**  
 BLA2ABB Series

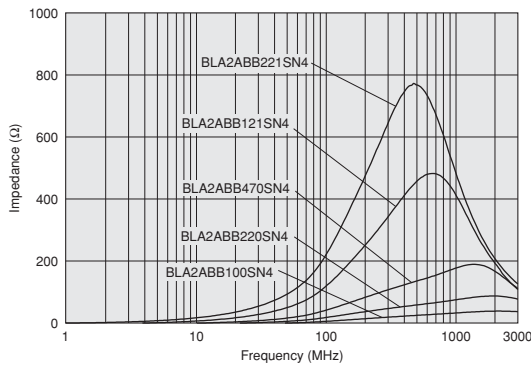

**Impedance-Frequency Characteristics**

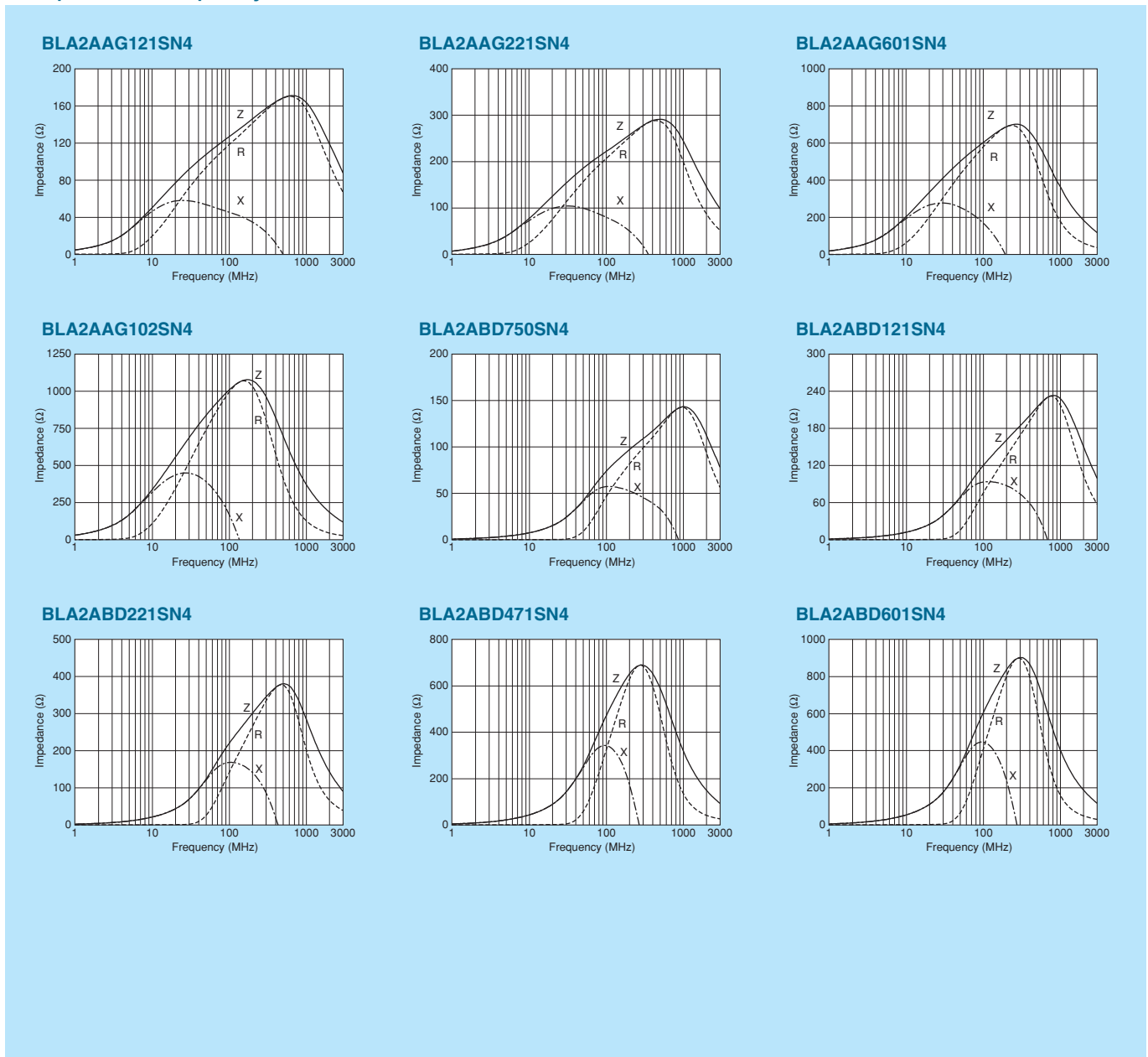

Continued on the following page.

**Note** • Please read rating and **CAUTION** (for storage, operating, rating, soldering, mounting and handling) in this catalog to prevent smoking and/or burning, etc.  
 • This catalog has only typical specifications. Therefore, please approve our product specifications or transact the approval sheet for product specifications before ordering.

Impedance-Frequency Characteristics

BLA2ABD102SN4

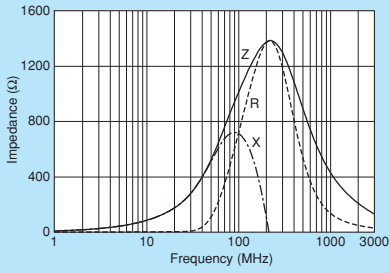

BLA2ABB100SN4

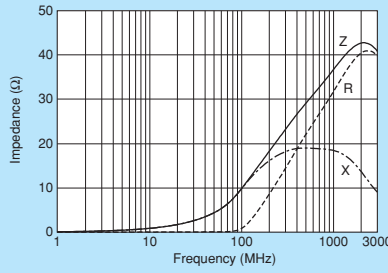

BLA2ABB220SN4

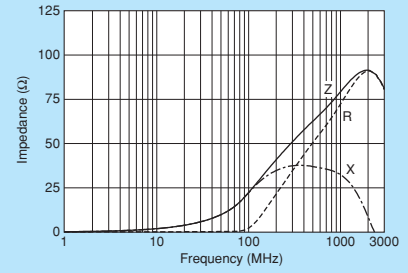

BLA2ABB470SN4

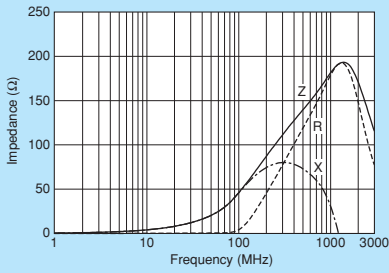

BLA2ABB121SN4

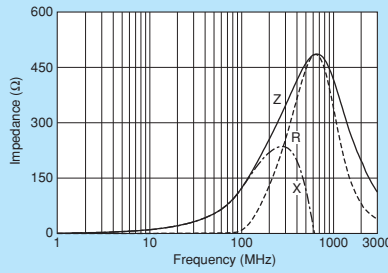

BLA2ABB221SN4

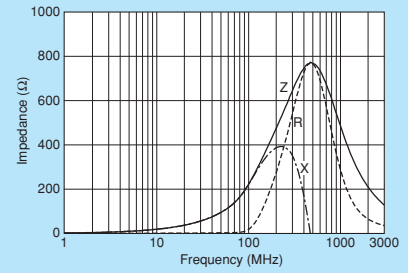

⚠Note • Please read rating and ⚠CAUTION (for storage, operating, rating, soldering, mounting and handling) in this catalog to prevent smoking and/or burning, etc.  
 • This catalog has only typical specifications. Therefore, please approve our product specifications or transact the approval sheet for product specifications before ordering.

Chip Ferrite Bead  
 0804/2010 (inch/mm)

Chip EMIFIL®

Chip Common Mode Choke Coil

Block Type EMIFIL®

Microwave Absorber

# BLA31A/BLA31B Series 1206/3216 (inch/mm)



4-line array, 1206 size.

### ■ Dimensions

(in mm)

### ■ Equivalent Circuit

No polarity.

### ■ Packaging

| Code | Packaging             | Minimum Quantity |
|------|-----------------------|------------------|
| D    | 180mm Reel Paper Tape | 4000             |
| J    | 330mm Reel Paper Tape | 10000            |
| B    | Bulk(Bag)             | 1000             |

Refer to pages from p.100 to p.103 for mounting information.

### ■ Rated Value (□: packaging code)

| Part Number    | Impedance (at 100MHz/20°C) | Rated Current | DC Resistance | Operating Temperature Range |
|----------------|----------------------------|---------------|---------------|-----------------------------|
| BLA31AG300SN4□ | 30ohm ±25%                 | 200mA         | 0.10ohm max.  | -55°C to +125°C             |
| BLA31AG600SN4□ | 60ohm ±25%                 | 200mA         | 0.15ohm max.  | -55°C to +125°C             |
| BLA31AG121SN4□ | 120ohm ±25%                | 150mA         | 0.20ohm max.  | -55°C to +125°C             |
| BLA31AG221SN4□ | 220ohm ±25%                | 150mA         | 0.25ohm max.  | -55°C to +125°C             |
| BLA31AG601SN4□ | 600ohm ±25%                | 100mA         | 0.35ohm max.  | -55°C to +125°C             |
| BLA31AG102SN4□ | 1000ohm ±25%               | 50mA          | 0.45ohm max.  | -55°C to +125°C             |
| BLA31BD121SN4□ | 120ohm ±25%                | 150mA         | 0.30ohm max.  | -55°C to +125°C             |
| BLA31BD221SN4□ | 220ohm ±25%                | 150mA         | 0.35ohm max.  | -55°C to +125°C             |
| BLA31BD471SN4□ | 470ohm ±25%                | 100mA         | 0.40ohm max.  | -55°C to +125°C             |
| BLA31BD601SN4□ | 600ohm ±25%                | 100mA         | 0.45ohm max.  | -55°C to +125°C             |
| BLA31BD102SN4□ | 1000ohm ±25%               | 50mA          | 0.55ohm max.  | -55°C to +125°C             |

Number of Circuits: 4

### ■ Impedance-Frequency Characteristics

#### BLA31AG Series

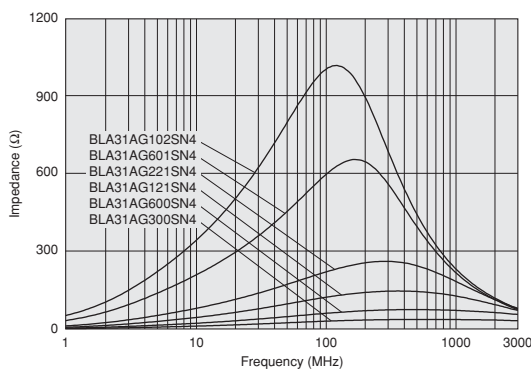

#### BLA31BD Series

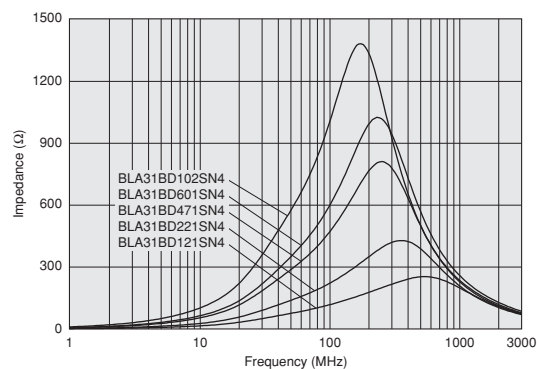

Continued on the following page.

⚠Note • Please read rating and ⚠CAUTION (for storage, operating, rating, soldering, mounting and handling) in this catalog to prevent smoking and/or burning, etc.  
 • This catalog has only typical specifications. Therefore, please approve our product specifications or transact the approval sheet for product specifications before ordering.

Impedance-Frequency Characteristics

Chip Ferrite Bead  
 1206/3216 (inch/mm)

Chip EMIFIL®

Chip Common Mode Choke Coil

Block Type EMIFIL®

Microwave Absorber

BLA31AG300SN4

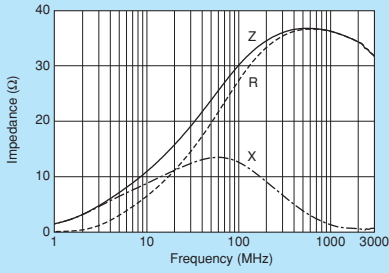

BLA31AG600SN4

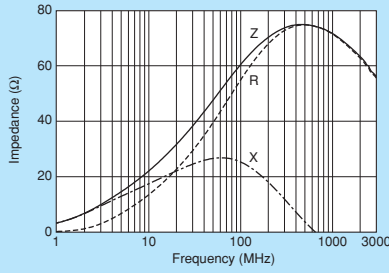

BLA31AG121SN4

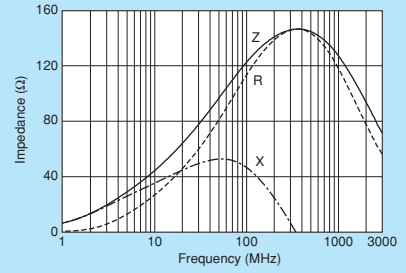

BLA31AG221SN4

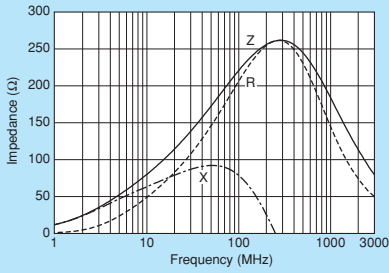

BLA31AG601SN4

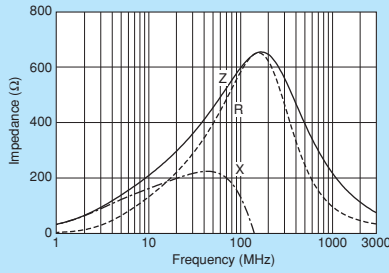

BLA31AG102SN4

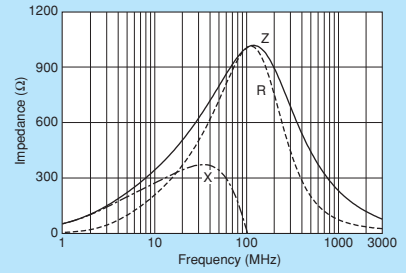

BLA31BD121SN4

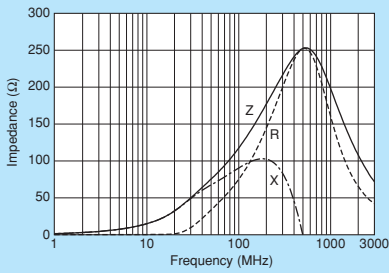

BLA31BD221SN4

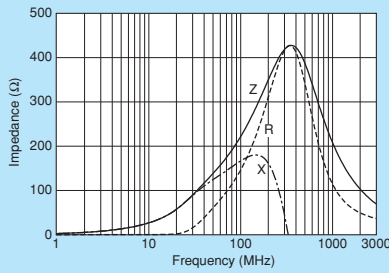

BLA31BD471SN4

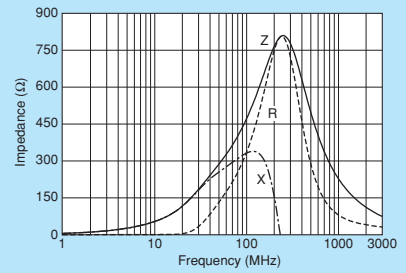

BLA31BD601SN4

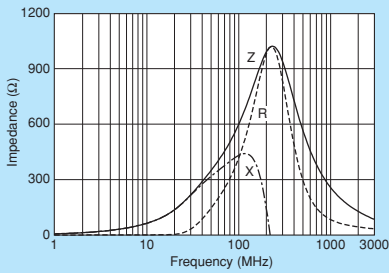

BLA31BD102SN4

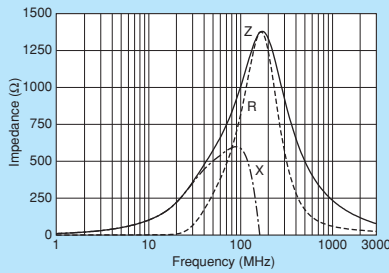

⚠ Note • Please read rating and ⚠ CAUTION (for storage, operating, rating, soldering, mounting and handling) in this catalog to prevent smoking and/or burning, etc.  
 • This catalog has only typical specifications. Therefore, please approve our product specifications or transact the approval sheet for product specifications before ordering.

# BLM03H Series 0201/0603 (inch/mm)



0201 size for GHz band noise.

### ■ Dimensions

### ■ Equivalent Circuit

(Resistance element becomes dominant at high frequencies.)

### ■ Packaging

| Code | Packaging             | Minimum Quantity |
|------|-----------------------|------------------|
| D    | 180mm Reel Paper Tape | 15000            |
| J    | 330mm Reel Paper Tape | 50000            |
| B    | Bulk(Bag)             | 1000             |

Refer to pages from p.100 to p.103 for mounting information.

### ■ Rated Value (□: packaging code)

| Part Number    | Impedance (at 100MHz/20°C) | Impedance (at 1GHz/20°C) | Rated Current | DC Resistance | Operating Temperature Range |     |
|----------------|----------------------------|--------------------------|---------------|---------------|-----------------------------|-----|
| BLM03HG601SN1□ | 600ohm ±25%                | 1000ohm ±40%             | 150mA         | 1.6ohm max.   | -55°C to +125°C             | Kit |
| BLM03HG102SN1□ | 1000ohm ±25%               | 1800ohm ±40%             | 125mA         | 2.6ohm max.   | -55°C to +125°C             | Kit |
| BLM03HG122SN1□ | 1200ohm ±25%               | 2000ohm ±40%             | 100mA         | 3.5ohm max.   | -55°C to +125°C             | New |
| BLM03HD331SN1□ | 330ohm ±25%                | 750ohm ±40%              | 200mA         | 1.0ohm max.   | -55°C to +125°C             | Kit |
| BLM03HD471SN1□ | 470ohm ±25%                | 1000ohm ±40%             | 175mA         | 1.3ohm max.   | -55°C to +125°C             | Kit |
| BLM03HD601SN1□ | 600ohm ±25%                | 1500ohm ±40%             | 150mA         | 1.7ohm max.   | -55°C to +125°C             | Kit |
| BLM03HD102SN1□ | 1000ohm ±25%               | 2300ohm ±40%             | 120mA         | 2.9ohm max.   | -55°C to +125°C             | Kit |
| BLM03HB191SN1□ | 190ohm ±25%                | 1150ohm ±40%             | 150mA         | 2.0ohm max.   | -55°C to +125°C             | Kit |

Number of Circuits: 1

### ■ Impedance-Frequency Characteristics

#### BLM03HG Series

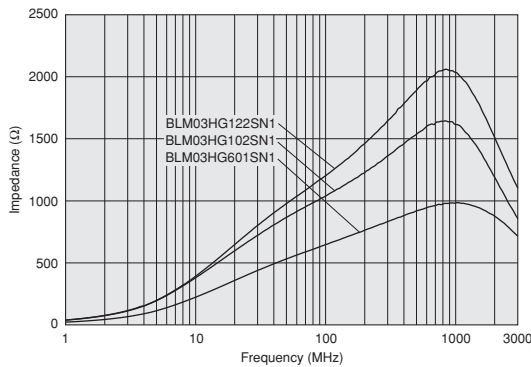

#### BLM03HD Series

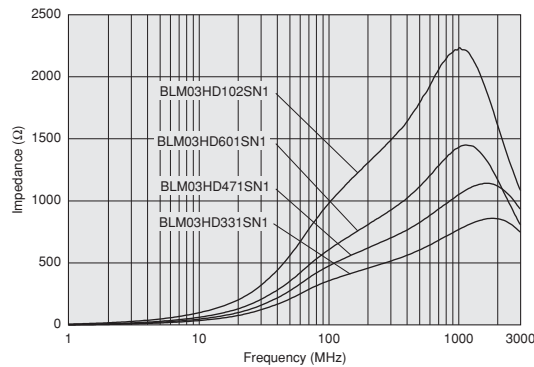

#### BLM03HB Series

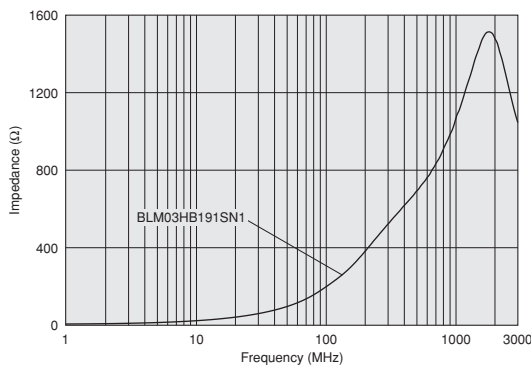

Continued on the following page.

⚠Note • Please read rating and ⚠CAUTION (for storage, operating, rating, soldering, mounting and handling) in this catalog to prevent smoking and/or burning, etc.  
• This catalog has only typical specifications. Therefore, please approve our product specifications or transact the approval sheet for product specifications before ordering.

Impedance-Frequency Characteristics

Chip Ferrite Bead  
 0201/0603 (inch/mm)

Chip EMIFIL®

Chip Common Mode Choke Coil

Block Type EMIFIL®

Microwave Absorber

BLM03HG601SN1

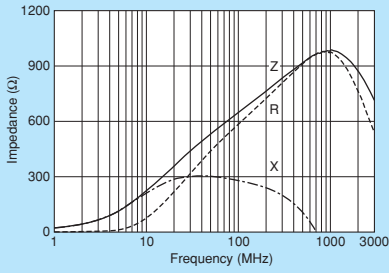

BLM03HG102SN1

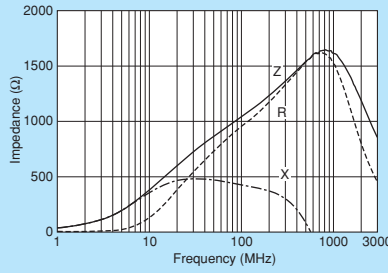

BLM03HG122SN1

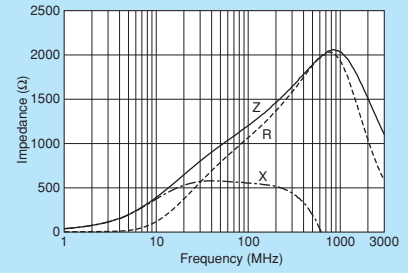

BLM03HD331SN1

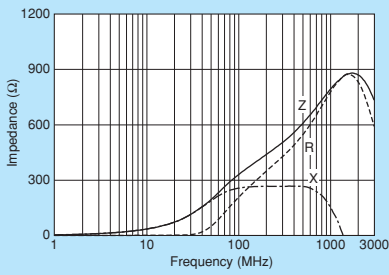

BLM03HD471SN1

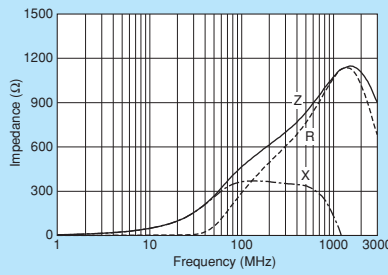

BLM03HD601SN1

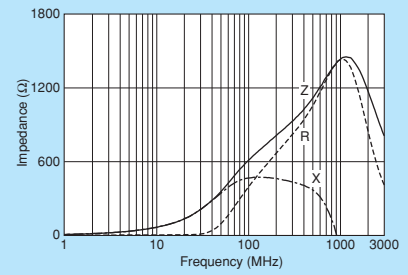

BLM03HD102SN1

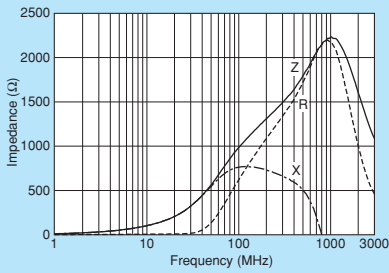

BLM03HB191SN1

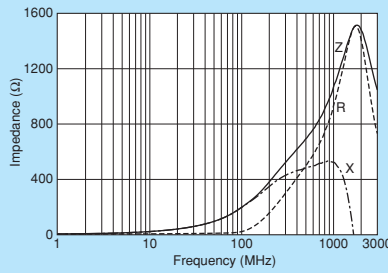

⚠ Note • Please read rating and ⚠ CAUTION (for storage, operating, rating, soldering, mounting and handling) in this catalog to prevent smoking and/or burning, etc.  
 • This catalog has only typical specifications. Therefore, please approve our product specifications or transact the approval sheet for product specifications before ordering.



# BLM03E Series 0201/0603 (inch/mm)



For GHz band noise and capable of large current.



### ■ Dimensions

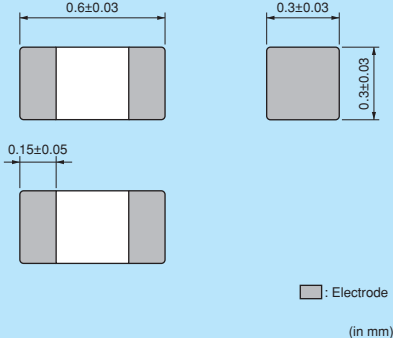

■ : Electrode  
(in mm)

### ■ Equivalent Circuit



(Resistance element becomes dominant at high frequencies.)

### ■ Packaging

| Code | Packaging             | Minimum Quantity |
|------|-----------------------|------------------|
| D    | 180mm Reel Paper Tape | 15000            |
| J    | 330mm Reel Paper Tape | 50000            |
| B    | Bulk(Bag)             | 1000             |

Refer to pages from p.100 to p.103 for mounting information.

### ■ Rated Value (□: packaging code)

| Part Number     | Impedance (at 100MHz/20°C) | Impedance (at 1GHz/20°C) | Rated Current | DC Resistance | Operating Temperature Range |     |
|-----------------|----------------------------|--------------------------|---------------|---------------|-----------------------------|-----|
| BLM03EB250SN1 □ | 25ohm ±25%                 | 105ohm ±40%              | 600mA         | 0.26ohm max.  | -55°C to +125°C             | Kit |
| BLM03EB500SN1 □ | 50ohm ±25%                 | 255ohm ±40%              | 400mA         | 0.58ohm max.  | -55°C to +125°C             | Kit |

Number of Circuits: 1

### ■ Impedance-Frequency Characteristics

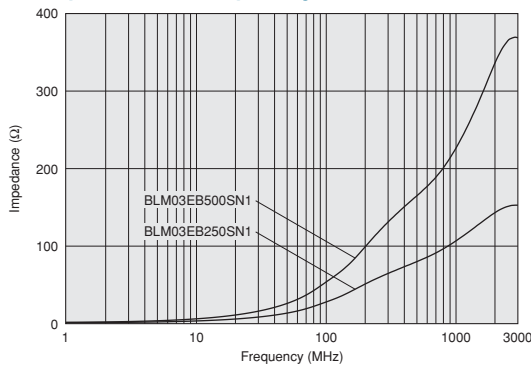

### ■ Notice (Rating)

In operating temperature exceeding +85°C, derating of current is necessary for BLM03E series.

Please apply the derating curve shown in chart according to the operating temperature.

Derating of Rated Current

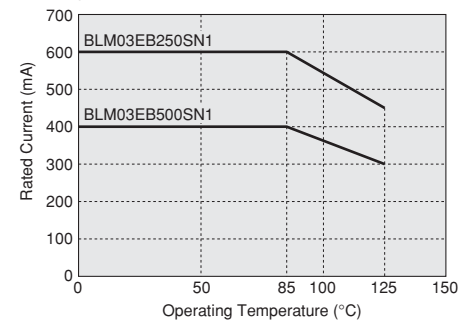

### ■ Impedance-Frequency Characteristics

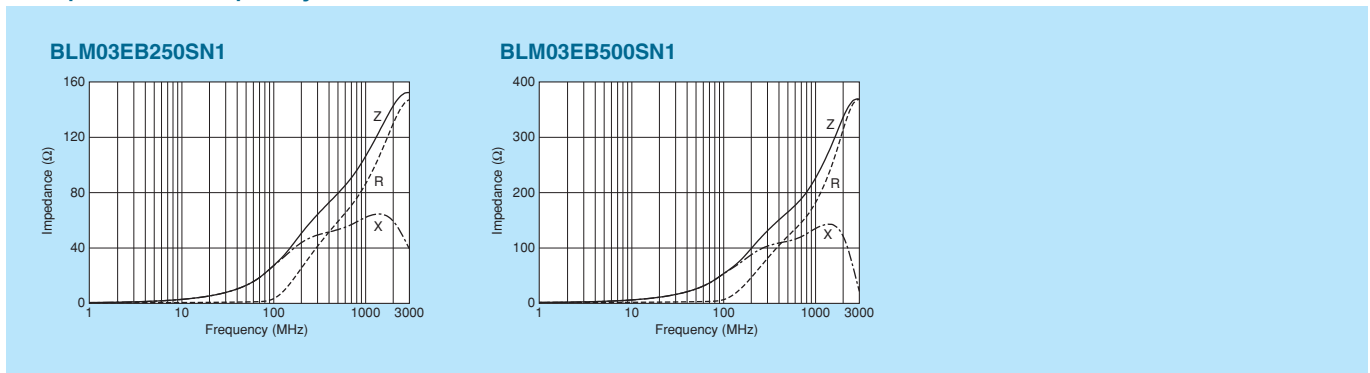

△Note • Please read rating and △CAUTION (for storage, operating, rating, soldering, mounting and handling) in this catalog to prevent smoking and/or burning, etc.  
• This catalog has only typical specifications. Therefore, please approve our product specifications or transact the approval sheet for product specifications before ordering.

# BLM15H Series 0402/1005 (inch/mm)



0402 size for GHz band noise.

Chip Ferrite Bead  
0402/1005 (inch/mm)

Chip EMIFIL®

Chip Common Mode Choke Coil

Block Type EMIFIL®

Microwave Absorber



### ■ Dimensions

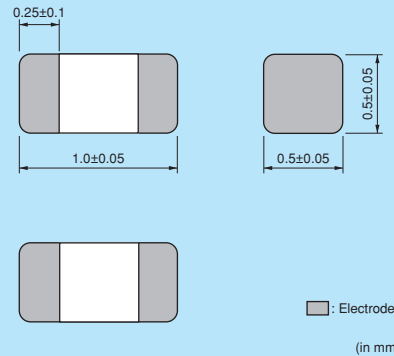

### ■ Equivalent Circuit

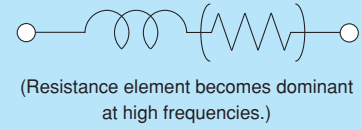

### ■ Packaging

| Code | Packaging             | Minimum Quantity |
|------|-----------------------|------------------|
| D    | 180mm Reel Paper Tape | 10000            |
| J    | 330mm Reel Paper Tape | 50000            |
| B    | Bulk(Bag)             | 1000             |

Refer to pages from p.100 to p.103 for mounting information.

### ■ Rated Value (□: packaging code)

| Part Number    | Impedance (at 100MHz/20°C) | Impedance (at 1GHz/20°C) | Rated Current | DC Resistance | Operating Temperature Range |     |
|----------------|----------------------------|--------------------------|---------------|---------------|-----------------------------|-----|
| BLM15HG601SN1□ | 600ohm ±25%                | 1000ohm ±40%             | 300mA         | 0.7ohm max.   | -55°C to +125°C             | Kit |
| BLM15HG102SN1□ | 1000ohm ±25%               | 1400ohm ±40%             | 250mA         | 1.1ohm max.   | -55°C to +125°C             | Kit |
| BLM15HD601SN1□ | 600ohm ±25%                | 1400ohm ±40%             | 300mA         | 0.85ohm max.  | -55°C to +125°C             | Kit |
| BLM15HD102SN1□ | 1000ohm ±25%               | 2000ohm ±40%             | 250mA         | 1.25ohm max.  | -55°C to +125°C             | Kit |
| BLM15HD182SN1□ | 1800ohm ±25%               | 2700ohm ±40%             | 200mA         | 2.2ohm max.   | -55°C to +125°C             | Kit |
| BLM15HB121SN1□ | 120ohm ±25%                | 500ohm ±40%              | 300mA         | 0.7ohm max.   | -55°C to +125°C             | Kit |
| BLM15HB221SN1□ | 220ohm ±25%                | 900ohm ±40%              | 250mA         | 1.0ohm max.   | -55°C to +125°C             | Kit |

Number of Circuits: 1

### ■ Impedance-Frequency Characteristics

#### BLM15HG Series (For General Signal Lines)

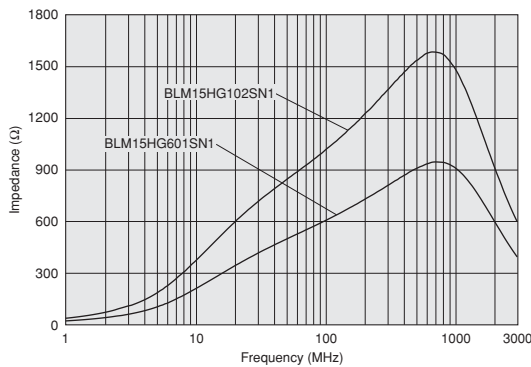

#### BLM15HD Series (For High Speed Signal Lines)

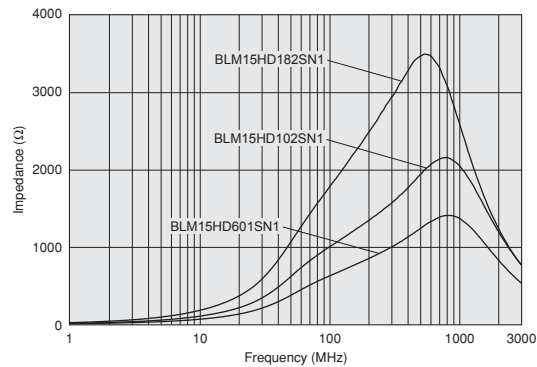

#### BLM15HB Series (For High Speed Signal Lines)

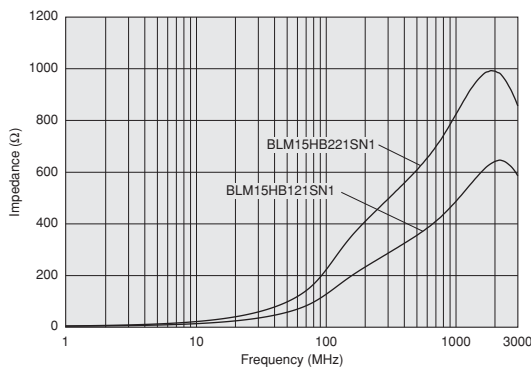

Continued on the following page.

△Note • Please read rating and △CAUTION (for storage, operating, rating, soldering, mounting and handling) in this catalog to prevent smoking and/or burning, etc.  
• This catalog has only typical specifications. Therefore, please approve our product specifications or transact the approval sheet for product specifications before ordering.

Impedance-Frequency Characteristics

BLM15HG601SN1

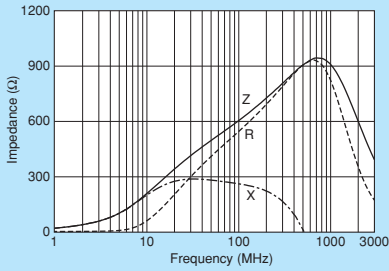

BLM15HG102SN1

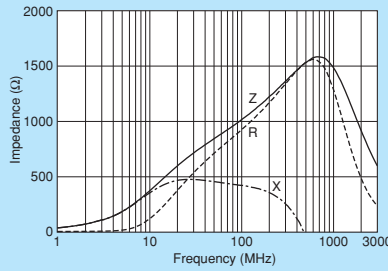

BLM15HD601SN1

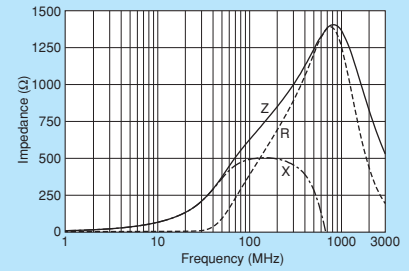

BLM15HD102SN1

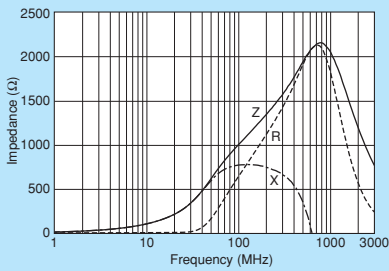

BLM15HD182SN1

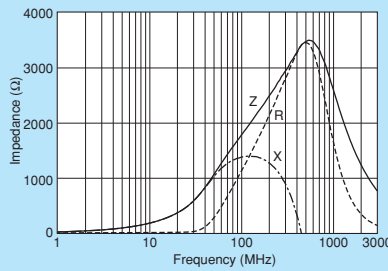

BLM15HB121SN1

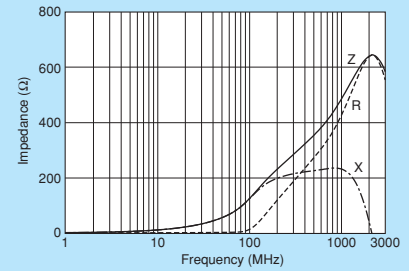

BLM15HB221SN1

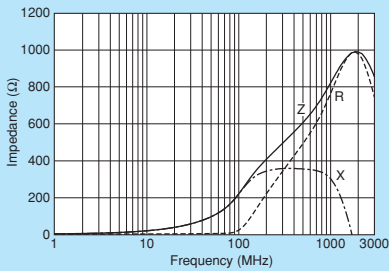

0402/1005 (inch/mm)  
Chip Ferrite Bead

Chip EMIFIL®

Chip Common Mode Choke Coil

Block Type EMIFIL®

Microwave Absorber

⚠Note • Please read rating and ⚠CAUTION (for storage, operating, rating, soldering, mounting and handling) in this catalog to prevent smoking and/or burning, etc.  
 • This catalog has only typical specifications. Therefore, please approve our product specifications or transact the approval sheet for product specifications before ordering.

# BLM15E Series 0402/1005 (inch/mm)



For GHz band noise, also capable to large current.

Chip Ferrite Bead 0402/1005 (inch/mm)



### Dimensions

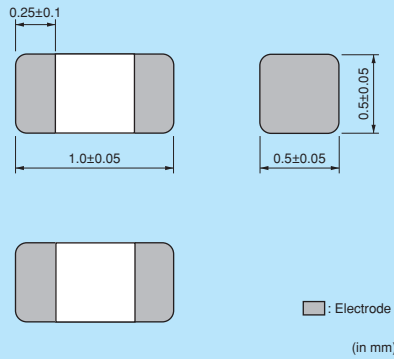

### Equivalent Circuit

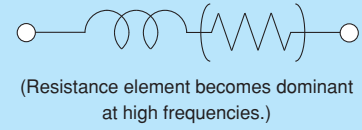

### Packaging

| Code | Packaging             | Minimum Quantity |
|------|-----------------------|------------------|
| D    | 180mm Reel Paper Tape | 10000            |
| J    | 330mm Reel Paper Tape | 50000            |
| B    | Bulk(Bag)             | 1000             |

Refer to pages from p.100 to p.103 for mounting information.

### Rated Value (□: packaging code)

| Part Number    | Impedance (at 100MHz/20°C) | Impedance (at 1GHz/20°C) | Rated Current | DC Resistance | Operating Temperature Range |         |
|----------------|----------------------------|--------------------------|---------------|---------------|-----------------------------|---------|
| BLM15EG121SN1□ | 120ohm ±25%                | 145ohm (Typ.)            | 1500mA        | 0.095ohm max. | -55°C to +125°C             | Kit ≥1A |
| BLM15EG221SN1□ | 220ohm ±25%                | 270ohm (Typ.)            | 700mA         | 0.28ohm max.  | -55°C to +125°C             | Kit     |

Number of Circuits: 1

Chip EMIFIL®

### Impedance-Frequency Characteristics

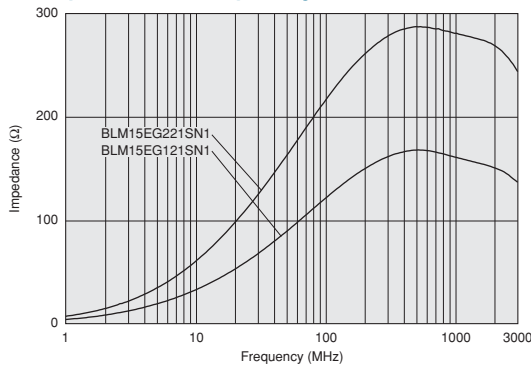

### Notice (Rating)

In operating temperature exceeding +85°C, derating of current is necessary for BLM15E series. Please apply the derating curve shown in chart according to the operating temperature.

#### Derating of Rated Current

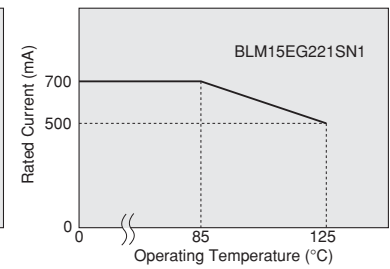
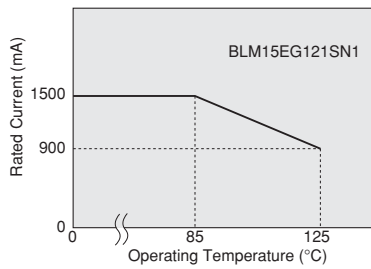

Chip Common Mode Choke Coil

### Impedance-Frequency Characteristics

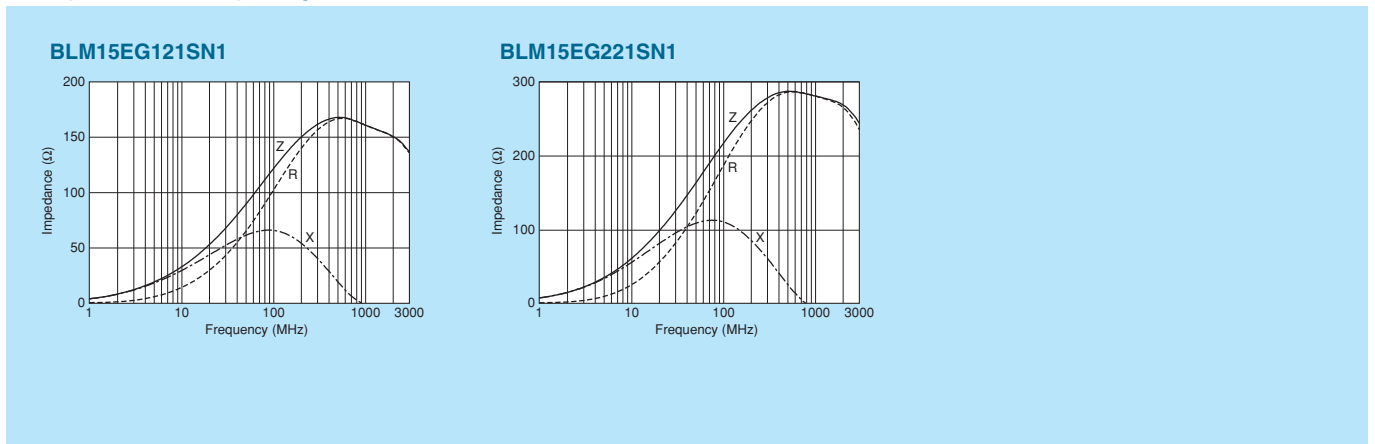

Block Type EMIFIL®

Microwave Absorber

△Note • Please read rating and △CAUTION (for storage, operating, rating, soldering, mounting and handling) in this catalog to prevent smoking and/or burning, etc.  
• This catalog has only typical specifications. Therefore, please approve our product specifications or transact the approval sheet for product specifications before ordering.

# BLM15G Series 0402/1005 (inch/mm)



Available up to high-GHz band noise.



### ■ Dimensions



(in mm)

### ■ Equivalent Circuit



(Resistance element becomes dominant at high frequencies.)

### ■ Packaging

| Code | Packaging             | Minimum Quantity |
|------|-----------------------|------------------|
| D    | 180mm Reel Paper Tape | 10000            |
| J    | 330mm Reel Paper Tape | 50000            |
| B    | Bulk(Bag)             | 1000             |

Refer to pages from p.100 to p.103 for mounting information.

### ■ Rated Value (□: packaging code)

| Part Number    | Impedance (at 100MHz/20°C) | Impedance (at 1GHz/20°C) | Rated Current | DC Resistance | Operating Temperature Range |     |
|----------------|----------------------------|--------------------------|---------------|---------------|-----------------------------|-----|
| BLM15GG221SN1□ | 220ohm ±25%                | 600ohm ±40%              | 300mA         | 0.7ohm max.   | -55°C to +125°C             | Kit |
| BLM15GG471SN1□ | 470ohm ±25%                | 1200ohm ±40%             | 200mA         | 1.3ohm max.   | -55°C to +125°C             | Kit |
| BLM15GA750SN1□ | 75ohm ±25%                 | 1000ohm ±40%             | 200mA         | 1.3ohm max.   | -55°C to +125°C             | Kit |

Number of Circuits: 1

### ■ Impedance-Frequency Characteristics

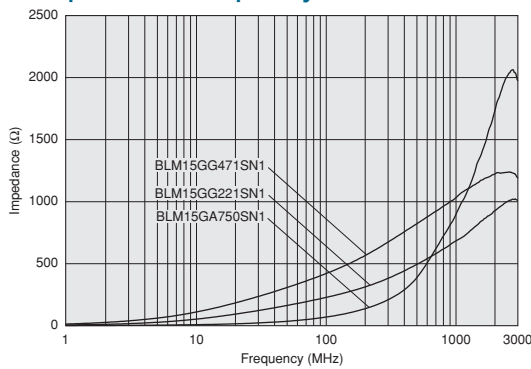

### ■ Impedance-Frequency Characteristics

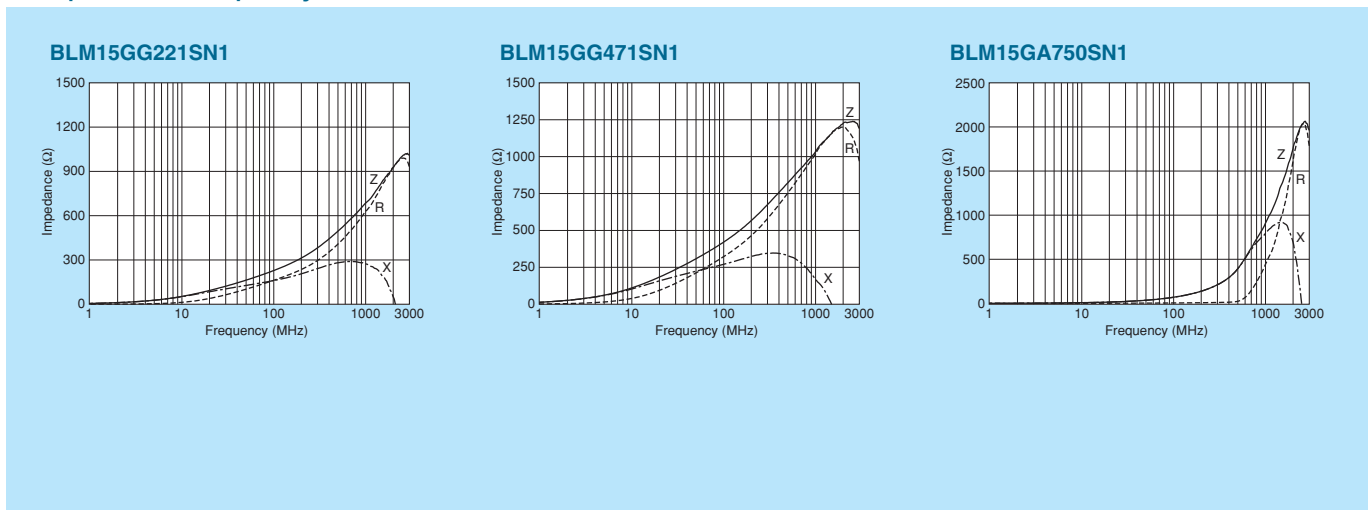

⚠Note • Please read rating and ⚠CAUTION (for storage, operating, rating, soldering, mounting and handling) in this catalog to prevent smoking and/or burning, etc.  
 • This catalog has only typical specifications. Therefore, please approve our product specifications or transact the approval sheet for product specifications before ordering.

# BLM18H Series 0603/1608 (inch/mm)



0603 size for GHz band noise. BLM18HE also supports power lines.

\*Please refer to BLM15H for downsizing.

Chip Ferrite Bead  
0603/1608 (inch/mm)

Chip EMIFIL®

Chip Common Mode Choke Coil

Block Type EMIFIL®

Microwave Absorber



### ■ Dimensions

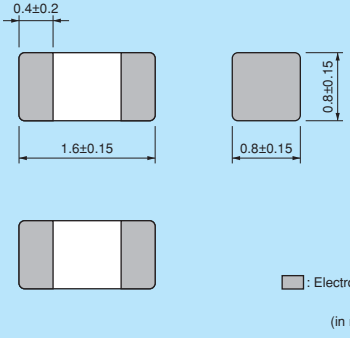

(in mm)

### ■ Equivalent Circuit



(Resistance element becomes dominant at high frequencies.)

### ■ Packaging

| Code | Packaging             | Minimum Quantity |
|------|-----------------------|------------------|
| D    | 180mm Reel Paper Tape | 4000             |
| J    | 330mm Reel Paper Tape | 10000            |
| B    | Bulk(Bag)             | 1000             |

Refer to pages from p.100 to p.103 for mounting information.

### ■ Rated Value (□: packaging code)

| Part Number    | Impedance (at 100MHz/20°C) | Impedance (at 1GHz/20°C) | Rated Current | DC Resistance | Operating Temperature Range |     |
|----------------|----------------------------|--------------------------|---------------|---------------|-----------------------------|-----|
| BLM18HG471SN1□ | 470ohm ±25%                | 600ohm (Typ.)            | 200mA         | 0.85ohm max.  | -55°C to +125°C             | Kit |
| BLM18HG601SN1□ | 600ohm ±25%                | 700ohm (Typ.)            | 200mA         | 1.00ohm max.  | -55°C to +125°C             | Kit |
| BLM18HG102SN1□ | 1000ohm ±25%               | 1000ohm (Typ.)           | 100mA         | 1.60ohm max.  | -55°C to +125°C             | Kit |
| BLM18HE601SN1□ | 600ohm ±25%                | 600ohm (Typ.)            | 800mA         | 0.25ohm max.  | -55°C to +125°C             | Kit |
| BLM18HE102SN1□ | 1000ohm ±25%               | 1000ohm (Typ.)           | 600mA         | 0.35ohm max.  | -55°C to +125°C             | Kit |
| BLM18HE152SN1□ | 1500ohm ±25%               | 1500ohm (Typ.)           | 500mA         | 0.50ohm max.  | -55°C to +125°C             | Kit |
| BLM18HD471SN1□ | 470ohm ±25%                | 1000ohm (Typ.)           | 100mA         | 1.20ohm max.  | -55°C to +125°C             | Kit |
| BLM18HD601SN1□ | 600ohm ±25%                | 1200ohm (Typ.)           | 100mA         | 1.50ohm max.  | -55°C to +125°C             | Kit |
| BLM18HD102SN1□ | 1000ohm ±25%               | 1700ohm (Typ.)           | 50mA          | 1.80ohm max.  | -55°C to +125°C             | Kit |
| BLM18HB121SN1□ | 120ohm ±25%                | 500ohm ±40%              | 200mA         | 0.50ohm max.  | -55°C to +125°C             | Kit |
| BLM18HB221SN1□ | 220ohm ±25%                | 1100ohm ±40%             | 100mA         | 0.80ohm max.  | -55°C to +125°C             | Kit |
| BLM18HB331SN1□ | 330ohm ±25%                | 1600ohm ±40%             | 50mA          | 1.20ohm max.  | -55°C to +125°C             | Kit |
| BLM18HK331SN1□ | 330ohm ±25%                | 400ohm ±40%              | 200mA         | 0.50ohm max.  | -55°C to +125°C             | Kit |
| BLM18HK471SN1□ | 470ohm ±25%                | 600ohm ±40%              | 200mA         | 0.70ohm max.  | -55°C to +125°C             | Kit |
| BLM18HK601SN1□ | 600ohm ±25%                | 700ohm ±40%              | 100mA         | 0.90ohm max.  | -55°C to +125°C             | Kit |
| BLM18HK102SN1□ | 1000ohm ±25%               | 1200ohm ±40%             | 50mA          | 1.50ohm max.  | -55°C to +125°C             | Kit |

Number of Circuits: 1

### ■ Impedance-Frequency Characteristics

#### BLM18HG Series (For General Signal Lines)

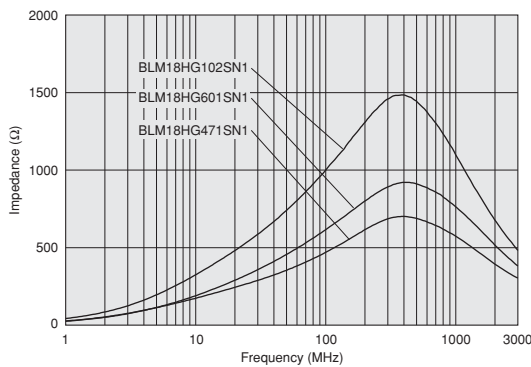

#### BLM18HE Series (For High Speed Signal Lines)

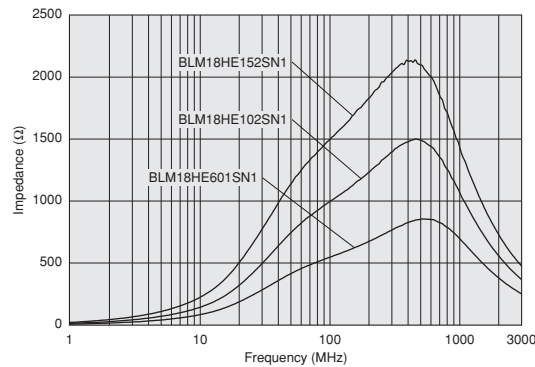

Continued on the following page. ↗

△Note • Please read rating and △CAUTION (for storage, operating, rating, soldering, mounting and handling) in this catalog to prevent smoking and/or burning, etc.  
• This catalog has only typical specifications. Therefore, please approve our product specifications or transact the approval sheet for product specifications before ordering.

**Impedance-Frequency Characteristics**  
**BLM18HD Series (For High Speed Signal Lines)**

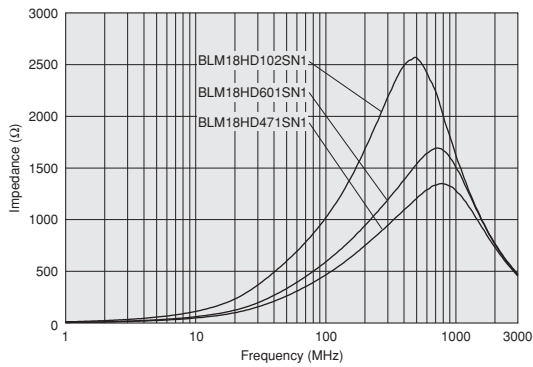

**BLM18HB Series (For High Speed Signal Lines)**

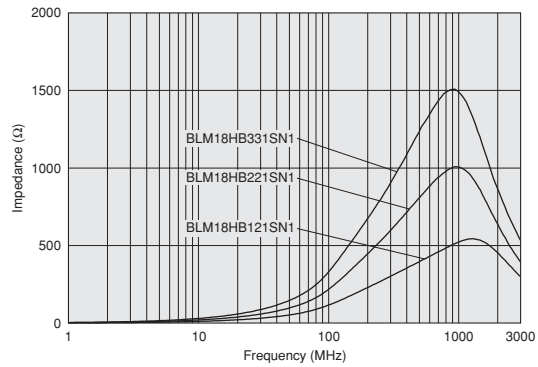

**BLM18HK Series (For Digital Interface Lines)**

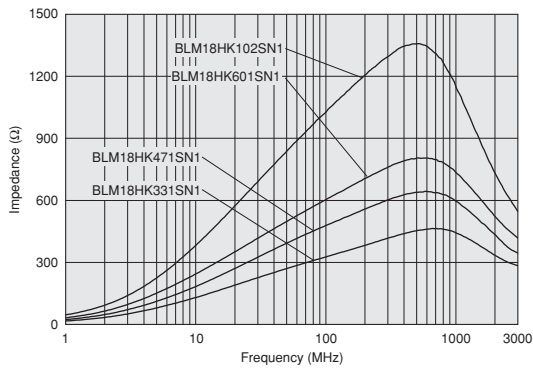

**Notice (Rating)**

In operating temperature exceeding +85°C, derating of current is necessary for BLM18HE series.

Please apply the derating curve shown in chart according to the operating temperature.

Derating of Rated Current

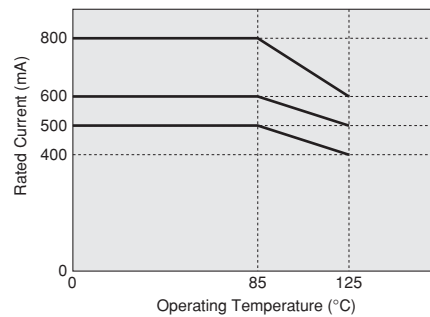

**Impedance-Frequency Characteristics**

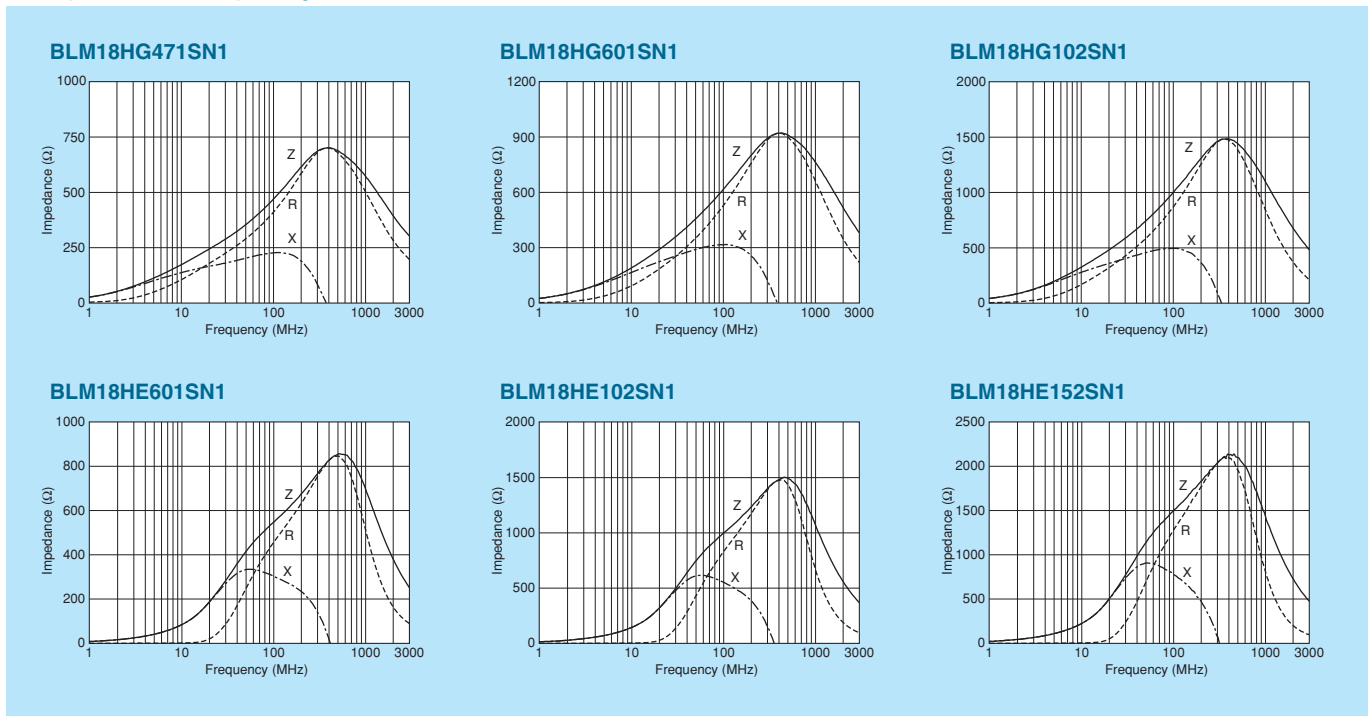

Continued on the following page.

**Note** • Please read rating and **CAUTION** (for storage, operating, rating, soldering, mounting and handling) in this catalog to prevent smoking and/or burning, etc.  
 • This catalog has only typical specifications. Therefore, please approve our product specifications or transact the approval sheet for product specifications before ordering.

Impedance-Frequency Characteristics

BLM18HD471SN1

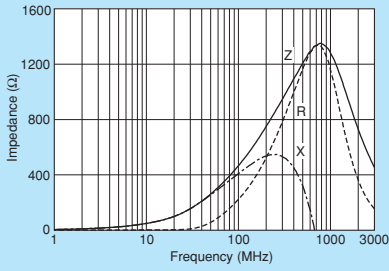

BLM18HD601SN1

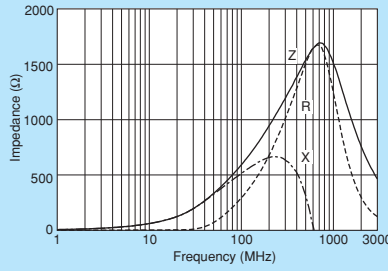

BLM18HD102SN1

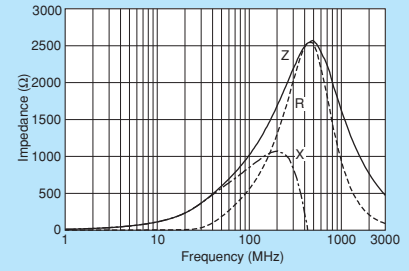

BLM18HB121SN1

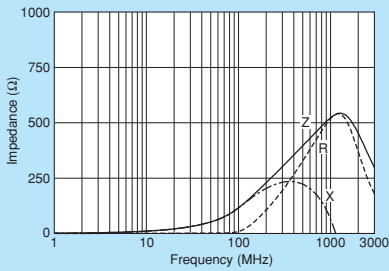

BLM18HB221SN1

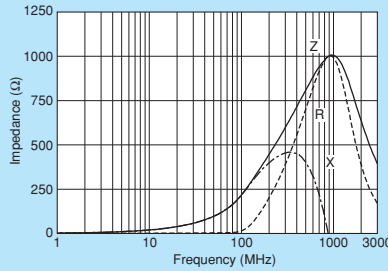

BLM18HB331SN1

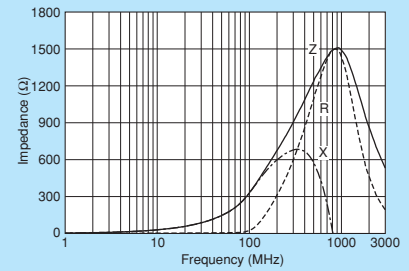

BLM18HK331SN1

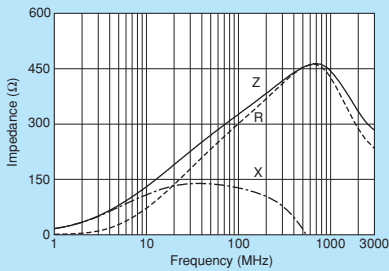

BLM18HK471SN1

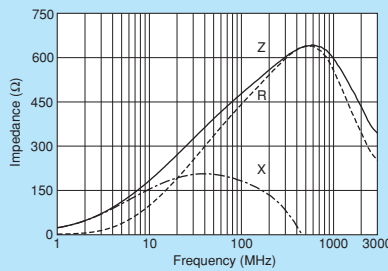

BLM18HK601SN1

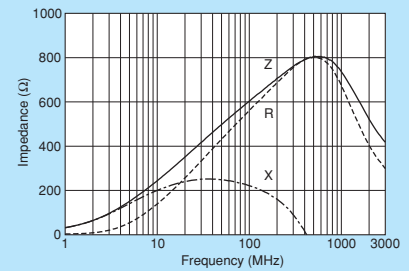

BLM18HK102SN1

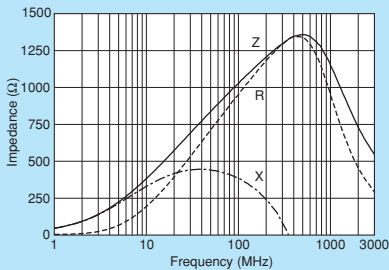

⚠ Note • Please read rating and ⚠ CAUTION (for storage, operating, rating, soldering, mounting and handling) in this catalog to prevent smoking and/or burning, etc.  
 • This catalog has only typical specifications. Therefore, please approve our product specifications or transact the approval sheet for product specifications before ordering.

Chip Ferrite Bead  
0603/1608 (inch/mm)

Chip EMIFIL®

Chip Common Mode Choke Coil

Block Type EMIFIL®

Microwave Absorber



# Noise Suppression of BLM18H in UHF Range

Testing Circuit

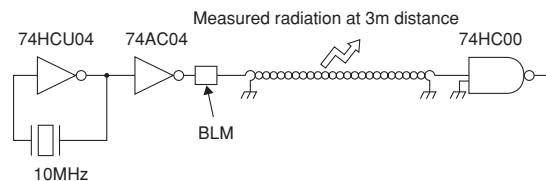

Type of Filter | EMI Suppression Effect / Description

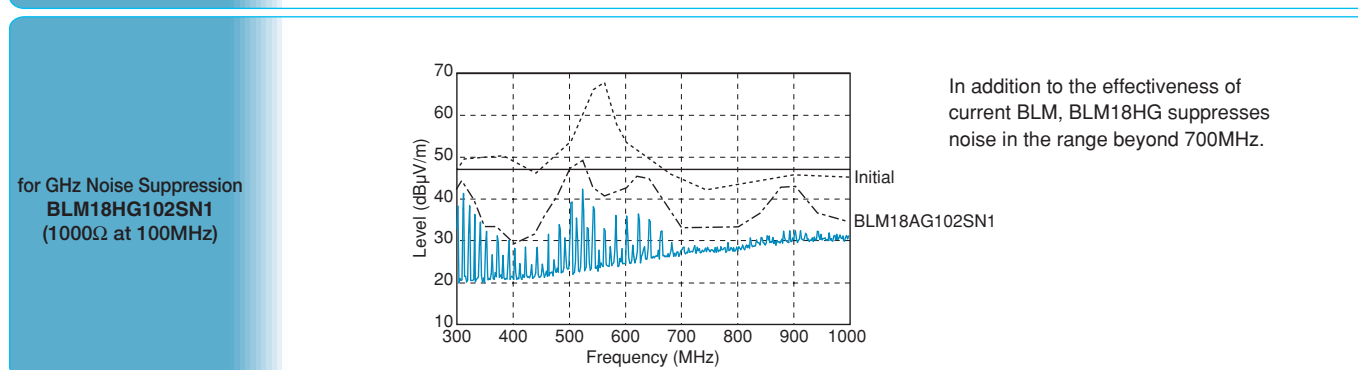
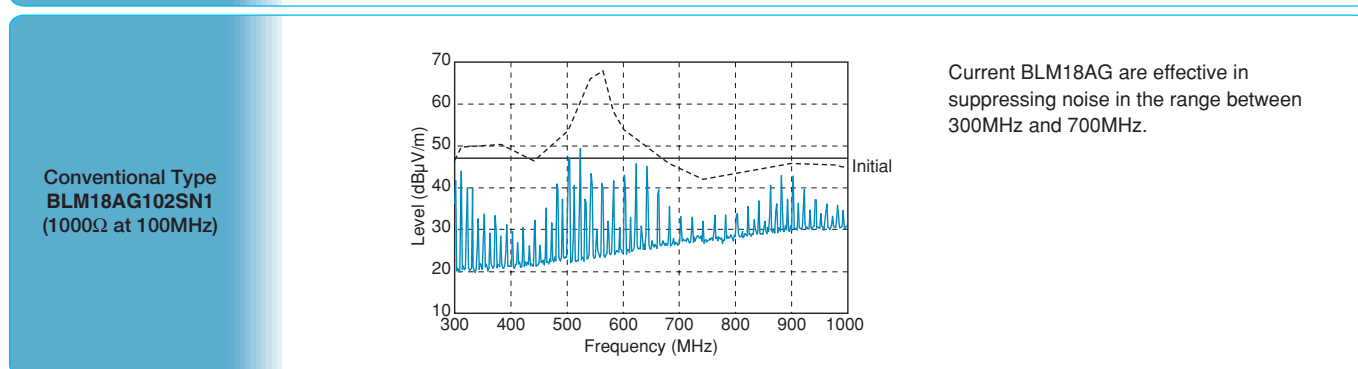
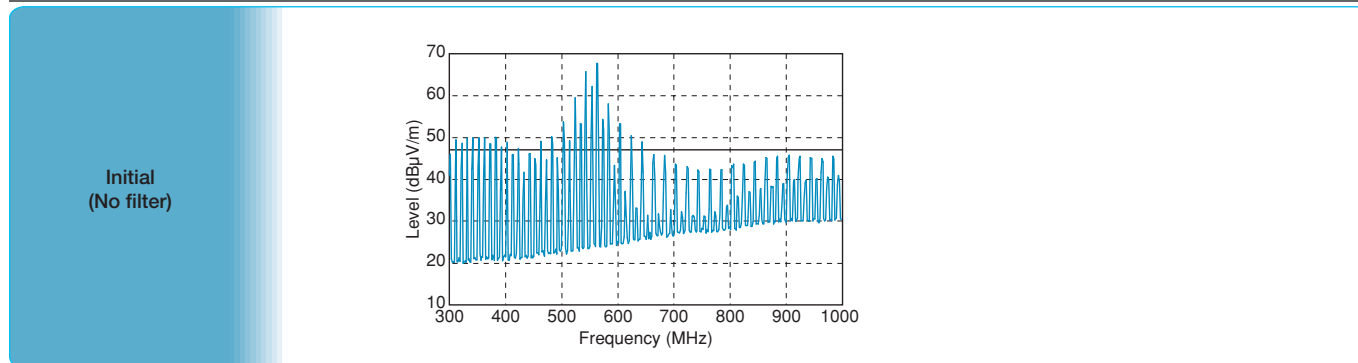

Comparison between BLM18HG102SN1 and BLM18AG102SN1 (Current Item)

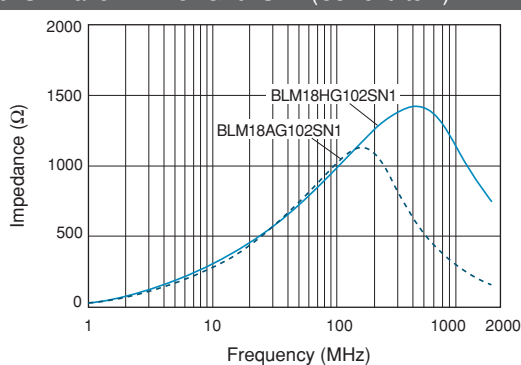

⚠Note • Please read rating and ⚠CAUTION (for storage, operating, rating, soldering, mounting and handling) in this catalog to prevent smoking and/or burning, etc.  
• This catalog has only typical specifications. Therefore, please approve our product specifications or transact the approval sheet for product specifications before ordering.

# BLM18E Series 0603/1608 (inch/mm)



For GHz band noise, also capable to large current.

Chip Ferrite Bead  
0603/1608 (inch/mm)

Chip EMIFIL®

Chip Common Mode Choke Coil

Block Type EMIFIL®

Microwave Absorber



### ■ Dimensions

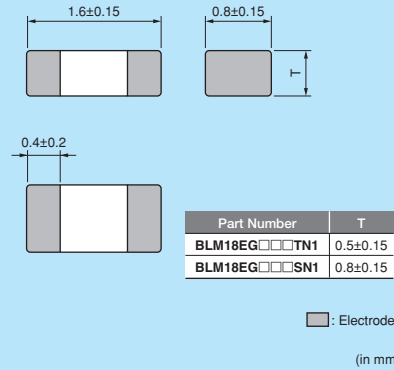

### ■ Equivalent Circuit

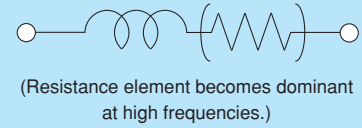

### ■ Packaging

| Code | Packaging             | Minimum Quantity |
|------|-----------------------|------------------|
| D    | 180mm Reel Paper Tape | 4000             |
| J    | 330mm Reel Paper Tape | 10000            |
| B    | Bulk(Bag)             | 1000             |

Refer to pages from p.100 to p.103 for mounting information.

### ■ Rated Value (□: packaging code)

| Part Number    | Impedance (at 100MHz/20°C) | Impedance (at 1GHz/20°C) | Rated Current | DC Resistance | Operating Temperature Range | Kit     |
|----------------|----------------------------|--------------------------|---------------|---------------|-----------------------------|---------|
| BLM18EG101TN1□ | 100ohm ±25%                | 140ohm (Typ.)            | 2000mA        | 0.045ohm max. | -55°C to +125°C             | Kit ≥1A |
| BLM18EG121SN1□ | 120ohm ±25%                | 145ohm (Typ.)            | 2000mA        | 0.04ohm max.  | -55°C to +125°C             | Kit ≥1A |
| BLM18EG221SN1□ | 220ohm ±25%                | 260ohm (Typ.)            | 2000mA        | 0.05ohm max.  | -55°C to +125°C             | Kit ≥1A |
| BLM18EG221TN1□ | 220ohm ±25%                | 300ohm (Typ.)            | 1000mA        | 0.15ohm max.  | -55°C to +125°C             | Kit ≥1A |
| BLM18EG331TN1□ | 330ohm ±25%                | 450ohm (Typ.)            | 500mA         | 0.21ohm max.  | -55°C to +125°C             | Kit     |
| BLM18EG391TN1□ | 390ohm ±25%                | 520ohm (Typ.)            | 500mA         | 0.3ohm max.   | -55°C to +125°C             | Kit     |
| BLM18EG471SN1□ | 470ohm ±25%                | 550ohm (Typ.)            | 500mA         | 0.21ohm max.  | -55°C to +125°C             | Kit     |
| BLM18EG601SN1□ | 600ohm ±25%                | 700ohm (Typ.)            | 500mA         | 0.35ohm max.  | -55°C to +125°C             | Kit     |

Number of Circuits: 1

### ■ Impedance-Frequency Characteristics BLM18EG\_TN1 Series

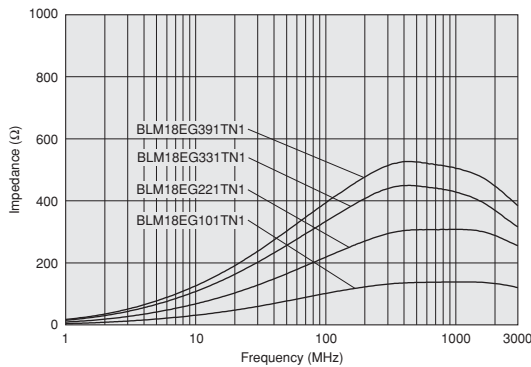

### ■ Impedance-Frequency Characteristics BLM18EG\_SN1 Series

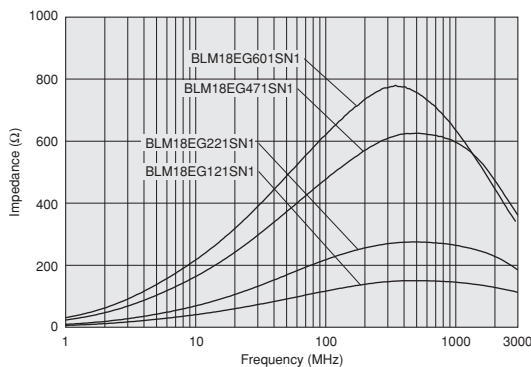

### ■ Notice (Rating)

In operating temperature exceeding +85°C, derating of current is necessary for BLM18EG series. Please apply the derating curve shown in chart according to the operating temperature.

Derating of Rated Current

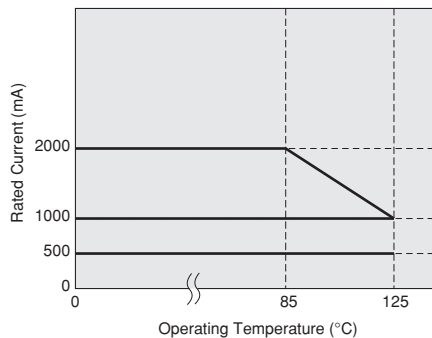

Continued on the following page.

△Note • Please read rating and △CAUTION (for storage, operating, rating, soldering, mounting and handling) in this catalog to prevent smoking and/or burning, etc.  
 • This catalog has only typical specifications. Therefore, please approve our product specifications or transact the approval sheet for product specifications before ordering.

Impedance-Frequency Characteristics

BLM18EG101TN1

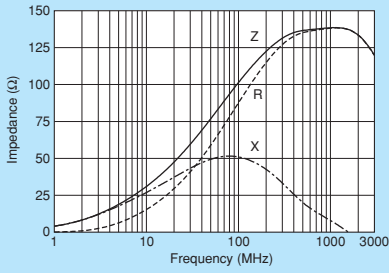

BLM18EG121SN1

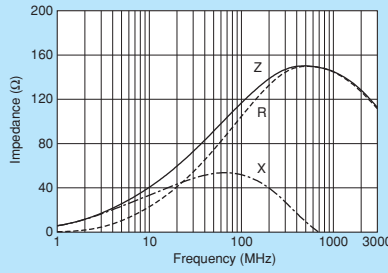

BLM18EG221SN1

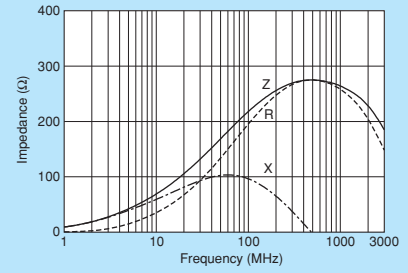

BLM18EG221TN1

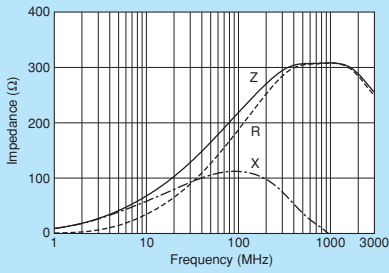

BLM18EG331TN1

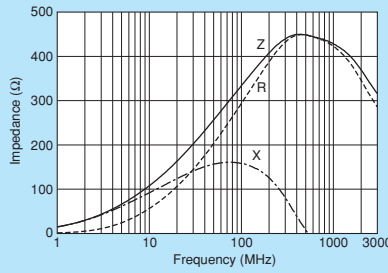

BLM18EG391TN1

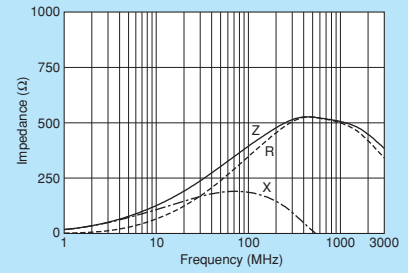

BLM18EG471SN1

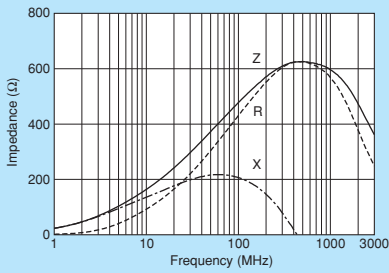

BLM18EG601SN1

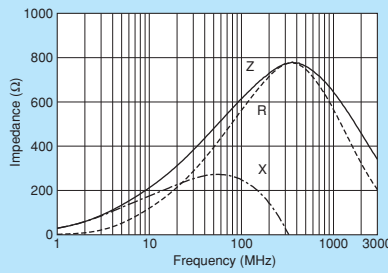

0603/1608 (inch/mm)  
Chip Ferrite Bead

Chip EMIFIL®

Chip Common Mode Choke Coil

Block Type EMIFIL®

Microwave Absorber

⚠ Note • Please read rating and ⚠ CAUTION (for storage, operating, rating, soldering, mounting and handling) in this catalog to prevent smoking and/or burning, etc.  
 • This catalog has only typical specifications. Therefore, please approve our product specifications or transact the approval sheet for product specifications before ordering.

# BLM18G Series 0603/1608 (inch/mm)



Available up to high-GHz band noise.

Chip Ferrite Bead  
0603/1608 (inch/mm)



### ■ Dimensions

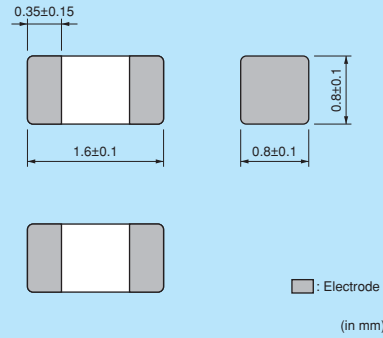

### ■ Equivalent Circuit

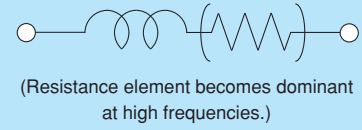

### ■ Packaging

| Code | Packaging             | Minimum Quantity |
|------|-----------------------|------------------|
| D    | 180mm Reel Paper Tape | 4000             |
| J    | 330mm Reel Paper Tape | 10000            |
| B    | Bulk(Bag)             | 1000             |

Refer to pages from p.100 to p.103 for mounting information.

### ■ Rated Value (□: packaging code)

| Part Number    | Impedance (at 100MHz/20°C) | Impedance (at 1GHz/20°C) | Rated Current | DC Resistance  | Operating Temperature Range |     |
|----------------|----------------------------|--------------------------|---------------|----------------|-----------------------------|-----|
| BLM18GG471SN1□ | 470ohm ±25%                | 1800ohm ±30%             | 200mA         | 1.0ohm ±0.3ohm | -55°C to +125°C             | Kit |

Number of Circuits: 1

Chip EMIFIL®

Chip Common Mode Choke Coil

### ■ Impedance-Frequency Characteristics

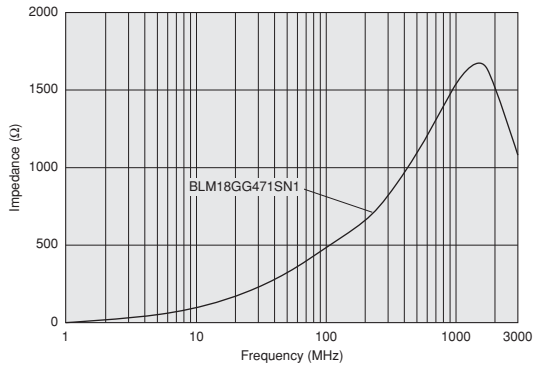

Block Type EMIFIL®

### ■ Impedance-Frequency Characteristics

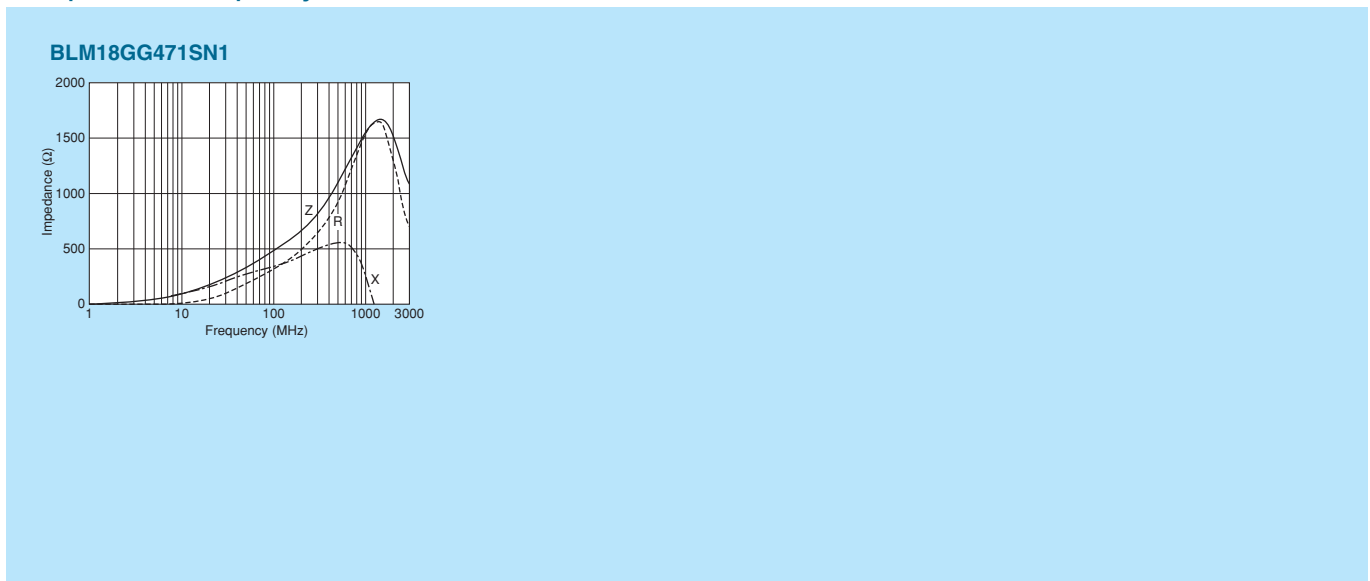

△Note • Please read rating and △CAUTION (for storage, operating, rating, soldering, mounting and handling) in this catalog to prevent smoking and/or burning, etc.  
• This catalog has only typical specifications. Therefore, please approve our product specifications or transact the approval sheet for product specifications before ordering.

Microwave Absorber

## ⚠ Caution

## ● Rating

1. About the Rated Current  
Do not use products beyond the rated current as this may create excessive heat and deteriorate the insulation resistance.
2. About the Excessive Surge Current  
Excessive surge current ( pulse current or rush current) than specified rated current applied to the product may cause a critical failure, such as an open circuit, burnout caused by excessive temperature rise. Please contact us in advance in case of applying the surge current.

## ● Soldering and Mounting

- Self-heating  
Please pay special attention when mounting chip ferrite beads BLM\_AX/P/K/S series bead inductor BLE series in close proximity to other products that radiate heat.  
The heat generated by other products may deteriorate the insulation resistance and cause excessive heat in this component.

## Notice

## ● Storage and Operating Conditions

## &lt;Operating Environment&gt;

Do not use products in a chemical atmosphere such as chlorine gas, acid or sulfide gas.

Do not use products in the environment close to the organic solvent.

## &lt;Storage and Handling Requirements&gt;

1. Storage Period  
BLM15E/15H/15G series should be used within 12 months, the other series should be used within 6 months.  
Solderability should be checked if this period is exceeded.
2. Storage Conditions
  - (1) Storage temperature: -10 to +40°C  
Relative humidity: 15 to 85%  
Avoid sudden changes in temperature and humidity.
  - (2) Do not store products in a chemical atmosphere such as chlorine gas, acid or sulfide gas.

## ● Notice (Soldering and Mounting)

1. Cleaning  
Failure and degradation of a product are caused by the cleaning method. When you clean in conditions that are not in mounting information, please contact Murata engineering.
2. Soldering  
Reliability decreases with improper soldering methods. Please solder by the standard soldering conditions shown in mounting information.
3. Other  
Noise suppression levels resulting from Murata's EMI suppression filters EMIFIL® may vary, depending on the circuits and ICs used, type of noise, mounting pattern, mounting location, and other operating conditions. Be sure to check and confirm in advance the noise suppression effect of each filter, in actual circuits, etc. before applying the filter in a commercial-purpose equipment design.

## ● Handling

1. Resin Coating  
Using resin for coating/molding products may affect the products performance.  
So please pay careful attention in selecting resin.  
Prior to use, please make the reliability evaluation with the product mounted in your application set.
2. Handling of a Substrate  
After mounting products on a substrate, do not apply any stress to the product caused by bending or twisting to the substrate when cropping the substrate, inserting and removing a connector from the substrate or tightening screw to the substrate.  
Excessive mechanical stress may cause cracking in the Product.

Bending

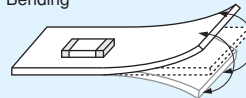

Twisting

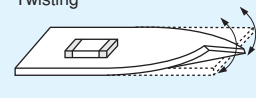

⚠ Note • Please read rating and ⚠ CAUTION (for storage, operating, rating, soldering, mounting and handling) in this catalog to prevent smoking and/or burning, etc.  
• This catalog has only typical specifications. Therefore, please approve our product specifications or transact the approval sheet for product specifications before ordering.

### 1. Standard Land Pattern Dimensions

  
 Land Pattern + Solder Resist
   
 Land Pattern
   
 Solder Resist

(in mm)

**BLE32**  
**BLM02**  
**BLM03**  
**BLM15**  
**BLM18**  
**BLM21**  
**BLM31**  
**BLM41**

●Reflow and Flow  
BLM Series

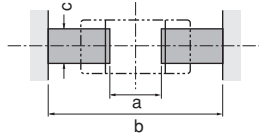

| Type                         | Soldering       | a        | b        | c        |
|------------------------------|-----------------|----------|----------|----------|
| <b>BLM02</b>                 | Reflow          | 0.16-0.2 | 0.4-0.56 | 0.2-0.23 |
| <b>BLM03</b>                 | Reflow          | 0.2-0.3  | 0.6-0.9  | 0.3      |
| <b>BLM15</b>                 | Reflow          | 0.4      | 1.2-1.4  | 0.5      |
| <b>BLM18</b><br>(except 18G) | Flow            | 0.7      | 2.2-2.6  | 0.7      |
|                              | Reflow          |          | 1.8-2.0  |          |
| <b>BLM21</b>                 | Flow/<br>Reflow | 1.2      | 3.0-4.0  | 1.0      |

• Except for BLM03PG·PX·EB/15AX·PD·PG·PX/18PG·KG·SG/21PG. And BLM02/03/15/18G is specially adapted for reflow soldering.

BLE32PN·BLM□□AX/P/K/S/E

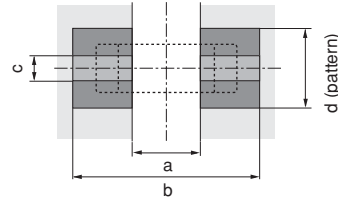

| Type           | Rated Current (A) | Soldering       | a       | b                                    | c   | Land Pad Thickness and Dimension d |                                 |      |
|----------------|-------------------|-----------------|---------|--------------------------------------|-----|------------------------------------|---------------------------------|------|
|                |                   |                 |         |                                      |     | 18μm                               | 35μm                            | 70μm |
| <b>BLE32PN</b> | 10                | Flow/<br>Reflow | 1.9     | 3.6                                  | 2.7 | -                                  | 4.0 (Temperature 85°C or less)  | -    |
|                |                   |                 |         |                                      |     | -                                  | 8.0 (Temperature 125°C or less) | -    |
| <b>BLM03AX</b> | 0.9max.           | Reflow          | 0.2-0.3 | 0.6-0.9                              | 0.3 | 0.3                                | 0.3                             | 0.3  |
| <b>BLM03P□</b> | 1.8max.           |                 |         |                                      |     | 1.2                                | 0.7                             | 0.3  |
| <b>BLM03EB</b> | 1.5max.           | Reflow          | 0.4     | 1.2-1.4                              | 0.5 | 0.5                                | 0.5                             | 0.5  |
| <b>BLM15AX</b> | 2.2max.           |                 |         |                                      |     | 1.2                                | 0.7                             | 0.5  |
| <b>BLM15PD</b> | 3.0max.           |                 |         |                                      |     | 2.4                                | 1.2                             | 0.5  |
| <b>BLM15PG</b> |                   |                 |         |                                      |     |                                    |                                 |      |
| <b>BLM15PX</b> |                   |                 |         |                                      |     |                                    |                                 |      |
| <b>BLM18PG</b> | 0.5-1.5           | Flow/<br>Reflow | 0.7     | Flow<br>2.2-2.6<br>Reflow<br>1.8-2.0 | 0.7 | 0.7                                | 0.7                             | 0.7  |
|                | 1.7-2.5           |                 |         |                                      |     | 1.2                                | 0.7                             | 0.7  |
|                | 3-4               |                 |         |                                      |     | 2.4                                | 1.2                             | 0.7  |
|                | 5-6               |                 |         |                                      |     | 6.4                                | 3.3                             | 1.65 |
| <b>BLM21PG</b> | 1.5               | Flow/<br>Reflow | 1.2     | 3.0-4.0                              | 1.0 | 1.0                                | 1.0                             | 1.0  |
|                | 2                 |                 |         |                                      |     | 1.2                                | 1.0                             | 1.0  |
|                | 3-4               |                 |         |                                      |     | 2.4                                | 1.2                             | 1.0  |
|                | 6                 |                 |         |                                      |     | 6.4                                | 3.3                             | 1.65 |
| <b>BLM31PG</b> | 1.5-2             | Flow/<br>Reflow | 2.0     | 4.2-5.2                              | 1.2 | 1.2                                | 1.2                             | 1.2  |
|                | 3.5               |                 |         |                                      |     | 2.4                                | 1.2                             | 1.2  |
|                | 6                 |                 |         |                                      |     | 6.4                                | 3.3                             | 1.65 |
| <b>BLM41PG</b> | 1.5-2             | Flow/<br>Reflow | 3.0     | 5.5-6.5                              | 1.2 | 1.2                                | 1.2                             | 1.2  |
|                | 3.5               |                 |         |                                      |     | 2.4                                | 1.2                             | 1.2  |
|                | 6                 |                 |         |                                      |     | 6.4                                | 3.3                             | 1.65 |

• About land pad thickness of BLE32PN, please note the upper limit of the temperature.

• Do not apply narrower pattern than listed above to BLM□□AX/P/K/S. Narrow pattern can cause excessive heat or open circuit.

**BLA2A**  
**BLA31**

●Reflow Soldering  
BLA2A

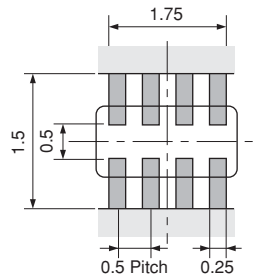

●Reflow and Flow  
BLA31

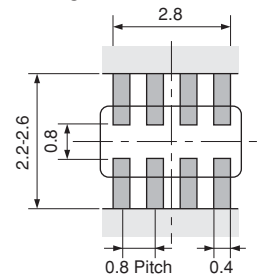

• If there are high amounts of self-heating on pattern, the contact points of PCB and part may become damaged.

⚠Note • Please read rating and ⚠CAUTION (for storage, operating, rating, soldering, mounting and handling) in this catalog to prevent smoking and/or burning, etc.  
 • This catalog has only typical specifications. Therefore, please approve our product specifications or transact the approval sheet for product specifications before ordering.

Soldering and Mounting  
 Chip Ferrite Bead  
 Chip EMIFIL®  
 Chip Common Mode Choke Coil  
 Block Type EMIFIL®  
 Microwave Absorber

● PCB Warping

PCB should be designed so that products are not subjected to the mechanical stress caused by warping the board.

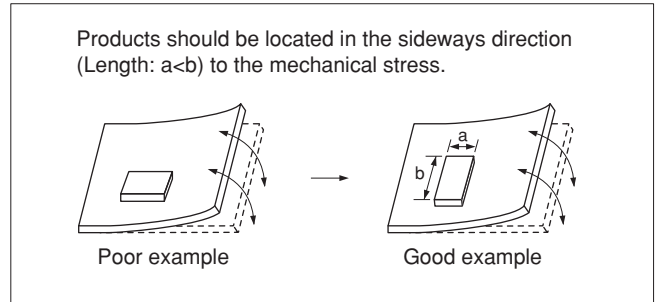

2. Solder Paste Printing and Adhesive Application

When reflow soldering the chip ferrite beads and bead inductor the printing must be conducted in accordance with the following cream solder printing conditions. If too much solder is applied, the chip will be prone to damage by mechanical and thermal stress from the PCB and may crack. Standard land dimensions should be used for resist and copper foil patterns.

When flow soldering the chip ferrite beads and bead inductor apply the adhesive in accordance with the following conditions. If too much adhesive is applied, then it may overflow into the land or termination areas and yield poor solderability. In contrast, if insufficient adhesive is applied, or if the adhesive is not sufficiently hardened, then the chip may become detached during flow soldering process.

(in mm)

| Series     | Solder Paste Printing   | Adhesive Application  |
|------------|---|---|
| BLM<br>BLE | <ul style="list-style-type: none"> <li>● Ensure that solder is applied smoothly to a minimum height of 0.2mm to 0.3mm at the end surface of the part.</li> <li>● Guideline of solder paste thickness:<br/>50-80µm: BLM02<br/>100-150µm: BLM03<br/>100-200µm: BLM15/18/21/31/41/BLE32</li> </ul> | <ul style="list-style-type: none"> <li>■ BLM18/21/31/41 Series (Except for BLM18G Series)<br/>Coating amount is illustrated in the following diagram.</li> </ul> <p>a: 20-70µm<br/>b: 30-35µm<br/>c: 50-105µm</p> |
| BLA        | <ul style="list-style-type: none"> <li>● Guideline of solder paste thickness:<br/>100-150µm: BLA2A<br/>150-200µm: BLA31</li> </ul>  | <ul style="list-style-type: none"> <li>■ BLA31 Series<br/>Coating amount is illustrated in the following diagram.</li> </ul> <p>a: 20-70µm<br/>b: 30-35µm<br/>c: 50-105µm</p>                                     |

⚠Note • Please read rating and ⚠CAUTION (for storage, operating, rating, soldering, mounting and handling) in this catalog to prevent smoking and/or burning, etc.  
• This catalog has only typical specifications. Therefore, please approve our product specifications or transact the approval sheet for product specifications before ordering.

**3. Standard Soldering Conditions**

(1) Soldering Methods

Use flow and reflow soldering methods only.  
 Use standard soldering conditions when soldering chip ferrite beads and bead inductor.  
 In cases where several different parts are soldered, each having different soldering conditions, use those conditions requiring the least heat and minimum time.

Solder: Use Sn-3.0Ag-0.5Cu solder. Use of Sn-Zn based solder will deteriorate performance of products.  
 If using BLA series with Sn-Zn based solder, please contact Murata in advance.

Flux:

- Use Rosin-based flux.  
 In case of using RA type solder, products should be cleaned completely with no residual flux.
- Do not use strong acidic flux (with chlorine content exceeding 0.20wt%)
- Do not use water-soluble flux.

For additional mounting methods, please contact Murata.

(2) Soldering Profile

● Flow Soldering Profile  
 ( Sn-3.0Ag-0.5Cu Solder)

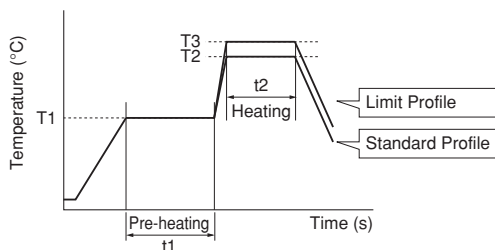

| Series  | Pre-heating |            | Standard Profile |            |               | Limit Profile |            |               |
|---|-------------|------------|------------------|------------|---------------|---------------|------------|---------------|
|   | Temp. (T1)  | Time. (t1) | Temp. (T2)       | Time. (t2) | Cycle of Flow | Temp. (T3)    | Time. (t2) | Cycle of Flow |
| <b>BLM</b> (Except for <b>BLM02/03/15/18G</b> )<br><b>BLE</b><br><b>BLA31</b> | 150°C       | 60s min.   | 250°C            | 4 to 6s    | 2 times max.  | 265±3°C       | 5s max.    | 2 times max.  |

● Reflow Soldering Profile  
 (Sn-3.0Ag-0.5Cu Solder)

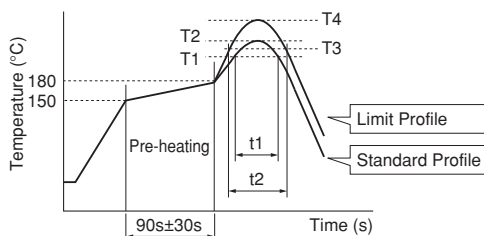

| Series                                 | Standard Profile |            |                       |                 | Limit Profile |            |                       |                 |
|--|------------------|------------|-----------------------|-----------------|---------------|------------|-----------------------|-----------------|
|  | Temp. (T1)       | Time. (t1) | Peak Temperature (T2) | Cycle of Reflow | Temp. (T3)    | Time. (t2) | Peak Temperature (T4) | Cycle of Reflow |
| <b>BLM</b><br><b>BLE</b><br><b>BLA</b> | 220°C min.       | 30 to 60s  | 245±3°C               | 2 times max.    | 230°C min.    | 60s max.   | 260°C/10s             | 2 times max.    |

△Note • Please read rating and △CAUTION (for storage, operating, rating, soldering, mounting and handling) in this catalog to prevent smoking and/or burning, etc.  
 • This catalog has only typical specifications. Therefore, please approve our product specifications or transact the approval sheet for product specifications before ordering.

Soldering and Mounting  
Chip Ferrite Bead

Chip EMIFIL®

Chip Common Mode Choke Coil

Block Type EMIFIL®

Microwave Absorber



## (3) Reworking with Solder Iron

The following conditions must be strictly followed when using a soldering iron. (Except for BLM02 Series)

Pre-heating: 150°C 60s min.

Soldering iron power output / Tip diameter:

80W max. / ø3mm max.

Temperature of soldering iron tip / Soldering time / Times:  
350°C max. / 3-4s / 2 times

Do not allow the tip of the soldering iron to directly contact the chip.

For additional methods of reworking with a soldering iron, please contact Murata engineering.

#### 4. Cleaning

Following conditions should be observed when cleaning chip ferrite beads.

(1) Cleaning Temperature: 60°C max. (40°C max. for alcohol type cleaner)

(2) Ultrasonic

Output: 20W/liter max.

Duration: 5 minutes max.

Frequency: 28 to 40kHz

(3) Cleaning Agent

The following list of cleaning agents have been tested on the individual components. Evaluation of final assembly should be completed prior to production.

(a) Alcohol cleaning agent

Isopropyl alcohol (IPA)

(b) Aqueous cleaning agent

Pine Alpha ST-100S

(4) Ensure that flux residue is completely removed.

Component should be thoroughly dried after aqueous agent has been removed with deionized water.

(5) BLM\_G type is processed with resin. On rinsing the product, using water for ultrasonic cleaning may affect the resin quality used for the product by water element. In case of set cleaning conditions, please make sure the reliability according to the cleaning conditions.

⚠Note • Please read rating and ⚠CAUTION (for storage, operating, rating, soldering, mounting and handling) in this catalog to prevent smoking and/or burning, etc.  
• This catalog has only typical specifications. Therefore, please approve our product specifications or transact the approval sheet for product specifications before ordering.

## ■ Minimum Quantity and Dimensions of 8mm Width Paper / Embossed Tape

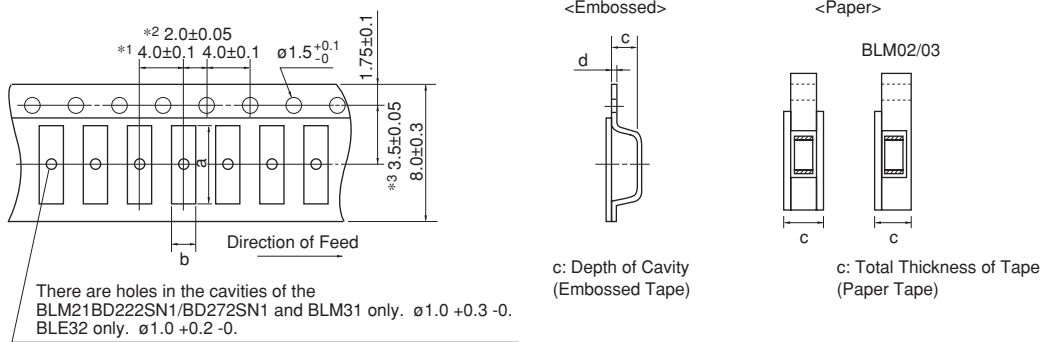

- \*1 BLM02/03/15:  $2.0 \pm 0.05$   
BLM18S/18T/BLA2A:  $2.0 \pm 0.1$
- \*2 BLA2A/31:  $2.0 \pm 0.1$
- \*3 BLA2A/31:  $3.5 \pm 0.1$

Dimension of the cavity of embossed tape is measured at the bottom side.

| Part Number          | Dimensions |      |           |      | Minimum Qty. (pcs.) |               |             |               | Bulk |
|----------------------|------------|------|-----------|------|---------------------|---------------|-------------|---------------|------|
|                      |            |      |           |      | ø180mm Reel         |               | ø330mm Reel |               |      |
|                      | a          | b    | c         | d    | Paper Tape          | Embossed Tape | Paper Tape  | Embossed Tape |      |
| BLM02                | 0.45       | 0.25 | 0.40 max. | -    | 20000               | -             | -           | -             | 1000 |
| BLM03                | 0.70       | 0.40 | 0.55 max. | -    | 15000               | -             | 50000       | -             | 1000 |
| BLM15                | 1.15       | 0.65 | 0.8 max.  | -    | 10000               | -             | 50000       | -             | 1000 |
| BLM18A/B/P/R/H/G     | 1.85       | 1.05 | 1.1 max.  | -    | 4000                | -             | 10000       | -             | 1000 |
| BLM18EG/KG_TN        | 1.85       | 1.05 | 0.85 max. | -    | 4000                | -             | 10000       | -             | 1000 |
| BLM18EG/KG_SN        |            |      | 1.1 max.  |      |                     |               |             |               |      |
| BLM18S               | 1.85       | 1.05 | 0.90 max. | -    | 10000               | -             | 30000       | -             | 1000 |
| BLM18T               | 1.85       | 1.05 | 0.90 max. | -    | 10000               | -             | -           | -             | 1000 |
| BLM21                | 2.25       | 1.45 | 1.1 max.  | -    | 4000                | -             | 10000       | -             | 1000 |
| BLM31                | 3.5        | 1.9  | 1.3       | 0.2  | -                   | 3000          | -           | 10000         | 1000 |
| BLM21BD222SN1/272SN1 | 2.25       | 1.45 | 1.3       | 0.2  | -                   | 3000          | -           | 10000         | 1000 |
| BLE32                | 3.2        | 2.8  | 2.3       | 0.25 | -                   | 1500          | -           | 7000          | 1000 |
| BLA2A                | 2.2        | 1.2  | 0.8 max.  | -    | 10000               | -             | 50000       | -             | 1000 |
| BLA31                | 3.4        | 1.8  | 1.1 max.  | -    | 4000                | -             | 10000       | -             | 1000 |

(in mm)

## ■ Minimum Quantity and Dimensions of 12mm Width Embossed Tape

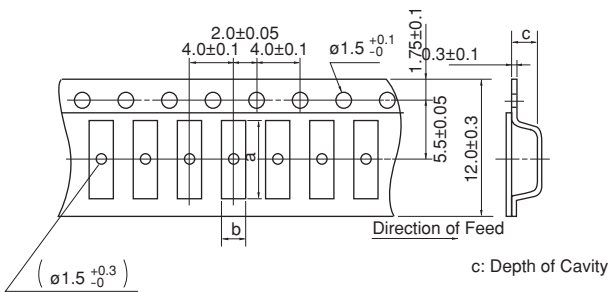

Dimension of the cavity is measured at the bottom side.

| Part Number | Dimensions |     |      | Minimum Qty. (pcs.) |             |      |
|-------------|------------|-----|------|---------------------|-------------|------|
|             | a          | b   | c    | ø180mm Reel         | ø330mm Reel | Bulk |
| BLM41       | 4.8        | 1.9 | 1.75 | 2500                | 8000        | 1000 |

(in mm)

"Minimum Quantity" means the number of units of each delivery or order. The quantity should be an integral multiple of the "Minimum Quantity."

△Note • Please read rating and △CAUTION (for storage, operating, rating, soldering, mounting and handling) in this catalog to prevent smoking and/or burning, etc.  
• This catalog has only typical specifications. Therefore, please approve our product specifications or transact the approval sheet for product specifications before ordering.

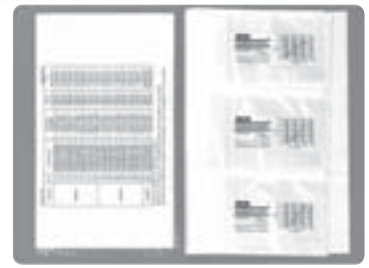

●EKEMBL03AL-KIT (Chip Ferrite Beads)

| No. | Part Number   | Quantity (pcs.) | Impedance typ. (at 100MHz, 20 degrees C) | Rated Current (mA) | DC Resistance (Ω) max. |
|-----|---------------|-----------------|--|--------------------|------------------------|
| 1   | BLM02AX100SN1 | 20              | 10Ω±5Ω                                   | 750                | 0.07                   |
| 2   | BLM02AX700SN1 | 20              | 70Ω±25%                                  | 300                | 0.4                    |
| 3   | BLM02AX121SN1 | 20              | 120Ω±25%                                 | 250                | 0.5                    |
| 4   | BLM03AG100SN1 | 20              | 10Ω (Typ.)                               | 500                | 0.1                    |
| 5   | BLM03AG700SN1 | 20              | 70Ω (Typ.)                               | 200                | 0.4                    |
| 6   | BLM03AG800SN1 | 20              | 80Ω±25%                                  | 200                | 0.4                    |
| 7   | BLM03AG121SN1 | 20              | 120Ω±25%                                 | 200                | 0.5                    |
| 8   | BLM03AG241SN1 | 20              | 240Ω±25%                                 | 200                | 0.8                    |
| 9   | BLM03AG601SN1 | 20              | 600Ω±25%                                 | 100                | 1.5                    |
| 10  | BLM03AG102SN1 | 20              | 1000Ω±25%                                | 100                | 2.5                    |
| 11  | BLM03AX100SN1 | 20              | 10Ω (Typ.)                               | 1000               | 0.05                   |
| 12  | BLM03AX800SN1 | 20              | 80Ω±25%                                  | 500                | 0.18                   |
| 13  | BLM03AX121SN1 | 20              | 120Ω±25%                                 | 450                | 0.23                   |
| 14  | BLM03AX241SN1 | 20              | 240Ω±25%                                 | 350                | 0.38                   |
| 15  | BLM03AX601SN1 | 20              | 600Ω±25%                                 | 250                | 0.85                   |
| 16  | BLM03AX102SN1 | 20              | 1000Ω±25%                                | 200                | 1.25                   |
| 17  | BLM03BB100SN1 | 20              | 10Ω±25%                                  | 300                | 0.4                    |
| 18  | BLM03BB220SN1 | 20              | 22Ω±25%                                  | 200                | 0.5                    |
| 19  | BLM03BB470SN1 | 20              | 47Ω±25%                                  | 200                | 0.7                    |
| 20  | BLM03BB750SN1 | 20              | 75Ω±25%                                  | 200                | 1.0                    |
| 21  | BLM03BB121SN1 | 20              | 120Ω±25%                                 | 100                | 1.5                    |
| 22  | BLM03BD750SN1 | 20              | 75Ω±25%                                  | 300                | 0.4                    |
| 23  | BLM03BD121SN1 | 20              | 120Ω±25%                                 | 250                | 0.5                    |
| 24  | BLM03BD241SN1 | 20              | 240Ω±25%                                 | 200                | 0.8                    |
| 25  | BLM03BD471SN1 | 20              | 470Ω±25%                                 | 215                | 1.5                    |
| 26  | BLM03BD601SN1 | 20              | 600Ω±25%                                 | 200                | 1.7                    |
| 27  | BLM03BC330SN1 | 20              | 33Ω±25%                                  | 150                | 0.85                   |
| 28  | BLM03BC560SN1 | 20              | 56Ω±25%                                  | 100                | 1.05                   |
| 29  | BLM03BC800SN1 | 20              | 80Ω±25%                                  | 100                | 1.40                   |
| 30  | BLM03EB250SN1 | 20              | 25Ω±25%                                  | 600                | 0.26                   |
| 31  | BLM03EB500SN1 | 20              | 50Ω±25%                                  | 400                | 0.58                   |
| 32  | BLM03HG601SN1 | 20              | 600Ω±25%                                 | 150                | 1.6                    |
| 33  | BLM03HG102SN1 | 20              | 1000Ω±25%                                | 125                | 2.6                    |
| 34  | BLM03HB191SN1 | 20              | 190Ω±25%                                 | 150                | 2.0                    |
| 35  | BLM03HD331SN1 | 20              | 330Ω±25%                                 | 200                | 1.0                    |
| 36  | BLM03HD471SN1 | 20              | 470Ω±25%                                 | 175                | 1.3                    |
| 37  | BLM03HD601SN1 | 20              | 600Ω±25%                                 | 150                | 1.7                    |
| 38  | BLM03HD102SN1 | 20              | 1000Ω±25%                                | 120                | 2.9                    |
| 39  | BLM03PG220SN1 | 20              | 22Ω±25%                                  | 900                | 0.065                  |
| 40  | BLM03PG330SN1 | 20              | 33Ω±25%                                  | 750                | 0.090                  |
| 41  | BLM03PX220SN1 | 20              | 22Ω±25%                                  | 1800               | 0.040                  |
| 42  | BLM03PX330SN1 | 20              | 33Ω±25%                                  | 1500               | 0.055                  |
| 43  | BLM03PX800SN1 | 20              | 80Ω±25%                                  | 1000               | 0.130                  |

●EKEMBL15AR-KIT (Chip Ferrite Beads)

| No. | Part Number   | Quantity (pcs.) | Impedance typ. (at 100MHz, 20 degrees C) | Rated Current (mA) | DC Resistance (Ω) max. |
|-----|---------------|-----------------|--|--------------------|------------------------|
| 1   | BLM15AG100SN1 | 20              | 10Ω (Typ.)                               | 1000               | 0.025                  |
| 2   | BLM15AG700SN1 | 20              | 70Ω (Typ.)                               | 600                | 0.15                   |
| 3   | BLM15AG121SN1 | 20              | 120Ω±25%                                 | 550                | 0.19                   |
| 4   | BLM15AG221SN1 | 20              | 220Ω±25%                                 | 450                | 0.29                   |
| 5   | BLM15AG601SN1 | 20              | 600Ω±25%                                 | 300                | 0.52                   |
| 6   | BLM15AG102SN1 | 20              | 1000Ω±25%                                | 300                | 0.65                   |
| 7   | BLM15AX100SN1 | 20              | 10Ω±5Ω                                   | 1740               | 0.015                  |
| 8   | BLM15AX300SN1 | 20              | 30Ω±25%                                  | 1100               | 0.06                   |

Continued on the following page.

△Note • Please read rating and △CAUTION (for storage, operating, rating, soldering, mounting and handling) in this catalog to prevent smoking and/or burning, etc.  
• This catalog has only typical specifications. Therefore, please approve our product specifications or transact the approval sheet for product specifications before ordering.

Continued from the preceding page.

| No. | Part Number   | Quantity (pcs.) | Impedance typ. (at 100MHz, 20 degrees C) | Rated Current (mA) | DC Resistance (Ω) max. |
|-----|---------------|-----------------|--|--------------------|------------------------|
| 9   | BLM15AX700SN1 | 20              | 70Ω±25%                                  | 780                | 0.10                   |
| 10  | BLM15AX121SN1 | 20              | 120Ω±25%                                 | 700                | 0.13                   |
| 11  | BLM15AX221SN1 | 20              | 220Ω±25%                                 | 600                | 0.18                   |
| 12  | BLM15AX601SN1 | 20              | 600Ω±25%                                 | 500                | 0.34                   |
| 13  | BLM15AX102SN1 | 20              | 1000Ω±25%                                | 350                | 0.49                   |
| 14  | BLM15BA050SN1 | 20              | 5Ω±25%                                   | 300                | 0.10                   |
| 15  | BLM15BA100SN1 | 20              | 10Ω±25%                                  | 300                | 0.20                   |
| 16  | BLM15BA220SN1 | 20              | 22Ω±25%                                  | 300                | 0.30                   |
| 17  | BLM15BA330SN1 | 20              | 33Ω±25%                                  | 300                | 0.40                   |
| 18  | BLM15BA470SN1 | 20              | 47Ω±25%                                  | 200                | 0.60                   |
| 19  | BLM15BA750SN1 | 20              | 75Ω±25%                                  | 200                | 0.80                   |
| 20  | BLM15BB050SN1 | 20              | 5Ω±25%                                   | 500                | 0.08                   |
| 21  | BLM15BB100SN1 | 20              | 10Ω±25%                                  | 300                | 0.10                   |
| 22  | BLM15BB220SN1 | 20              | 22Ω±25%                                  | 300                | 0.20                   |
| 23  | BLM15BB470SN1 | 20              | 47Ω±25%                                  | 300                | 0.35                   |
| 24  | BLM15BB750SN1 | 20              | 75Ω±25%                                  | 300                | 0.40                   |
| 25  | BLM15BB121SN1 | 20              | 120Ω±25%                                 | 300                | 0.55                   |
| 26  | BLM15BB221SN1 | 20              | 220Ω±25%                                 | 200                | 0.80                   |
| 27  | BLM15BC121SN1 | 20              | 120Ω±25%                                 | 350                | 0.45                   |
| 28  | BLM15BC241SN1 | 20              | 240Ω±25%                                 | 250                | 0.70                   |
| 29  | BLM15BD750SN1 | 20              | 75Ω±25%                                  | 300                | 0.20                   |
| 30  | BLM15BD121SN1 | 20              | 120Ω±25%                                 | 300                | 0.30                   |
| 31  | BLM15BD221SN1 | 20              | 220Ω±25%                                 | 300                | 0.40                   |
| 32  | BLM15BD471SN1 | 20              | 470Ω±25%                                 | 200                | 0.60                   |
| 33  | BLM15BD601SN1 | 20              | 600Ω±25%                                 | 200                | 0.65                   |
| 34  | BLM15BD102SN1 | 20              | 1000Ω±25%                                | 200                | 0.90                   |
| 35  | BLM15BD182SN1 | 20              | 1800Ω±25%                                | 100                | 1.40                   |
| 36  | BLM15BX750SN1 | 20              | 75Ω±25%                                  | 600                | 0.15                   |
| 37  | BLM15BX121SN1 | 20              | 120Ω±25%                                 | 600                | 0.17                   |
| 38  | BLM15BX221SN1 | 20              | 220Ω±25%                                 | 450                | 0.27                   |
| 39  | BLM15BX471SN1 | 20              | 470Ω±25%                                 | 350                | 0.41                   |
| 40  | BLM15BX601SN1 | 20              | 600Ω±25%                                 | 350                | 0.46                   |
| 41  | BLM15BX102SN1 | 20              | 1000Ω±25%                                | 300                | 0.65                   |
| 42  | BLM15BX182SN1 | 20              | 1800Ω±25%                                | 250                | 0.90                   |
| 43  | BLM15HD601SN1 | 20              | 600Ω±25%                                 | 300                | 0.85                   |
| 44  | BLM15HD102SN1 | 20              | 1000Ω±25%                                | 250                | 1.25                   |
| 45  | BLM15HD182SN1 | 20              | 1800Ω±25%                                | 200                | 2.20                   |
| 46  | BLM15HG601SN1 | 20              | 600Ω±25%                                 | 300                | 0.70                   |
| 47  | BLM15HG102SN1 | 20              | 1000Ω±25%                                | 250                | 1.10                   |
| 48  | BLM15HB121SN1 | 20              | 120Ω±25%                                 | 300                | 0.70                   |
| 49  | BLM15HB221SN1 | 20              | 220Ω±25%                                 | 250                | 1.00                   |
| 50  | BLM15EG121SN1 | 20              | 120Ω±25%                                 | 1500               | 0.095                  |
| 51  | BLM15EG221SN1 | 20              | 220Ω±25%                                 | 700                | 0.28                   |
| 52  | BLM15GG221SN1 | 20              | 220Ω±25%                                 | 300                | 0.70                   |
| 53  | BLM15GG471SN1 | 20              | 470Ω±25%                                 | 200                | 1.30                   |
| 54  | BLM15GA750SN1 | 20              | 75Ω±25%                                  | 200                | 1.30                   |
| 55  | BLM15PG100SN1 | 20              | 10Ω (Typ.)                               | 1000               | 0.025                  |
| 56  | BLM15PD300SN1 | 20              | 30Ω±25%                                  | 2200               | 0.035                  |
| 57  | BLM15PD600SN1 | 20              | 60Ω±25%                                  | 1700               | 0.06                   |
| 58  | BLM15PD800SN1 | 20              | 80Ω±25%                                  | 1500               | 0.07                   |
| 59  | BLM15PD121SN1 | 20              | 120Ω±25%                                 | 1300               | 0.09                   |
| 60  | BLM15PX330SN1 | 20              | 33Ω±25%                                  | 3000               | 0.022                  |
| 61  | BLM15PX600SN1 | 20              | 60Ω±25%                                  | 2500               | 0.032                  |
| 62  | BLM15PX800SN1 | 20              | 80Ω±25%                                  | 2300               | 0.038                  |
| 63  | BLM15PX121SN1 | 20              | 120Ω±25%                                 | 2000               | 0.055                  |
| 64  | BLM15PX181SN1 | 20              | 180Ω±25%                                 | 1500               | 0.090                  |
| 65  | BLM15PX221SN1 | 20              | 220Ω±25%                                 | 1400               | 0.10                   |
| 66  | BLM15PX331SN1 | 20              | 330Ω±25%                                 | 1200               | 0.15                   |
| 67  | BLM15PX471SN1 | 20              | 470Ω±25%                                 | 1000               | 0.20                   |
| 68  | BLM15PX601SN1 | 20              | 600Ω±25%                                 | 900                | 0.23                   |

△Note • Please read rating and △CAUTION (for storage, operating, rating, soldering, mounting and handling) in this catalog to prevent smoking and/or burning, etc.  
 • This catalog has only typical specifications. Therefore, please approve our product specifications or transact the approval sheet for product specifications before ordering.

Design Kits  
Chip Ferrite Bead

Chip EMIFIL®

Chip Common Mode Choke Coil

Block Type EMIFIL®

Microwave Absorber

## ●EKEMBL18AJ-KIT (Chip Ferrite Beads)

| No. | Part Number   | Quantity (pcs.) | Impedance typ. (at 100MHz, 20 degrees C) | Rated Current (mA) | DC Resistance (Ω) max. |
|-----|---------------|-----------------|--|--------------------|------------------------|
| 1   | BLM18AG121SN1 | 20              | 120Ω±25%                                 | 500                | 0.18                   |
| 2   | BLM18AG151SN1 | 20              | 150Ω±25%                                 | 500                | 0.25                   |
| 3   | BLM18AG221SN1 | 20              | 220Ω±25%                                 | 500                | 0.25                   |
| 4   | BLM18AG331SN1 | 20              | 330Ω±25%                                 | 500                | 0.30                   |
| 5   | BLM18AG471SN1 | 20              | 470Ω±25%                                 | 500                | 0.35                   |
| 6   | BLM18AG601SN1 | 20              | 600Ω±25%                                 | 500                | 0.38                   |
| 7   | BLM18AG102SN1 | 20              | 1000Ω±25%                                | 400                | 0.50                   |
| 8   | BLM18BA050SN1 | 20              | 5Ω±25%                                   | 500                | 0.20                   |
| 9   | BLM18BA100SN1 | 20              | 10Ω±25%                                  | 500                | 0.25                   |
| 10  | BLM18BA470SN1 | 20              | 47Ω±25%                                  | 300                | 0.55                   |
| 11  | BLM18BA750SN1 | 20              | 75Ω±25%                                  | 300                | 0.70                   |
| 12  | BLM18BA121SN1 | 20              | 120Ω±25%                                 | 200                | 0.90                   |
| 13  | BLM18BB050SN1 | 20              | 5Ω±25%                                   | 700                | 0.05                   |
| 14  | BLM18BB100SN1 | 20              | 10Ω±25%                                  | 700                | 0.10                   |
| 15  | BLM18BB220SN1 | 20              | 22Ω±25%                                  | 600                | 0.20                   |
| 16  | BLM18BB470SN1 | 20              | 47Ω±25%                                  | 550                | 0.25                   |
| 17  | BLM18BB600SN1 | 20              | 60Ω±25%                                  | 550                | 0.25                   |
| 18  | BLM18BB750SN1 | 20              | 75Ω±25%                                  | 500                | 0.30                   |
| 19  | BLM18BB121SN1 | 20              | 120Ω±25%                                 | 500                | 0.30                   |
| 20  | BLM18BB151SN1 | 20              | 150Ω±25%                                 | 450                | 0.37                   |
| 21  | BLM18BB221SN1 | 20              | 220Ω±25%                                 | 450                | 0.45                   |
| 22  | BLM18BB331SN1 | 20              | 330Ω±25%                                 | 400                | 0.58                   |
| 23  | BLM18BB471SN1 | 20              | 470Ω±25%                                 | 300                | 0.85                   |
| 24  | BLM18BD470SN1 | 20              | 47Ω±25%                                  | 500                | 0.30                   |
| 25  | BLM18BD121SN1 | 20              | 120Ω±25%                                 | 200                | 0.40                   |
| 26  | BLM18BD151SN1 | 20              | 150Ω±25%                                 | 200                | 0.40                   |
| 27  | BLM18BD221SN1 | 20              | 220Ω±25%                                 | 200                | 0.45                   |
| 28  | BLM18BD331SN1 | 20              | 330Ω±25%                                 | 200                | 0.50                   |
| 29  | BLM18BD421SN1 | 20              | 420Ω±25%                                 | 200                | 0.55                   |
| 30  | BLM18BD471SN1 | 20              | 470Ω±25%                                 | 200                | 0.55                   |
| 31  | BLM18BD601SN1 | 20              | 600Ω±25%                                 | 200                | 0.65                   |
| 32  | BLM18BD102SN1 | 20              | 1000Ω±25%                                | 100                | 0.85                   |
| 33  | BLM18BD152SN1 | 20              | 1500Ω±25%                                | 50                 | 1.20                   |
| 34  | BLM18BD182SN1 | 20              | 1800Ω±25%                                | 50                 | 1.50                   |
| 35  | BLM18BD222SN1 | 20              | 2200Ω±25%                                | 50                 | 1.50                   |
| 36  | BLM18BD252SN1 | 20              | 2500Ω±25%                                | 50                 | 1.50                   |
| 37  | BLM18PG300SN1 | 20              | 30Ω (Typ.)                               | 1000               | 0.05                   |
| 38  | BLM18PG330SN1 | 20              | 33Ω±25%                                  | 3000               | 0.025                  |
| 39  | BLM18PG600SN1 | 20              | 60Ω (Typ.)                               | 500                | 0.10                   |
| 40  | BLM18PG121SN1 | 20              | 120Ω±25%                                 | 2000               | 0.05                   |
| 41  | BLM18PG181SN1 | 20              | 180Ω±25%                                 | 1500               | 0.09                   |
| 42  | BLM18PG221SN1 | 20              | 220Ω±25%                                 | 1400               | 0.10                   |
| 43  | BLM18PG331SN1 | 20              | 330Ω±25%                                 | 1200               | 0.15                   |
| 44  | BLM18PG471SN1 | 20              | 470Ω±25%                                 | 1000               | 0.20                   |
| 45  | BLM18KG260TN1 | 20              | 26Ω±25%                                  | 6000               | 0.007                  |
| 46  | BLM18KG300TN1 | 20              | 30Ω±25%                                  | 5000               | 0.010                  |
| 47  | BLM18KG700TN1 | 20              | 70Ω±25%                                  | 3500               | 0.022                  |
| 48  | BLM18KG101TN1 | 20              | 100Ω±25%                                 | 3000               | 0.030                  |
| 49  | BLM18KG121TN1 | 20              | 120Ω±25%                                 | 3000               | 0.030                  |
| 50  | BLM18KG221SN1 | 20              | 220Ω±25%                                 | 2200               | 0.050                  |
| 51  | BLM18KG331SN1 | 20              | 330Ω±25%                                 | 1700               | 0.080                  |
| 52  | BLM18KG471SN1 | 20              | 470Ω±25%                                 | 1500               | 0.130                  |
| 53  | BLM18KG601SN1 | 20              | 600Ω±25%                                 | 1300               | 0.150                  |
| 54  | BLM18SG260TN1 | 20              | 26Ω±25%                                  | 6000               | 0.007                  |
| 55  | BLM18SG700TN1 | 20              | 70Ω±25%                                  | 4000               | 0.020                  |
| 56  | BLM18SG121TN1 | 20              | 120Ω±25%                                 | 3000               | 0.025                  |
| 57  | BLM18SG221TN1 | 20              | 220Ω±25%                                 | 2500               | 0.040                  |
| 58  | BLM18SG331TN1 | 20              | 330Ω±25%                                 | 1500               | 0.070                  |

## ●EKEMBL8GAB-KIT (Chip Ferrite Beads / for High Frequency Type)

| No. | Part Number   | Quantity (pcs.) | Impedance (at 100MHz, 20 degrees C) | Impedance (at 1GHz, 20 degrees C) | Rated Current (mA) | DC Resistance (Ω) max. |
|-----|---------------|-----------------|-------------------------------------|-----------------------------------|--------------------|------------------------|
| 1   | BLM18HG471SN1 | 20              | 470Ω±25%                            | 600Ω (Typ.)                       | 200                | 0.85                   |
| 2   | BLM18HG601SN1 | 20              | 600Ω±25%                            | 700Ω (Typ.)                       | 200                | 1.00                   |
| 3   | BLM18HG102SN1 | 20              | 1000Ω±25%                           | 1000Ω (Typ.)                      | 100                | 1.60                   |

Continued on the following page. 

⚠Note • Please read rating and ⚠CAUTION (for storage, operating, rating, soldering, mounting and handling) in this catalog to prevent smoking and/or burning, etc.  
 • This catalog has only typical specifications. Therefore, please approve our product specifications or transact the approval sheet for product specifications before ordering.

Continued from the preceding page.

| No. | Part Number   | Quantity (pcs.) | Impedance (at 100MHz, 20 degrees C) | Impedance (at 1GHz, 20 degrees C) | Rated Current (mA) | DC Resistance (Ω) max. |
|-----|---------------|-----------------|-------------------------------------|-----------------------------------|--------------------|------------------------|
| 4   | BLM18HB121SN1 | 20              | 120Ω±25%                            | 500Ω±40%                          | 200                | 0.50                   |
| 5   | BLM18HB221SN1 | 20              | 220Ω±25%                            | 1100Ω±40%                         | 100                | 0.80                   |
| 6   | BLM18HB331SN1 | 20              | 330Ω±25%                            | 1600Ω±40%                         | 50                 | 1.20                   |
| 7   | BLM18HD471SN1 | 20              | 470Ω±25%                            | 1000Ω (Typ.)                      | 100                | 1.20                   |
| 8   | BLM18HD601SN1 | 20              | 600Ω±25%                            | 1200Ω (Typ.)                      | 100                | 1.50                   |
| 9   | BLM18HD102SN1 | 20              | 1000Ω±25%                           | 1700Ω (Typ.)                      | 50                 | 1.80                   |
| 10  | BLM18HE601SN1 | 20              | 600Ω±25%                            | 600Ω (Typ.)                       | 800                | 0.25                   |
| 11  | BLM18HE102SN1 | 20              | 1000Ω±25%                           | 1000Ω (Typ.)                      | 600                | 0.35                   |
| 12  | BLM18HE152SN1 | 20              | 1500Ω±25%                           | 1500Ω (Typ.)                      | 500                | 0.50                   |
| 13  | BLM18HK331SN1 | 20              | 330Ω±25%                            | 400Ω (Typ.)                       | 200                | 0.50                   |
| 14  | BLM18HK471SN1 | 20              | 470Ω±25%                            | 600Ω (Typ.)                       | 200                | 0.70                   |
| 15  | BLM18HK601SN1 | 20              | 600Ω±25%                            | 700Ω (Typ.)                       | 100                | 0.90                   |
| 16  | BLM18HK102SN1 | 20              | 1000Ω±25%                           | 1200Ω (Typ.)                      | 50                 | 1.50                   |
| 17  | BLM18EG101TN1 | 20              | 100Ω±25%                            | 140Ω (Typ.)                       | 2000               | 0.045                  |
| 18  | BLM18EG121SN1 | 20              | 120Ω±25%                            | 145Ω (Typ.)                       | 2000               | 0.04                   |
| 19  | BLM18EG221TN1 | 20              | 220Ω±25%                            | 300Ω (Typ.)                       | 1000               | 0.15                   |
| 20  | BLM18EG221SN1 | 20              | 220Ω±25%                            | 260Ω (Typ.)                       | 2000               | 0.05                   |
| 21  | BLM18EG331TN1 | 20              | 330Ω±25%                            | 450Ω (Typ.)                       | 500                | 0.21                   |
| 22  | BLM18EG391TN1 | 20              | 390Ω±25%                            | 520Ω (Typ.)                       | 500                | 0.30                   |
| 23  | BLM18EG471SN1 | 20              | 470Ω±25%                            | 550Ω (Typ.)                       | 500                | 0.21                   |
| 24  | BLM18EG601SN1 | 20              | 600Ω±25%                            | 700Ω (Typ.)                       | 500                | 0.35                   |
| 25  | BLM18GG471SN1 | 20              | 470Ω±25%                            | 1800Ω±30%                         | 200                | 1.30                   |

●EKEMBL21AF-KIT (Chip Ferrite Beads / for Large-current P Type)

| No. | Part Number   | Quantity (pcs.) | Impedance typ. (at 100MHz, 20 degrees C) | Rated Current (mA) | DC Resistance (Ω) max. |
|-----|---------------|-----------------|--|--------------------|------------------------|
| 1   | BLM21AG121SN1 | 20              | 120Ω±25%                                 | 800                | 0.10                   |
| 2   | BLM21AG151SN1 | 20              | 150Ω±25%                                 | 800                | 0.10                   |
| 3   | BLM21AG221SN1 | 20              | 220Ω±25%                                 | 800                | 0.13                   |
| 4   | BLM21AG331SN1 | 20              | 330Ω±25%                                 | 700                | 0.16                   |
| 5   | BLM21AG471SN1 | 20              | 470Ω±25%                                 | 700                | 0.19                   |
| 6   | BLM21AG601SN1 | 20              | 600Ω±25%                                 | 600                | 0.21                   |
| 7   | BLM21AG102SN1 | 20              | 1000Ω±25%                                | 500                | 0.28                   |
| 8   | BLM21BB050SN1 | 20              | 5Ω±25%                                   | 1000               | 0.02                   |
| 9   | BLM21BB600SN1 | 20              | 60Ω±25%                                  | 800                | 0.13                   |
| 10  | BLM21BB750SN1 | 20              | 75Ω±25%                                  | 700                | 0.16                   |
| 11  | BLM21BB121SN1 | 20              | 120Ω±25%                                 | 600                | 0.19                   |
| 12  | BLM21BB221SN1 | 20              | 220Ω±25%                                 | 500                | 0.26                   |
| 13  | BLM21BB331SN1 | 20              | 330Ω±25%                                 | 400                | 0.33                   |
| 14  | BLM21BB471SN1 | 20              | 470Ω±25%                                 | 400                | 0.40                   |
| 15  | BLM21BD121SN1 | 20              | 120Ω±25%                                 | 200                | 0.25                   |
| 16  | BLM21BD221SN1 | 20              | 220Ω±25%                                 | 200                | 0.25                   |
| 17  | BLM21BD421SN1 | 20              | 420Ω±25%                                 | 200                | 0.30                   |
| 18  | BLM21BD471SN1 | 20              | 470Ω±25%                                 | 200                | 0.35                   |
| 19  | BLM21BD601SN1 | 20              | 600Ω±25%                                 | 200                | 0.35                   |
| 20  | BLM21BD102SN1 | 20              | 1000Ω±25%                                | 200                | 0.40                   |
| 21  | BLM21BD152SN1 | 20              | 1500Ω±25%                                | 200                | 0.45                   |
| 22  | BLM21BD182SN1 | 20              | 1800Ω±25%                                | 200                | 0.50                   |
| 23  | BLM21BD222SN1 | 20              | 2250Ω (Typ.)                             | 200                | 0.60                   |
| 24  | BLM21BD222TN1 | 20              | 2200Ω±25%                                | 200                | 0.60                   |
| 25  | BLM21BD272SN1 | 20              | 2700Ω±25%                                | 200                | 0.80                   |
| 26  | BLM21PG220SN1 | 20              | 22Ω±25%                                  | 6000               | 0.009                  |
| 27  | BLM21PG300SN1 | 20              | 30Ω (Typ.)                               | 4000               | 0.014                  |
| 28  | BLM21PG600SN1 | 20              | 60Ω±25%                                  | 3500               | 0.02                   |
| 29  | BLM21PG121SN1 | 20              | 120Ω±25%                                 | 3000               | 0.03                   |
| 30  | BLM21PG221SN1 | 20              | 220Ω±25%                                 | 2000               | 0.045                  |
| 31  | BLM21PG331SN1 | 20              | 330Ω±25%                                 | 1500               | 0.07                   |
| 32  | BLM31PG330SN1 | 20              | 33Ω±25%                                  | 6000               | 0.009                  |
| 33  | BLM31PG500SN1 | 20              | 50Ω (Typ.)                               | 3500               | 0.015                  |
| 34  | BLM31PG121SN1 | 20              | 120Ω±25%                                 | 3500               | 0.02                   |
| 35  | BLM31PG391SN1 | 20              | 390Ω±25%                                 | 2000               | 0.05                   |
| 36  | BLM31PG601SN1 | 20              | 600Ω±25%                                 | 1500               | 0.08                   |
| 37  | BLM41PG600SN1 | 20              | 60Ω (Typ.)                               | 6000               | 0.009                  |
| 38  | BLM41PG750SN1 | 20              | 75Ω (Typ.)                               | 3500               | 0.015                  |
| 39  | BLM41PG181SN1 | 20              | 180Ω±25%                                 | 3500               | 0.02                   |

Continued on the following page.

△Note • Please read rating and △CAUTION (for storage, operating, rating, soldering, mounting and handling) in this catalog to prevent smoking and/or burning, etc.  
 • This catalog has only typical specifications. Therefore, please approve our product specifications or transact the approval sheet for product specifications before ordering.

Continued from the preceding page.

| No. | Part Number          | Quantity (pcs.) | Impedance typ. (at 100MHz, 20 degrees C) | Rated Current (mA) | DC Resistance ( $\Omega$ ) max. |
|-----|----------------------|-----------------|--|--------------------|---------------------------------|
| 40  | <b>BLM41PG471SN1</b> | 20              | 470 $\Omega$ ±25%                        | 2000               | 0.05                            |
| 41  | <b>BLM41PG102SN1</b> | 20              | 1000 $\Omega$ ±25%                       | 1500               | 0.09                            |

⚠Note • Please read rating and ⚠CAUTION (for storage, operating, rating, soldering, mounting and handling) in this catalog to prevent smoking and/or burning, etc.  
• This catalog has only typical specifications. Therefore, please approve our product specifications or transact the approval sheet for product specifications before ordering.

# Memo



# NF<sub>□</sub>

## Chip EMIFIL<sup>®</sup>

|                              |     |
|------------------------------|-----|
| Series Introduction .....    | 112 |
| Part Numbering .....         | 114 |
| Series Line Up .....         | 117 |
| Product Detail .....         | 121 |
| ⚠Caution/Notice .....        | 154 |
| Soldering and Mounting ..... | 156 |
| Packaging .....              | 163 |
| Design Kits .....            | 165 |

Chip Ferrite Bead

Chip EMIFIL<sup>®</sup>

Chip Common Mode Choke Coil

Block Type EMIFIL<sup>®</sup>

Microwave Absorber

⚠Note • Please read rating and ⚠CAUTION (for storage, operating, rating, soldering, mounting and handling) in this catalog to prevent smoking and/or burning, etc.  
• This catalog has only typical specifications. Therefore, please approve our product specifications or transact the approval sheet for product specifications before ordering.

# NF□ Series Introduction

Chip Ferrite Bead

Chip EMIFIL®

Chip Common Mode Choke Coil

Block Type EMIFIL®

Microwave Absorber

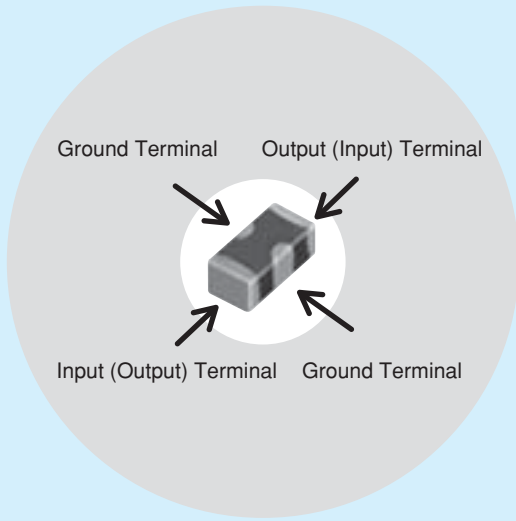

## Example of 3-Terminal Capacitor Structure

Chip 3-terminal capacitor is a chip-shaped 3-terminal capacitor designed for noise suppression. Its inner structure, like a feed-through capacitor, makes its ground impedance quite low. Owing to this structure, the 3-terminal capacitor has a good noise suppression effect at a high frequency range up to several hundred MHz.

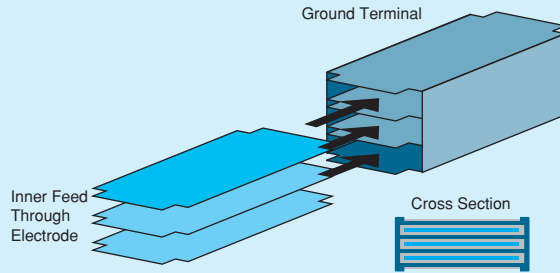

| Series   | Equivalent Circuit | Part Number  |
|--|--------------------|--|
| <b>NFM Series</b><br>(3-terminal capacitor)                      |                    | <b>NFM18CC</b>                                     |
|  |                    | <b>NFM21CC</b>                                     |
|  |                    | <b>NFM18PC</b>                                     |
|  |                    | <b>NFM18PS</b>                                     |
|  |                    | <b>NFM21PC</b>                                     |
| <b>NFL / NFW Series</b><br>(LC filter)                           |                    | <b>NFL15ST</b>                                     |
|  |                    | <b>NFL18ST</b>                                     |
|  |                    | <b>NFL18SP</b><br><b>NFL21SP</b><br><b>NFW31SP</b> |
| <b>NFA Series</b><br>(RC filter)                                 |                    | <b>NFA21SL</b>                                     |
|  |                    | <b>NFA18SL</b>                                     |
|  |                    | <b>NFA18SD</b>                                     |
| <b>NFR Series</b><br>(RC filter)                                 |                    | <b>NFR21GD</b>                                     |
|  |                    | <b>NFA31GD</b>                                     |
| <b>NFE Series</b><br>(Feed through capacitor with ferrite cores) |                    | <b>NFE31PT</b>                                     |
|  |                    | <b>NFE61PT</b>                                     |

△Note • Please read rating and △CAUTION (for storage, operating, rating, soldering, mounting and handling) in this catalog to prevent smoking and/or burning, etc.  
• This catalog has only typical specifications. Therefore, please approve our product specifications or transact the approval sheet for product specifications before ordering.

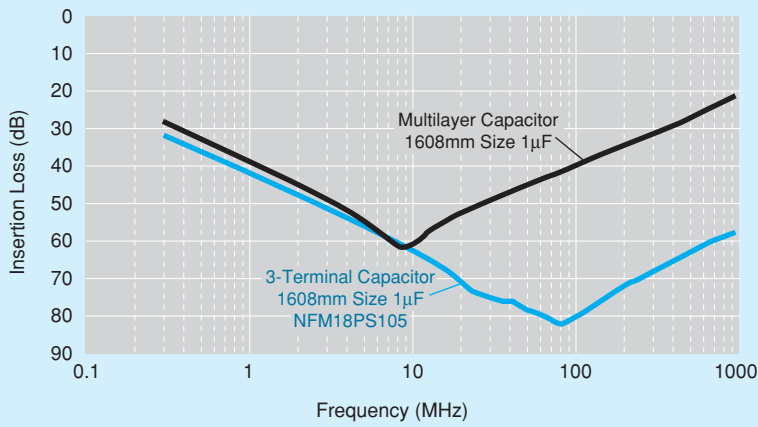

| Insertion Loss Sample | Features   | Classification |   | Applications   | Example  |
|-----------------------|--|----------------|---|--|--|
|                       |  | Code           | Description   |  |  |
|                       | Standard of 3-terminal capacitor   | <b>NFM_CC</b>  | Standard type with varied capacitance                           | Noise suppression in low speed signal lines            | · Low speed interface lines<br>· Sensor  |
|                       |  | <b>NFM_PC</b>  | Meet large current, high capacitance available, for power lines | Noise suppression in power lines                       | · Individual IC power lines  |
|                       | Sharp insertion loss curve enables low damage to signal waveform                           | <b>NFL_ST</b>  | T-type filter, effective in low impedance circuits              | Noise suppression in high speed signal lines           | · High speed interface lines<br>· Bus lines<br>· LCD lines<br>· Camera I/Fs<br>· High speed analog lines<br>· RGB / D terminal |
|                       |  | <b>NFL_SP</b>  | $\pi$ -type filter, effective in high impedance circuits        |  |  |
|                       |  | <b>NFW_SP</b>  | $\pi$ -type filter, designed for low impedance circuits         |  |  |
|                       |  | <b>NFA_SL</b>  | 4-line array, suitable for bus lines or flat cables             |  |  |
|                       | Limit noise using resistor, also loop back to ground                                       |                |   | Noise suppression in signal line with unstable ground  | · Interface lines<br>· Clock lines   |
|                       | Meets large current, good high frequency performance because of its feed through structure |                |   | Noise suppression in power lines / low impedance lines | · Various power lines<br>· Sensor  |

△Note • Please read rating and △CAUTION (for storage, operating, rating, soldering, mounting and handling) in this catalog to prevent smoking and/or burning, etc.  
• This catalog has only typical specifications. Therefore, please approve our product specifications or transact the approval sheet for product specifications before ordering.

# NF   Chip EMIFIL<sup>®</sup> Part Numbering

## Capacitor

(Part Number)

|           |          |           |           |            |          |           |          |          |
|-----------|----------|-----------|-----------|------------|----------|-----------|----------|----------|
| <b>NF</b> | <b>M</b> | <b>3D</b> | <b>CC</b> | <b>102</b> | <b>R</b> | <b>1H</b> | <b>3</b> | <b>L</b> |
| ①         | ②        | ③         | ④         | ⑤          | ⑥        | ⑦         | ⑧        | ⑨        |

\*NFA□□SL/SD Series, please refer to p.116 (LC Combined (2)).

\*NFA□□GD Series, please refer to p.116 (RC Combined).

### ① Product ID

| Product ID |                          |
|------------|--------------------------|
| <b>NF</b>  | Chip EMIFIL <sup>®</sup> |

### ② Structure

| Code     | Structure            |
|----------|----------------------|
| <b>M</b> | Capacitor Type       |
| <b>A</b> | Capacitor Array Type |

### ③ Dimensions (L×W)

| Code      | Dimensions (L×W) | EIA  |
|-----------|------------------|------|
| <b>15</b> | 1.0×0.5mm        | 0402 |
| <b>18</b> | 1.6×0.8mm        | 0603 |
| <b>21</b> | 2.0×1.25mm       | 0805 |
| <b>3D</b> | 3.2×1.25mm       | 1205 |
| <b>31</b> | 3.2×1.6mm        | 1206 |
| <b>41</b> | 4.5×1.6mm        | 1806 |

### ④ Features

| Code      | Features                                   |
|-----------|--|
| <b>CC</b> | Capacitor Type for Signal Lines            |
| <b>PC</b> | Capacitor Type for Large Current           |
| <b>PS</b> | High Insertion Loss Type for Large Current |
| <b>KC</b> | Capacitor Type for Very Large Current      |

### ⑤ Capacitance

Expressed by three figures. The unit is in pico-farad (pF). The first and second figures are significant digits, and the third figure expresses the number of zeros that follow the two figures.

### ⑨ Packaging

| Code     | Packaging                     | Series                           |
|----------|-------------------------------|----------------------------------|
| <b>L</b> | Embossed Taping (ø180mm Reel) | <b>NFM3D/NFM31/NFM41</b>         |
| <b>B</b> | Bulk                          | All series                       |
| <b>D</b> | Paper Taping (ø180mm Reel)    | <b>NFM15/NFM18/NFM21/NFA□□CC</b> |

### ⑥ Characteristics

| Code     | Capacitance Temperature Characteristics |
|----------|---|
| <b>B</b> | ±10%, ±12.5%, +10/-13%                  |
| <b>C</b> | ±22%                                    |
| <b>D</b> | +22/-33%                                |
| <b>F</b> | +30/-80%, +30/-84%                      |
| <b>R</b> | ±15%, +15/-18%                          |
| <b>U</b> | -750 ±120ppm/°C                         |
| <b>S</b> | +350 to -1000ppm/°C                     |

### ⑦ Rated Voltage

| Code      | Rated Voltage |
|-----------|---------------|
| <b>0E</b> | 2.5V          |
| <b>0G</b> | 4V            |
| <b>0J</b> | 6.3V          |
| <b>1A</b> | 10V           |
| <b>1C</b> | 16V           |
| <b>1E</b> | 25V           |
| <b>1H</b> | 50V           |
| <b>2A</b> | 100V          |

### ⑧ Electrode/Others (NFM Series)

| Code     | Electrode  | Series     |
|----------|------------|------------|
| <b>3</b> | Sn Plating | <b>NFM</b> |

### ⑧ Number of Circuits (NFA□□CC Series)

| Code     | Number of Circuits |
|----------|--------------------|
| <b>4</b> | 4 Circuits         |

△Note • Please read rating and △CAUTION (for storage, operating, rating, soldering, mounting and handling) in this catalog to prevent smoking and/or burning, etc.  
• This catalog has only typical specifications. Therefore, please approve our product specifications or transact the approval sheet for product specifications before ordering.

## LC Combined (1)

(Part Number)

|    |   |    |    |     |   |    |   |   |
|----|---|----|----|-----|---|----|---|---|
| NF | L | 18 | ST | 107 | X | 1C | 3 | L |
| ①  | ② | ③  | ④  | ⑤   | ⑥ | ⑦  | ⑧ | ⑨ |

### ① Product ID

| Product ID |              |
|------------|--------------|
| NF         | Chip EMIFIL® |

### ② Structure

| Code | Structure                    |
|------|------------------------------|
| W    | Wire Wound, LC Combined Type |
| L    | Multilayer, LC Combined Type |
| E    | Block, LC Combined Type      |

### ③ Dimensions (L×W)

| Code | Dimensions (L×W) | EIA  |
|------|------------------|------|
| 15   | 1.0×0.5mm        | 0402 |
| 18   | 1.6×0.8mm        | 0603 |
| 21   | 2.0×1.25mm       | 0805 |
| 31   | 3.2×1.6mm        | 1206 |
| 61   | 6.8×1.6mm        | 2706 |

### ④ Features

| Code | Features                    |
|------|-----------------------------|
| SP   | π Circuit for Signal Lines  |
| ST   | T Circuit for Signal Lines  |
| PT   | T Circuit for Large Current |

### ⑤ Cut-off Frequency (NFL/NFW Series)

Expressed by three figures. The unit is in hertz (Hz). The first and second figures are significant digits, and the third figure expresses the number of zeros that follow the two figures.

### ⑤ Capacitance (NFE Series)

Expressed by three figures. The unit is in pico-farad (pF). The first and second figures are significant digits, and the third figure expresses the number of zeros that follow the two figures.

### ⑨ Packaging

| Code | Packaging                     | Series            |
|------|-------------------------------|-------------------|
| K    | Embossed Taping (ø330mm Reel) | NFW31/NFE         |
| L    | Embossed Taping (ø180mm Reel) | NFW31/NFE         |
| B    | Bulk                          | NFL18/NFL21/NFE   |
| D    | Paper Taping (ø180mm Reel)    | NFL15/NFL18/NFL21 |

### ⑥ Characteristics (NFL/NFW Series)

| Code | Characteristics   |
|------|-------------------|
| H/X  | Cut-off Frequency |

### ⑥ Characteristics (NFE Series)

| Code | Capacitance Temperature Characteristics |
|------|---|
| B    | ±10%                                    |
| C    | ±20%, ±22%                              |
| D    | +20/-30%, +22/-33%                      |
| E    | +20/-55%, +22/-56%                      |
| F    | +30/-80%, +22/-82%                      |
| R    | ±15%                                    |
| U    | -750 ±120ppm/ °C                        |
| Z    | Other                                   |

### ⑦ Rated Voltage

| Code | Rated Voltage |
|------|---------------|
| 1A   | 10V           |
| 1C   | 16V           |
| 1E   | 25V           |
| 1H   | 50V           |
| 2A   | 100V          |

### ⑧ Electrode

| Code | Electrode                | Series |
|------|--------------------------|--------|
| 3/7  | Sn Plating               | NFL    |
| 4    | Lead Free Solder Coating | NFW    |
| 9    | Others                   | NFE    |

△Note • Please read rating and △CAUTION (for storage, operating, rating, soldering, mounting and handling) in this catalog to prevent smoking and/or burning, etc.  
• This catalog has only typical specifications. Therefore, please approve our product specifications or transact the approval sheet for product specifications before ordering.

## LC Combined (2)

(Part Number)

|    |   |    |    |     |   |    |   |   |   |
|----|---|----|----|-----|---|----|---|---|---|
| NF | A | 21 | SL | 207 | X | 1A | 4 | 5 | L |
| ①  | ② | ③  | ④  | ⑤   | ⑥ | ⑦  | ⑧ | ⑨ | ⑩ |

\*NFA□□CC Series, please refer to p.114.

\*NFA□□GD Series, please refer to p.116 (RC Combined).

### ① Product ID

| Product ID |              |
|------------|--------------|
| NF         | Chip EMIFIL® |

### ② Structure

| Code | Structure  |
|------|------------|
| A    | Array Type |

### ③ Dimensions (L×W)

| Code | Dimensions (L×W) | EIA  |
|------|------------------|------|
| 18   | 1.6×0.8mm        | 0603 |
| 21   | 2.0×1.25mm       | 0805 |

### ④ Features (1)

| Code | Features                          |
|------|-----------------------------------|
| SL   | L Circuit for Signal Lines        |
| SD   | L Circuit for Differential Signal |

### ⑤ Cut-off Frequency

Expressed by three figures. The unit is in hertz (Hz). The first and second figures are significant digits, and the third figure expresses the number of zeros that follow the two figures.

### ⑥ Features (2)

| Code | Features              |
|------|-----------------------|
| X    | Expressed by a letter |
| V    |                       |

### ⑦ Rated Voltage

| Code | Rated Voltage |
|------|---------------|
| 1A   | 10V           |

### ⑧ Number of Circuits

| Code | Number of Circuits |
|------|--------------------|
| 4    | 4 Circuits         |

### ⑨ Dimensions (T)

| Code | Dimensions (T) |
|------|----------------|
| 5    | Low Profile    |
| 8    | Standard       |

### ⑩ Packaging

| Code | Packaging                     |
|------|-------------------------------|
| B    | Bulk                          |
| L    | Embossed Taping (ø180mm Reel) |

## RC Combined

(Part Number)

|    |   |    |    |     |     |   |   |
|----|---|----|----|-----|-----|---|---|
| NF | R | 21 | GD | 470 | 470 | 2 | L |
| ①  | ② | ③  | ④  | ⑤   | ⑥   | ⑦ | ⑧ |

\*NFA□□CC Series, please refer to p.114.

\*NFA□□SL/SD Series, please refer to p.116 (LC Combined (2)).

### ① Product ID

| Product ID |              |
|------------|--------------|
| NF         | Chip EMIFIL® |

### ② Structure

| Code | Structure              |
|------|------------------------|
| R    | RC Combined Type       |
| A    | RC Combined Array Type |

### ③ Dimensions (L×W)

| Code | Dimensions (L×W) | EIA  |
|------|------------------|------|
| 21   | 2.0×1.25mm       | 0805 |
| 31   | 3.2×1.6mm        | 1206 |

### ④ Features

| Code | Features                          |
|------|-----------------------------------|
| GD   | RC Combined Type for Signal Lines |

### ⑧ Packaging

| Code | Packaging                     | Series     |
|------|-------------------------------|------------|
| L    | Embossed Taping (ø180mm Reel) | NFR        |
| B    | Bulk                          | All Series |
| D    | Paper Taping (ø180mm Reel)    | NFA□□GD    |

### ⑤ Capacitance

Expressed by three figures. The unit is in pico-farad (pF). The first and second figures are significant digits, and the third figure expresses the number of zeros that follow the two figures.

### ⑥ Resistance

Expressed by three-digit alphanumerics. The unit is in ohm (Ω). The first and second figures are significant digits, and the third figure expresses the number of zeros that follow the two figures. If there is a decimal point, it is expressed by the capital letter "R." In this case, all figures are significant digits.

### ⑦ Electrode/Others (NFR Series)

| Code | Electrode  |
|------|------------|
| 2    | Sn Plating |

### ⑦ Number of Circuits (NFA□□GD Series)

| Code | Number of Circuits |
|------|--------------------|
| 4    | 4 Circuits         |

△Note • Please read rating and △CAUTION (for storage, operating, rating, soldering, mounting and handling) in this catalog to prevent smoking and/or burning, etc.  
 • This catalog has only typical specifications. Therefore, please approve our product specifications or transact the approval sheet for product specifications before ordering.

| Type                               | Size Code<br>in nch (in mm) | Thickness<br>(mm) | Part Number    | Rated<br>Voltage | Capacitance     | Nominal<br>Cut-off<br>Frequency | Rated<br>Current | New | Kit | ≥1A | ≥3A | ≥10A | DTV              | F <sub>low</sub>                 | R <sub>ef</sub> F <sub>low</sub> |
|------------------------------------|-----------------------------|-------------------|----------------|------------------|-----------------|---------------------------------|------------------|-----|-----|-----|-----|------|------------------|----------------------------------|----------------------------------|
| Capacitor Type<br>for Signal Lines | 0402<br>(1005)              | 0.4               | NFM15CC222D1A3 | 10Vdc            | 2200pF+20%-20%  | -                               | 1A               | New | Kit | ≥1A |     |      |                  |                                  | R <sub>ef</sub> F <sub>low</sub> |
|                                    |                             |                   | NFM15CC222D1C3 | 16Vdc            | 2200pF+20%-20%  | -                               | 1A               | New | Kit | ≥1A |     |      |                  |                                  | R <sub>ef</sub> F <sub>low</sub> |
|                                    |                             |                   | NFM15CC223C1A3 | 10Vdc            | 22000pF+20%-20% | -                               | 1A               | New | Kit | ≥1A |     |      |                  |                                  | R <sub>ef</sub> F <sub>low</sub> |
|                                    |                             |                   | NFM15CC223C1C3 | 16Vdc            | 22000pF+20%-20% | -                               | 1A               | New | Kit | ≥1A |     |      |                  |                                  | R <sub>ef</sub> F <sub>low</sub> |
|                                    | 0603<br>(1608)              | 0.6               | NFM18CC220U1C3 | 16Vdc            | 22pF+20%-20%    | -                               | 400mA            |     | Kit |     |     |      |                  |                                  | R <sub>ef</sub> F <sub>low</sub> |
|                                    |                             |                   | NFM18CC470U1C3 | 16Vdc            | 47pF+20%-20%    | -                               | 400mA            |     | Kit |     |     |      |                  |                                  | R <sub>ef</sub> F <sub>low</sub> |
|                                    |                             |                   | NFM18CC101R1C3 | 16Vdc            | 100pF+20%-20%   | -                               | 500mA            |     | Kit |     |     |      |                  |                                  | R <sub>ef</sub> F <sub>low</sub> |
|                                    |                             |                   | NFM18CC221R1C3 | 16Vdc            | 220pF+20%-20%   | -                               | 500mA            |     | Kit |     |     |      |                  |                                  | R <sub>ef</sub> F <sub>low</sub> |
|                                    |                             |                   | NFM18CC471R1C3 | 16Vdc            | 470pF+20%-20%   | -                               | 500mA            |     | Kit |     |     |      |                  |                                  | R <sub>ef</sub> F <sub>low</sub> |
|                                    |                             |                   | NFM18CC102R1C3 | 16Vdc            | 1000pF+20%-20%  | -                               | 600mA            |     | Kit |     |     |      |                  |                                  | R <sub>ef</sub> F <sub>low</sub> |
|                                    |                             |                   | NFM18CC222R1C3 | 16Vdc            | 2200pF+20%-20%  | -                               | 700mA            |     | Kit |     |     |      |                  |                                  | R <sub>ef</sub> F <sub>low</sub> |
|                                    |                             |                   | NFM18CC223R1C3 | 16Vdc            | 22000pF+20%-20% | -                               | 1000mA           |     | Kit | ≥1A |     |      |                  |                                  |                                  |
|                                    | 0805<br>(2012)              | 0.85              | NFM21CC220U1H3 | 50Vdc            | 22pF+20%-20%    | -                               | 700mA            |     | Kit |     |     |      |                  |                                  | R <sub>ef</sub> F <sub>low</sub> |
|                                    |                             |                   | NFM21CC470U1H3 | 50Vdc            | 47pF+20%-20%    | -                               | 700mA            |     | Kit |     |     |      |                  |                                  | R <sub>ef</sub> F <sub>low</sub> |
|                                    |                             |                   | NFM21CC101U1H3 | 50Vdc            | 100pF+20%-20%   | -                               | 700mA            |     | Kit |     |     |      |                  |                                  | R <sub>ef</sub> F <sub>low</sub> |
|                                    |                             |                   | NFM21CC221R1H3 | 50Vdc            | 220pF+20%-20%   | -                               | 700mA            |     | Kit |     |     |      |                  |                                  | R <sub>ef</sub> F <sub>low</sub> |
|                                    |                             |                   | NFM21CC471R1H3 | 50Vdc            | 470pF+20%-20%   | -                               | 1000mA           |     | Kit | ≥1A |     |      |                  |                                  | R <sub>ef</sub> F <sub>low</sub> |
|                                    |                             |                   | NFM21CC102R1H3 | 50Vdc            | 1000pF+20%-20%  | -                               | 1000mA           |     | Kit | ≥1A |     |      |                  |                                  | R <sub>ef</sub> F <sub>low</sub> |
|                                    |                             |                   | NFM21CC222R1H3 | 50Vdc            | 2200pF+20%-20%  | -                               | 1000mA           |     | Kit | ≥1A |     |      |                  |                                  | R <sub>ef</sub> F <sub>low</sub> |
|                                    |                             |                   | NFM21CC223R1H3 | 50Vdc            | 22000pF+20%-20% | -                               | 2000mA           |     | Kit | ≥1A |     |      |                  |                                  | R <sub>ef</sub> F <sub>low</sub> |
|                                    | 1205<br>(3212)              | 0.7               | NFM3DCC220U1H3 | 50Vdc            | 22pF+50%-20%    | -                               | 300mA            |     |     |     |     |      |                  | F <sub>low</sub>                 | R <sub>ef</sub> F <sub>low</sub> |
|                                    |                             |                   | NFM3DCC470U1H3 | 50Vdc            | 47pF+50%-20%    | -                               | 300mA            |     |     |     |     |      |                  | F <sub>low</sub>                 | R <sub>ef</sub> F <sub>low</sub> |
|                                    |                             |                   | NFM3DCC101U1H3 | 50Vdc            | 100pF+50%-20%   | -                               | 300mA            |     |     |     |     |      |                  | F <sub>low</sub>                 | R <sub>ef</sub> F <sub>low</sub> |
|                                    |                             |                   | NFM3DCC221R1H3 | 50Vdc            | 220pF+50%-20%   | -                               | 300mA            |     |     |     |     |      |                  | F <sub>low</sub>                 | R <sub>ef</sub> F <sub>low</sub> |
|                                    |                             |                   | NFM3DCC471R1H3 | 50Vdc            | 470pF+50%-20%   | -                               | 300mA            |     |     |     |     |      |                  | F <sub>low</sub>                 | R <sub>ef</sub> F <sub>low</sub> |
|                                    |                             |                   | NFM3DCC102R1H3 | 50Vdc            | 1000pF+50%-20%  | -                               | 300mA            |     |     |     |     |      |                  | F <sub>low</sub>                 | R <sub>ef</sub> F <sub>low</sub> |
|                                    |                             |                   | NFM3DCC222R1H3 | 50Vdc            | 2200pF+50%-20%  | -                               | 300mA            |     |     |     |     |      |                  | F <sub>low</sub>                 | R <sub>ef</sub> F <sub>low</sub> |
|                                    |                             |                   | NFM3DCC223R1H3 | 50Vdc            | 22000pF+50%-20% | -                               | 300mA            |     |     |     |     |      |                  | F <sub>low</sub>                 | R <sub>ef</sub> F <sub>low</sub> |
|                                    | 1806<br>(4516)              | 1.0               | NFM41CC220U2A3 | 100Vdc           | 22pF+50%-20%    | -                               | 300mA            |     |     |     |     |      |                  | F <sub>low</sub>                 | R <sub>ef</sub> F <sub>low</sub> |
|                                    |                             |                   | NFM41CC470U2A3 | 100Vdc           | 47pF+50%-20%    | -                               | 300mA            |     |     |     |     |      |                  | F <sub>low</sub>                 | R <sub>ef</sub> F <sub>low</sub> |
|                                    |                             |                   | NFM41CC101U2A3 | 100Vdc           | 100pF+50%-20%   | -                               | 300mA            |     |     |     |     |      |                  | F <sub>low</sub>                 | R <sub>ef</sub> F <sub>low</sub> |
|                                    |                             |                   | NFM41CC221U2A3 | 100Vdc           | 220pF+50%-20%   | -                               | 300mA            |     |     |     |     |      |                  | F <sub>low</sub>                 | R <sub>ef</sub> F <sub>low</sub> |
| NFM41CC471R2A3                     |                             |                   | 100Vdc         | 470pF+50%-20%    | -               | 300mA                           |                  |     |     |     |     |      | F <sub>low</sub> | R <sub>ef</sub> F <sub>low</sub> |                                  |
| NFM41CC102R2A3                     |                             |                   | 100Vdc         | 1000pF+50%-20%   | -               | 300mA                           |                  |     |     |     |     |      | F <sub>low</sub> | R <sub>ef</sub> F <sub>low</sub> |                                  |
| NFM41CC222R2A3                     |                             |                   | 100Vdc         | 2200pF+50%-20%   | -               | 300mA                           |                  |     |     |     |     |      | F <sub>low</sub> | R <sub>ef</sub> F <sub>low</sub> |                                  |
| NFM41CC223R2A3                     |                             |                   | 100Vdc         | 22000pF+50%-20%  | -               | 300mA                           |                  |     |     |     |     |      | F <sub>low</sub> | R <sub>ef</sub> F <sub>low</sub> |                                  |
| 1206<br>(3216)                     | 0.8                         | NFA31CC220S1E4    | 25Vdc          | 22pF+20%-20%     | -               | 200mA                           |                  | Kit |     |     |     |      |                  | R <sub>ef</sub> F <sub>low</sub> |                                  |
|                                    |                             | NFA31CC470S1E4    | 25Vdc          | 47pF+20%-20%     | -               | 200mA                           |                  | Kit |     |     |     |      |                  | R <sub>ef</sub> F <sub>low</sub> |                                  |
|                                    |                             | NFA31CC101S1E4    | 25Vdc          | 100pF+20%-20%    | -               | 200mA                           |                  | Kit |     |     |     |      |                  | R <sub>ef</sub> F <sub>low</sub> |                                  |
|                                    |                             | NFA31CC221S1E4    | 25Vdc          | 220pF+20%-20%    | -               | 200mA                           |                  | Kit |     |     |     |      |                  | R <sub>ef</sub> F <sub>low</sub> |                                  |
|                                    |                             | NFA31CC471R1E4    | 25Vdc          | 470pF+20%-20%    | -               | 200mA                           |                  | Kit |     |     |     |      |                  | R <sub>ef</sub> F <sub>low</sub> |                                  |
|                                    |                             | NFA31CC102R1E4    | 25Vdc          | 1000pF+20%-20%   | -               | 200mA                           |                  | Kit |     |     |     |      |                  | R <sub>ef</sub> F <sub>low</sub> |                                  |
|                                    |                             | NFA31CC222R1E4    | 25Vdc          | 2200pF+20%-20%   | -               | 200mA                           |                  | Kit |     |     |     |      |                  | R <sub>ef</sub> F <sub>low</sub> |                                  |
|                                    |                             | NFA31CC223R1C4    | 16Vdc          | 22000pF+20%-20%  | -               | 200mA                           |                  | Kit |     |     |     |      |                  | R <sub>ef</sub> F <sub>low</sub> |                                  |

Continued on the following page.

△Note • Please read rating and △CAUTION (for storage, operating, rating, soldering, mounting and handling) in this catalog to prevent smoking and/or burning, etc.  
• This catalog has only typical specifications. Therefore, please approve our product specifications or transact the approval sheet for product specifications before ordering.

| Type                              | Size Code<br>in nch (in mm)                             | Thickness<br>(mm)                    | Part Number    | Rated<br>Voltage | Capacitance    | Nominal<br>Cut-off<br>Frequency | Rated<br>Current | New | Kit | ≥1A | ≥3A  | ≥10A | Dtv | F <sub>low</sub>    | R <sub>eF</sub> low |                     |                     |
|-----------------------------------|---|--------------------------------------|----------------|------------------|----------------|---------------------------------|------------------|-----|-----|-----|------|------|-----|---------------------|---------------------|---------------------|---------------------|
|                                   |   |                                      |                |                  |                |                                 |                  | Kit | ≥1A | ≥3A | ≥10A |      |     |                     |                     |                     |                     |
| Capacitor Type<br>for Power Lines | 0402<br>(1005)  | p123                                 | 0.4            | NFM15PC473C1A3   | 10Vdc          | 0.047µF+20%-20%                 | -                | 1A  | New | Kit | ≥1A  |      |     |                     | R <sub>eF</sub> low |                     |                     |
|                                   |   |                                      | 0.4            | NFM15PC473C1C3   | 16Vdc          | 0.047µF+20%-20%                 | -                | 1A  | New | Kit | ≥1A  |      |     |                     | R <sub>eF</sub> low |                     |                     |
|                                   |   | 0.4                                  | NFM15PC104D0J3 | 6.3Vdc           | 0.1µF+20%-20%  | -                               | 2A               | New | Kit | ≥1A |      |      |     | R <sub>eF</sub> low |                     |                     |                     |
|                                   |   | 0.4                                  | NFM15PC104R1A3 | 10Vdc            | 0.1µF+20%-20%  | -                               | 2A               | New | Kit | ≥1A |      |      |     | R <sub>eF</sub> low |                     |                     |                     |
|                                   |   | 0.4                                  | NFM15PC224D0J3 | 6.3Vdc           | 0.22µF+20%-20% | -                               | 2A               | New | Kit | ≥1A |      |      |     | R <sub>eF</sub> low |                     |                     |                     |
|                                   |   | 0.4                                  | NFM15PC224R1A3 | 10Vdc            | 0.22µF+20%-20% | -                               | 2A               | New | Kit | ≥1A |      |      |     | R <sub>eF</sub> low |                     |                     |                     |
|                                   |   | 0.3                                  | NFM15PC474D0G3 | 4Vdc             | 0.47µF+20%-20% | -                               | 2A               | New | Kit | ≥1A |      |      |     | R <sub>eF</sub> low |                     |                     |                     |
|                                   |   | 0.3                                  | NFM15PC474R0J3 | 6.3Vdc           | 0.47µF+20%-20% | -                               | 2A               | New | Kit | ≥1A |      |      |     | R <sub>eF</sub> low |                     |                     |                     |
|                                   |   | 0.3                                  | NFM15PC105R0G3 | 4Vdc             | 1µF+20%-20%    | -                               | 2A               | New | Kit | ≥1A |      |      |     | R <sub>eF</sub> low |                     |                     |                     |
|                                   |   | 0.4                                  | NFM15PC435R0E3 | 2.5Vdc           | 4.3µF+20%-20%  | -                               | 2A               | New | Kit | ≥1A |      |      |     | R <sub>eF</sub> low |                     |                     |                     |
|                                   | 0603<br>(1608)  | p125                                 | 0.6            | NFM18PS474R0J3   | 6.3Vdc         | 0.47µF+20%-20%                  | -                | 2A  |     | Kit | ≥1A  |      |     |                     | R <sub>eF</sub> low |                     |                     |
|                                   |   |                                      | 0.6            | NFM18PS105D0J3   | 6.3Vdc         | 1.0µF+20%-20%                   | -                | 2A  | New | Kit | ≥1A  |      |     |                     | R <sub>eF</sub> low |                     |                     |
|                                   |   |                                      | 0.6            | NFM18PS105R0J3   | 6.3Vdc         | 1.0µF+20%-20%                   | -                | 2A  |     | Kit | ≥1A  |      |     |                     | R <sub>eF</sub> low |                     |                     |
|                                   |   | p126                                 | 0.6            | NFM18PC104R1C3   | 16Vdc          | 0.1µF+20%-20%                   | -                | 2A  |     | Kit | ≥1A  |      |     |                     | R <sub>eF</sub> low |                     |                     |
|                                   |   |                                      | 0.6            | NFM18PC224R0J3   | 6.3Vdc         | 0.22µF+20%-20%                  | -                | 2A  |     | Kit | ≥1A  |      |     |                     | R <sub>eF</sub> low |                     |                     |
|                                   |   |                                      | 0.6            | NFM18PC474R0J3   | 6.3Vdc         | 0.47µF+20%-20%                  | -                | 2A  |     | Kit | ≥1A  |      |     |                     | R <sub>eF</sub> low |                     |                     |
|                                   |   |                                      | 0.8            | NFM18PC105R0J3   | 6.3Vdc         | 1.0µF+20%-20%                   | -                | 4A  |     | Kit | ≥1A  |      |     |                     | R <sub>eF</sub> low |                     |                     |
|                                   |   |                                      | 0.6            | NFM18PC225B0J3   | 6.3Vdc         | 2.2µF+20%-20%                   | -                | 2A  |     | Kit | ≥1A  |      |     |                     | R <sub>eF</sub> low |                     |                     |
|                                   |   |                                      | 0.8            | NFM18PC225B1A3   | 10Vdc          | 2.2µF+20%-20%                   | -                | 4A  |     | Kit | ≥3A  |      |     |                     | R <sub>eF</sub> low |                     |                     |
|                                   |   |                                      | 0.85           | NFM21PS106B0J3   | 6.3Vdc         | 10µF+20%-20%                    | -                | 4A  |     | Kit | ≥3A  |      |     |                     | R <sub>eF</sub> low |                     |                     |
|                                   | 0805<br>(2012)  | p128                                 | 0.85           | NFM21PC104R1E3   | 25Vdc          | 0.1µF+20%-20%                   | -                | 2A  |     | Kit | ≥1A  |      |     |                     | R <sub>eF</sub> low |                     |                     |
|                                   |   | p129                                 | 0.85           | NFM21PC224R1C3   | 16Vdc          | 0.22µF+20%-20%                  | -                | 2A  |     | Kit | ≥1A  |      |     |                     | R <sub>eF</sub> low |                     |                     |
|                                   |   |                                      | 0.85           | NFM21PC474R1C3   | 16Vdc          | 0.47µF+20%-20%                  | -                | 2A  |     | Kit | ≥1A  |      |     |                     | R <sub>eF</sub> low |                     |                     |
|                                   |   |                                      | 0.85           | NFM21PC105B1A3   | 10Vdc          | 1.0µF+20%-20%                   | -                | 4A  |     | Kit | ≥3A  |      |     |                     | R <sub>eF</sub> low |                     |                     |
|                                   |   |                                      | 0.85           | NFM21PC105B1C3   | 16Vdc          | 1.0µF+20%-20%                   | -                | 4A  |     | Kit | ≥3A  |      |     |                     | R <sub>eF</sub> low |                     |                     |
|                                   |   |                                      | 0.85           | NFM21PC225B0J3   | 6.3Vdc         | 2.2µF+20%-20%                   | -                | 4A  |     | Kit | ≥3A  |      |     |                     | R <sub>eF</sub> low |                     |                     |
|                                   |   |                                      | 0.85           | NFM21PC475B1A3   | 10Vdc          | 4.7µF+20%-20%                   | -                | 6A  |     | Kit | ≥3A  |      |     |                     | R <sub>eF</sub> low |                     |                     |
|                                   | 1206<br>(3216)  | <sup>1205</sup><br><sup>(3212)</sup> | p130           | 0.7              | NFM3DPC223R1H3 | 50Vdc                           | 0.022µF+20%-20%  | -   | 2A  |     |      | ≥1A  |     |                     | F <sub>low</sub>    | R <sub>eF</sub> low |                     |
|                                   |   | p131                                 | 1.3            | NFM31PC276B0J3   | 6.3Vdc         | 27µF+20%-20%                    | -                | 6A  |     | Kit | ≥3A  |      |     |                     | F <sub>low</sub>    | R <sub>eF</sub> low |                     |
|                                   |   |                                      | p132           | 1.3              | NFM31KC103R1H3 | 50Vdc                           | 10000pF+20%-20%  | -   | 10A |     | Kit  | ≥10A |     |                     |                     | F <sub>low</sub>    | R <sub>eF</sub> low |
|                                   |   | 1.3                                  |                | NFM31KC103R2A3   | 100Vdc         | 10000pF+20%-20%                 | -                | 10A |     | Kit | ≥10A |      |     |                     | F <sub>low</sub>    | R <sub>eF</sub> low |                     |
|                                   |   | 1.3                                  |                | NFM31KC153R1H3   | 50Vdc          | 15000pF+20%-20%                 | -                | 10A |     | Kit | ≥10A |      |     |                     | F <sub>low</sub>    | R <sub>eF</sub> low |                     |
|                                   |   | 1.3                                  |                | NFM31KC153R2A3   | 100Vdc         | 15000pF+20%-20%                 | -                | 10A |     | Kit | ≥10A |      |     |                     | F <sub>low</sub>    | R <sub>eF</sub> low |                     |
|                                   |   | 1.3                                  |                | NFM31KC223R1H3   | 50Vdc          | 22000pF+20%-20%                 | -                | 10A |     | Kit | ≥10A |      |     |                     | F <sub>low</sub>    | R <sub>eF</sub> low |                     |
|                                   |   | 1.3                                  |                | NFM31KC223R2A3   | 100Vdc         | 22000pF+20%-20%                 | -                | 10A |     | Kit | ≥10A |      |     |                     | F <sub>low</sub>    | R <sub>eF</sub> low |                     |
|                                   |   | 1.3                                  |                | NFM31KC104R1H3   | 50Vdc          | 100000pF+20%-20%                | -                | 6A  |     | Kit | ≥3A  |      |     |                     | F <sub>low</sub>    | R <sub>eF</sub> low |                     |
|                                   |   | 1.3                                  |                | NFM31KC104R2A3   | 100Vdc         | 100000pF+20%-20%                | -                | 6A  |     | Kit | ≥3A  |      |     |                     | F <sub>low</sub>    | R <sub>eF</sub> low |                     |
|                                   | 1806<br>(4516)  | p133                                 | 1.0            | NFM41PC204F1H3   | 50Vdc          | 0.2µF+80%-20%                   | -                | 2A  |     | Kit | ≥1A  |      |     |                     | F <sub>low</sub>    | R <sub>eF</sub> low |                     |
|                                   |   |                                      | 1.0            | NFM41PC155B1E3   | 25Vdc          | 1.5µF+20%-20%                   | -                | 6A  |     | Kit | ≥3A  |      |     |                     | F <sub>low</sub>    | R <sub>eF</sub> low |                     |
|                                   |   |                                      | 1.0            | NFM41PC155B1H3   | 50Vdc          | 1.5µF+20%-20%                   | -                | 6A  | New |     | ≥3A  |      |     |                     | F <sub>low</sub>    | R <sub>eF</sub> low |                     |
|                                   | LC Combined Type<br>for Power Lines<br>and Signal Lines | 1206<br>(3216)                       | p121           | 1.6              | NFE31PT220R1E9 | 25Vdc                           | 22pF+30%-30%     | -   | 6A  |     |      | ≥3A  |     |                     |                     | R <sub>eF</sub> low |                     |
|                                   |   |                                      |                | 1.6              | NFE31PT470C1E9 | 25Vdc                           | 47pF+50%-20%     | -   | 6A  |     |      | ≥3A  |     |                     |                     | R <sub>eF</sub> low |                     |
|                                   |   |                                      |                | 1.6              | NFE31PT101C1E9 | 25Vdc                           | 100pF+80%-20%    | -   | 6A  |     |      | ≥3A  |     |                     |                     | R <sub>eF</sub> low |                     |
|                                   |   |                                      |                | 1.6              | NFE31PT221D1E9 | 25Vdc                           | 220pF+50%-20%    | -   | 6A  |     |      | ≥3A  |     |                     |                     | R <sub>eF</sub> low |                     |
|                                   |   |                                      |                | 1.6              | NFE31PT471F1E9 | 25Vdc                           | 470pF+50%-20%    | -   | 6A  |     |      | ≥3A  |     |                     |                     | R <sub>eF</sub> low |                     |
|                                   |   |                                      |                | 1.6              | NFE31PT152Z1E9 | 25Vdc                           | 1500pF+50%-20%   | -   | 6A  |     | Kit  | ≥3A  |     |                     |                     | R <sub>eF</sub> low |                     |
|                                   |   | 2706<br>(6816)                       | p122           | 1.6              | NFE61PT330B1H9 | 50Vdc                           | 33pF+30%-30%     | -   | 2A  |     |      | ≥1A  |     |                     |                     | F <sub>low</sub>    | R <sub>eF</sub> low |
|                                   |   |                                      |                | 1.6              | NFE61PT680B1H9 | 50Vdc                           | 68pF+30%-30%     | -   | 2A  |     |      | ≥1A  |     |                     |                     | F <sub>low</sub>    | R <sub>eF</sub> low |
|                                   |   |                                      |                | 1.6              | NFE61PT101Z1H9 | 50Vdc                           | 100pF+30%-30%    | -   | 2A  |     |      | ≥1A  |     |                     |                     | F <sub>low</sub>    | R <sub>eF</sub> low |
|                                   |   |                                      |                | 1.6              | NFE61PT181B1H9 | 50Vdc                           | 180pF+30%-30%    | -   | 2A  |     |      | ≥1A  |     |                     |                     | F <sub>low</sub>    | R <sub>eF</sub> low |
| 1.6                               |   |                                      |                | NFE61PT361B1H9   | 50Vdc          | 360pF+20%-20%                   | -                | 2A  |     |     | ≥1A  |      |     |                     | F <sub>low</sub>    | R <sub>eF</sub> low |                     |
| 1.6                               |   |                                      |                | NFE61PT681B1H9   | 50Vdc          | 680pF+30%-30%                   | -                | 2A  |     |     | ≥1A  |      |     |                     | F <sub>low</sub>    | R <sub>eF</sub> low |                     |
| 1.6                               |   |                                      |                | NFE61PT102E1H9   | 50Vdc          | 1000pF+80%-20%                  | -                | 2A  |     | Kit | ≥1A  |      |     |                     | F <sub>low</sub>    | R <sub>eF</sub> low |                     |
| 1.6                               |   |                                      |                | NFE61PT472C1H9   | 50Vdc          | 4700pF+80%-20%                  | -                | 2A  |     | Kit | ≥1A  |      |     |                     | F <sub>low</sub>    | R <sub>eF</sub> low |                     |

Continued on the following page. ↗

△Note • Please read rating and △CAUTION (for storage, operating, rating, soldering, mounting and handling) in this catalog to prevent smoking and/or burning, etc.  
• This catalog has only typical specifications. Therefore, please approve our product specifications or transact the approval sheet for product specifications before ordering.



| Type   | Size Code<br>in nch (in mm)                   | Thickness<br>(mm) | Part Number     | Rated<br>Voltage | Capacitance  | Nominal<br>Cut-off<br>Frequency | Rated<br>Current | Performance |         |                                      |         |         |
|--|---|-------------------|-----------------|------------------|--------------|---------------------------------|------------------|-------------|---------|--------------------------------------|---------|---------|
|  |   |                   |                 |                  |              |                                 |                  | New         | Kit     | $\geq 1A$<br>$\geq 3A$<br>$\geq 10A$ | DTV     | Flow    |
| LC Combined<br>Multilayer Type<br>for Signal Lines | 0402<br>(1005)                                | p140<br>0.3       | NFL15ST157X0J3  | 6.3Vdc           | 22pF (Typ.)  | 150MHz                          | 50mA             | Kit         |         | DTV                                  | RefFlow |         |
|  |   |                   | NFL15ST207X0J3  | 6.3Vdc           | 17pF (Typ.)  | 200MHz                          | 50mA             | Kit         |         | DTV                                  | RefFlow |         |
|  |   |                   | NFL15ST307X0J3  | 6.3Vdc           | 12pF (Typ.)  | 300MHz                          | 50mA             | Kit         |         |                                      | RefFlow |         |
|  |   |                   | NFL15ST507X0J3  | 6.3Vdc           | 7pF (Typ.)   | 500MHz                          | 50mA             | Kit         |         |                                      | RefFlow |         |
|  | 0603<br>(1608)                                | p141<br>0.6       | NFL18ST506H1A3  | 10Vdc            | 110pF (Typ.) | 50MHz                           | 75mA             | Kit         |         | DTV                                  | RefFlow |         |
|  |   |                   | NFL18ST706H1A3  | 10Vdc            | 70pF (Typ.)  | 70MHz                           | 75mA             | Kit         |         | DTV                                  | RefFlow |         |
|  |   |                   | NFL18ST107H1A3  | 10Vdc            | 50pF (Typ.)  | 100MHz                          | 75mA             | Kit         |         | DTV                                  | RefFlow |         |
|  |   |                   | NFL18ST207H1A3  | 10Vdc            | 22pF (Typ.)  | 200MHz                          | 100mA            | Kit         |         | DTV                                  | RefFlow |         |
|  |   |                   | NFL18ST307H1A3  | 10Vdc            | 16pF (Typ.)  | 300MHz                          | 100mA            | Kit         |         |                                      | RefFlow |         |
|  |   |                   | NFL18ST507H1A3  | 10Vdc            | 10pF (Typ.)  | 500MHz                          | 100mA            | Kit         |         |                                      | RefFlow |         |
|  |   | p142<br>0.8       | NFL18ST207X1C3  | 16Vdc            | 25pF+20%-20% | 200MHz                          | 150mA            | Kit         |         |                                      | RefFlow |         |
|  |   |                   | NFL18ST307X1C3  | 16Vdc            | 18pF+20%-20% | 300MHz                          | 200mA            | Kit         |         |                                      | RefFlow |         |
|  |   |                   | NFL18ST507X1C3  | 16Vdc            | 10pF+20%-20% | 500MHz                          | 200mA            | Kit         |         |                                      | RefFlow |         |
|  |   |                   | p143<br>0.6     | NFL18SP157X1A3   | 10Vdc        | 34pF+20%-20%                    | 150MHz           | 100mA       | Kit     |                                      |         | RefFlow |
|  | NFL18SP207X1A3                                | 10Vdc             |                 | 24pF+20%-20%     | 200MHz       | 100mA                           | Kit              |             |         | RefFlow                              |         |         |
|  | NFL18SP307X1A3                                | 10Vdc             |                 | 19pF+20%-20%     | 300MHz       | 100mA                           | Kit              |             |         | RefFlow                              |         |         |
|  | NFL18SP507X1A3                                | 10Vdc             |                 | 11pF+20%-20%     | 500MHz       | 100mA                           | Kit              |             |         | RefFlow                              |         |         |
|  | 0805<br>(2012)                                | p144<br>0.85      |                 | NFL21SP106X1C3   | 16Vdc        | 670pF+20%-20%                   | 10MHz            | 100mA       | Kit     |                                      |         | RefFlow |
|  |   |                   |                 | NFL21SP206X1C7   | 16Vdc        | 240pF+20%-20%                   | 20MHz            | 100mA       | Kit     |                                      |         | RefFlow |
|  |   |                   | NFL21SP506X1C3  | 16Vdc            | 84pF+20%-20% | 50MHz                           | 150mA            | Kit         |         |                                      | RefFlow |         |
|  |   |                   | NFL21SP706X1C3  | 16Vdc            | 76pF+20%-20% | 70MHz                           | 150mA            | Kit         |         |                                      | RefFlow |         |
|  |   |                   | NFL21SP107X1C3  | 16Vdc            | 44pF+20%-20% | 100MHz                          | 200mA            | Kit         |         |                                      | RefFlow |         |
|  |   |                   | NFL21SP157X1C3  | 16Vdc            | 28pF+20%-20% | 150MHz                          | 200mA            | Kit         |         |                                      | RefFlow |         |
|  |   |                   | NFL21SP207X1C3  | 16Vdc            | 22pF+20%-20% | 200MHz                          | 250mA            | Kit         |         |                                      | RefFlow |         |
|  |   |                   | NFL21SP307X1C3  | 16Vdc            | 19pF+10%-10% | 300MHz                          | 300mA            | Kit         |         |                                      | RefFlow |         |
|  | NFL21SP407X1C3                                | 16Vdc             | 16pF+10%-10%    | 400MHz           | 300mA        | Kit                             |                  |             | RefFlow |                                      |         |         |
|  | NFL21SP507X1C3                                | 16Vdc             | 12pF+10%-10%    | 500MHz           | 300mA        | Kit                             |                  |             | RefFlow |                                      |         |         |
|  | LC Combined<br>Array Type<br>for Signal Lines | 0603<br>(1608)    | p145<br>0.6     | NFA18SL137V1A45  | 10Vdc        | -                               | 130MHz           | 50mA        | Kit     |                                      | DTV     | RefFlow |
|  |   |                   |                 | NFA18SL187V1A45  | 10Vdc        | -                               | 180MHz           | 50mA        | Kit     |                                      | DTV     | RefFlow |
|  |   |                   |                 | NFA18SL207V1A45  | 10Vdc        | -                               | 200MHz           | 50mA        | Kit     |                                      | DTV     | RefFlow |
|  |   |                   |                 | NFA18SL227V1A45  | 10Vdc        | -                               | 220MHz           | 25mA        | Kit     |                                      | DTV     | RefFlow |
|  |   |                   |                 | NFA18SL307V1A45  | 10Vdc        | -                               | 300MHz           | 100mA       | Kit     |                                      |         | RefFlow |
| NFA18SL357V1A45                                    |   |                   |                 | 10Vdc            | -            | 350MHz                          | 35mA             | Kit         |         |                                      | RefFlow |         |
| p146<br>0.6  |   |                   | NFA18SL407V1A45 | 10Vdc            | -            | 400MHz                          | 100mA            | Kit         |         |                                      | RefFlow |         |
|  |   |                   | NFA18SL487V1A45 | 10Vdc            | -            | 480MHz                          | 100mA            | Kit         |         |                                      | RefFlow |         |
| p147<br>0.6  |   |                   | NFA18SD187X1A45 | 10Vdc            | -            | 180MHz                          | 25mA             | Kit         |         | DTV                                  | RefFlow |         |
|  |   |                   | NFA18SD207X1A45 | 10Vdc            | -            | 200MHz                          | 25mA             | Kit         |         | DTV                                  | RefFlow |         |
| 0805<br>(2012)                                     |   | p148<br>0.5       | NFA21SL287V1A45 | 10Vdc            | -            | 280MHz                          | 100mA            | Kit         |         |                                      | RefFlow |         |
|  |   |                   | NFA21SL317V1A45 | 10Vdc            | -            | 310MHz                          | 100mA            | Kit         |         |                                      | RefFlow |         |
|  |   |                   | NFA21SL337V1A45 | 10Vdc            | -            | 330MHz                          | 100mA            | Kit         |         |                                      | RefFlow |         |
|  |   |                   | NFA21SL287V1A48 | 10Vdc            | -            | 280MHz                          | 100mA            | Kit         |         |                                      | RefFlow |         |
|  |   |                   | NFA21SL317V1A48 | 10Vdc            | -            | 310MHz                          | 100mA            | Kit         |         |                                      | RefFlow |         |
|  |   |                   | NFA21SL337V1A48 | 10Vdc            | -            | 330MHz                          | 100mA            | Kit         |         |                                      | RefFlow |         |
|  |   |                   | p149<br>0.5     | NFA21SL207X1A45  | 10Vdc        | -                               | 200MHz           | 100mA       | Kit     |                                      |         | RefFlow |
|  |   |                   |                 | NFA21SL307X1A45  | 10Vdc        | -                               | 300MHz           | 100mA       | Kit     |                                      |         | RefFlow |
|  |   |                   |                 | NFA21SL506X1A48  | 10Vdc        | -                               | 50MHz            | 20mA        | Kit     |                                      |         | RefFlow |
|  |   |                   |                 | NFA21SL806X1A48  | 10Vdc        | -                               | 80MHz            | 20mA        | Kit     |                                      |         | RefFlow |
|  |   |                   |                 | NFA21SL207X1A48  | 10Vdc        | -                               | 200MHz           | 100mA       | Kit     |                                      |         | RefFlow |
|  |   |                   |                 | NFA21SL307X1A48  | 10Vdc        | -                               | 300MHz           | 100mA       | Kit     |                                      |         | RefFlow |
| LC Combined<br>Wire Wound Type<br>for Signal Lines | 1206<br>(3216)                                | p150<br>1.8       | NFW31SP106X1E4  | 25Vdc            | -            | 10MHz                           | 200mA            | Kit         |         | Flow                                 | RefFlow |         |
|  |   |                   | NFW31SP206X1E4  | 25Vdc            | -            | 20MHz                           | 200mA            | Kit         |         | Flow                                 | RefFlow |         |
|  |   |                   | NFW31SP506X1E4  | 25Vdc            | -            | 50MHz                           | 200mA            | Kit         |         | Flow                                 | RefFlow |         |
|  |   |                   | NFW31SP107X1E4  | 25Vdc            | -            | 100MHz                          | 200mA            | Kit         |         | Flow                                 | RefFlow |         |
|  |   |                   | NFW31SP157X1E4  | 25Vdc            | -            | 150MHz                          | 200mA            | Kit         |         | Flow                                 | RefFlow |         |
|  |   |                   | NFW31SP207X1E4  | 25Vdc            | -            | 200MHz                          | 200mA            | Kit         |         | Flow                                 | RefFlow |         |
|  |   |                   | NFW31SP307X1E4  | 25Vdc            | -            | 300MHz                          | 200mA            | Kit         |         | Flow                                 | RefFlow |         |
|  |   |                   | NFW31SP407X1E4  | 25Vdc            | -            | 400MHz                          | 200mA            | Kit         |         | Flow                                 | RefFlow |         |
| NFW31SP507X1E4                                     | 25Vdc   | -                 | 500MHz          | 200mA            | Kit          |                                 | Flow             | RefFlow     |         |                                      |         |         |

Continued on the following page.

⚠Note • Please read rating and ⚠CAUTION (for storage, operating, rating, soldering, mounting and handling) in this catalog to prevent smoking and/or burning, etc.  
• This catalog has only typical specifications. Therefore, please approve our product specifications or transact the approval sheet for product specifications before ordering.

| Type  | Size Code<br>in nch (in mm) | Thickness<br>(mm) | Part Number           | Rated<br>Voltage      | Capacitance   | Nominal<br>Cut-off<br>Frequency | Rated<br>Current | New  | Kit | $\geq 1A$ | $\geq 3A$ | $\geq 10A$ | DTV | Flow   | Reflow |        |        |
|---|-----------------------------|-------------------|-----------------------|-----------------------|---------------|---------------------------------|------------------|------|-----|-----------|-----------|------------|-----|--------|--------|--------|--------|
| RC Combined Type<br>for Signal Lines          | 0805<br>(2012)              | p152              | 0.5                   | <b>NFR21GD1002202</b> | 50Vdc         | 10pF+20%-20%                    | -                | 50mA |     |           |           |            |     |        |        | Reflow |        |
|   |                             | 0.5               | <b>NFR21GD1004702</b> | 50Vdc                 | 10pF+20%-20%  | -                               | 35mA             |      |     |           |           |            |     |        |        |        | Reflow |
|   |                             | 0.5               | <b>NFR21GD4702202</b> | 50Vdc                 | 47pF+20%-20%  | -                               | 50mA             |      |     |           |           |            |     |        |        |        | Reflow |
|   |                             | 0.5               | <b>NFR21GD4704702</b> | 50Vdc                 | 47pF+20%-20%  | -                               | 35mA             |      |     |           |           |            |     |        |        |        | Reflow |
|   |                             | 0.5               | <b>NFR21GD4706802</b> | 50Vdc                 | 47pF+20%-20%  | -                               | 30mA             |      |     |           |           |            |     |        |        |        | Reflow |
|   |                             | 0.5               | <b>NFR21GD4701012</b> | 50Vdc                 | 47pF+20%-20%  | -                               | 25mA             |      |     |           |           |            |     |        |        |        | Reflow |
|   |                             | 0.5               | <b>NFR21GD1012202</b> | 50Vdc                 | 100pF+20%-20% | -                               | 50mA             |      |     |           |           |            |     |        |        |        | Reflow |
|   |                             | 0.5               | <b>NFR21GD1014702</b> | 50Vdc                 | 100pF+20%-20% | -                               | 35mA             |      |     |           |           |            |     |        |        |        | Reflow |
|   |                             | 0.5               | <b>NFR21GD1016802</b> | 50Vdc                 | 100pF+20%-20% | -                               | 30mA             |      |     |           |           |            |     |        |        |        | Reflow |
| RC Combined<br>Array Type<br>for Signal Lines | 1206<br>(3216)              | p153              | 0.8                   | <b>NFA31GD1006R84</b> | 6Vdc          | 10pF+20%-20%                    | -                | 50mA |     |           |           |            |     |        |        | Reflow |        |
|   |                             | 0.8               | <b>NFA31GD1004704</b> | 6Vdc                  | 10pF+20%-20%  | -                               | 20mA             |      |     |           |           |            |     |        |        | Reflow |        |
|   |                             | 0.8               | <b>NFA31GD1001014</b> | 6Vdc                  | 10pF+20%-20%  | -                               | 15mA             |      |     |           |           |            |     |        |        | Reflow |        |
|   |                             | 0.8               | <b>NFA31GD4706R84</b> | 6Vdc                  | 47pF+20%-20%  | -                               | 50mA             |      |     |           |           |            |     |        |        | Reflow |        |
|   |                             | 0.8               | <b>NFA31GD4703304</b> | 6Vdc                  | 47pF+20%-20%  | -                               | 20mA             |      |     |           |           |            |     |        |        | Reflow |        |
|   |                             | 0.8               | <b>NFA31GD4704704</b> | 6Vdc                  | 47pF+20%-20%  | -                               | 20mA             |      |     |           |           |            |     |        |        | Reflow |        |
|   |                             | 0.8               | <b>NFA31GD4701014</b> | 6Vdc                  | 47pF+20%-20%  | -                               | 15mA             |      |     |           |           |            |     |        |        | Reflow |        |
|   |                             | 0.8               | <b>NFA31GD1016R84</b> | 6Vdc                  | 100pF+20%-20% | -                               | 50mA             |      |     |           |           |            |     |        |        | Reflow |        |
|   |                             | 0.8               | <b>NFA31GD1014704</b> | 6Vdc                  | 100pF+20%-20% | -                               | 20mA             |      |     |           |           |            |     |        |        | Reflow |        |
| 0.8   | <b>NFA31GD1011014</b>       | 6Vdc              | 100pF+20%-20%         | -                     | 15mA          |                                 |                  |      |     |           |           |            |     | Reflow |        |        |        |

△Note • Please read rating and △CAUTION (for storage, operating, rating, soldering, mounting and handling) in this catalog to prevent smoking and/or burning, etc.  
 • This catalog has only typical specifications. Therefore, please approve our product specifications or transact the approval sheet for product specifications before ordering.

Chip Ferrite Bead

Chip EMIFIL®

Chip Common Mode Choke Coil

Block Type EMIFIL®

Microwave Absorber

# NFE31PT Series 1206/3216 (inch/mm)



Meets 6A, T-type filter with built-in ferrite bead.

### ■ Dimensions

Legend:  Electrode (in mm)

### ■ Equivalent Circuit

### ■ Packaging

| Code | Packaging                | Minimum Quantity |
|------|--------------------------|------------------|
| L    | 180mm Reel Embossed Tape | 2000             |
| K    | 330mm Reel Embossed Tape | 8000             |
| B    | Bulk(Bag)                | 500              |

Refer to pages from p.156 to p.162 for mounting information.

### ■ Rated Value (□: packaging code)

| Part Number     | Capacitance    | Rated Current | Rated Voltage | Insulation Resistance (min.) | Operating Temperature Range |         |
|-----------------|----------------|---------------|---------------|------------------------------|-----------------------------|---------|
| NFE31PT220R1E9□ | 22pF ±30%      | 6A            | 25Vdc         | 1000M ohm                    | -40°C to +85°C              | ≥3A     |
| NFE31PT470C1E9□ | 47pF 50/-20%   | 6A            | 25Vdc         | 1000M ohm                    | -40°C to +85°C              | ≥3A     |
| NFE31PT101C1E9□ | 100pF 80/-20%  | 6A            | 25Vdc         | 1000M ohm                    | -40°C to +85°C              | ≥3A     |
| NFE31PT221D1E9□ | 220pF 50/-20%  | 6A            | 25Vdc         | 1000M ohm                    | -40°C to +85°C              | ≥3A     |
| NFE31PT471F1E9□ | 470pF 50/-20%  | 6A            | 25Vdc         | 1000M ohm                    | -40°C to +85°C              | ≥3A     |
| NFE31PT152Z1E9□ | 1500pF 50/-20% | 6A            | 25Vdc         | 1000M ohm                    | -40°C to +85°C              | Kit ≥3A |
| NFE31PT222Z1E9□ | 2200pF ±50%    | 6A            | 25Vdc         | 1000M ohm                    | -40°C to +85°C              | Kit ≥3A |

Number of Circuit: 1

### ■ Insertion Loss Characteristics

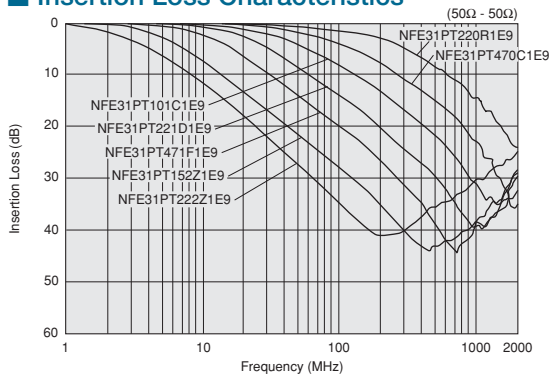

⚠Note • Please read rating and ⚠CAUTION (for storage, operating, rating, soldering, mounting and handling) in this catalog to prevent smoking and/or burning, etc.  
 • This catalog has only typical specifications. Therefore, please approve our product specifications or transact the approval sheet for product specifications before ordering.

Chip Ferrite Bead

Universal Type [Power Lines/Signal Lines] Chip EMIFIL®

Chip Common Mode Choke Coil

Block Type EMIFIL®

Microwave Absorber

# NFE61PT Series 2706/6816 (inch/mm)



## T-type filter with built-in ferrite bead.



### Dimensions

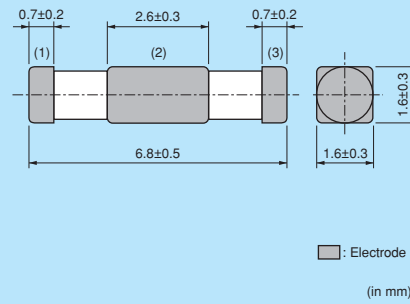

### Equivalent Circuit

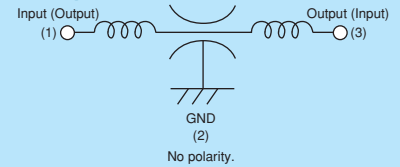

### Packaging

| Code | Packaging                | Minimum Quantity |
|------|--------------------------|------------------|
| L    | 180mm Reel Embossed Tape | 2500             |
| K    | 330mm Reel Embossed Tape | 8000             |
| B    | Bulk(Bag)                | 500              |

Refer to pages from p.156 to p.162 for mounting information.

### Rated Value (□: packaging code)

| Part Number     | Capacitance    | Rated Current | Rated Voltage | Insulation Resistance (min.) | Operating Temperature Range |         |
|-----------------|----------------|---------------|---------------|------------------------------|-----------------------------|---------|
| NFE61PT330B1H9□ | 33pF ±30%      | 2A            | 50Vdc         | 1000M ohm                    | -40°C to +85°C              | ≥1A     |
| NFE61PT680B1H9□ | 68pF ±30%      | 2A            | 50Vdc         | 1000M ohm                    | -40°C to +85°C              | ≥1A     |
| NFE61PT101Z1H9□ | 100pF ±30%     | 2A            | 50Vdc         | 1000M ohm                    | -40°C to +85°C              | ≥1A     |
| NFE61PT181B1H9□ | 180pF ±30%     | 2A            | 50Vdc         | 1000M ohm                    | -40°C to +85°C              | ≥1A     |
| NFE61PT361B1H9□ | 360pF ±20%     | 2A            | 50Vdc         | 1000M ohm                    | -40°C to +85°C              | ≥1A     |
| NFE61PT681B1H9□ | 680pF ±30%     | 2A            | 50Vdc         | 1000M ohm                    | -40°C to +85°C              | ≥1A     |
| NFE61PT102E1H9□ | 1000pF 80/-20% | 2A            | 50Vdc         | 1000M ohm                    | -40°C to +85°C              | Kit ≥1A |
| NFE61PT472C1H9□ | 4700pF 80/-20% | 2A            | 50Vdc         | 1000M ohm                    | -40°C to +85°C              | Kit ≥1A |

Number of Circuit: 1

### Insertion Loss Characteristics

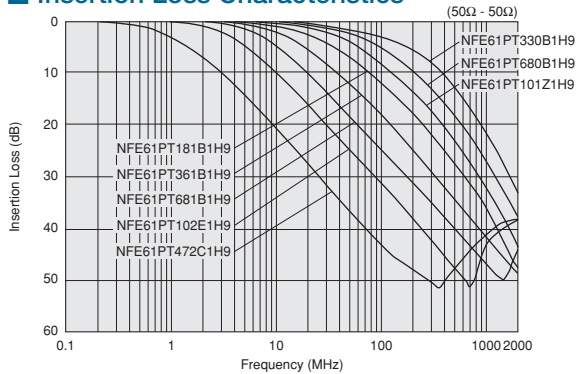

△Note • Please read rating and △CAUTION (for storage, operating, rating, soldering, mounting and handling) in this catalog to prevent smoking and/or burning, etc.  
 • This catalog has only typical specifications. Therefore, please approve our product specifications or transact the approval sheet for product specifications before ordering.

Chip Ferrite Bead

Chip EMIFIL®  
Universal Type [Power Lines/Signal Lines]

Chip Common Mode Choke Coil

Block Type EMIFIL®

Microwave Absorber

# NFM15PC Series 0402/1005 (inch/mm)



0402 size chip 3-terminal capacitor for power lines.

**NFM15PC** (0.047, 0.1, 0.22, 4.3μF)

**■ Dimensions**

(in mm)

**■ Equivalent Circuit**

No polarity.

**■ Packaging**

| Code | Packaging             | Minimum Quantity |
|------|-----------------------|------------------|
| D    | 180mm Reel Paper Tape | 10000            |
| B    | Bulk(Bag)             | 500              |

**NFM15PCC** (0.47 to 1μF)

**■ Dimensions**

(in mm)

**■ Equivalent Circuit**

No polarity.

**■ Packaging**

| Code | Packaging             | Minimum Quantity |
|------|-----------------------|------------------|
| D    | 180mm Reel Paper Tape | 10000            |
| B    | Bulk(Bag)             | 500              |

Refer to pages from p.156 to p.162 for mounting information.

**■ Rated Value** (□: packaging code)

| Part Number     | Capacitance  | Rated Current | Rated Voltage | Insulation Resistance (min.) | Operating Temperature Range |             |
|-----------------|--------------|---------------|---------------|------------------------------|-----------------------------|-------------|
| NFM15PC473C1A3□ | 0.047μF ±20% | 1A            | 10Vdc         | 1000M ohm                    | -55°C to +105°C             | New Kit ≥1A |
| NFM15PC473C1C3□ | 0.047μF ±20% | 1A            | 16Vdc         | 1000M ohm                    | -55°C to +85°C              | New Kit ≥1A |
| NFM15PC104D0J3□ | 0.1μF ±20%   | 2A            | 6.3Vdc        | 1000M ohm                    | -55°C to +105°C             | New Kit ≥1A |
| NFM15PC104R1A3□ | 0.1μF ±20%   | 2A            | 10Vdc         | 1000M ohm                    | -55°C to +85°C              | New Kit ≥1A |
| NFM15PC224D0J3□ | 0.22μF ±20%  | 2A            | 6.3Vdc        | 1000M ohm                    | -55°C to +105°C             | New Kit ≥1A |
| NFM15PC224R1A3□ | 0.22μF ±20%  | 2A            | 10Vdc         | 1000M ohm                    | -55°C to +85°C              | New Kit ≥1A |
| NFM15PC474D0G3□ | 0.47μF ±20%  | 2A            | 4Vdc          | 1000M ohm                    | -55°C to +105°C             | New Kit ≥1A |
| NFM15PC474R0J3□ | 0.47μF ±20%  | 2A            | 6.3Vdc        | 1000M ohm                    | -55°C to +85°C              | New Kit ≥1A |
| NFM15PC105R0G3□ | 1μF ±20%     | 2A            | 4Vdc          | 500M ohm                     | -55°C to +85°C              | New Kit ≥1A |
| NFM15PC435R0E3□ | 4.3μF ±20%   | 2A            | 2.5Vdc        | 25M ohm                      | -55°C to +85°C              | New Kit ≥1A |

Number of Circuit: 1

Continued on the following page.

△Note • Please read rating and △CAUTION (for storage, operating, rating, soldering, mounting and handling) in this catalog to prevent smoking and/or burning, etc.  
 • This catalog has only typical specifications. Therefore, please approve our product specifications or transact the approval sheet for product specifications before ordering.

■ Insertion Loss Characteristics

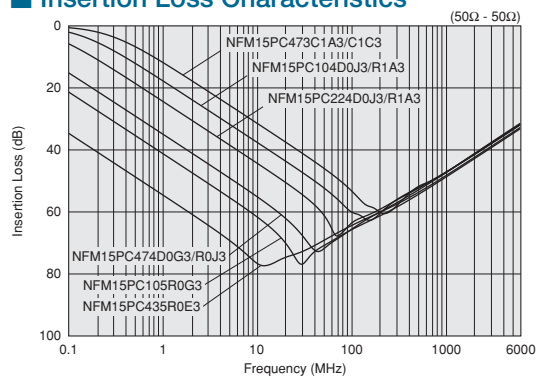

Chip Ferrite Bead

Chip EMIFIL®  
 Power Lines Type

Chip Common Mode Choke Coil

Block Type EMIFIL®

Microwave Absorber

⚠Note • Please read rating and ⚠CAUTION (for storage, operating, rating, soldering, mounting and handling) in this catalog to prevent smoking and/or burning, etc.  
 • This catalog has only typical specifications. Therefore, please approve our product specifications or transact the approval sheet for product specifications before ordering.

# NFM18PS Series 0603/1608 (inch/mm)



3-terminal capacitor for power lines whose ground impedance has reduced.

\*Please refer to the products designed for both power lines and signal lines.

### ■ Dimensions

(in mm)

### ■ Equivalent Circuit

No polarity.

### ■ Packaging

| Code | Packaging             | Minimum Quantity |
|------|-----------------------|------------------|
| D    | 180mm Reel Paper Tape | 4000             |
| B    | Bulk(Bag)             | 500              |

Refer to pages from p.156 to p.162 for mounting information.

### ■ Rated Value (□: packaging code)

| Part Number     | Capacitance | Rated Current | Rated Voltage | Insulation Resistance (min.) | Operating Temperature Range |             |
|-----------------|-------------|---------------|---------------|------------------------------|-----------------------------|-------------|
| NFM18PS474R0J3□ | 0.47μF ±20% | 2A            | 6.3Vdc        | 1000M ohm                    | -55°C to +125°C             | Kit ≥1A     |
| NFM18PS105D0J3□ | 1.0μF ±20%  | 2A            | 6.3Vdc        | 500M ohm                     | -55°C to +125°C             | New Kit ≥1A |
| NFM18PS105R0J3□ | 1.0μF ±20%  | 2A            | 6.3Vdc        | 500M ohm                     | -55°C to +105°C             | Kit ≥1A     |

Number of Circuit: 1

### ■ Insertion Loss Characteristics

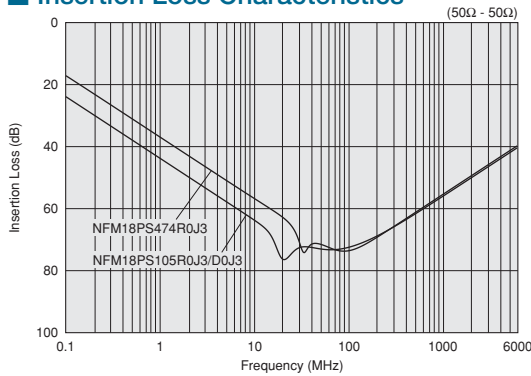

⚠Note • Please read rating and ⚠CAUTION (for storage, operating, rating, soldering, mounting and handling) in this catalog to prevent smoking and/or burning, etc.  
 • This catalog has only typical specifications. Therefore, please approve our product specifications or transact the approval sheet for product specifications before ordering.

# NFM18PC Series 0603/1608 (inch/mm)



## 4A max., 0603 size chip 3-terminal capacitor for power lines.

\*Please refer to the products designed for both power lines and signal lines.

Chip Ferrite Bead

Chip EMIFIL®  
Power Lines Type

Chip Common Mode Choke Coil

Block Type EMIFIL®

Microwave Absorber

### NFM18PC (0.1 to 0.47μF, 2.2μF - 6.3V)



#### ■ Dimensions

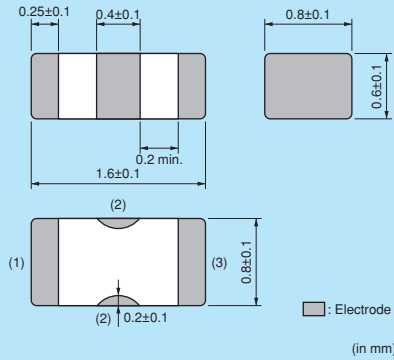

#### ■ Equivalent Circuit

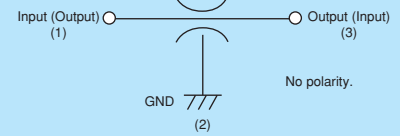

#### ■ Packaging

| Code | Packaging             | Minimum Quantity |
|------|-----------------------|------------------|
| D    | 180mm Reel Paper Tape | 4000             |
| B    | Bulk(Bag)             | 500              |

### NFM18PC (1μF, 2.2μF - 10V)



#### ■ Dimensions

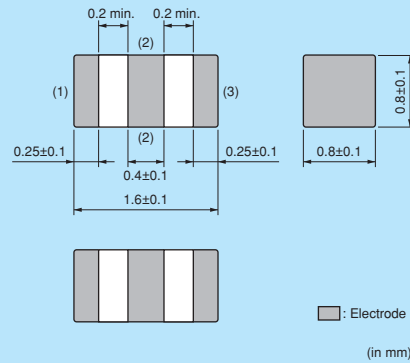

#### ■ Equivalent Circuit

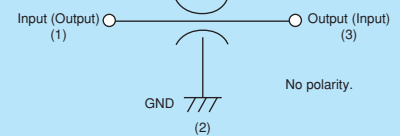

#### ■ Packaging

| Code | Packaging             | Minimum Quantity |
|------|-----------------------|------------------|
| D    | 180mm Reel Paper Tape | 4000             |
| B    | Bulk(Bag)             | 500              |

Refer to pages from p.156 to p.162 for mounting information.

### ■ Rated Value (□: packaging code)

| Part Number     | Capacitance | Rated Current | Rated Voltage | Insulation Resistance (min.) | Operating Temperature Range |         |
|-----------------|-------------|---------------|---------------|------------------------------|-----------------------------|---------|
| NFM18PC104R1C3□ | 0.1μF ±20%  | 2A            | 16Vdc         | 1000M ohm                    | -55°C to +125°C             | Kit ≥1A |
| NFM18PC224R0J3□ | 0.22μF ±20% | 2A            | 6.3Vdc        | 1000M ohm                    | -55°C to +125°C             | Kit ≥1A |
| NFM18PC474R0J3□ | 0.47μF ±20% | 2A            | 6.3Vdc        | 1000M ohm                    | -55°C to +125°C             | Kit ≥1A |
| NFM18PC105R0J3□ | 1.0μF ±20%  | 4A            | 6.3Vdc        | 500M ohm                     | -55°C to +105°C             | Kit ≥1A |
| NFM18PC225B0J3□ | 2.2μF ±20%  | 2A            | 6.3Vdc        | 200M ohm                     | -40°C to +85°C              | Kit ≥1A |
| NFM18PC225B1A3□ | 2.2μF ±20%  | 4A            | 10Vdc         | 200M ohm                     | -40°C to +85°C              | Kit ≥3A |

Number of Circuit: 1

### ■ Insertion Loss Characteristics

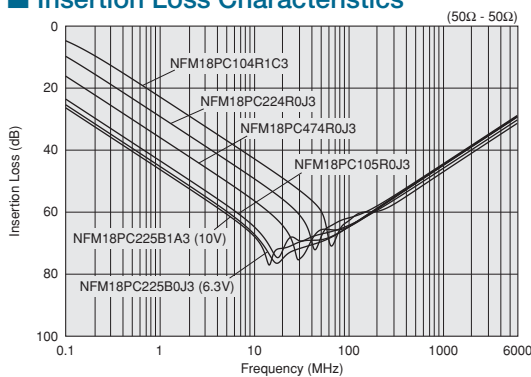

△Note • Please read rating and △CAUTION (for storage, operating, rating, soldering, mounting and handling) in this catalog to prevent smoking and/or burning, etc.  
 • This catalog has only typical specifications. Therefore, please approve our product specifications or transact the approval sheet for product specifications before ordering.



• High frequency performance of NFM18PS series

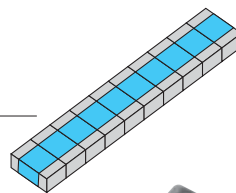
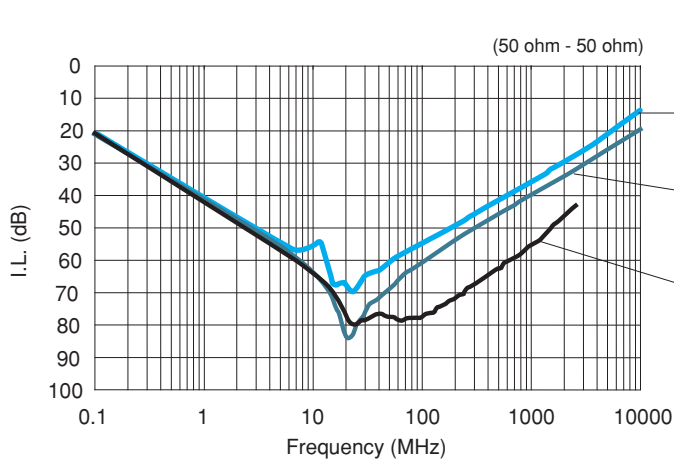

Chip 3-terminal capacitor

2 terminal MLCC: 2012mm size  
(0.1μF×10pcs parallel)

NFM18PC105R0J3 1pc  
: 1608mm size (1.0μF×1)

NFM18PS105R0J3 1pc  
: 1608mm size (1.0μF×1)

NFM18PS series has better high-frequency performance compared to normal chip 3 terminal capacitors.

• Optimize of bypass capacitors using chip 3-terminal capacitor

Number of parts can be reduced.  
⇒ • Reduce PCB space  
• Reduce mount cost

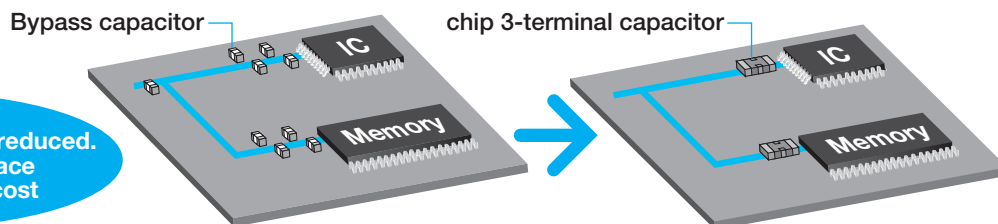

Comparison of performance as a bypass capacitor

Without capacitor

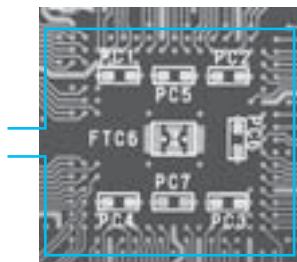

Micro computer

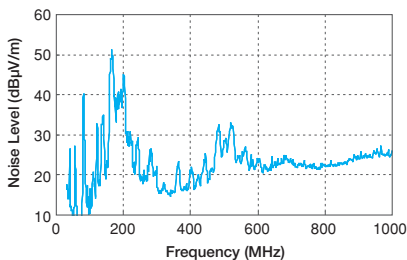
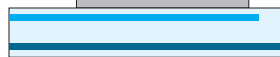

With MLCC 0.22μF×4

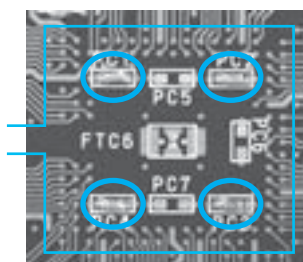

Micro computer

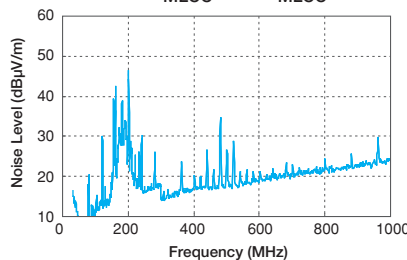
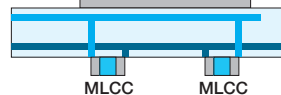

With chip 3-terminal capacitor (NFM) 1μF×1

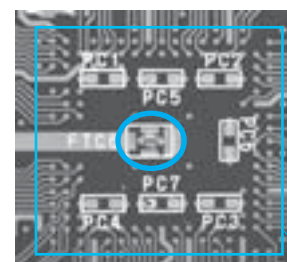

Micro computer

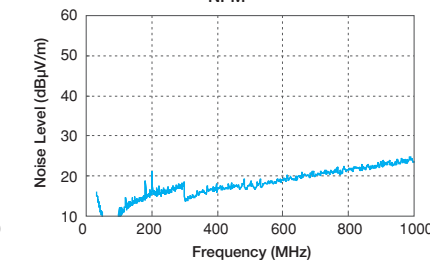
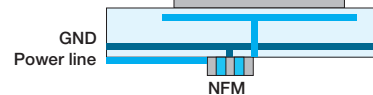

Noise suppression effect of NFM series is better than MLCCs (1 NFM is better than 4 MLCCs).

△Note • Please read rating and △CAUTION (for storage, operating, rating, soldering, mounting and handling) in this catalog to prevent smoking and/or burning, etc.  
• This catalog has only typical specifications. Therefore, please approve our product specifications or transact the approval sheet for product specifications before ordering.

# NFM21PS Series 0805/2012 (inch/mm)



0805 size 3-terminal capacitor with very low ground impedance.



### ■ Dimensions

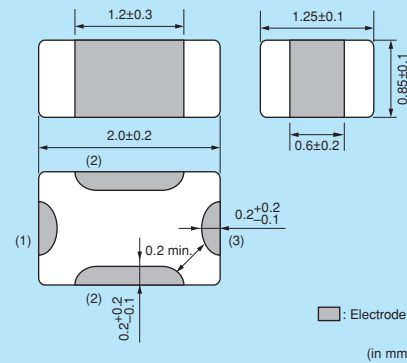

### ■ Equivalent Circuit

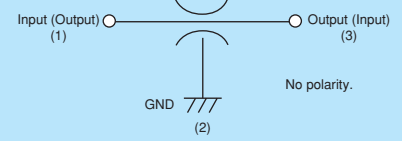

### ■ Packaging

| Code | Packaging             | Minimum Quantity |
|------|-----------------------|------------------|
| D    | 180mm Reel Paper Tape | 4000             |
| B    | Bulk(Bag)             | 500              |

Refer to pages from p.156 to p.162 for mounting information.

### ■ Rated Value (□: packaging code)

| Part Number     | Capacitance | Rated Current | Rated Voltage | Insulation Resistance (min.) | Operating Temperature Range |         |
|-----------------|-------------|---------------|---------------|------------------------------|-----------------------------|---------|
| NFM21PS106B0J3□ | 10μF ±20%   | 4A            | 6.3Vdc        | 50M ohm                      | -40°C to +85°C              | Kit ≥3A |

Number of Circuit: 1

### ■ Insertion Loss Characteristics

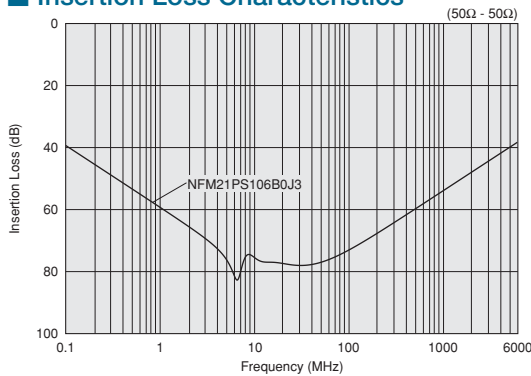

⚠Note • Please read rating and ⚠CAUTION (for storage, operating, rating, soldering, mounting and handling) in this catalog to prevent smoking and/or burning, etc.  
 • This catalog has only typical specifications. Therefore, please approve our product specifications or transact the approval sheet for product specifications before ordering.

Chip Ferrite Bead  
Chip EMIFIL® Power Lines Type  
Chip Common Mode Choke Coil  
Block Type EMIFIL®  
Microwave Absorber

# NFM21PC Series 0805/2012 (inch/mm)



## 6A max., 0805 size chip 3-terminal capacitor for power lines.

\*Please refer to the products designed for both power lines and signal lines.



### ■ Dimensions

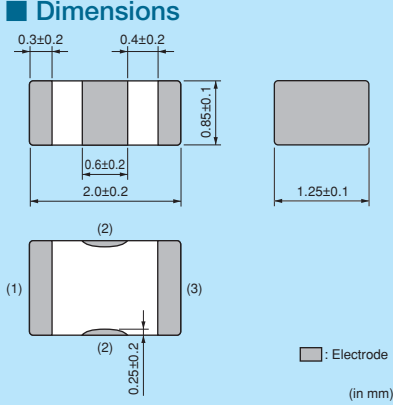

(in mm)

### ■ Equivalent Circuit

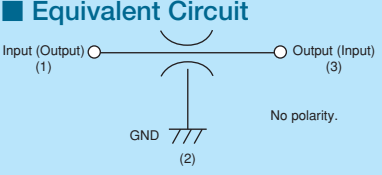

No polarity.

### ■ Packaging

| Code | Packaging             | Minimum Quantity |
|------|-----------------------|------------------|
| D    | 180mm Reel Paper Tape | 4000             |
| B    | Bulk(Bag)             | 500              |

Refer to pages from p.156 to p.162 for mounting information.

### ■ Rated Value (□: packaging code)

| Part Number     | Capacitance | Rated Current | Rated Voltage | Insulation Resistance (min.) | Operating Temperature Range |         |
|-----------------|-------------|---------------|---------------|------------------------------|-----------------------------|---------|
| NFM21PC104R1E3□ | 0.1μF ±20%  | 2A            | 25Vdc         | 1000M ohm                    | -55°C to +125°C             | Kit ≥1A |
| NFM21PC224R1C3□ | 0.22μF ±20% | 2A            | 16Vdc         | 1000M ohm                    | -55°C to +125°C             | Kit ≥1A |
| NFM21PC474R1C3□ | 0.47μF ±20% | 2A            | 16Vdc         | 1000M ohm                    | -55°C to +125°C             | Kit ≥1A |
| NFM21PC105B1A3□ | 1.0μF ±20%  | 4A            | 10Vdc         | 500M ohm                     | -40°C to +85°C              | Kit ≥3A |
| NFM21PC105B1C3□ | 1.0μF ±20%  | 4A            | 16Vdc         | 500M ohm                     | -40°C to +85°C              | Kit ≥3A |
| NFM21PC225B0J3□ | 2.2μF ±20%  | 4A            | 6.3Vdc        | 200M ohm                     | -40°C to +85°C              | Kit ≥3A |
| NFM21PC475B1A3□ | 4.7μF ±20%  | 6A            | 10Vdc         | 100M ohm                     | -40°C to +85°C              | Kit ≥3A |

Number of Circuit: 1

### ■ Insertion Loss Characteristics

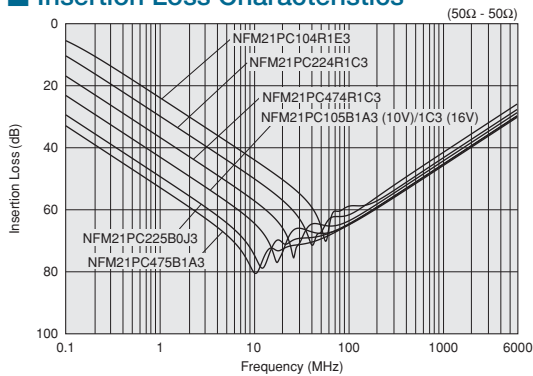

⚠Note • Please read rating and ⚠CAUTION (for storage, operating, rating, soldering, mounting and handling) in this catalog to prevent smoking and/or burning, etc.  
 • This catalog has only typical specifications. Therefore, please approve our product specifications or transact the approval sheet for product specifications before ordering.

# NFM3DPC Series 1205/3212 (inch/mm)



## 1205 size 3-terminal capacitor for power lines.

\*Please refer to the products designed for both power lines and signal lines.



### ■ Dimensions

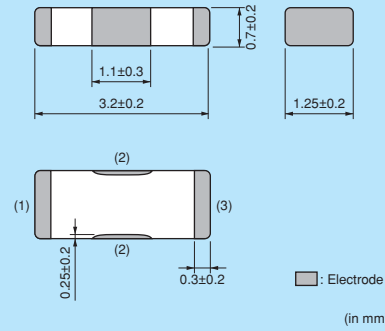

### ■ Equivalent Circuit

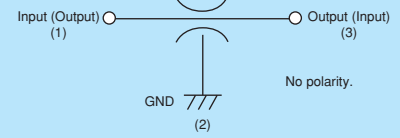

### ■ Packaging

| Code | Packaging                | Minimum Quantity |
|------|--------------------------|------------------|
| L    | 180mm Reel Embossed Tape | 4000             |
| B    | Bulk(Bag)                | 500              |

Refer to pages from p.156 to p.162 for mounting information.

### ■ Rated Value (□: packaging code)

| Part Number     | Capacitance  | Rated Current | Rated Voltage | Insulation Resistance (min.) | Operating Temperature Range |     |
|-----------------|--------------|---------------|---------------|------------------------------|-----------------------------|-----|
| NFM3DPC223R1H3□ | 0.022μF ±20% | 2A            | 50Vdc         | 1000M ohm                    | -55°C to +125°C             | ≥1A |

Number of Circuit: 1

### ■ Insertion Loss Characteristics

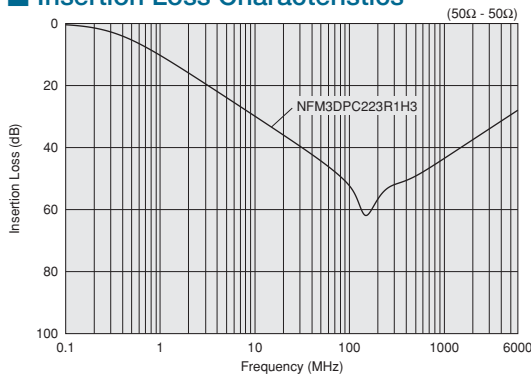

### ■ Notice (Rating)

When NFM3DPC series is used in operating temperature exceeding +85°C, derating of current is necessary. Please apply the derating curve shown in chart according to the operating temperature.

#### Derating of Rated Current

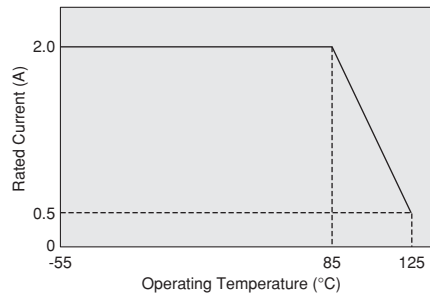

△Note • Please read rating and △CAUTION (for storage, operating, rating, soldering, mounting and handling) in this catalog to prevent smoking and/or burning, etc.  
 • This catalog has only typical specifications. Therefore, please approve our product specifications or transact the approval sheet for product specifications before ordering.

Chip Ferrite Bead  
Chip EMIFIL® Power Lines Type  
Chip Common Mode Choke Coil  
Block Type EMIFIL®  
Microwave Absorber

# NFM31PC Series 1206/3216 (inch/mm)



6A/27microF, 1206 size chip 3-terminal capacitor for power lines.

\*Please refer to the products designed for both power lines and signal lines.

### ■ Dimensions

0.4±0.3, 1.1±0.3, 0.4±0.3, 3.2±0.2, 1.6±0.2, 1.3±0.2, 1.6±0.2, 0.3±0.2

Legend:  Electrode (in mm)

### ■ Equivalent Circuit

Input (Output) (1) — Capacitor — Output (Input) (3)  
GND (2)

No polarity.

### ■ Packaging

| Code | Packaging                | Minimum Quantity |
|------|--------------------------|------------------|
| L    | 180mm Reel Embossed Tape | 3000             |
| B    | Bulk(Bag)                | 500              |

Refer to pages from p.156 to p.162 for mounting information.

### ■ Rated Value (□: packaging code)

| Part Number     | Capacitance | Rated Current | Rated Voltage | Insulation Resistance (min.) | Operating Temperature Range |         |
|-----------------|-------------|---------------|---------------|------------------------------|-----------------------------|---------|
| NFM31PC276B0J3□ | 27μF ±20%   | 6A            | 6.3Vdc        | 20M ohm                      | -40°C to +85°C              | Kit ≥3A |

Number of Circuit: 1

### ■ Insertion Loss Characteristics

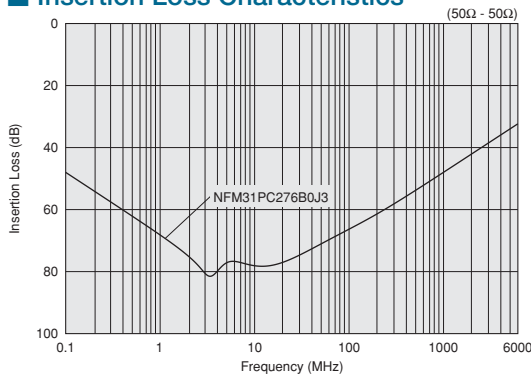

⚠Note • Please read rating and ⚠CAUTION (for storage, operating, rating, soldering, mounting and handling) in this catalog to prevent smoking and/or burning, etc.  
• This catalog has only typical specifications. Therefore, please approve our product specifications or transact the approval sheet for product specifications before ordering.

# NFM31KC Series 1206/3216 (inch/mm)



Capable for 10A max. Large current 3-terminal capacitor.



### Dimensions

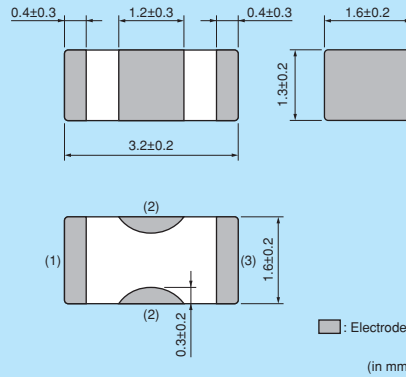

### Equivalent Circuit

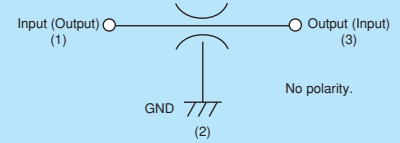

### Packaging

| Code | Packaging                | Minimum Quantity |
|------|--------------------------|------------------|
| L    | 180mm Reel Embossed Tape | 3000             |
| B    | Bulk(Bag)                | 500              |

Refer to pages from p.156 to p.162 for mounting information.

### Rated Value (□: packaging code)

| Part Number     | Capacitance   | Rated Current | Rated Voltage | Insulation Resistance (min.) | Operating Temperature Range | Kit | Current |
|-----------------|---------------|---------------|---------------|------------------------------|-----------------------------|-----|---------|
| NFM31KC103R1H3□ | 10000pF ±20%  | 10A           | 50Vdc         | 1000M ohm                    | -55°C to +125°C             | Kit | ≥10A    |
| NFM31KC103R2A3□ | 10000pF ±20%  | 10A           | 100Vdc        | 1000M ohm                    | -55°C to +125°C             | Kit | ≥10A    |
| NFM31KC153R1H3□ | 15000pF ±20%  | 10A           | 50Vdc         | 1000M ohm                    | -55°C to +125°C             | Kit | ≥10A    |
| NFM31KC153R2A3□ | 15000pF ±20%  | 10A           | 100Vdc        | 1000M ohm                    | -55°C to +105°C             | Kit | ≥10A    |
| NFM31KC223R1H3□ | 22000pF ±20%  | 10A           | 50Vdc         | 1000M ohm                    | -55°C to +125°C             | Kit | ≥10A    |
| NFM31KC223R2A3□ | 22000pF ±20%  | 10A           | 100Vdc        | 1000M ohm                    | -55°C to +105°C             | Kit | ≥10A    |
| NFM31KC104R1H3□ | 100000pF ±20% | 6A            | 50Vdc         | 1000M ohm                    | -55°C to +125°C             | Kit | ≥3A     |
| NFM31KC104R2A3□ | 100000pF ±20% | 6A            | 100Vdc        | 1000M ohm                    | -55°C to +105°C             | Kit | ≥3A     |

Number of Circuit: 1

### Insertion Loss Characteristics

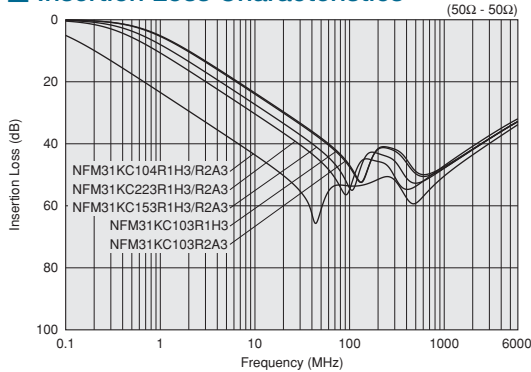

### Notice (Rating)

When NFM31KC series is used in operating temperatures exceeding +105°C, derating of current is necessary. Please apply the derating curve shown in chart according to the operating temperature.

Derating of Rated Current  
(Except for NFM31KC 153/223/104 R2A3, NFM31KC104R1H3)

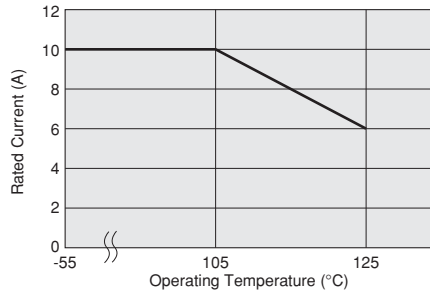

△Note • Please read rating and △CAUTION (for storage, operating, rating, soldering, mounting and handling) in this catalog to prevent smoking and/or burning, etc.  
• This catalog has only typical specifications. Therefore, please approve our product specifications or transact the approval sheet for product specifications before ordering.

Chip Ferrite Bead  
Chip EMIFIL® Power Lines Type  
Chip Common Mode Choke Coil  
Block Type EMIFIL®  
Microwave Absorber

# NFM41PC Series 1806/4516 (inch/mm)



## 6A max., 1806 size chip 3-terminal capacitor for power lines.

\*Please refer to the products designed for both power lines and signal lines.

### ■ Dimensions

(in mm)

### ■ Equivalent Circuit

No polarity.

### ■ Packaging

| Code | Packaging                | Minimum Quantity |
|------|--------------------------|------------------|
| L    | 180mm Reel Embossed Tape | 4000             |
| B    | Bulk(Bag)                | 500              |

Refer to pages from p.156 to p.162 for mounting information.

### ■ Rated Value (□: packaging code)

| Part Number     | Capacitance   | Rated Current | Rated Voltage | Insulation Resistance (min.) | Operating Temperature Range |             |
|-----------------|---------------|---------------|---------------|------------------------------|-----------------------------|-------------|
| NFM41PC204F1H3□ | 0.2μF 80/-20% | 2A            | 50Vdc         | 1000M ohm                    | -55°C to +85°C              | Kit ≥1A     |
| NFM41PC155B1E3□ | 1.5μF ±20%    | 6A            | 25Vdc         | 300M ohm                     | -55°C to +85°C              | Kit ≥3A     |
| NFM41PC155B1H3□ | 1.5μF ±20%    | 6A            | 50Vdc         | 100M ohm                     | -55°C to +85°C              | New Kit ≥3A |

Number of Circuit: 1

### ■ Insertion Loss Characteristics

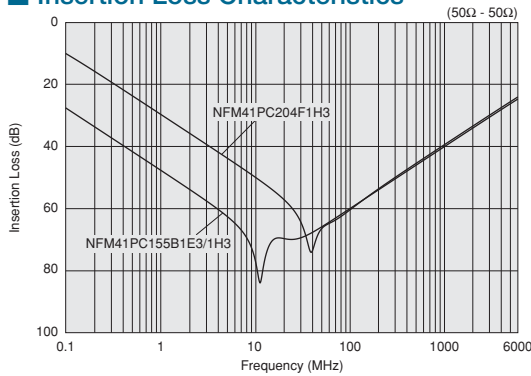

⚠Note • Please read rating and ⚠CAUTION (for storage, operating, rating, soldering, mounting and handling) in this catalog to prevent smoking and/or burning, etc.  
 • This catalog has only typical specifications. Therefore, please approve our product specifications or transact the approval sheet for product specifications before ordering.

# NFM15CC Series 0402/1005 (inch/mm)



0402 size chip 3-terminal capacitor for signal lines.

### ■ Dimensions

0.17±0.1, 0.35±0.1, 1.0±0.1, 0.5±0.2, 0.4±0.1, 0.5±0.2, 0.15±0.1

■: Electrode (in mm)

### ■ Equivalent Circuit

Input (Output) (1) — Output (Input) (3)  
GND (2)  
No polarity.

### ■ Packaging

| Code | Packaging             | Minimum Quantity |
|------|-----------------------|------------------|
| D    | 180mm Reel Paper Tape | 10000            |
| B    | Bulk(Bag)             | 500              |

Refer to pages from p.156 to p.162 for mounting information.

### ■ Rated Value (□: packaging code)

| Part Number     | Capacitance  | Rated Current | Rated Voltage | Insulation Resistance (min.) | Operating Temperature Range |             |
|-----------------|--------------|---------------|---------------|------------------------------|-----------------------------|-------------|
| NFM15CC222D1A3□ | 2200pF ±20%  | 1A            | 10Vdc         | 1000M ohm                    | -55°C to +105°C             | New Kit ≥1A |
| NFM15CC222D1C3□ | 2200pF ±20%  | 1A            | 16Vdc         | 1000M ohm                    | -55°C to +85°C              | New Kit ≥1A |
| NFM15CC223C1A3□ | 22000pF ±20% | 1A            | 10Vdc         | 1000M ohm                    | -55°C to +105°C             | New Kit ≥1A |
| NFM15CC223C1C3□ | 22000pF ±20% | 1A            | 16Vdc         | 1000M ohm                    | -55°C to +85°C              | New Kit ≥1A |

Number of Circuit: 1

### ■ Insertion Loss Characteristics

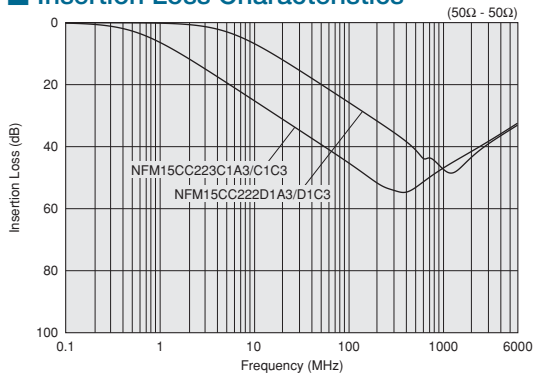

⚠Note • Please read rating and ⚠CAUTION (for storage, operating, rating, soldering, mounting and handling) in this catalog to prevent smoking and/or burning, etc.  
• This catalog has only typical specifications. Therefore, please approve our product specifications or transact the approval sheet for product specifications before ordering.

Chip Ferrite Bead

Chip EMIFIL®  
Signal Lines Type

Chip Common Mode Choke Coil

Block Type EMIFIL®

Microwave Absorber



# NFM18CC Series 0603/1608 (inch/mm)



## 0603 size general 3-terminal capacitor.

### ■ Dimensions

(in mm)

### ■ Equivalent Circuit

No polarity.

### ■ Packaging

| Code | Packaging             | Minimum Quantity |
|------|-----------------------|------------------|
| D    | 180mm Reel Paper Tape | 4000             |
| B    | Bulk(Bag)             | 500              |

Refer to pages from p.156 to p.162 for mounting information.

### ■ Rated Value (□: packaging code)

| Part Number     | Capacitance  | Rated Current | Rated Voltage | Insulation Resistance (min.) | Operating Temperature Range |         |
|-----------------|--------------|---------------|---------------|------------------------------|-----------------------------|---------|
| NFM18CC220U1C3□ | 22pF ±20%    | 400mA         | 16Vdc         | 1000M ohm                    | -55°C to +125°C             | Kit     |
| NFM18CC470U1C3□ | 47pF ±20%    | 400mA         | 16Vdc         | 1000M ohm                    | -55°C to +125°C             | Kit     |
| NFM18CC101R1C3□ | 100pF ±20%   | 500mA         | 16Vdc         | 1000M ohm                    | -55°C to +125°C             | Kit     |
| NFM18CC221R1C3□ | 220pF ±20%   | 500mA         | 16Vdc         | 1000M ohm                    | -55°C to +125°C             | Kit     |
| NFM18CC471R1C3□ | 470pF ±20%   | 500mA         | 16Vdc         | 1000M ohm                    | -55°C to +125°C             | Kit     |
| NFM18CC102R1C3□ | 1000pF ±20%  | 600mA         | 16Vdc         | 1000M ohm                    | -55°C to +125°C             | Kit     |
| NFM18CC222R1C3□ | 2200pF ±20%  | 700mA         | 16Vdc         | 1000M ohm                    | -55°C to +125°C             | Kit     |
| NFM18CC223R1C3□ | 22000pF ±20% | 1000mA        | 16Vdc         | 1000M ohm                    | -55°C to +125°C             | Kit ≥1A |

Number of Circuit: 1

### ■ Insertion Loss Characteristics

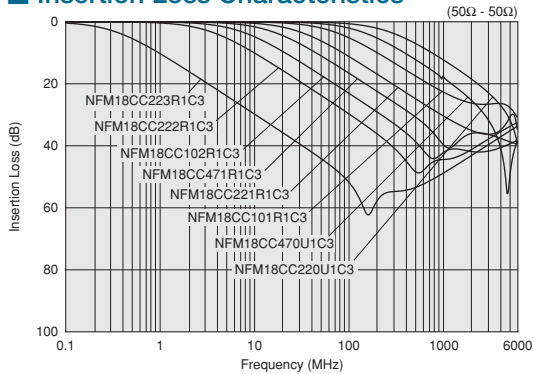

⚠Note • Please read rating and ⚠CAUTION (for storage, operating, rating, soldering, mounting and handling) in this catalog to prevent smoking and/or burning, etc.  
 • This catalog has only typical specifications. Therefore, please approve our product specifications or transact the approval sheet for product specifications before ordering.

# NFM21CC Series 0805/2012 (inch/mm)



0805 size general 3-terminal capacitor.

### ■ Dimensions

0.3±0.2  
0.85±0.1  
0.6±0.2  
2.0±0.2  
1.25±0.1  
0.2±0.2  
-0.1

(1) (2) (3)

□ : Electrode (in mm)

### ■ Equivalent Circuit

Input (Output) (1) ———— Output (Input) (3)  
GND (2)

No polarity.

### ■ Packaging

| Code | Packaging             | Minimum Quantity |
|------|-----------------------|------------------|
| D    | 180mm Reel Paper Tape | 4000             |
| B    | Bulk (Bag)            | 500              |

Refer to pages from p.156 to p.162 for mounting information.

### ■ Rated Value (□: packaging code)

| Part Number     | Capacitance  | Rated Current | Rated Voltage | Insulation Resistance (min.) | Operating Temperature Range |         |
|-----------------|--------------|---------------|---------------|------------------------------|-----------------------------|---------|
| NFM21CC220U1H3□ | 22pF ±20%    | 700mA         | 50Vdc         | 1000M ohm                    | -55°C to +125°C             | Kit     |
| NFM21CC470U1H3□ | 47pF ±20%    | 700mA         | 50Vdc         | 1000M ohm                    | -55°C to +125°C             | Kit     |
| NFM21CC101U1H3□ | 100pF ±20%   | 700mA         | 50Vdc         | 1000M ohm                    | -55°C to +125°C             | Kit     |
| NFM21CC221R1H3□ | 220pF ±20%   | 700mA         | 50Vdc         | 1000M ohm                    | -55°C to +125°C             | Kit     |
| NFM21CC471R1H3□ | 470pF ±20%   | 1000mA        | 50Vdc         | 1000M ohm                    | -55°C to +125°C             | Kit ≥1A |
| NFM21CC102R1H3□ | 1000pF ±20%  | 1000mA        | 50Vdc         | 1000M ohm                    | -55°C to +125°C             | Kit ≥1A |
| NFM21CC222R1H3□ | 2200pF ±20%  | 1000mA        | 50Vdc         | 1000M ohm                    | -55°C to +125°C             | Kit ≥1A |
| NFM21CC223R1H3□ | 22000pF ±20% | 2000mA        | 50Vdc         | 1000M ohm                    | -55°C to +125°C             | Kit ≥1A |

Number of Circuit: 1

### ■ Insertion Loss Characteristics

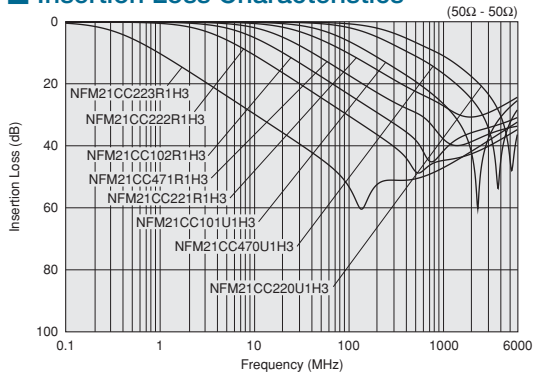

△Note • Please read rating and △CAUTION (for storage, operating, rating, soldering, mounting and handling) in this catalog to prevent smoking and/or burning, etc.  
• This catalog has only typical specifications. Therefore, please approve our product specifications or transact the approval sheet for product specifications before ordering.

Chip Ferrite Bead  
Chip EMIFIL® Signal Lines Type  
Chip Common Mode Choke Coil  
Block Type EMIFIL®  
Microwave Absorber

# NFM3DCC Series 1205/3212 (inch/mm)



## 1205 size general 3-terminal capacitor.



### ■ Dimensions

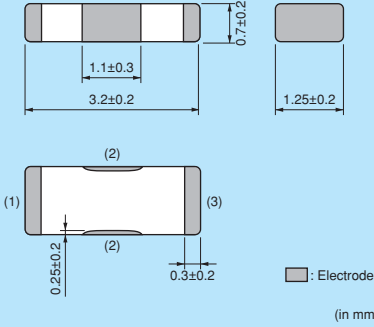

(in mm)

### ■ Equivalent Circuit

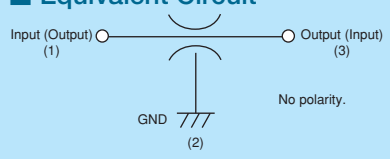

No polarity.

### ■ Packaging

| Code | Packaging                | Minimum Quantity |
|------|--------------------------|------------------|
| L    | 180mm Reel Embossed Tape | 4000             |
| B    | Bulk(Bag)                | 500              |

Refer to pages from p.156 to p.162 for mounting information.

### ■ Rated Value (□: packaging code)

| Part Number     | Capacitance      | Rated Current | Rated Voltage | Insulation Resistance (min.) | Operating Temperature Range |
|-----------------|------------------|---------------|---------------|------------------------------|-----------------------------|
| NFM3DCC220U1H3□ | 22pF +50/-20%    | 300mA         | 50Vdc         | 1000M ohm                    | -55°C to +125°C             |
| NFM3DCC470U1H3□ | 47pF +50/-20%    | 300mA         | 50Vdc         | 1000M ohm                    | -55°C to +125°C             |
| NFM3DCC101U1H3□ | 100pF +50/-20%   | 300mA         | 50Vdc         | 1000M ohm                    | -55°C to +125°C             |
| NFM3DCC221R1H3□ | 220pF +50/-20%   | 300mA         | 50Vdc         | 1000M ohm                    | -55°C to +125°C             |
| NFM3DCC471R1H3□ | 470pF +50/-20%   | 300mA         | 50Vdc         | 1000M ohm                    | -55°C to +125°C             |
| NFM3DCC102R1H3□ | 1000pF +50/-20%  | 300mA         | 50Vdc         | 1000M ohm                    | -55°C to +125°C             |
| NFM3DCC222R1H3□ | 2200pF +50/-20%  | 300mA         | 50Vdc         | 1000M ohm                    | -55°C to +125°C             |
| NFM3DCC223R1H3□ | 22000pF +50/-20% | 300mA         | 50Vdc         | 1000M ohm                    | -55°C to +125°C             |

Number of Circuit: 1

### ■ Insertion Loss Characteristics

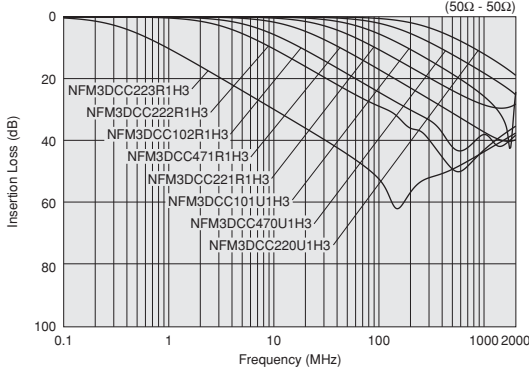

⚠Note • Please read rating and ⚠CAUTION (for storage, operating, rating, soldering, mounting and handling) in this catalog to prevent smoking and/or burning, etc.  
 • This catalog has only typical specifications. Therefore, please approve our product specifications or transact the approval sheet for product specifications before ordering.

# NFM41CC Series 1806/4516 (inch/mm)



## 1806 size general 3-terminal capacitor.



### ■ Dimensions

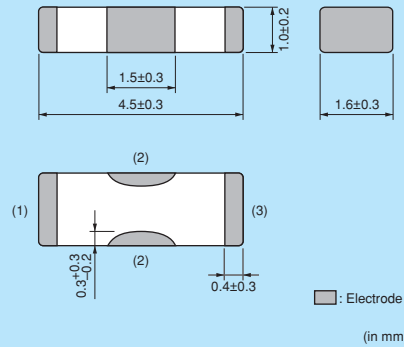

### ■ Equivalent Circuit

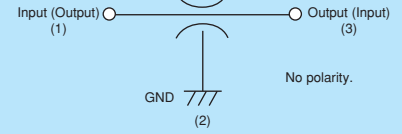

### ■ Packaging

| Code | Packaging                | Minimum Quantity |
|------|--------------------------|------------------|
| L    | 180mm Reel Embossed Tape | 4000             |
| B    | Bulk(Bag)                | 500              |

Refer to pages from p.156 to p.162 for mounting information.

### ■ Rated Value (□: packaging code)

| Part Number     | Capacitance      | Rated Current | Rated Voltage | Insulation Resistance (min.) | Operating Temperature Range |
|-----------------|------------------|---------------|---------------|------------------------------|-----------------------------|
| NFM41CC220U2A3□ | 22pF +50/-20%    | 300mA         | 100Vdc        | 10000M ohm                   | -55°C to +125°C             |
| NFM41CC470U2A3□ | 47pF +50/-20%    | 300mA         | 100Vdc        | 10000M ohm                   | -55°C to +125°C             |
| NFM41CC101U2A3□ | 100pF +50/-20%   | 300mA         | 100Vdc        | 10000M ohm                   | -55°C to +125°C             |
| NFM41CC221U2A3□ | 220pF +50/-20%   | 300mA         | 100Vdc        | 10000M ohm                   | -55°C to +125°C             |
| NFM41CC471R2A3□ | 470pF +50/-20%   | 300mA         | 100Vdc        | 10000M ohm                   | -55°C to +125°C             |
| NFM41CC102R2A3□ | 1000pF +50/-20%  | 300mA         | 100Vdc        | 10000M ohm                   | -55°C to +125°C             |
| NFM41CC222R2A3□ | 2200pF +50/-20%  | 300mA         | 100Vdc        | 10000M ohm                   | -55°C to +125°C             |
| NFM41CC223R2A3□ | 22000pF +50/-20% | 300mA         | 100Vdc        | 10000M ohm                   | -55°C to +125°C             |

Number of Circuit: 1

### ■ Insertion Loss Characteristics

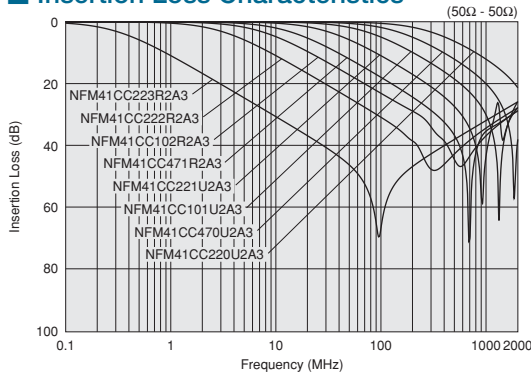

△Note • Please read rating and △CAUTION (for storage, operating, rating, soldering, mounting and handling) in this catalog to prevent smoking and/or burning, etc.  
 • This catalog has only typical specifications. Therefore, please approve our product specifications or transact the approval sheet for product specifications before ordering.

Chip Ferrite Bead  
 Chip EMIFIL® Signal Lines Type  
 Chip Common Mode Choke Coil  
 Block Type EMIFIL®  
 Microwave Absorber

# NFA31CC Series 1206/3216 (inch/mm)



4-line chip 3-terminal capacitor array, 1206 size.

### ■ Dimensions

(in mm)

### ■ Equivalent Circuit

Output (Input)  
No polarity.

### ■ Packaging

| Code | Packaging             | Minimum Quantity |
|------|-----------------------|------------------|
| D    | 180mm Reel Paper Tape | 4000             |
| B    | Bulk(Bag)             | 100              |

Refer to pages from p.156 to p.162 for mounting information.

### ■ Rated Value (□: packaging code)

| Part Number     | Capacitance  | Rated Current | Rated Voltage | Insulation Resistance (min.) | Operating Temperature Range |     |
|-----------------|--------------|---------------|---------------|------------------------------|-----------------------------|-----|
| NFA31CC220S1E4□ | 22pF ±20%    | 200mA         | 25Vdc         | 1000M ohm                    | -40°C to +85°C              | Kit |
| NFA31CC470S1E4□ | 47pF ±20%    | 200mA         | 25Vdc         | 1000M ohm                    | -40°C to +85°C              | Kit |
| NFA31CC101S1E4□ | 100pF ±20%   | 200mA         | 25Vdc         | 1000M ohm                    | -40°C to +85°C              | Kit |
| NFA31CC221S1E4□ | 220pF ±20%   | 200mA         | 25Vdc         | 1000M ohm                    | -40°C to +85°C              | Kit |
| NFA31CC471R1E4□ | 470pF ±20%   | 200mA         | 25Vdc         | 1000M ohm                    | -40°C to +85°C              | Kit |
| NFA31CC102R1E4□ | 1000pF ±20%  | 200mA         | 25Vdc         | 1000M ohm                    | -40°C to +85°C              | Kit |
| NFA31CC222R1E4□ | 2200pF ±20%  | 200mA         | 25Vdc         | 1000M ohm                    | -40°C to +85°C              | Kit |
| NFA31CC223R1C4□ | 22000pF ±20% | 200mA         | 16Vdc         | 1000M ohm                    | -40°C to +85°C              | Kit |

Number of Circuit: 4

### ■ Insertion Loss Characteristics

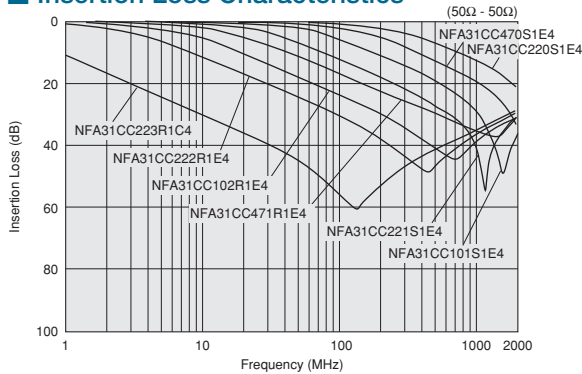

△Note • Please read rating and △CAUTION (for storage, operating, rating, soldering, mounting and handling) in this catalog to prevent smoking and/or burning, etc.  
• This catalog has only typical specifications. Therefore, please approve our product specifications or transact the approval sheet for product specifications before ordering.

# NFL15ST Series 0402/1005 (inch/mm)



## T-type LC filter, ultra-compact size of 0402.



### ■ Dimensions

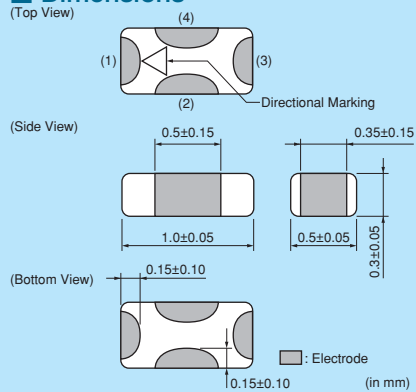

### ■ Equivalent Circuit

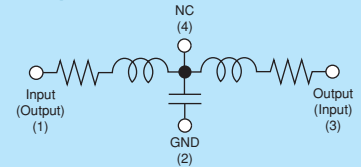

### ■ Packaging

| Code | Packaging             | Minimum Quantity |
|------|-----------------------|------------------|
| D    | 180mm Reel Paper Tape | 10000            |
| B    | Bulk(Bag)             | 500              |

Refer to pages from p.156 to p.162 for mounting information.

### ■ Rated Value (□: packaging code)

| Part Number     | Nominal Cut-off Frequency | Capacitance | Inductance   | Insertion Loss 1      | Insertion Loss 2          | Rated Current | Rated Voltage |     |
|-----------------|---------------------------|-------------|--------------|-----------------------|---------------------------|---------------|---------------|-----|
| NFL15ST157X0J3□ | 150MHz                    | 22pF (Typ.) | 115nH (Typ.) | 6dB max.(0 to 150MHz) | 25dB min.(400 to 1000MHz) | 50mA          | 6.3Vdc        | Kit |
| NFL15ST207X0J3□ | 200MHz                    | 17pF (Typ.) | 105nH (Typ.) | 6dB max.(0 to 200MHz) | 25dB min.(600 to 1000MHz) | 50mA          | 6.3Vdc        | Kit |
| NFL15ST307X0J3□ | 300MHz                    | 12pF (Typ.) | 95nH (Typ.)  | 6dB max.(0 to 300MHz) | 25dB min.(800 to 1000MHz) | 50mA          | 6.3Vdc        | Kit |
| NFL15ST507X0J3□ | 500MHz                    | 7pF (Typ.)  | 60nH (Typ.)  | 6dB max.(0 to 500MHz) | 25dB min.(1000MHz)        | 50mA          | 6.3Vdc        | Kit |

Insulation Resistance (min.): 1000M ohm    Withstand Voltage: 18.9Vdc    Operating Temperature Range: -40°C to +85°C    Number of Circuits: 1

### ■ Insertion Loss Characteristics

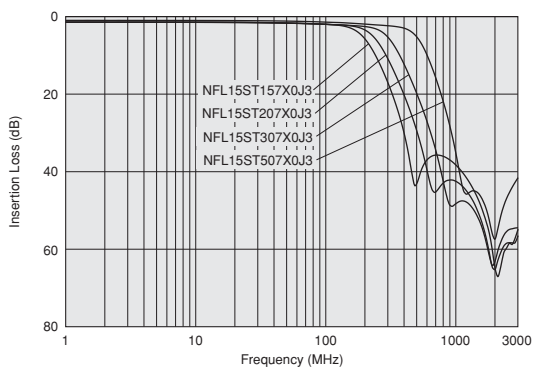

⚠Note • Please read rating and ⚠CAUTION (for storage, operating, rating, soldering, mounting and handling) in this catalog to prevent smoking and/or burning, etc.  
• This catalog has only typical specifications. Therefore, please approve our product specifications or transact the approval sheet for product specifications before ordering.

# NFL18ST Series 0603/1608 (inch/mm)



T-type LC filter. Reduces waveform distortion of high speed signal.

**NFL18ST\_H**

### ■ Dimensions

(Top View)

(Side View)

(Bottom View)

Legend:  Electrode (in mm)

\*1 There are no electrical polarity. But there is a directional marking on the top of product to identify inner physical direction.

### ■ Equivalent Circuit

Input (Output) (1) Output (Input) (3)  
GND (2)  
No Polarity.

### ■ Packaging

| Code | Packaging             | Minimum Quantity |
|------|-----------------------|------------------|
| D    | 180mm Reel Paper Tape | 4000             |
| B    | Bulk(Bag)             | 1000             |

**NFL18ST\_X**

### ■ Dimensions

Legend:  Electrode (in mm)

### ■ Equivalent Circuit

Input (Output) (1) Output (Input) (3)  
GND (2)  
No Polarity.

### ■ Packaging

| Code | Packaging             | Minimum Quantity |
|------|-----------------------|------------------|
| D    | 180mm Reel Paper Tape | 4000             |
| B    | Bulk(Bag)             | 1000             |

Refer to pages from p.156 to p.162 for mounting information.

## ■ Rated Value (□: packaging code)

| Part Number     | Nominal Cut-off Frequency | Capacitance  | Inductance   | Insertion Loss 1      | Insertion Loss 2           | Rated Current | Rated Voltage | Kit | DTV |
|-----------------|---------------------------|--------------|--------------|-----------------------|----------------------------|---------------|---------------|-----|-----|
| NFL18ST506H1A3□ | 50MHz                     | 110pF (Typ.) | 350nH (Typ.) | 6dB max.(0 to 50MHz)  | 30dB min.(200 to 1000MHz)  | 75mA          | 10Vdc         | Kit | DTV |
| NFL18ST706H1A3□ | 70MHz                     | 70pF (Typ.)  | 230nH (Typ.) | 6dB max.(0 to 70MHz)  | 30dB min.(300 to 1000MHz)  | 75mA          | 10Vdc         | Kit | DTV |
| NFL18ST107H1A3□ | 100MHz                    | 50pF (Typ.)  | 150nH (Typ.) | 6dB max.(0 to 100MHz) | 30dB min.(400 to 1000MHz)  | 75mA          | 10Vdc         | Kit | DTV |
| NFL18ST207H1A3□ | 200MHz                    | 22pF (Typ.)  | 110nH (Typ.) | 6dB max.(0 to 200MHz) | 30dB min.(800 to 2000MHz)  | 100mA         | 10Vdc         | Kit | DTV |
| NFL18ST307H1A3□ | 300MHz                    | 16pF (Typ.)  | 74nH (Typ.)  | 6dB max.(0 to 300MHz) | 30dB min.(1200 to 2000MHz) | 100mA         | 10Vdc         | Kit |     |
| NFL18ST507H1A3□ | 500MHz                    | 10pF (Typ.)  | 42nH (Typ.)  | 6dB max.(0 to 500MHz) | 30dB min.(1700 to 2000MHz) | 100mA         | 10Vdc         | Kit |     |

Insulation Resistance (min.): 1000M ohm    Withstand Voltage: 30Vdc    Operating Temperature Range: -55°C to +125°C    Number of Circuits: 1

## ■ Insertion Loss Characteristics

### NFL18ST\_H Series

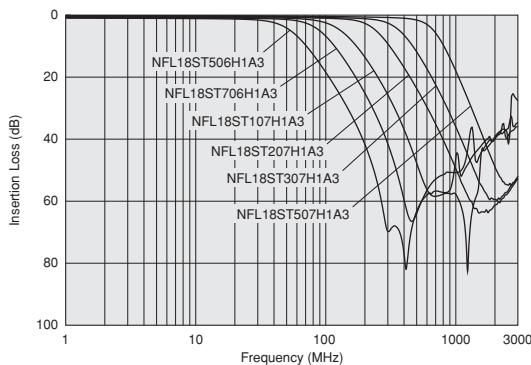

Continued on the following page.

⚠Note • Please read rating and ⚠CAUTION (for storage, operating, rating, soldering, mounting and handling) in this catalog to prevent smoking and/or burning, etc.  
• This catalog has only typical specifications. Therefore, please approve our product specifications or transact the approval sheet for product specifications before ordering.

■ Rated Value (□: packaging code)

| Part Number     | Nominal Cut-off Frequency | Capacitance | Inductance | Rated Current | Rated Voltage | Insulation Resistance (min.) | Withstand Voltage | Operating Temperature Range |     |
|-----------------|---------------------------|-------------|------------|---------------|---------------|------------------------------|-------------------|-----------------------------|-----|
| NFL18ST207X1C3□ | 200MHz                    | 25pF±20%    | 110nH±20%  | 150mA         | 16Vdc         | 1000M ohm                    | 50Vdc             | -55°C to +125°C             | Kit |
| NFL18ST307X1C3□ | 300MHz                    | 18pF±20%    | 62nH±20%   | 200mA         | 16Vdc         | 1000M ohm                    | 50Vdc             | -55°C to +125°C             | Kit |
| NFL18ST507X1C3□ | 500MHz                    | 10pF±20%    | 43nH±20%   | 200mA         | 16Vdc         | 1000M ohm                    | 50Vdc             | -55°C to +125°C             | Kit |

Number of Circuits: 1

■ Insertion Loss Characteristics

NFL18ST\_X Series

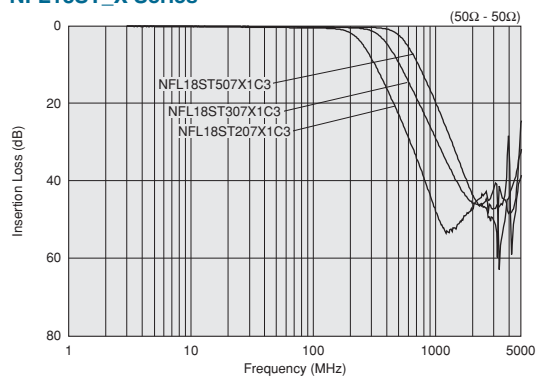

△Note • Please read rating and △CAUTION (for storage, operating, rating, soldering, mounting and handling) in this catalog to prevent smoking and/or burning, etc.  
• This catalog has only typical specifications. Therefore, please approve our product specifications or transact the approval sheet for product specifications before ordering.



# NFL18SP Series 0603/1608 (inch/mm)



PI-type LC filter. Reduces waveform distortion of high speed signal.

### ■ Dimensions

0.15±0.1  
0.8±0.1  
1.6±0.1  
0.2 min.  
0.3±0.1 0.4±0.1 0.3±0.1 0.15±0.1 0.15±0.1 0.6±0.1

Legend:  Electrode (in mm)

### ■ Equivalent Circuit

Input (Output) (1) Output (Input) (3)  
GND (2)  
No polarity.

### ■ Packaging

| Code | Packaging             | Minimum Quantity |
|------|-----------------------|------------------|
| D    | 180mm Reel Paper Tape | 4000             |
| B    | Bulk(Bag)             | 1000             |

Refer to pages from p.156 to p.162 for mounting information.

### ■ Rated Value (□: packaging code)

| Part Number     | Nominal Cut-off Frequency | Capacitance | Inductance | Rated Current | Rated Voltage | Insulation Resistance (min.) | Withstand Voltage | Operating Temperature Range |     |
|-----------------|---------------------------|-------------|------------|---------------|---------------|------------------------------|-------------------|-----------------------------|-----|
| NFL18SP157X1A3□ | 150MHz                    | 34pF±20%    | 100nH±20%  | 100mA         | 10Vdc         | 1000M ohm                    | 30Vdc             | -55°C to +125°C             | Kit |
| NFL18SP207X1A3□ | 200MHz                    | 24pF±20%    | 80nH±20%   | 100mA         | 10Vdc         | 1000M ohm                    | 30Vdc             | -55°C to +125°C             | Kit |
| NFL18SP307X1A3□ | 300MHz                    | 19pF±20%    | 60nH±20%   | 100mA         | 10Vdc         | 1000M ohm                    | 30Vdc             | -55°C to +125°C             | Kit |
| NFL18SP507X1A3□ | 500MHz                    | 11pF±20%    | 38nH±20%   | 100mA         | 10Vdc         | 1000M ohm                    | 30Vdc             | -55°C to +125°C             | Kit |

Number of Circuits: 1

### ■ Insertion Loss Characteristics

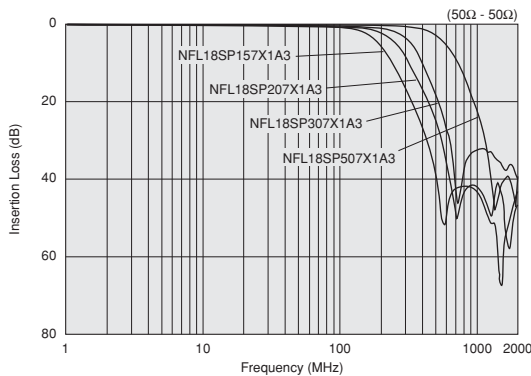

△Note • Please read rating and △CAUTION (for storage, operating, rating, soldering, mounting and handling) in this catalog to prevent smoking and/or burning, etc.  
• This catalog has only typical specifications. Therefore, please approve our product specifications or transact the approval sheet for product specifications before ordering.

# NFL21SP Series 0805/2012 (inch/mm)



PI-type LC filter. Reduces waveform distortion of high speed signal.

Chip Ferrite Bead

Chip EMIFIL®  
Signal Lines Type

Chip Common Mode Choke Coil

Block Type EMIFIL®

Microwave Absorber

### ■ Dimensions

0.3±0.2    0.4±0.2  
0.85±0.1  
0.6±0.2  
2.0±0.2  
0.25±0.2  
1.25±0.1

Legend:  Electrode (in mm)

### ■ Equivalent Circuit

Input (Output) (1)    Output (Input) (3)  
GND (2)  
No polarity.

### ■ Packaging

| Code | Packaging             | Minimum Quantity |
|------|-----------------------|------------------|
| D    | 180mm Reel Paper Tape | 4000             |
| B    | Bulk(Bag)             | 1000             |

Refer to pages from p.156 to p.162 for mounting information.

## ■ Rated Value (□: packaging code)

| Part Number     | Nominal Cut-off Frequency | Capacitance | Inductance | Rated Current | Rated Voltage | Insulation Resistance (min.) | Withstand Voltage | Operating Temperature Range |     |
|-----------------|---------------------------|-------------|------------|---------------|---------------|------------------------------|-------------------|-----------------------------|-----|
| NFL21SP106X1C3□ | 10MHz                     | 670pF±20%   | 680nH±20%  | 100mA         | 16Vdc         | 1000M ohm                    | 50Vdc             | -55°C to +125°C             | Kit |
| NFL21SP206X1C7□ | 20MHz                     | 240pF±20%   | 700nH±20%  | 100mA         | 16Vdc         | 1000M ohm                    | 50Vdc             | -55°C to +125°C             | Kit |
| NFL21SP506X1C3□ | 50MHz                     | 84pF±20%    | 305nH±20%  | 150mA         | 16Vdc         | 1000M ohm                    | 50Vdc             | -55°C to +125°C             | Kit |
| NFL21SP706X1C3□ | 70MHz                     | 76pF±20%    | 185nH±20%  | 150mA         | 16Vdc         | 1000M ohm                    | 50Vdc             | -55°C to +125°C             | Kit |
| NFL21SP107X1C3□ | 100MHz                    | 44pF±20%    | 135nH±20%  | 200mA         | 16Vdc         | 1000M ohm                    | 50Vdc             | -55°C to +125°C             | Kit |
| NFL21SP157X1C3□ | 150MHz                    | 28pF±20%    | 128nH±20%  | 200mA         | 16Vdc         | 1000M ohm                    | 50Vdc             | -55°C to +125°C             | Kit |
| NFL21SP207X1C3□ | 200MHz                    | 22pF±20%    | 72nH±20%   | 250mA         | 16Vdc         | 1000M ohm                    | 50Vdc             | -55°C to +125°C             | Kit |
| NFL21SP307X1C3□ | 300MHz                    | 19pF±10%    | 45nH±10%   | 300mA         | 16Vdc         | 1000M ohm                    | 50Vdc             | -55°C to +125°C             | Kit |
| NFL21SP407X1C3□ | 400MHz                    | 16pF±10%    | 34nH±10%   | 300mA         | 16Vdc         | 1000M ohm                    | 50Vdc             | -55°C to +125°C             | Kit |
| NFL21SP507X1C3□ | 500MHz                    | 12pF±10%    | 31nH±10%   | 300mA         | 16Vdc         | 1000M ohm                    | 50Vdc             | -55°C to +125°C             | Kit |

Number of Circuits: 1

## ■ Insertion Loss Characteristics

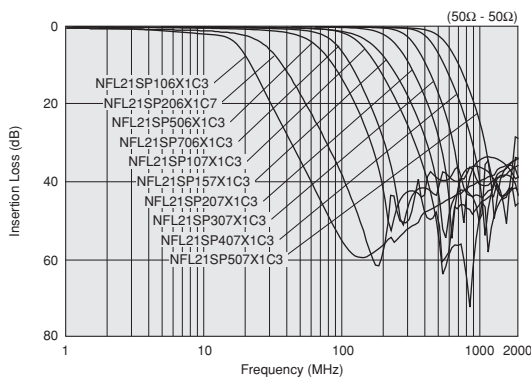

△Note • Please read rating and △CAUTION (for storage, operating, rating, soldering, mounting and handling) in this catalog to prevent smoking and/or burning, etc.  
• This catalog has only typical specifications. Therefore, please approve our product specifications or transact the approval sheet for product specifications before ordering.

# NFA18SL Series 0603/1608 (inch/mm)



## LC filter 4-line array for mobile phones.

NFA18SL 137/187/207/357 V1A45  
NFA18SL506X1A45



### ■ Dimensions

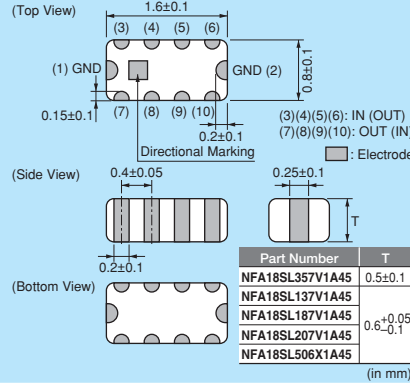

### ■ Equivalent Circuit

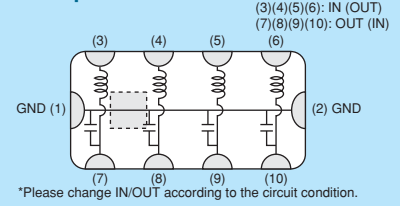

### ■ Packaging

| Code | Packaging                | Minimum Quantity |
|------|--------------------------|------------------|
| L    | 180mm Reel Embossed Tape | 4000             |
| B    | Bulk(Bag)                | 1000             |

NFA18SL227V1A45



### ■ Dimensions

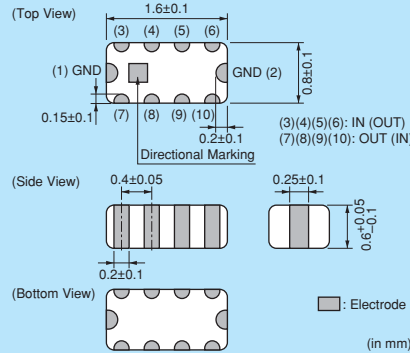

### ■ Equivalent Circuit

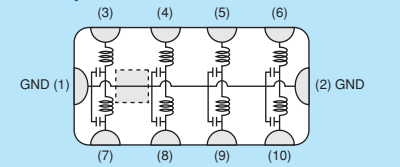

### ■ Packaging

| Code | Packaging                | Minimum Quantity |
|------|--------------------------|------------------|
| L    | 180mm Reel Embossed Tape | 4000             |
| B    | Bulk(Bag)                | 1000             |

NFA18SL 307/407/487 V1A45



### ■ Dimensions

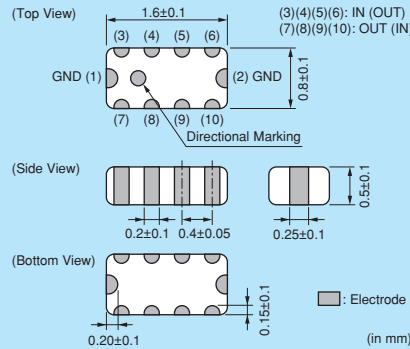

### ■ Equivalent Circuit

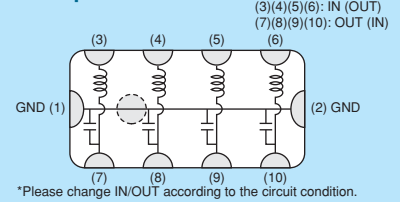

### ■ Packaging

| Code | Packaging                | Minimum Quantity |
|------|--------------------------|------------------|
| L    | 180mm Reel Embossed Tape | 4000             |
| B    | Bulk(Bag)                | 1000             |

Refer to pages from p.156 to p.162 for mounting information.

### ■ Rated Value (□: packaging code)

| Part Number      | Nominal Cut-off Frequency | Insertion Loss (Cut-off Frequency) | Insertion Loss (470MHz) (min.) | Insertion Loss (800MHz) (min.) | Insertion Loss (900MHz) (min.) | Insertion Loss (2000MHz) (min.) | Rated Current | Rated Voltage | Insulation Resistance (min.) | Withstand Voltage | Kit | OTV |
|------------------|---------------------------|------------------------------------|--------------------------------|--------------------------------|--------------------------------|---------------------------------|---------------|---------------|------------------------------|-------------------|-----|-----|
| NFA18SL137V1A45□ | 130MHz                    | 6dB max.                           | 25dB                           | -                              | 25dB                           | -                               | 50mA          | 10Vdc         | 1000M ohm                    | 30Vdc             | Kit | OTV |
| NFA18SL187V1A45□ | 180MHz                    | 6dB max.                           | 20dB                           | -                              | 20dB                           | -                               | 50mA          | 10Vdc         | 1000M ohm                    | 30Vdc             | Kit | OTV |
| NFA18SL207V1A45□ | 200MHz                    | 6dB max.                           | 15dB                           | -                              | 15dB                           | -                               | 50mA          | 10Vdc         | 1000M ohm                    | 30Vdc             | Kit | OTV |
| NFA18SL227V1A45□ | 220MHz                    | 6dB max.                           | -                              | -                              | 30dB                           | 30dB                            | 25mA          | 10Vdc         | 1000M ohm                    | 30Vdc             | Kit | OTV |
| NFA18SL307V1A45□ | 300MHz                    | 6dB max.                           | -                              | 20dB                           | 20dB                           | -                               | 100mA         | 10Vdc         | 1000M ohm                    | 30Vdc             | Kit |     |
| NFA18SL357V1A45□ | 350MHz                    | 6dB max.                           | -                              | -                              | 15dB                           | 13dB                            | 35mA          | 10Vdc         | 1000M ohm                    | 30Vdc             | Kit |     |
| NFA18SL407V1A45□ | 400MHz                    | 6dB max.                           | -                              | 18dB                           | 18dB                           | -                               | 100mA         | 10Vdc         | 1000M ohm                    | 30Vdc             | Kit |     |
| NFA18SL487V1A45□ | 480MHz                    | 6dB max.                           | -                              | 15dB                           | 15dB                           | -                               | 100mA         | 10Vdc         | 1000M ohm                    | 30Vdc             | Kit |     |

Operating Temperature Range: -40°C to +85°C (NFA18SL 137/187/207/227/357 V1A45), -55°C to +125°C (NFA18SL 307/407/487 V1A45) Number of Circuits: 4 Continued on the following page.

△Note • Please read rating and △CAUTION (for storage, operating, rating, soldering, mounting and handling) in this catalog to prevent smoking and/or burning, etc.  
• This catalog has only typical specifications. Therefore, please approve our product specifications or transact the approval sheet for product specifications before ordering.

■ Insertion Loss Characteristics

NFA18SL 137/187/207 V1A45

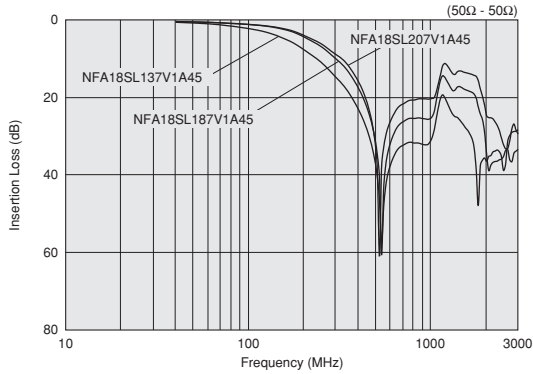

NFA18SL227V1A45

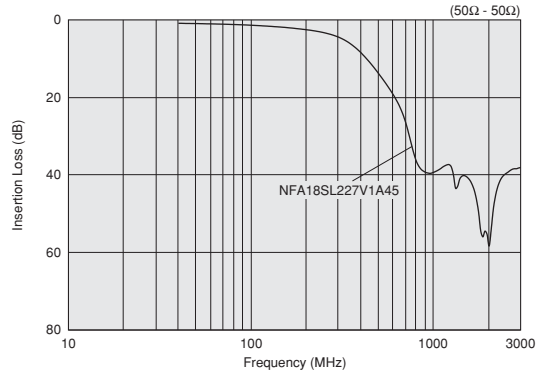

NFA18SL 307/407/487 V1A45

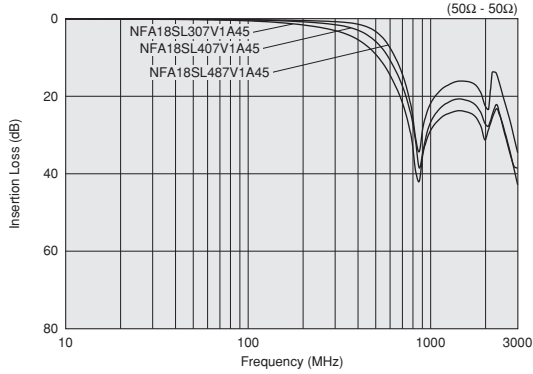

NFA18SL357V1A45

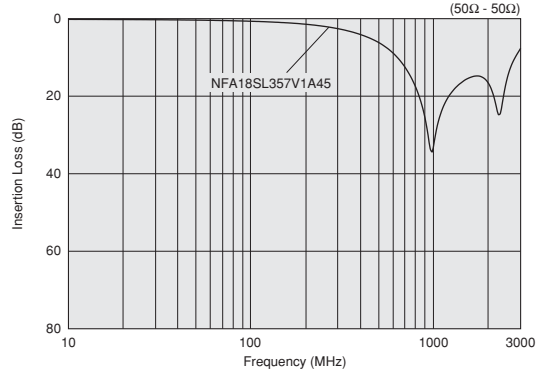

■ Rated Value (□: packaging code)

| Part Number      | Nominal Cut-off Frequency | Insertion Loss (Cut-off Frequency) | Insertion Loss (500MHz) (min.) | Insertion Loss (1000MHz) (min.) | Rated Current | Rated Voltage | Insulation Resistance (min.) | Withstand Voltage |     |
|------------------|---------------------------|------------------------------------|--------------------------------|---------------------------------|---------------|---------------|------------------------------|-------------------|-----|
| NFA18SL506X1A45□ | 50MHz                     | 6dB max.                           | 30dB                           | 25dB                            | 25mA          | 10Vdc         | 1000M ohm                    | 30Vdc             | Kit |

Operating Temperature Range: -40°C to +85°C Number of Circuits: 4

■ Insertion Loss Characteristics

NFA18SL\_X

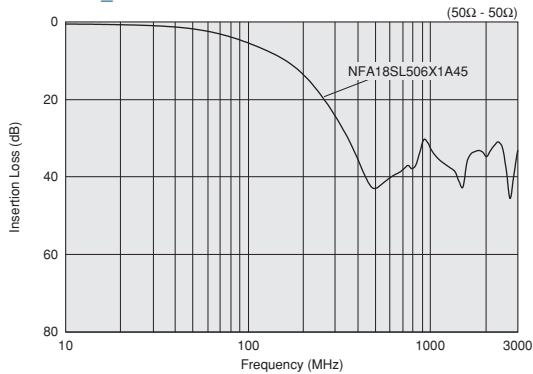

⚠Note • Please read rating and ⚠CAUTION (for storage, operating, rating, soldering, mounting and handling) in this catalog to prevent smoking and/or burning, etc.  
• This catalog has only typical specifications. Therefore, please approve our product specifications or transact the approval sheet for product specifications before ordering.

Chip Ferrite Bead

Chip EMIFIL®  
Signal Lines Type

Chip Common Mode Choke Coil

Block Type EMIFIL®

Microwave Absorber

# NFA18SD Series 0603/1608 (inch/mm)



For differential signal I/F of LCD or camera in mobile phones.

### ■ Dimensions

(Top View) 1.6±0.1  
 (3) (4) (5) (6)  
 (1) GND (2) GND  
 0.15±0.1  
 0.2±0.1  
 Directional Marking  
 (3)(4)(5)(6): IN (OUT)  
 (7)(8)(9)(10): OUT (IN)

(Side View) 0.4±0.05  
 0.25±0.1  
 0.6±0.06

(Bottom View) 0.2±0.1

■ Electrode  
 (in mm)

### ■ Equivalent Circuit

(3) (4) (5) (6)  
 GND (1) (2) GND  
 (7) (8) (9) (10)

### ■ Packaging

| Code | Packaging                | Minimum Quantity |
|------|--------------------------|------------------|
| L    | 180mm Reel Embossed Tape | 4000             |
| B    | Bulk(Bag)                | 1000             |

Refer to pages from p.156 to p.162 for mounting information.

### ■ Rated Value (□: packaging code)

| Part Number      | Nominal Cut-off Frequency | Insertion Loss (Cut-off Frequency) | Insertion Loss (500MHz) (min.) | Insertion Loss (900MHz) (min.) | Insertion Loss (1500MHz) (min.) | Insertion Loss (2000MHz) (min.) | Rated Current | Rated Voltage | Insulation Resistance (min.) | Withstand Voltage | Kit | OTV |
|------------------|---------------------------|------------------------------------|--------------------------------|--------------------------------|---------------------------------|---------------------------------|---------------|---------------|------------------------------|-------------------|-----|-----|
| NFA18SD187X1A45□ | 180MHz                    | 6dB max.                           | 15dB                           | 20dB                           | 20dB                            | 20dB                            | 25mA          | 10Vdc         | 1000M ohm                    | 30Vdc             | Kit | OTV |
| NFA18SD207X1A45□ | 200MHz                    | 6dB max.                           | 13dB                           | 20dB                           | 20dB                            | 20dB                            | 25mA          | 10Vdc         | 1000M ohm                    | 30Vdc             | Kit | OTV |

Operating Temperature Range: -40°C to +85°C Number of Circuits: 4

### ■ Insertion Loss Characteristics

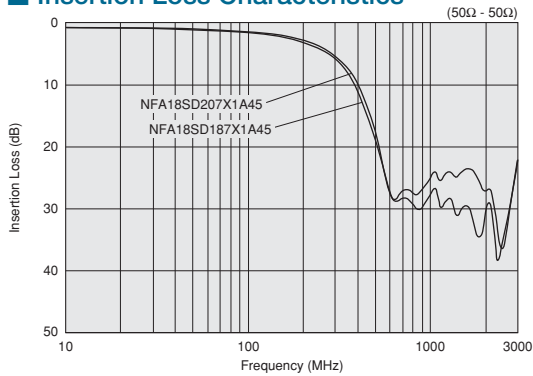

△Note • Please read rating and △CAUTION (for storage, operating, rating, soldering, mounting and handling) in this catalog to prevent smoking and/or burning, etc.  
 • This catalog has only typical specifications. Therefore, please approve our product specifications or transact the approval sheet for product specifications before ordering.

# NFA21SL Series 0805/2012 (inch/mm)



L-type LC filter 4-line array for mobile phones.



### Dimensions

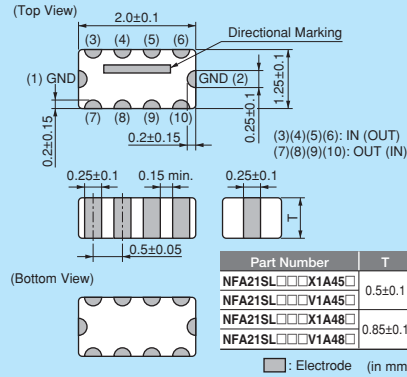

### Equivalent Circuit

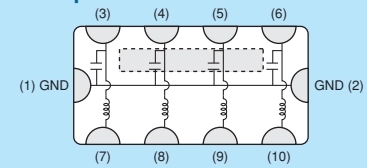

### Packaging

| Code | Packaging                | Minimum Quantity |
|------|--------------------------|------------------|
| L    | 180mm Reel Embossed Tape | 4000             |
| B    | Bulk(Bag)                | 1000             |

Refer to pages from p.156 to p.162 for mounting information.

### Rated Value (□: packaging code)

| Part Number      | Nominal Cut-off Frequency | Insertion Loss (Cut-off Frequency) | Insertion Loss (800MHz) (min.) | Insertion Loss (900MHz) (min.) | Rated Current | Rated Voltage | Insulation Resistance (min.) | Withstand Voltage |     |
|------------------|---------------------------|------------------------------------|--------------------------------|--------------------------------|---------------|---------------|------------------------------|-------------------|-----|
| NFA21SL287V1A45□ | 280MHz                    | 6dB max.                           | 25dB                           | 25dB                           | 100mA         | 10Vdc         | 1000M ohm                    | 30Vdc             | Kit |
| NFA21SL317V1A45□ | 310MHz                    | 6dB max.                           | 20dB                           | 20dB                           | 100mA         | 10Vdc         | 1000M ohm                    | 30Vdc             | Kit |
| NFA21SL337V1A45□ | 330MHz                    | 6dB max.                           | 15dB                           | 15dB                           | 100mA         | 10Vdc         | 1000M ohm                    | 30Vdc             | Kit |
| NFA21SL287V1A48□ | 280MHz                    | 6dB max.                           | 25dB                           | 25dB                           | 100mA         | 10Vdc         | 1000M ohm                    | 30Vdc             | Kit |
| NFA21SL317V1A48□ | 310MHz                    | 6dB max.                           | 20dB                           | 20dB                           | 100mA         | 10Vdc         | 1000M ohm                    | 30Vdc             | Kit |
| NFA21SL337V1A48□ | 330MHz                    | 6dB max.                           | 20dB                           | 20dB                           | 100mA         | 10Vdc         | 1000M ohm                    | 30Vdc             | Kit |

Operating Temperature Range: -55°C to +125°C Number of Circuits: 4

### Insertion Loss Characteristics

NFA21SL\_V1A45

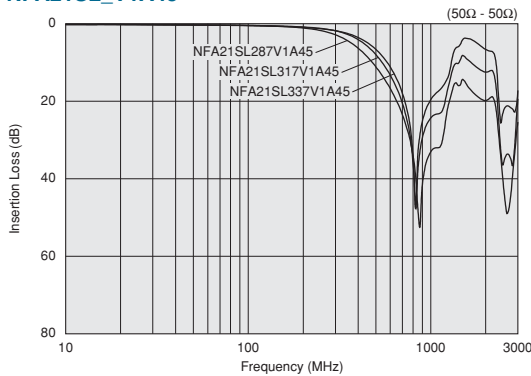

NFA21SL\_V1A48

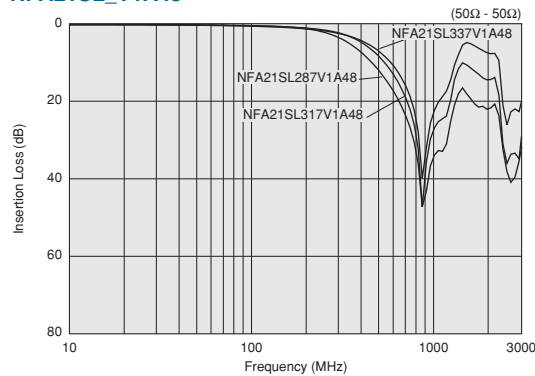

Continued on the following page. ↗

△Note • Please read rating and △CAUTION (for storage, operating, rating, soldering, mounting and handling) in this catalog to prevent smoking and/or burning, etc.  
• This catalog has only typical specifications. Therefore, please approve our product specifications or transact the approval sheet for product specifications before ordering.

Chip Ferrite Bead

Chip EMIFIL®  
Signal Lines Type

Chip Common Mode Choke Coil

Block Type EMIFIL®

Microwave Absorber

■ Rated Value (□: packaging code)

| Part Number      | Nominal Cut-off Frequency | Insertion Loss (Cut-off Frequency) | Insertion Loss (500MHz) (min.) | Insertion Loss (800MHz) (min.) | Insertion Loss (1000MHz) (min.) | Rated Current | Rated Voltage | Insulation Resistance (min.) | Withstand Voltage |     |
|------------------|---------------------------|------------------------------------|--------------------------------|--------------------------------|---------------------------------|---------------|---------------|------------------------------|-------------------|-----|
| NFA21SL207X1A45□ | 200MHz                    | 2dB to 7dB                         | 13dB                           | 25dB                           | 25dB                            | 100mA         | 10Vdc         | 1000M ohm                    | 30Vdc             | Kit |
| NFA21SL307X1A45□ | 300MHz                    | 2dB to 7dB                         | 7dB                            | 20dB                           | 25dB                            | 100mA         | 10Vdc         | 1000M ohm                    | 30Vdc             | Kit |
| NFA21SL506X1A48□ | 50MHz                     | 0dB to 6dB                         | 30dB                           | -                              | 20dB                            | 20mA          | 10Vdc         | 1000M ohm                    | 30Vdc             | Kit |
| NFA21SL806X1A48□ | 80MHz                     | 2dB to 7dB                         | 25dB                           | -                              | 25dB                            | 20mA          | 10Vdc         | 1000M ohm                    | 30Vdc             | Kit |
| NFA21SL207X1A48□ | 200MHz                    | 2dB to 7dB                         | 13dB                           | 25dB                           | 25dB                            | 100mA         | 10Vdc         | 1000M ohm                    | 30Vdc             | Kit |
| NFA21SL307X1A48□ | 300MHz                    | 2dB to 7dB                         | 7dB                            | 20dB                           | 25dB                            | 100mA         | 10Vdc         | 1000M ohm                    | 30Vdc             | Kit |

Operating Temperature Range: -55°C to +125°C Number of Circuits: 4

■ Insertion Loss Characteristics

NFA21SL\_X

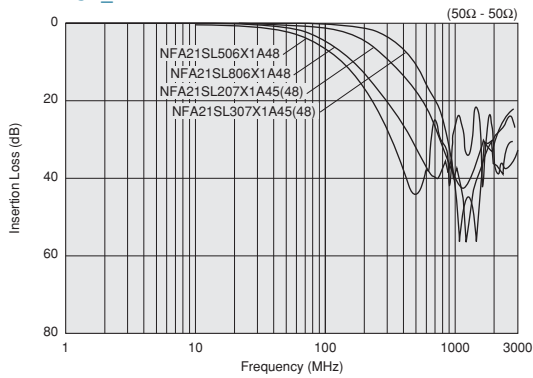

Chip Ferrite Bead

Signal Lines Type  
 Chip EMIFIL®

Chip Common Mode Choke Coil

Block Type EMIFIL®

Microwave Absorber

⚠Note • Please read rating and ⚠CAUTION (for storage, operating, rating, soldering, mounting and handling) in this catalog to prevent smoking and/or burning, etc.  
 • This catalog has only typical specifications. Therefore, please approve our product specifications or transact the approval sheet for product specifications before ordering.

# NFW31SP Series 1206/3216 (inch/mm)



## Wire-wound PI-type LC filter.



### ■ Dimensions

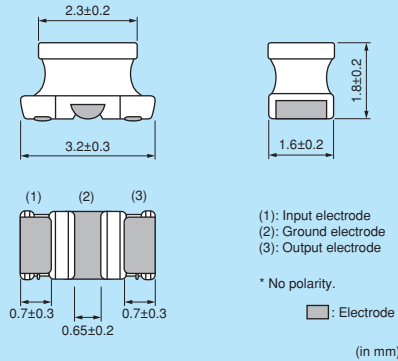

### ■ Equivalent Circuit

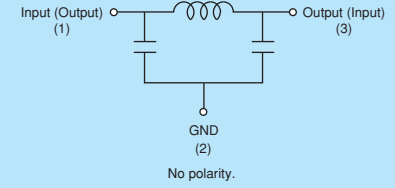

### ■ Packaging

| Code | Packaging                | Minimum Quantity |
|------|--------------------------|------------------|
| L    | 180mm Reel Embossed Tape | 2000             |
| K    | 330mm Reel Embossed Tape | 7500             |

Refer to pages from p.156 to p.162 for mounting information.

### ■ Rated Value (□: packaging code)

| Part Number     | Nominal Cut-off Frequency | Insertion Loss at 10MHz | Insertion Loss at 20MHz | Insertion Loss at 50MHz | Insertion Loss at 100MHz | Insertion Loss at 150MHz | Insertion Loss at 200MHz | Insertion Loss at 300MHz | Insertion Loss at 400MHz | Insertion Loss at 500MHz | Insertion Loss at 1000MHz | Kit |
|-----------------|---------------------------|-------------------------|-------------------------|-------------------------|--------------------------|--------------------------|--------------------------|--------------------------|--------------------------|--------------------------|---------------------------|-----|
| NFW31SP106X1E4□ | 10MHz                     | 6dB max.                | 5dB min.                | 25dB min.               | 25dB min.                | -                        | 25dB min.                | -                        | -                        | 30dB min.                | 30dB min.                 | Kit |
| NFW31SP206X1E4□ | 20MHz                     | -                       | 6dB max.                | 5dB min.                | 25dB min.                | -                        | 25dB min.                | -                        | -                        | 30dB min.                | 30dB min.                 | Kit |
| NFW31SP506X1E4□ | 50MHz                     | -                       | -                       | 6dB max.                | 10dB min.                | -                        | 30dB min.                | -                        | -                        | 30dB min.                | 30dB min.                 | Kit |
| NFW31SP107X1E4□ | 100MHz                    | -                       | -                       | -                       | 6dB max.                 | -                        | 5dB min.                 | -                        | -                        | 20dB min.                | 30dB min.                 | Kit |
| NFW31SP157X1E4□ | 150MHz                    | -                       | -                       | -                       | -                        | 6dB max.                 | -                        | 10dB min.                | 20dB min.                | 30dB min.                | 30dB min.                 | Kit |
| NFW31SP207X1E4□ | 200MHz                    | -                       | -                       | -                       | -                        | -                        | 6dB max.                 | -                        | -                        | 10dB min.                | 30dB min.                 | Kit |
| NFW31SP307X1E4□ | 300MHz                    | -                       | -                       | -                       | -                        | -                        | -                        | 6dB max.                 | -                        | 5dB min.                 | 15dB min.                 | Kit |
| NFW31SP407X1E4□ | 400MHz                    | -                       | -                       | -                       | -                        | -                        | -                        | -                        | 6dB max.                 | -                        | 10dB min.                 | Kit |
| NFW31SP507X1E4□ | 500MHz                    | -                       | -                       | -                       | -                        | -                        | -                        | -                        | -                        | 6dB max.                 | 10dB min.                 | Kit |

Rated Current: 200mA    Rated Voltage: 25Vdc    Operating Temperature Range: -40°C to +85°C    Number of Circuit: 1

### ■ Insertion Loss Characteristics

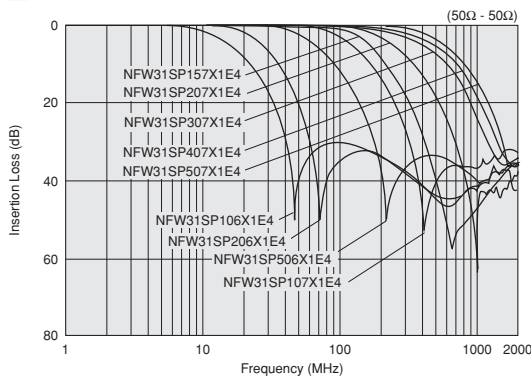

△Note • Please read rating and △CAUTION (for storage, operating, rating, soldering, mounting and handling) in this catalog to prevent smoking and/or burning, etc.  
• This catalog has only typical specifications. Therefore, please approve our product specifications or transact the approval sheet for product specifications before ordering.

Chip Ferrite Bead

Chip EMIFIL®  
Signal Lines Type

Chip Common Mode Choke Coil

Block Type EMIFIL®

Microwave Absorber



## Example of EMI Suppression in an Actual Circuit

Measuring Circuit

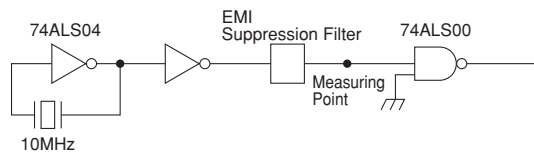

| Type of Filter  | Signal Wave Form (20ns/div / 1V/div) / EMI Suppression Effect / Description  |
|---|--|
| Signal Waveform and Noise Spectrum before Filter Mounting | <p>Signal Waveform (20ns/div / 1V/div)</p> <p>Noise Spectrum (10:1 Active Probe)</p>   |
| NFW31SP Series (Cut-off frequency 50MHz)                  | <p>NFW31SP's steep attenuation characteristic means excellent EMI suppression without waveform cornering.</p>  |
| Conventional Chip Solid Type EMI Filter (NFM41CC 470pF)   | <p>3-terminal capacitors suppress signal frequencies as EMI frequencies so the signal waveform is distorted.</p>   |
| Filter Combined with Conventional LCs                     | <p>Combinations of inductors and capacitors can yield a steep attenuation characteristic, but they require a great deal more mounting space. Moreover, at high frequencies the EMI suppression is less than that obtained by NFW31S.</p> |

△Note • Please read rating and △CAUTION (for storage, operating, rating, soldering, mounting and handling) in this catalog to prevent smoking and/or burning, etc.  
• This catalog has only typical specifications. Therefore, please approve our product specifications or transact the approval sheet for product specifications before ordering.

# NFR21GD Series 0805/2012 (inch/mm)



3-terminal RC filter, dampens the noise current and returns back to ground.

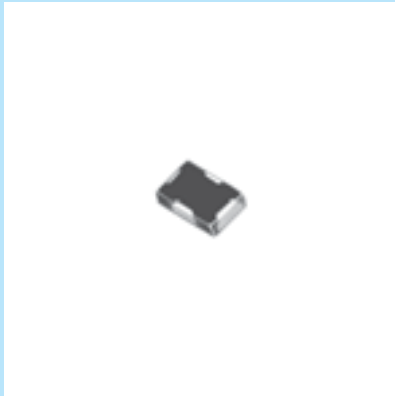

### Dimensions

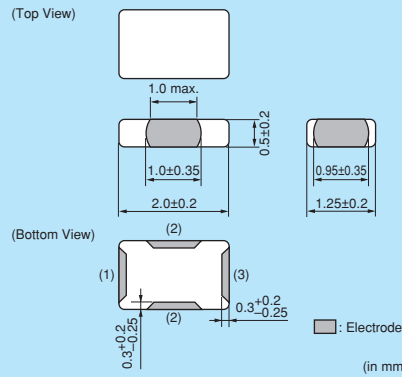

### Equivalent Circuit

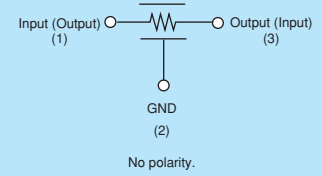

### Packaging

| Code | Packaging                | Minimum Quantity |
|------|--------------------------|------------------|
| L    | 180mm Reel Embossed Tape | 4000             |
| B    | Bulk(Bag)                | 500              |

Refer to pages from p.156 to p.162 for mounting information.

### Rated Value (□: packaging code)

| Part Number     | Capacitance | Resistance  | Rated Current | Rated Voltage | Insulation Resistance (min.) | Operating Temperature Range |
|-----------------|-------------|-------------|---------------|---------------|------------------------------|-----------------------------|
| NFR21GD1002202□ | 10pF ±20%   | 22ohm ±30%  | 50mA          | 50Vdc         | 1000M ohm                    | -40°C to +85°C              |
| NFR21GD1004702□ | 10pF ±20%   | 47ohm ±30%  | 35mA          | 50Vdc         | 1000M ohm                    | -40°C to +85°C              |
| NFR21GD4702202□ | 47pF ±20%   | 22ohm ±30%  | 50mA          | 50Vdc         | 1000M ohm                    | -40°C to +85°C              |
| NFR21GD4704702□ | 47pF ±20%   | 47ohm ±30%  | 35mA          | 50Vdc         | 1000M ohm                    | -40°C to +85°C              |
| NFR21GD4706802□ | 47pF ±20%   | 68ohm ±30%  | 30mA          | 50Vdc         | 1000M ohm                    | -40°C to +85°C              |
| NFR21GD4701012□ | 47pF ±20%   | 100ohm ±30% | 25mA          | 50Vdc         | 1000M ohm                    | -40°C to +85°C              |
| NFR21GD1012202□ | 100pF ±20%  | 22ohm ±30%  | 50mA          | 50Vdc         | 1000M ohm                    | -40°C to +85°C              |
| NFR21GD1014702□ | 100pF ±20%  | 47ohm ±30%  | 35mA          | 50Vdc         | 1000M ohm                    | -40°C to +85°C              |
| NFR21GD1016802□ | 100pF ±20%  | 68ohm ±30%  | 30mA          | 50Vdc         | 1000M ohm                    | -40°C to +85°C              |
| NFR21GD1011012□ | 100pF ±20%  | 100ohm ±30% | 25mA          | 50Vdc         | 1000M ohm                    | -40°C to +85°C              |

Number of Circuit: 1

### Insertion Loss Characteristics

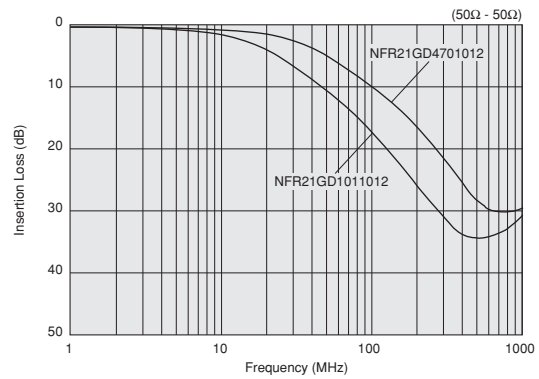
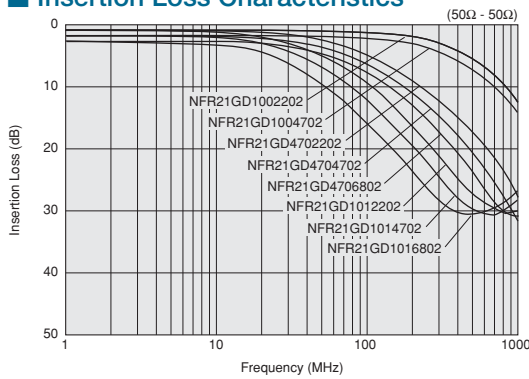

△Note • Please read rating and △CAUTION (for storage, operating, rating, soldering, mounting and handling) in this catalog to prevent smoking and/or burning, etc.  
 • This catalog has only typical specifications. Therefore, please approve our product specifications or transact the approval sheet for product specifications before ordering.

Chip Ferrite Bead

Chip EMIFIL®  
Signal Lines Type

Chip Common Mode Choke Coil

Block Type EMIFIL®

Microwave Absorber

# NFA31GD Series 1206/3216 (inch/mm)



## 3-terminal RC filter array.

### ■ Dimensions

(Top View) (7) (8) (9) (10)

(Bottom View)

0.05 min. 0.05 min. (in mm)

### ■ Equivalent Circuit

Input (Output)

Output (Input)  
No polarity.

### ■ Packaging

| Code | Packaging             | Minimum Quantity |
|------|-----------------------|------------------|
| D    | 180mm Reel Paper Tape | 4000             |
| B    | Bulk(Bag)             | 100              |

Refer to pages from p.156 to p.162 for mounting information.

### ■ Rated Value (□: packaging code)

| Part Number     | Capacitance | Resistance  | Rated Current | Rated Voltage | Insulation Resistance (min.) | Operating Temperature Range |
|-----------------|-------------|-------------|---------------|---------------|------------------------------|-----------------------------|
| NFA31GD1006R84□ | 10pF ±20%   | 6.8ohm ±40% | 50mA          | 6Vdc          | 1000M ohm                    | -40°C to +85°C              |
| NFA31GD1004704□ | 10pF ±20%   | 47ohm ±30%  | 20mA          | 6Vdc          | 1000M ohm                    | -40°C to +85°C              |
| NFA31GD1001014□ | 10pF ±20%   | 100ohm ±30% | 15mA          | 6Vdc          | 1000M ohm                    | -40°C to +85°C              |
| NFA31GD4706R84□ | 47pF ±20%   | 6.8ohm ±40% | 50mA          | 6Vdc          | 1000M ohm                    | -40°C to +85°C              |
| NFA31GD4703304□ | 47pF ±20%   | 33ohm ±30%  | 20mA          | 6Vdc          | 1000M ohm                    | -40°C to +85°C              |
| NFA31GD4704704□ | 47pF ±20%   | 47ohm ±30%  | 20mA          | 6Vdc          | 1000M ohm                    | -40°C to +85°C              |
| NFA31GD4701014□ | 47pF ±20%   | 100ohm ±30% | 15mA          | 6Vdc          | 1000M ohm                    | -40°C to +85°C              |
| NFA31GD1016R84□ | 100pF ±20%  | 6.8ohm ±40% | 50mA          | 6Vdc          | 1000M ohm                    | -40°C to +85°C              |
| NFA31GD1014704□ | 100pF ±20%  | 47ohm ±30%  | 20mA          | 6Vdc          | 1000M ohm                    | -40°C to +85°C              |
| NFA31GD1011014□ | 100pF ±20%  | 100ohm ±30% | 15mA          | 6Vdc          | 1000M ohm                    | -40°C to +85°C              |

Number of Circuit: 4

### ■ Insertion Loss Characteristics

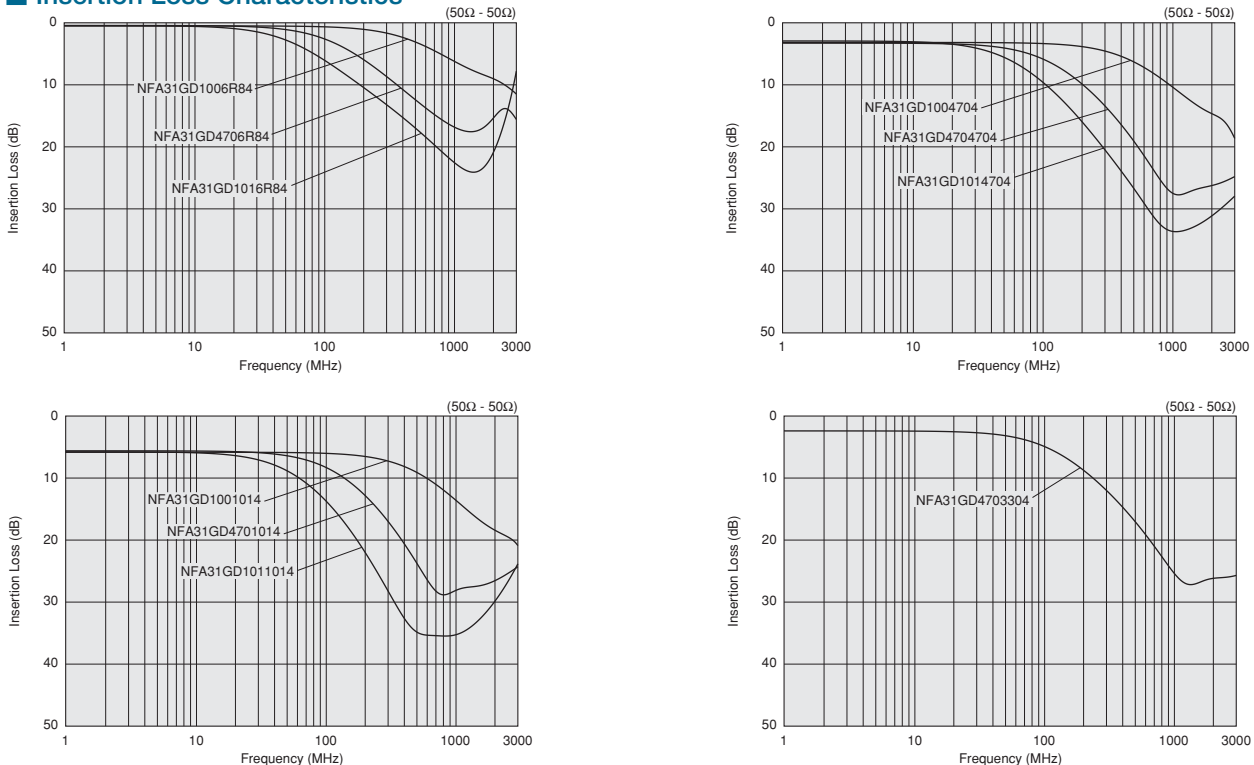

⚠ Note • Please read rating and ⚠ CAUTION (for storage, operating, rating, soldering, mounting and handling) in this catalog to prevent smoking and/or burning, etc.  
• This catalog has only typical specifications. Therefore, please approve our product specifications or transact the approval sheet for product specifications before ordering.

## ⚠ Caution

## ● Rating

Do not use products beyond the rated current and rated voltage as this may create excessive heat and deteriorate the insulation resistance.

## ● Soldering and Mounting

## 1. Self-heating

Please provide special attention when mounting chip EMIFIL® NFM□□P/K series in close proximity to other products that radiate heat.

The heat generated by other products may deteriorate the insulation resistance and cause excessive heat in this component.

## 2. NFL15ST\_X Series Mounting Direction

Mount products in right direction, because products have a direction. Wrong direction which is 180° rotated from right direction cause fuming or partial dispersion, because input or output signal terminals short-circuit to ground.

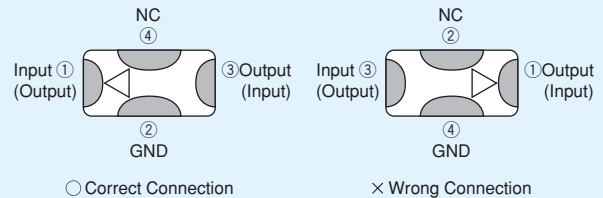

## Notice

## ● Storage and Operating Conditions

## &lt;Operating Environment&gt;

Do not use products in a chemical atmosphere such as chlorine gas, acid or sulfide gas.

Do not use products in the environment close to the organic solvent.

## &lt;Storage and Handling Requirements&gt;

## 1. Storage Period

Should be used within 12 months.

Solderability should be checked if this period is exceeded.

## 2. Storage Conditions

## (1) Storage temperature: -10 to +40°C

Relative humidity: 15 to 85%

Avoid sudden changes in temperature and humidity.

## (2) Do not store products in a chemical atmosphere such as chlorine gas, acid or sulfide gas.

## ● Notice (Soldering and Mounting)

## 1. Cleaning

Failure and degradation of a product are caused by the cleaning method. When you clean in conditions that are not in mounting information, please contact Murata engineering.

## 2. Soldering

Reliability decreases with improper soldering methods. Please solder by the standard soldering conditions shown in mounting information.

## 3. Points of Attention about NFM Pattern Forms

The loaded stresses are different to a chip depend on PCB materials and structures.

When the chip will be mounted on the metal PCB contained alumina material, PCB heat expansion/contraction will be a cause of chip cracks because the coefficients of thermal expressions are different between metal PCB and the chip itself.

In case of mounting 0402 or smaller size of NFM on single-layered glass epoxy board, chip cracks will be also occurred because of the same reason.

## 4. Component Mounting: 0402 size or smaller of NFM

If low bottom dead point of the pick-up nozzle is too low, chip cracks will be occurred because an extra power will be added to the chip during mounting. Therefore, the bottom dead point of pick-up nozzle must be set on/over the upper surface of the PCB. Adjusting is required when the bottom dead point will be set by correcting board warp. It is recommended that using the larger pick-up nozzle than chip length for avoiding what force impact will be centered to the middle point of components. Before assembling, please confirm its mounting accuracy under the best condition.

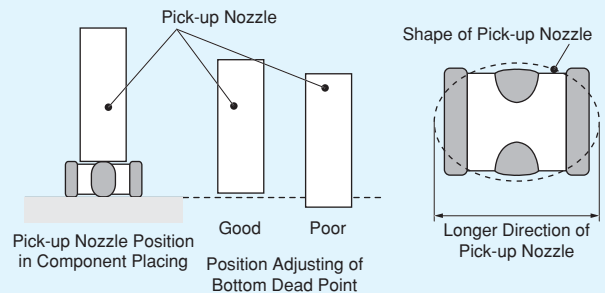

## 5. Other

Noise suppression levels resulting from Murata's EMI suppression filters EMIFIL® may vary, depending on the circuits and ICs used, type of noise, mounting pattern, mounting location, and other operating conditions. Be sure to check and confirm in advance the noise suppression effect of each filter, in actual circuits, etc. before applying the filter in a commercial-purpose equipment design.

Continued on the following page.

⚠ Note • Please read rating and ⚠ CAUTION (for storage, operating, rating, soldering, mounting and handling) in this catalog to prevent smoking and/or burning, etc.  
• This catalog has only typical specifications. Therefore, please approve our product specifications or transact the approval sheet for product specifications before ordering.

**● Handling****1. Resin Coating**

Using resin for coating/molding products may affect the products performance.

So please pay careful attention in selecting resin.

Prior to use, please make the reliability evaluation with the product mounted in your application set.

**2. Caution for Use (NFW Series)**

When you hold products with a tweezer, please hold by the sides. Sharp materials, such as a pair of tweezers or other material such as bristles of cleaning brush, should not touch the winding portion of this product to prevent breaking the wire. Mechanical shock should not be applied to the products mounted on the board to prevent breaking the core.

**3. Handling of a Substrate**

After mounting products on a substrate, do not apply any stress to the product caused by bending or twisting to the substrate when cropping the substrate, inserting and removing a connector from the substrate or tightening screw to the substrate.

Excessive mechanical stress may cause cracking in the Product.

Bending

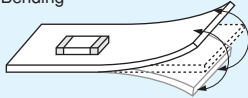

Twisting

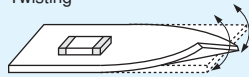

### 1. Standard Land Pattern Dimensions

NF□ series suppress noise by conducting the high-frequency noise element to ground. Therefore, to obtain maximum performance from these filters, the ground pattern should be made as large as possible during the PCB design stage. As shown below, one side of the PCB is used for chip mounting, and the other is used for grounding.

Small diameter feedthrough holes are then used to connect the grounds on each side of the PCB. This reduces the high-frequency impedance of the grounding and maximizes the filter's performance.

Land Pattern + Solder Resist  
 Land Pattern  
 Solder Resist  
 (in mm)

**NFA31CC**  
**NFA31GD**  
**NFM15CC**  
**NFM15PC**  
**NFM18CC**  
**NFM18PC**  
**NFM18PS**  
**NFM21CC**  
**NFM21PC**  
**NFM21PS**  
**NFR21GD**

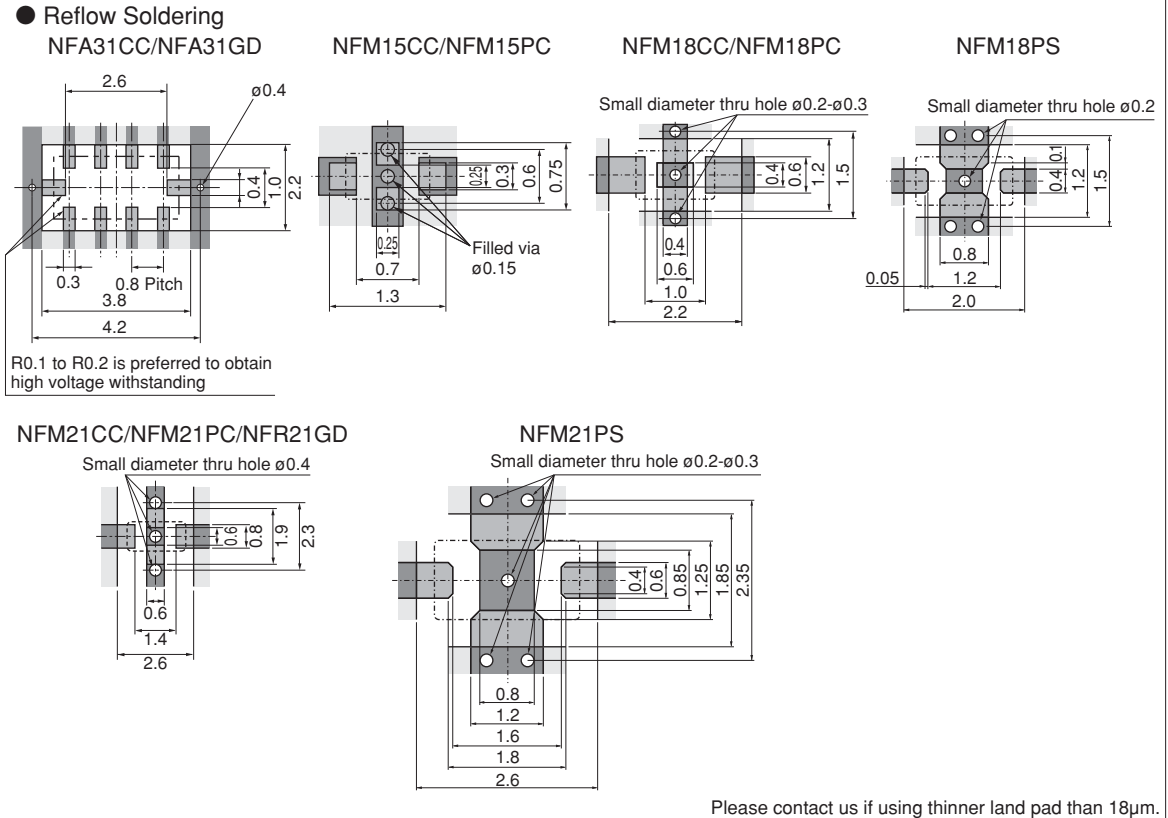

**NFM3DCC**  
**NFM3DPC**  
**NFM31PC**  
**NFM31KC**  
**NFM41CC**  
**NFM41PC**

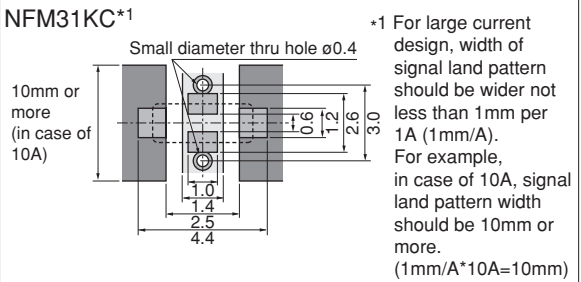
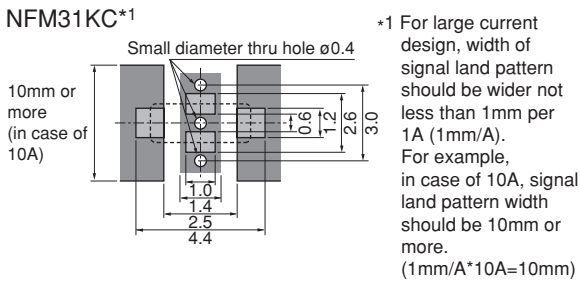
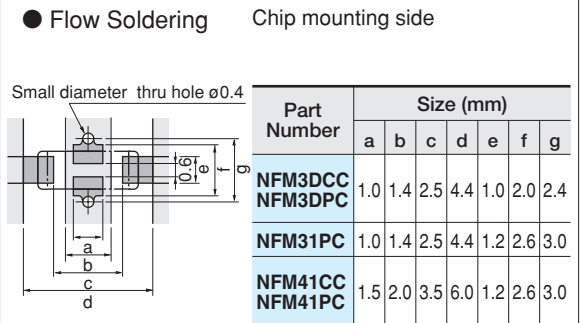
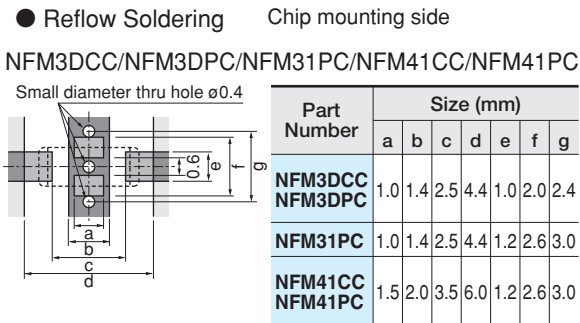

Continued on the following page.

⚠Note • Please read rating and ⚠CAUTION (for storage, operating, rating, soldering, mounting and handling) in this catalog to prevent smoking and/or burning, etc.  
 • This catalog has only typical specifications. Therefore, please approve our product specifications or transact the approval sheet for product specifications before ordering.

Land Pattern + Solder Resist  
 Land Pattern  
 Solder Resist (in mm)

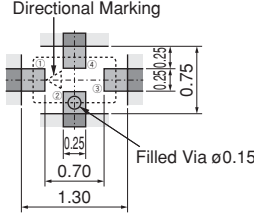
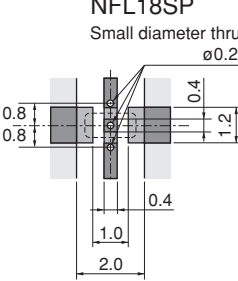
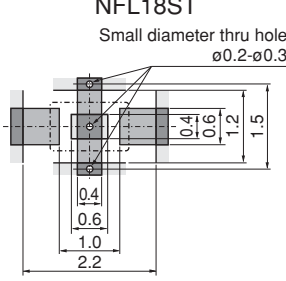
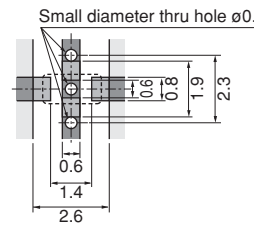
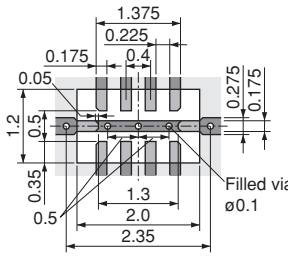
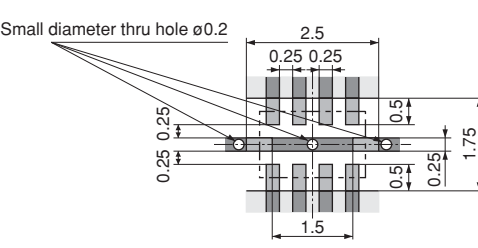
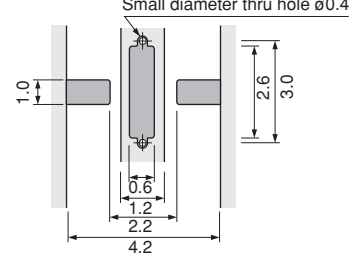
|  |   |
|--|---|
| <p>NFL15ST<br/>NFL18SP<br/>NFL18ST<br/>NFL21SP</p> | <p>● Reflow Soldering<br/>NFL15ST</p>  <p>NFL18SP<br/>Small diameter thru hole ø0.2-ø0.3</p>  <p>NFL18ST<br/>Small diameter thru hole ø0.2-ø0.3</p>  <p>NFL21SP<br/>Small diameter thru hole ø0.4</p>  <p>Please contact us if using thinner land pad than 18µm.</p> |
| <p>NFA18SL<br/>NFA18SD<br/>NFA21SL</p>             | <p>● Reflow Soldering<br/>NFA18SL/NFA18SD</p>  <p>NFA21SL<br/>Small diameter thru hole ø0.2</p>    |
| <p>NFW31SP<br/>NFE31PT</p>                         | <p>● Reflow and Flow NFW31SP<br/>● Reflow Soldering NFE31PT</p> <p>Small diameter thru hole ø0.4</p>   |

Continued on the following page.

⚠Note • Please read rating and ⚠CAUTION (for storage, operating, rating, soldering, mounting and handling) in this catalog to prevent smoking and/or burning, etc.  
 • This catalog has only typical specifications. Therefore, please approve our product specifications or transact the approval sheet for product specifications before ordering.

Land Pattern + Solder Resist  
 Land Pattern  
 Solder Resist (in mm)

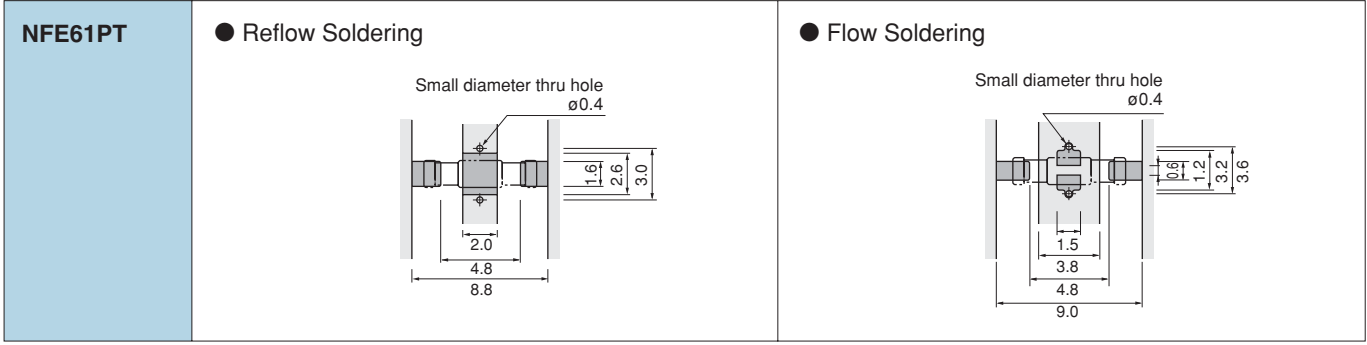

● PCB Warping  
 PCB should be designed so that products are not subjected to the mechanical stress caused by warping the board.

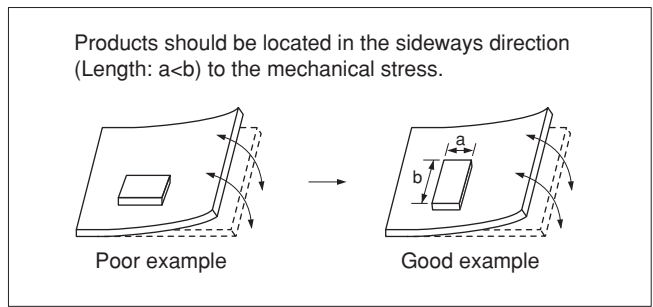

Chip Ferrite Bead

Soldering and Mounting  
Chip EMIFIL®

Chip Common Mode Choke Coil

Block Type EMIFIL®

Microwave Absorber

⚠Note • Please read rating and ⚠CAUTION (for storage, operating, rating, soldering, mounting and handling) in this catalog to prevent smoking and/or burning, etc.  
 • This catalog has only typical specifications. Therefore, please approve our product specifications or transact the approval sheet for product specifications before ordering.



2. Solder Paste Printing and Adhesive Application

When reflow soldering the chip EMI suppression filter, the printing must be conducted in accordance with the following cream solder printing conditions.

If too much solder is applied, the chip will be prone to damage by mechanical and thermal stress from the PCB and may crack.

Standard land dimensions should be used for resist and copper foil patterns.

When flow soldering the EMI suppression filter, apply the adhesive in accordance with the following conditions.

If too much adhesive is applied, then it may overflow into the land or termination areas and yield poor solderability. In contrast, if insufficient adhesive is applied, or if the adhesive is not sufficiently hardened, then the chip may become detached during flow soldering process.

(in mm)

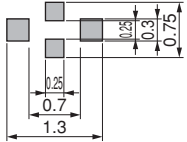
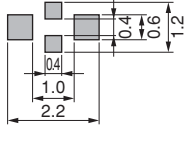
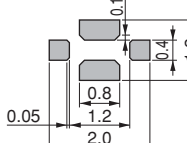
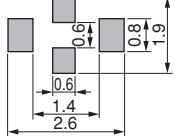
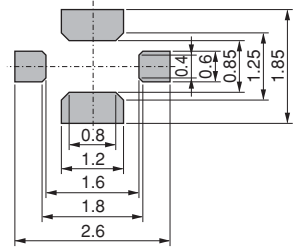
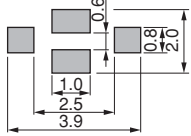
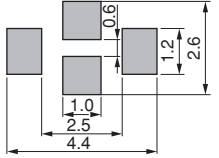
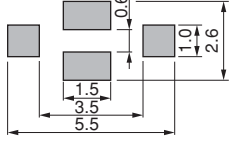
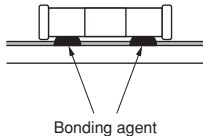
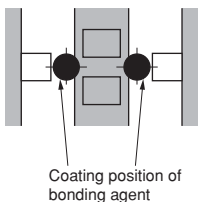
| Series  | Solder Paste Printing  | Adhesive Application   |
|---|--|--|
| <p><b>NFM15CC</b><br/> <b>NFM15PC</b><br/> <b>NFM18CC</b><br/> <b>NFM18PC</b><br/> <b>NFM18PS</b><br/> <b>NFM21CC</b><br/> <b>NFM21PC</b><br/> <b>NFM21PS</b><br/> <b>NFM3DCC</b><br/> <b>NFM3DPC</b><br/> <b>NFM31PC</b><br/> <b>NFM31KC</b><br/> <b>NFM41CC</b><br/> <b>NFM41PC</b><br/> <b>NFR21GD</b></p> | <p>● Guideline of solder paste thickness:<br/>                     100-150µm: NFM15/18/21/3D/31, NFR<br/>                     100-200µm: NFM41</p> <div style="display: flex; justify-content: space-around;"> <div style="text-align: center;"> <p>NFM15CC/15PC</p>  </div> <div style="text-align: center;"> <p>NFM18CC/18PC</p>  </div> </div> <div style="display: flex; justify-content: space-around;"> <div style="text-align: center;"> <p>NFM18PS</p>  </div> <div style="text-align: center;"> <p>NFM21CC/21PC<br/>NFR21GD</p>  </div> </div> <div style="display: flex; justify-content: space-around;"> <div style="text-align: center;"> <p>NFM21PS</p>  </div> <div style="text-align: center;"> <p>NFM3DCC/3DPC</p>  </div> </div> <div style="display: flex; justify-content: space-around;"> <div style="text-align: center;"> <p>NFM31PC/31KC</p>  </div> <div style="text-align: center;"> <p>NFM41CC/41PC</p>  </div> </div> | <p>■ <b>NFM3D/31/41 Series</b><br/>                     Apply 0.1mg for NFM41C/41 and 0.06mg for NFM3D/NFM31 of bonding agent at each chip. Do not cover electrodes.</p> <div style="display: flex; justify-content: space-around;"> <div style="text-align: center;">  <p>Bonding agent</p> </div> <div style="text-align: center;">  <p>Coating position of bonding agent</p> </div> </div> |

Continued on the following page. ↗

⚠ Note • Please read rating and ⚠ CAUTION (for storage, operating, rating, soldering, mounting and handling) in this catalog to prevent smoking and/or burning, etc.  
 • This catalog has only typical specifications. Therefore, please approve our product specifications or transact the approval sheet for product specifications before ordering.

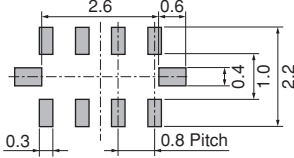
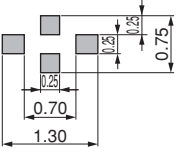
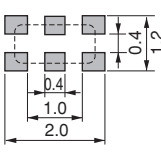
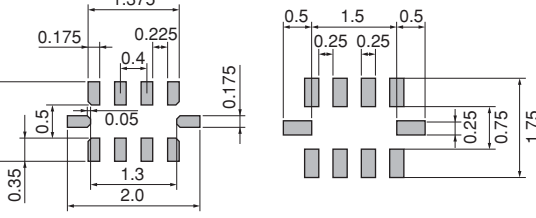
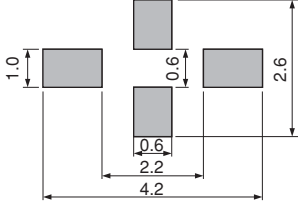
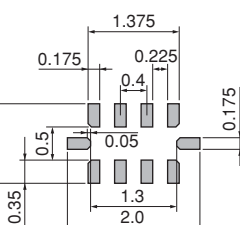
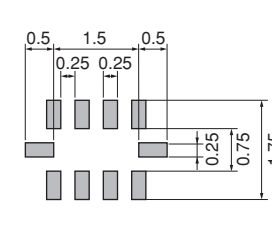
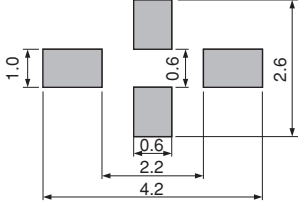
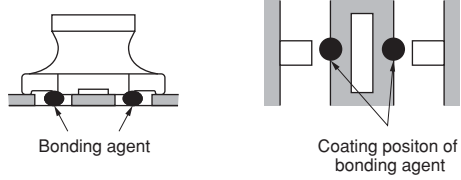
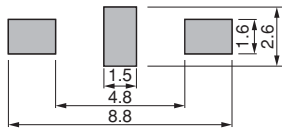
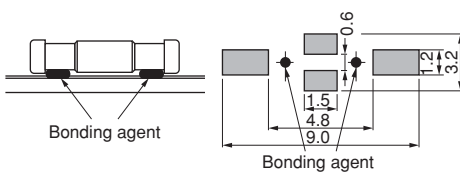
| Series   | Solder Paste Printing   | Adhesive Application   |
|--|---|--|
| <b>NFA31CC</b><br><b>NFA31GD</b>   | <p>●Guideline of solder paste thickness:<br/>100-200µm: NFA31CC/31GD</p> <p>NFA31CC/31GD</p>   |  |
| <b>NFL15ST</b><br><b>NFL18SP</b><br><b>NFL18ST</b><br><b>NFL21SP</b><br><b>NFA18SL</b><br><b>NFA18SD</b><br><b>NFA21SL</b> | <p>●Guideline of solder paste thickness:<br/>100-150µm: NFL, NFA18SL/18SD/21SL</p> <p>NFL15ST</p>  <p>NFL18SP</p>  <p>NFL18ST</p>  <p>NFL21SP</p>  <p>NFA18SL/18SD</p>  <p>NFA21SL</p>  |  |
| <b>NFW31SP</b><br><b>NFE31PT</b>   | <p>●Guideline of solder paste thickness:<br/>150-200µm</p>   | <p>■ <b>NFW31SP Series</b><br/>Apply 0.2mg of bonding agent at each chip.</p>  |
| <b>NFE61PT</b>   | <p>●Guideline of solder paste thickness:<br/>150-200µm</p>   | <p>Apply 1.0mg of bonding agent at each chip.</p>                              |

△Note • Please read rating and △CAUTION (for storage, operating, rating, soldering, mounting and handling) in this catalog to prevent smoking and/or burning, etc.  
• This catalog has only typical specifications. Therefore, please approve our product specifications or transact the approval sheet for product specifications before ordering.

Chip Ferrite Bead

Soldering and Mounting

Chip EMIFIL®

Chip Common Mode Choke Coil

Block Type EMIFIL®

Microwave Absorber

3. Standard Soldering Conditions

(1) Soldering Methods

Use flow and reflow soldering methods only.  
 Use standard soldering conditions when soldering chip EMI suppression filters.  
 In cases where several different parts are soldered, each having different soldering conditions, use those conditions requiring the least heat and minimum time.

Solder: Use Sn-3.0Ag-0.5Cu solder. Use of Sn-Zn based solder will deteriorate performance of products.  
 If using NFM series with Sn-Zn based solder, please contact Murata in advance.

Flux:

- Use Rosin-based flux.  
 In case of using RA type solder, products should be cleaned completely with no residual flux.
- Do not use strong acidic flux (with chlorine content exceeding 0.20wt%)
- Do not use water-soluble flux.

For additional mounting methods, please contact Murata.

(2) Soldering Profile

● Flow Soldering Profile (Sn-3.0Ag-0.5Cu Solder)

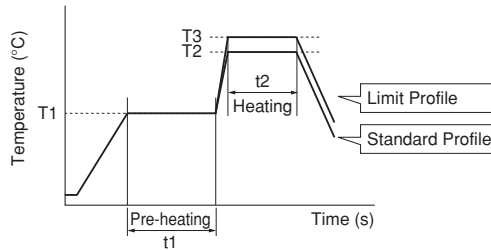

| Series      | Pre-heating |            | Standard Profile |            |               | Limit Profile |            |               |
|-------------|-------------|------------|------------------|------------|---------------|---------------|------------|---------------|
|             | Temp. (T1)  | Time. (t1) | Heating          |            | Cycle of Flow | Heating       |            | Cycle of Flow |
|             |             |            | Temp. (T2)       | Time. (t2) |               | Temp. (T3)    | Time. (t2) |               |
| NFM3D/31/41 | 150°C       | 60s min.   | 250°C            | 4 to 6s    | 2 times max.  | 265±3°C       | 5s max.    | 2 times max.  |
| NFE61PT     | 150°C       | 60s min.   | 250°C            | 4 to 6s    | 2 times max.  | 265±3°C       | 5s max.    | 2 times max.  |
| NFW31SP     | 150°C       | 60s min.   | 250°C            | 4 to 6s    | 2 times max.  | 265±3°C       | 5s max.    | 1 time max.   |

● Reflow Soldering Profile (Sn-3.0Ag-0.5Cu Solder)

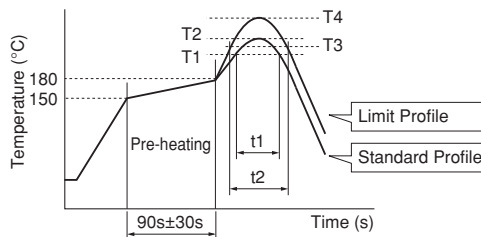

| Series  | Standard Profile |            |                       |                 | Limit Profile |            |                       |                 |
|---|------------------|------------|-----------------------|-----------------|---------------|------------|-----------------------|-----------------|
|   | Heating          |            | Peak Temperature (T2) | Cycle of Reflow | Heating       |            | Peak Temperature (T4) | Cycle of Reflow |
|   | Temp. (T1)       | Time. (t1) |                       |                 | Temp. (T3)    | Time. (t2) |                       |                 |
| NFM<br>NFA31CC/31GD, NFR                            | 220°C min.       | 30 to 60s  | 245±3°C               | 2 times max.    | 230°C min.    | 60s max.   | 260°C/10s             | 2 times max.    |
| NFA18S/21S<br>(Except for NFA31CC/31GD)<br>NFE, NFL | 220°C min.       | 30 to 60s  | 245±3°C               | 2 times max.    | 230°C min.    | 60s max.   | 260°C/10s             | 2 times max.    |
| NFW31SP   | 220°C min.       | 30 to 60s  | 245±3°C               | 2 times max.    | 230°C min.    | 60s max.   | 260°C/10s             | 1 time max.     |

△Note • Please read rating and △CAUTION (for storage, operating, rating, soldering, mounting and handling) in this catalog to prevent smoking and/or burning, etc.  
 • This catalog has only typical specifications. Therefore, please approve our product specifications or transact the approval sheet for product specifications before ordering.

(3) Reworking with Solder Iron

The following conditions must be strictly followed when using a soldering iron.

Pre-heating: 150°C 60s min.

Soldering iron power output / Tip diameter:

30W max. / ø3mm max.\*<sup>1</sup>

\*<sup>1</sup> NFM15: 30W max. / ø2mm max.

Temperature of soldering iron tip / Soldering time / Times:

350°C max. / 3-4s / 2 times\*<sup>2</sup>

\*<sup>2</sup> NFM15: 340°C max. / 3-4s / 1 time

NFE31PT152Z1E9: 280°C max. / 10s max. / 2 times

Do not allow the tip of the soldering iron to directly contact the chip.

For additional methods of reworking with a soldering iron, please contact Murata engineering.

**4. Cleaning**

Following conditions should be observed when cleaning chip EMI filter.

(1) Cleaning Temperature: 60°C max. (40°C max. for alcohol type cleaner)

(2) Ultrasonic

Output: 20W/liter max.

Duration: 5 minutes max.

Frequency: 28 to 40kHz

(3) Cleaning Agent

The following list of cleaning agents have been tested on the individual components. Evaluation of final assembly should be completed prior to production.

(a) Alcohol cleaning agent  
Isopropyl alcohol (IPA)

(b) Aqueous cleaning agent  
Pine Alpha ST-100S

(4) Ensure that flux residue is completely removed.

Component should be thoroughly dried after aqueous agent has been removed with deionized water.

⚠Note • Please read rating and ⚠CAUTION (for storage, operating, rating, soldering, mounting and handling) in this catalog to prevent smoking and/or burning, etc.  
• This catalog has only typical specifications. Therefore, please approve our product specifications or transact the approval sheet for product specifications before ordering.

Chip Ferrite Bead  
Soldering and Mounting  
Chip EMIFIL®  
Chip Common Mode Choke Coil  
Block Type EMIFIL®  
Microwave Absorber

## ■ Minimum Quantity and Dimensions of 8mm Width Paper / Embossed Tape

(Paper Tape)

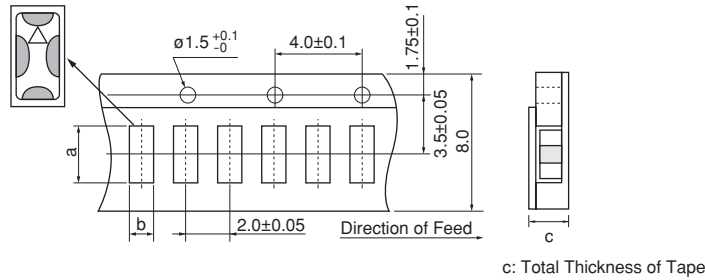

| Part Number | Dimensions |      |          |   | Minimum Qty. (pcs.) |               |             |               | Bulk |
|-------------|------------|------|----------|---|---------------------|---------------|-------------|---------------|------|
|             |            |      |          |   | ø180mm Reel         |               | ø330mm Reel |               |      |
|             | a          | b    | c        | d | Paper Tape          | Embossed Tape | Paper Tape  | Embossed Tape |      |
| NFL15ST     | 1.12       | 0.62 | 0.8 max. | - | 10000               | -             | -           | -             | 500  |

(in mm)

(Common to Paper Tape / Embossed Tape)

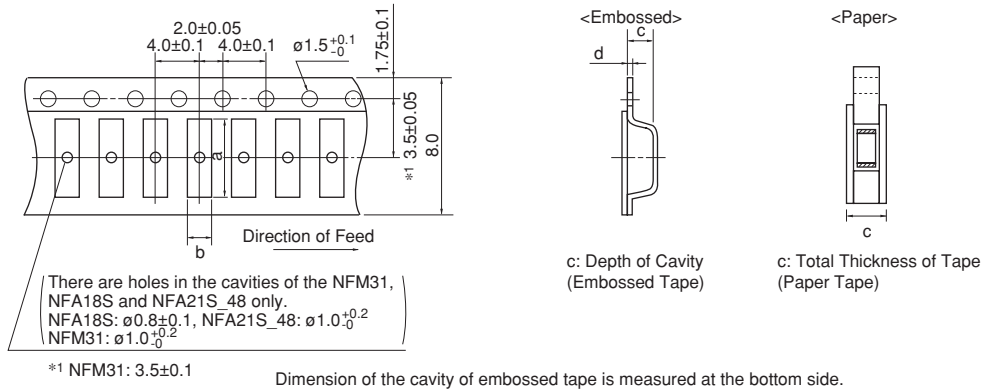

| Part Number   | Dimensions |      |           |      | Minimum Qty. (pcs.) |               |             |               | Bulk |
|---|------------|------|-----------|------|---------------------|---------------|-------------|---------------|------|
|   |            |      |           |      | ø180mm Reel         |               | ø330mm Reel |               |      |
|   | a          | b    | c         | d    | Paper Tape          | Embossed Tape | Paper Tape  | Embossed Tape |      |
| NFM15CC/<br>NFM15PC (Except for 474/105)                | 1.15       | 0.75 | 0.75 max. | -    | 10000               | -             | -           | -             | 500  |
| NFM15PC474/105  | 1.15       | 0.65 | 0.6 max.  | -    | 10000               | -             | -           | -             | 500  |
| NFM18CC/<br>NFM18PC (Except for 105R/225B1A)<br>NFM18PS | 1.85       | 1.05 | 0.9 max.  | -    | 4000                | -             | -           | -             | 500  |
| NFM18PC105R/225B1A                                      |            |      | 1.1 max.  | -    | 4000                | -             | -           | -             | 500  |
| NFL18SP/NFL18ST_H                                       | 1.85       | 1.05 | 0.9 max.  | -    | 4000                | -             | -           | -             | 1000 |
| NFL18ST_X   |            |      | 1.1 max.  |      |                     |               |             |               |      |
| NFL21SP   | 2.3        | 1.55 | 1.1 max.  | -    | -                   | -             | -           | -             | -    |
| NFM21CC/21PC/21PS                                       | 2.3        | 1.55 | 1.1 max.  | -    | 4000                | -             | -           | -             | 500  |
| NFM3DCC/3DPC  | 3.4        | 1.4  | 0.85      | 0.2  | -                   | 4000          | -           | -             | 500  |
| NFM31PC/31KC  | 3.5        | 1.9  | 1.5       | 0.25 | -                   | 3000          | -           | -             | 500  |
| NFA18SL/18SD  | 1.8        | 1.0  | 0.7       | 0.25 | -                   | 4000          | -           | -             | 1000 |
| NFA21SL_45  | 2.30       | 1.55 | 0.7       | 0.25 | -                   | 4000          | -           | -             | 1000 |
| NFA21SL_48  | 2.25       | 1.45 | 1.05      | 0.25 | -                   | 4000          | -           | -             | 1000 |
| NFA31GD/31CC  | 3.5        | 2.0  | 1.1 max.  | -    | 4000                | -             | -           | -             | 100  |
| NFE31PT   | 3.6        | 1.8  | 1.85      | 0.2  | -                   | 2000          | -           | 8000          | 500  |
| NFR21GD   | 2.3        | 1.55 | 0.7       | 0.25 | -                   | 4000          | -           | -             | 500  |
| NFW31SP   | 3.6        | 1.9  | 2.0       | 0.2  | -                   | 2000          | -           | 7500          | -    |

(in mm)

"Minimum Quantity" means the number of units of each delivery or order. The quantity should be an integral multiple of the "Minimum Quantity."

Continued on the following page. 

**Note** • Please read rating and **CAUTION** (for storage, operating, rating, soldering, mounting and handling) in this catalog to prevent smoking and/or burning, etc.  
• This catalog has only typical specifications. Therefore, please approve our product specifications or transact the approval sheet for product specifications before ordering.

■ Minimum Quantity and Dimensions of 12mm Width Embossed Tape

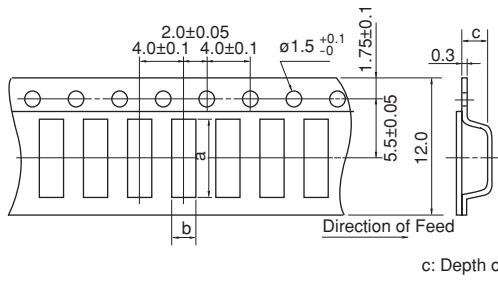

| Part Number  | Dimensions |     |      | Minimum Qty. (pcs.) |             |      |
|--------------|------------|-----|------|---------------------|-------------|------|
|              | a          | b   | c    | ø180mm Reel         | ø330mm Reel | Bulk |
| NFM41CC/41PC | 4.8        | 1.8 | 1.1  | 4000                | -           | 500  |
| NFE61PT      | 7.2        | 1.9 | 1.75 | 2500                | 8000        | 500  |

Dimension of the cavity is measured at the bottom side.

(in mm)

"Minimum Quantity" means the number of units of each delivery or order. The quantity should be an integral multiple of the "Minimum Quantity."

⚠Note • Please read rating and ⚠CAUTION (for storage, operating, rating, soldering, mounting and handling) in this catalog to prevent smoking and/or burning, etc.  
 • This catalog has only typical specifications. Therefore, please approve our product specifications or transact the approval sheet for product specifications before ordering.

Chip Ferrite Bead  
 Packaging  
 Chip EMIFIL®  
 Chip Common Mode Choke Coil  
 Block Type EMIFIL®  
 Microwave Absorber

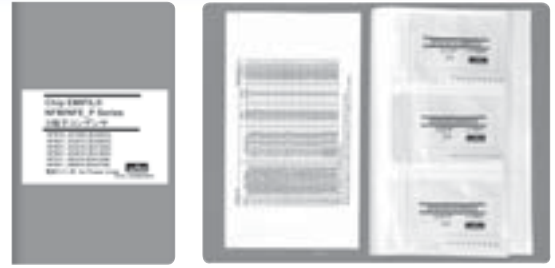

### ●EKEMNFMCC-KIT (Chip EMIFIL® Capacitor Type for Signal Lines)

| No. | Part Number    | Quantity (pcs.) | Capacitance | Rated Voltage (Vdc) | Rated Current (mA) |
|-----|----------------|-----------------|-------------|---------------------|--------------------|
| 1   | NFM15CC222D1A3 | 10              | 2200pF±20%  | 10                  | 1000               |
| 2   | NFM15CC222D1C3 | 10              | 2200pF±20%  | 16                  | 1000               |
| 3   | NFM15CC223C1A3 | 10              | 22000pF±20% | 10                  | 1000               |
| 4   | NFM15CC223C1C3 | 10              | 22000pF±20% | 16                  | 1000               |
| 5   | NFM18CC220U1C3 | 10              | 22pF±20%    | 16                  | 400                |
| 6   | NFM18CC470U1C3 | 10              | 47pF±20%    | 16                  | 400                |
| 7   | NFM18CC101R1C3 | 10              | 100pF±20%   | 16                  | 500                |
| 8   | NFM18CC221R1C3 | 10              | 220pF±20%   | 16                  | 500                |
| 9   | NFM18CC471R1C3 | 10              | 470pF±20%   | 16                  | 500                |
| 10  | NFM18CC102R1C3 | 10              | 1000pF±20%  | 16                  | 600                |
| 11  | NFM18CC222R1C3 | 10              | 2200pF±20%  | 16                  | 700                |
| 12  | NFM18CC223R1C3 | 10              | 22000pF±20% | 16                  | 1000               |
| 13  | NFM21CC220U1H3 | 10              | 22pF±20%    | 50                  | 700                |
| 14  | NFM21CC470U1H3 | 10              | 47pF±20%    | 50                  | 700                |
| 15  | NFM21CC101U1H3 | 10              | 100pF±20%   | 50                  | 700                |
| 16  | NFM21CC221R1H3 | 10              | 220pF±20%   | 50                  | 700                |
| 17  | NFM21CC471R1H3 | 10              | 470pF±20%   | 50                  | 1000               |
| 18  | NFM21CC102R1H3 | 10              | 1000pF±20%  | 50                  | 1000               |
| 19  | NFM21CC222R1H3 | 10              | 2200pF±20%  | 50                  | 1000               |
| 20  | NFM21CC223R1H3 | 10              | 22000pF±20% | 50                  | 2000               |

### ●EKEMFA31E-KIT (Chip EMIFIL® Capacitor Array Type / RC Combined Array Type)

| No. | Part Number    | Quantity (pcs.) | Capacitance | Rated Voltage (Vdc) | Rated Current (mA) |
|-----|----------------|-----------------|-------------|---------------------|--------------------|
| 1   | NFA31CC220S1E4 | 10              | 22pF±20%    | 25                  | 200                |
| 2   | NFA31CC470S1E4 | 10              | 47pF±20%    | 25                  | 200                |
| 3   | NFA31CC101S1E4 | 10              | 100pF±20%   | 25                  | 200                |
| 4   | NFA31CC221S1E4 | 10              | 220pF±20%   | 25                  | 200                |
| 5   | NFA31CC471R1E4 | 10              | 470pF±20%   | 25                  | 200                |
| 6   | NFA31CC102R1E4 | 10              | 1000pF±20%  | 25                  | 200                |
| 7   | NFA31CC222R1E4 | 10              | 2200pF±20%  | 25                  | 200                |
| 8   | NFA31CC223R1C4 | 10              | 22000pF±20% | 16                  | 200                |

### ●EKEMFL18AG-KIT (Chip EMIFIL® LC Combined Type)

| No. | Part Number    | Quantity (pcs.) | Cut-off Frequency | Rated Voltage (Vdc) | Rated Current (mA) |
|-----|----------------|-----------------|-------------------|---------------------|--------------------|
| 1   | NFL15ST157X0J3 | 10              | 150MHz            | 6.3                 | 50                 |
| 2   | NFL15ST207X0J3 | 10              | 200MHz            | 6.3                 | 50                 |
| 3   | NFL15ST307X0J3 | 10              | 300MHz            | 6.3                 | 50                 |
| 4   | NFL15ST507X0J3 | 10              | 500MHz            | 6.3                 | 50                 |
| 5   | NFL18ST506H1A3 | 10              | 50MHz             | 10                  | 75                 |
| 6   | NFL18ST706H1A3 | 10              | 70MHz             | 10                  | 75                 |
| 7   | NFL18ST107H1A3 | 10              | 100MHz            | 10                  | 75                 |
| 8   | NFL18ST207H1A3 | 10              | 200MHz            | 10                  | 100                |
| 9   | NFL18ST307H1A3 | 10              | 300MHz            | 10                  | 100                |
| 10  | NFL18ST507H1A3 | 10              | 500MHz            | 10                  | 100                |
| 11  | NFL18ST207X1C3 | 10              | 200MHz            | 16                  | 150                |
| 12  | NFL18ST307X1C3 | 10              | 300MHz            | 16                  | 200                |
| 13  | NFL18ST507X1C3 | 10              | 500MHz            | 16                  | 200                |
| 14  | NFL18SP157X1A3 | 10              | 150MHz            | 10                  | 100                |
| 15  | NFL18SP207X1A3 | 10              | 200MHz            | 10                  | 100                |
| 16  | NFL18SP307X1A3 | 10              | 300MHz            | 10                  | 100                |
| 17  | NFL18SP507X1A3 | 10              | 500MHz            | 10                  | 100                |
| 18  | NFL21SP106X1C3 | 10              | 10MHz             | 16                  | 100                |
| 19  | NFL21SP206X1C7 | 10              | 20MHz             | 16                  | 100                |

Continued on the following page.

⚠Note • Please read rating and ⚠CAUTION (for storage, operating, rating, soldering, mounting and handling) in this catalog to prevent smoking and/or burning, etc.  
• This catalog has only typical specifications. Therefore, please approve our product specifications or transact the approval sheet for product specifications before ordering.

Continued from the preceding page.

| No. | Part Number    | Quantity (pcs.) | Cut-off Frequency | Rated Voltage (Vdc) | Rated Current (mA) |
|-----|----------------|-----------------|-------------------|---------------------|--------------------|
| 20  | NFL21SP506X1C3 | 10              | 50MHz             | 16                  | 150                |
| 21  | NFL21SP706X1C3 | 10              | 70MHz             | 16                  | 150                |
| 22  | NFL21SP107X1C3 | 10              | 100MHz            | 16                  | 200                |
| 23  | NFL21SP157X1C3 | 10              | 150MHz            | 16                  | 200                |
| 24  | NFL21SP207X1C3 | 10              | 200MHz            | 16                  | 250                |
| 25  | NFL21SP307X1C3 | 10              | 300MHz            | 16                  | 300                |
| 26  | NFL21SP407X1C3 | 10              | 400MHz            | 16                  | 300                |
| 27  | NFL21SP507X1C3 | 10              | 500MHz            | 16                  | 300                |

| No. | Part Number    | Quantity (pcs.) | Cut-off Frequency | Attenuation (dB min.) |          |          |          |          |          |          |          |          |      | Rated Current | Rated Voltage |
|-----|----------------|-----------------|-------------------|-----------------------|----------|----------|----------|----------|----------|----------|----------|----------|------|---------------|---------------|
|     |                |                 |                   | 10MHz                 | 20MHz    | 50MHz    | 100MHz   | 150MHz   | 200MHz   | 300MHz   | 400MHz   | 500MHz   | 1GHz |               |               |
| 28  | NFW31SP106X1E4 | 10              | 10MHz             | 6dB max.              | 5        | 25       | 25       | -        | 25       | -        | -        | 30       | 30   | 200mA         | 25V           |
| 29  | NFW31SP206X1E4 | 10              | 20MHz             | -                     | 6dB max. | 5        | 25       | -        | 25       | -        | -        | 30       | 30   | 200mA         | 25V           |
| 30  | NFW31SP506X1E4 | 10              | 50MHz             | -                     | -        | 6dB max. | 10       | -        | 30       | -        | -        | 30       | 30   | 200mA         | 25V           |
| 31  | NFW31SP107X1E4 | 10              | 100MHz            | -                     | -        | -        | 6dB max. | -        | 5        | -        | -        | 20       | 30   | 200mA         | 25V           |
| 32  | NFW31SP157X1E4 | 10              | 150MHz            | -                     | -        | -        | -        | 6dB max. | -        | 10       | 20       | 30       | 30   | 200mA         | 25V           |
| 33  | NFW31SP207X1E4 | 10              | 200MHz            | -                     | -        | -        | -        | -        | 6dB max. | -        | -        | 10       | 30   | 200mA         | 25V           |
| 34  | NFW31SP307X1E4 | 10              | 300MHz            | -                     | -        | -        | -        | -        | -        | 6dB max. | -        | 5        | 15   | 200mA         | 25V           |
| 35  | NFW31SP407X1E4 | 10              | 400MHz            | -                     | -        | -        | -        | -        | -        | -        | 6dB max. | -        | 10   | 200mA         | 25V           |
| 36  | NFW31SP507X1E4 | 10              | 500MHz            | -                     | -        | -        | -        | -        | -        | -        | -        | 6dB max. | 10   | 200mA         | 25V           |

●EKEMFA20AH-KIT (Chip EMIFIL® LC Combined Array Type)

| No. | Part Number     | Quantity (pcs.) | Cut-off Frequency | Rated Voltage (Vdc) | Rated Current (mA) |
|-----|-----------------|-----------------|-------------------|---------------------|--------------------|
| 1   | NFA18SL506X1A45 | 10              | 50MHz             | 10                  | 25                 |
| 2   | NFA18SL137V1A45 | 10              | 130MHz            | 10                  | 50                 |
| 3   | NFA18SL187V1A45 | 10              | 180MHz            | 10                  | 50                 |
| 4   | NFA18SL207V1A45 | 10              | 200MHz            | 10                  | 50                 |
| 5   | NFA18SL227V1A45 | 10              | 220MHz            | 10                  | 25                 |
| 6   | NFA18SL307V1A45 | 10              | 300MHz            | 10                  | 100                |
| 7   | NFA18SL357V1A45 | 10              | 350MHz            | 10                  | 35                 |
| 8   | NFA18SL407V1A45 | 10              | 400MHz            | 10                  | 100                |
| 9   | NFA18SL487V1A45 | 10              | 480MHz            | 10                  | 100                |
| 10  | NFA18SD187X1A45 | 10              | 180MHz            | 10                  | 25                 |
| 11  | NFA18SD207X1A45 | 10              | 200MHz            | 10                  | 25                 |
| 12  | NFA21SL506X1A48 | 10              | 50MHz             | 10                  | 20                 |
| 13  | NFA21SL806X1A48 | 10              | 80MHz             | 10                  | 20                 |
| 14  | NFA21SL207X1A45 | 10              | 200MHz            | 10                  | 100                |
| 15  | NFA21SL207X1A48 | 10              | 200MHz            | 10                  | 100                |
| 16  | NFA21SL307X1A45 | 10              | 300MHz            | 10                  | 100                |
| 17  | NFA21SL307X1A48 | 10              | 300MHz            | 10                  | 100                |
| 18  | NFA21SL287V1A45 | 10              | 280MHz            | 10                  | 100                |
| 19  | NFA21SL287V1A48 | 10              | 280MHz            | 10                  | 100                |
| 20  | NFA21SL317V1A45 | 10              | 310MHz            | 10                  | 100                |
| 21  | NFA21SL317V1A48 | 10              | 310MHz            | 10                  | 100                |
| 22  | NFA21SL337V1A45 | 10              | 330MHz            | 10                  | 100                |
| 23  | NFA21SL337V1A48 | 10              | 330MHz            | 10                  | 100                |

●EKEMNFPAN-KIT (Chip EMIFIL® for Large Current)

| No. | Part Number    | Quantity (pcs.) | Capacitance | Rated Voltage (Vdc) | Rated Current (A) |
|-----|----------------|-----------------|-------------|---------------------|-------------------|
| 1   | NFM15CC222D1A3 | 10              | 2200pF±20%  | 10                  | 1                 |
| 2   | NFM15CC222D1C3 | 10              | 2200pF±20%  | 16                  | 1                 |
| 3   | NFM15CC223C1A3 | 10              | 22000pF±20% | 10                  | 1                 |
| 4   | NFM15CC223C1C3 | 10              | 22000pF±20% | 16                  | 1                 |
| 5   | NFM15PC473C1A3 | 10              | 0.047μF±20% | 10                  | 1                 |
| 6   | NFM15PC473C1C3 | 10              | 0.047μF±20% | 16                  | 1                 |
| 7   | NFM15PC104D0J3 | 10              | 0.1μF±20%   | 6.3                 | 2                 |
| 8   | NFM15PC104R1A3 | 10              | 0.1μF±20%   | 10                  | 2                 |
| 9   | NFM15PC224D0J3 | 10              | 0.22μF±20%  | 6.3                 | 2                 |
| 10  | NFM15PC224R1A3 | 10              | 0.22μF±20%  | 10                  | 2                 |
| 11  | NFM15PC474D0G3 | 10              | 0.47μF±20%  | 4                   | 2                 |
| 12  | NFM15PC474R0J3 | 10              | 0.47μF±20%  | 6.3                 | 2                 |
| 13  | NFM15PC105R0G3 | 10              | 1μF±20%     | 4                   | 2                 |
| 14  | NFM15PC435R0E3 | 10              | 4.3μF±20%   | 2.5                 | 2                 |

Continued on the following page.

△Note • Please read rating and △CAUTION (for storage, operating, rating, soldering, mounting and handling) in this catalog to prevent smoking and/or burning, etc.  
• This catalog has only typical specifications. Therefore, please approve our product specifications or transact the approval sheet for product specifications before ordering.

Chip Ferrite Bead

Design Kits  
Chip EMIFIL®

Chip Common Mode Choke Coil

Block Type EMIFIL®

Microwave Absorber



Continued from the preceding page.

| No. | Part Number    | Quantity (pcs.) | Capacitance            | Rated Voltage (Vdc) | Rated Current (A) |
|-----|----------------|-----------------|------------------------|---------------------|-------------------|
| 15  | NFM18PC104R1C3 | 10              | 0.1 $\mu$ F $\pm$ 20%  | 16                  | 2                 |
| 16  | NFM18PC224R0J3 | 10              | 0.22 $\mu$ F $\pm$ 20% | 6.3                 | 2                 |
| 17  | NFM18PC474R0J3 | 10              | 0.47 $\mu$ F $\pm$ 20% | 6.3                 | 2                 |
| 18  | NFM18PC105R0J3 | 10              | 1 $\mu$ F $\pm$ 20%    | 6.3                 | 4                 |
| 19  | NFM18PC225B0J3 | 10              | 2.2 $\mu$ F $\pm$ 20%  | 6.3                 | 2                 |
| 20  | NFM18PC225B1A3 | 10              | 2.2 $\mu$ F $\pm$ 20%  | 10                  | 4                 |
| 21  | NFM18PS474R0J3 | 10              | 0.47 $\mu$ F $\pm$ 20% | 6.3                 | 2                 |
| 22  | NFM18PS105R0J3 | 10              | 1 $\mu$ F $\pm$ 20%    | 6.3                 | 2                 |
| 23  | NFM18PS105D0J3 | 10              | 1 $\mu$ F $\pm$ 20%    | 6.3                 | 2                 |
| 24  | NFM21PC104R1E3 | 10              | 0.1 $\mu$ F $\pm$ 20%  | 25                  | 2                 |
| 25  | NFM21PC224R1C3 | 10              | 0.22 $\mu$ F $\pm$ 20% | 16                  | 2                 |
| 26  | NFM21PC474R1C3 | 10              | 0.47 $\mu$ F $\pm$ 20% | 16                  | 2                 |
| 27  | NFM21PC105B1A3 | 10              | 1 $\mu$ F $\pm$ 20%    | 10                  | 4                 |
| 28  | NFM21PC105B1C3 | 10              | 1 $\mu$ F $\pm$ 20%    | 16                  | 4                 |
| 29  | NFM21PC225B0J3 | 10              | 2.2 $\mu$ F $\pm$ 20%  | 6.3                 | 4                 |
| 30  | NFM21PC475B1A3 | 10              | 4.7 $\mu$ F $\pm$ 20%  | 10                  | 6                 |
| 31  | NFM21PS106B0J3 | 10              | 10 $\mu$ F $\pm$ 20%   | 6.3                 | 4                 |
| 32  | NFM31PC276B0J3 | 10              | 27 $\mu$ F $\pm$ 20%   | 6.3                 | 6                 |
| 33  | NFM41PC204F1H3 | 10              | 0.2 $\mu$ F+80/-20%    | 50                  | 2                 |
| 34  | NFM41PC155B1E3 | 10              | 1.5 $\mu$ F $\pm$ 20%  | 25                  | 6                 |
| 35  | NFM31KC103R1H3 | 10              | 10000pF $\pm$ 20%      | 50                  | 10                |
| 36  | NFM31KC103R2A3 | 10              | 10000pF $\pm$ 20%      | 100                 | 10                |
| 37  | NFM31KC153R1H3 | 10              | 15000pF $\pm$ 20%      | 50                  | 10                |
| 38  | NFM31KC153R2A3 | 10              | 15000pF $\pm$ 20%      | 100                 | 10                |
| 39  | NFM31KC223R1H3 | 10              | 22000pF $\pm$ 20%      | 50                  | 10                |
| 40  | NFM31KC223R2A3 | 10              | 22000pF $\pm$ 20%      | 100                 | 10                |
| 41  | NFM31KC104R1H3 | 10              | 100000pF $\pm$ 20%     | 50                  | 6                 |
| 42  | NFM31KC104R2A3 | 10              | 100000pF $\pm$ 20%     | 100                 | 6                 |
| 43  | NFE31PT152Z1E9 | 10              | 1500pF+50/-20%         | 25                  | 6                 |
| 44  | NFE31PT222Z1E9 | 10              | 2200pF $\pm$ 50%       | 25                  | 6                 |
| 45  | NFE61PT102E1H9 | 10              | 1000pF+80/-20%         | 50                  | 2                 |
| 46  | NFE61PT472C1H9 | 10              | 4700pF+80/-20%         | 50                  | 2                 |

⚠Note • Please read rating and ⚠CAUTION (for storage, operating, rating, soldering, mounting and handling) in this catalog to prevent smoking and/or burning, etc.  
 • This catalog has only typical specifications. Therefore, please approve our product specifications or transact the approval sheet for product specifications before ordering.

# Memo

# DL□/PL□

**Chip Common Mode Choke Coil**  
Large Current Common Mode Choke Coil for Automotive Available

|                              |     |
|------------------------------|-----|
| Series Introduction .....    | 170 |
| Part Numbering .....         | 172 |
| Series Line Up .....         | 174 |
| Product Detail .....         | 177 |
| ⚠Caution/Notice .....        | 203 |
| Soldering and Mounting ..... | 205 |
| Packaging .....              | 212 |
| Design Kits .....            | 214 |

Chip Ferrite Bead

Chip EMIFIL®

Chip Common Mode Choke Coil

Block Type EMIFIL®

Microwave Absorber

⚠Note • Please read rating and ⚠CAUTION (for storage, operating, rating, soldering, mounting and handling) in this catalog to prevent smoking and/or burning, etc.  
• This catalog has only typical specifications. Therefore, please approve our product specifications or transact the approval sheet for product specifications before ordering.

# DL   Series Introduction

Common Mode Current

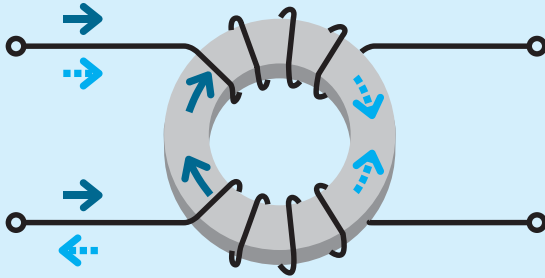

Differential Mode Current

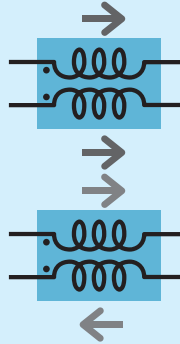

Magnetic flux caused by common mode current accumulates and works as an inductor.

Magnetic flux caused by differential mode current cancel each other and does not work as an inductor.

| Category  | Features, Classification  | Structure                       | Part Number  | Comments  |
|---|---|---------------------------------|--|---|
| High cut-off frequency<br>High Coupling<br>(For high speed differential signal lines) | Ultra high cut-off frequency for high speed differential signal lines | Film type                       | <ul style="list-style-type: none"> <li> DLP0QSA</li> <li> DLP0NSA</li> <li> DLP11SA</li> <li> DLP11RB</li> <li> DLP11TB</li> <li> DLP2ADA</li> </ul> | <ul style="list-style-type: none"> <li>· Low profile, small size, suitable for mobile equipment.</li> <li>· Tight terminal pitch enables high density layout.</li> <li>· Ultra high cut-off frequency and its matching to line impedance enables good transmission of high speed signal.</li> </ul> |
|   |   | Wound type                      | <ul style="list-style-type: none"> <li> DLW21SN_HQ2</li> <li> DLW21HN_HQ2</li> </ul>   | <ul style="list-style-type: none"> <li>· Ultra high self-resonance frequency enables high cut-off frequency.</li> <li>· Its matching to line impedance enables good transmission of high speed signal.</li> </ul>   |
|   | High cut-off frequency for high speed differential signal lines       | Multilayer type                 | DLM11SN  | <ul style="list-style-type: none"> <li>· Enables noise suppression for differential signal line without distortion in high-speed signal transmission.</li> </ul>  |
|   |   | Film type                       | <ul style="list-style-type: none"> <li> DLP0QSN</li> <li> DLP0NS</li> <li> DLP11SN</li> <li> DLP11RN</li> <li> DLP2AD</li> </ul>                     | <ul style="list-style-type: none"> <li>· Low profile, small size, suitable for mobile equipment.</li> <li>· Tight terminal pitch enables high density layout.</li> <li>· High cut-off frequency enables good transmission of high speed signal.</li> </ul>  |
|   |   | Wound type                      | <ul style="list-style-type: none"> <li> DLW21SN_SQ2</li> <li> DLW31S</li> <li> DLW21HN_SQ2</li> </ul>  | <ul style="list-style-type: none"> <li>· Ultra high self-resonance frequency enables high cut-off frequency.</li> <li>· DLW21H is designed as low profile.</li> </ul>   |
|   | For general differential signal lines                                 | Film type                       | <ul style="list-style-type: none"> <li> DLP31S</li> <li> DLP31D</li> </ul>   | <ul style="list-style-type: none"> <li>· Low profile, small size, suitable for mobile equipment.</li> <li>· Tight terminal pitch enables high density layout.</li> </ul>  |
| Large current<br>High coupling<br>(For power lines)                                   |   | Wound type                      | <ul style="list-style-type: none"> <li> DLW5AH</li> <li> DLW5BS</li> <li> DLW5AT</li> <li> DLW5BT</li> </ul>   | <ul style="list-style-type: none"> <li>· Large current (6A max.), suitable for input connector from an AC adaptor.</li> <li>· DLW5AT/DLW5BT is designed as low profile.</li> </ul>  |
| Relative high differential mode impedance<br>Low coupling<br>(For audio lines)        |   | Multilayer type                 | DLM11G   | <ul style="list-style-type: none"> <li>· Modified differential mode impedance is higher than other common mode choke coils; this feature makes it possible to suppress both common mode and differential mode noise.</li> <li>· Ideal to keep low distortion audio signal.</li> </ul>               |
| Large current<br>Automotive Available<br>(For power lines)                            | Available up to 18A   | Winding type<br>Cased structure | PLT10HH  | <ul style="list-style-type: none"> <li>· Large current, high reliability, suitable for motors in automobiles.</li> </ul>  |

△Note • Please read rating and △CAUTION (for storage, operating, rating, soldering, mounting and handling) in this catalog to prevent smoking and/or burning, etc.  
• This catalog has only typical specifications. Therefore, please approve our product specifications or transact the approval sheet for product specifications before ordering.

## Skew Improvement Effect of Common Mode Choke Coil

Example of Skew Improvement by Common Mode Choke Coil (Tested using pulse generator waveform)

Waveform is equivalent to 1000Mbps signal

Waveform with intentionally made skew (skew: 100ps)

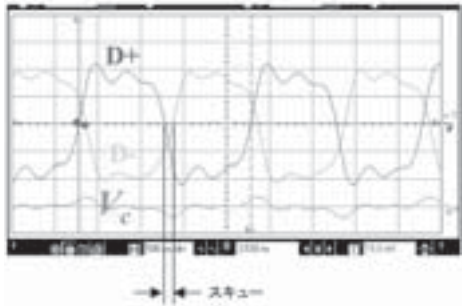

Skew is improved by common mode choke coil

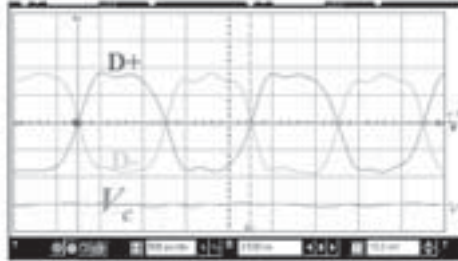

### Mechanism of Skew Improvement

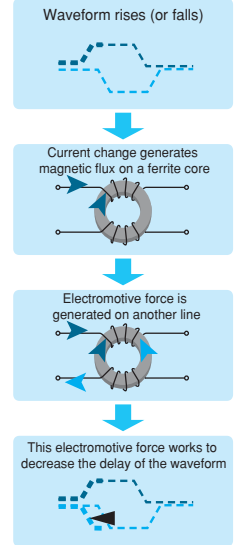

## Noise Suppression of Common Mode Choke Coil in HDMI Line

Device under test / Transmitter : game machine

/ Receiver : projector

/ Cable : HDMI category 2 3m cable

Test resolution / 1080p Deep color 12bit (Data 1.11GHz) DVD play mode

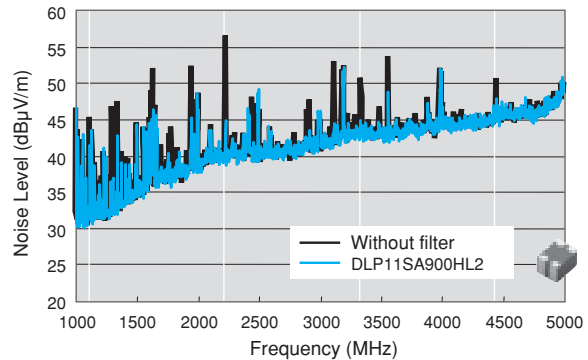
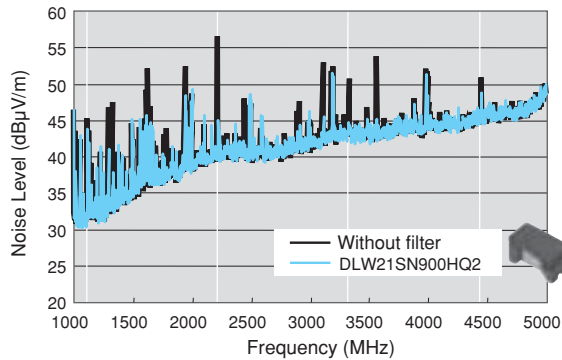

## Test Example of HDMI1.3 Waveform Transmission

~Using ESD protection device

LXES15AAA1-100 (0.05pF)~

Signal frequency : 1.11GHz (Deep color 12bit)

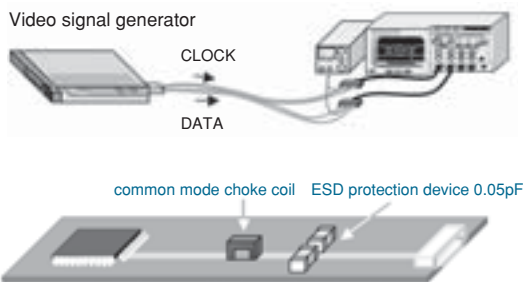

ESD protection device only

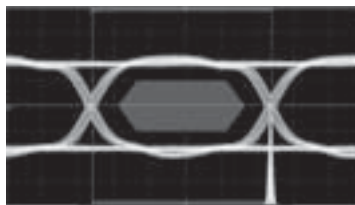

Film Type DLP11SN900HL2 (Cut-off frequency is lowest in the table below)



|                   | Wound Type<br>DLW21SN900HQ2            | Film Type<br>DLP11SA900HL2             | Film Type Array<br>DLP2ADN900HL4      |
|-------------------|--|--|---------------------------------------|
| Cut-off Frequency | Over 10GHz                             | Around 6GHz                            | Around 4GHz                           |
| Judge             | Specification satisfied                | Specification satisfied                | Specification satisfied               |
| Transition Time   | Rise time: 83.4ps<br>Fall time: 77.4ps | Rise time: 90.4ps<br>Fall time: 85.5ps | Rise time: 100ps<br>Fall time: 97.4ps |

Each common mode choke coil can keep the waveform and satisfy the specification.

△Note • Please read rating and △CAUTION (for storage, operating, rating, soldering, mounting and handling) in this catalog to prevent smoking and/or burning, etc.  
• This catalog has only typical specifications. Therefore, please approve our product specifications or transact the approval sheet for product specifications before ordering.

# DL   Chip Common Mode Choke Coil Part Numbering

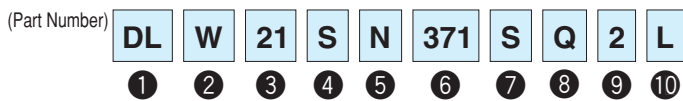

## ① Product ID

| Product ID |                              |
|------------|------------------------------|
| DL         | Chip Common Mode Choke Coils |

## ② Structure

| Code | Structure       |
|------|-----------------|
| W    | Wire Wound Type |
| M    | Multilayer Type |
| P    | Film Type       |

## ③ Dimensions (L×W)

| Code | Dimensions (L×W) | EIA    |
|------|------------------|--------|
| 0Q   | 0.65×0.5mm       | 025020 |
| 0N   | 0.85×0.65mm      | 03025  |
| 11   | 1.25×1.0mm       | 0504   |
| 1N   | 1.5×0.65mm       | 05025  |
| 21   | 2.0×1.2mm        | 0805   |
| 2A   | 2.0×1.0mm        | 0804   |
| 31   | 3.2×1.6mm        | 1206   |
| 43   | 4.5×3.2mm        | 1812   |
| 5A   | 5.0×3.6mm        | 2014   |
| 5B   | 5.0×5.0mm        | 2020   |

## ④ Features (1)

| Code | Type                                   |
|------|--|
| S    | Magnetically Shielded One Circuit Type |
| D    | Magnetically Shielded Two Circuit Type |
| H    | Open Magnetic One Circuit Type         |
| G    | Magnetically Shielded Audio Type       |
| R/T  | One Circuit Low Profile Type           |

## ⑩ Packaging

| Code | Packaging                     | Series               |
|------|-------------------------------|----------------------|
| K    | Embossed Taping (ø330mm Reel) | DLW5AH/DLW5BS/DLW5BT |
| L    | Embossed Taping (ø180mm Reel) | All Series           |
| B    | Bulk                          | All Series           |
| D    | Paper Taping (ø180mm Reel)    | DLP0QS/DLM11G        |

## ⑤ Category

| Code | Category               |
|------|------------------------|
| A    | Expressed by a letter. |
| B    |                        |
| C    |                        |
| H    |                        |
| M    |                        |
| N    |                        |
| R    |                        |

## ⑥ Impedance

Typical impedance at 100MHz is expressed by three figures. The unit is in ohm ( $\Omega$ ). The first and second figures are significant digits, and the third figure expresses the number of zeros that follow the two figures.

## ⑥ Inductance (DLW43SH)

Expressed by three figures. The unit is micro-henry ( $\mu\text{H}$ ). The first and second figures are significant digits, and the third figure expresses the number of zeros which follow the two figures.

## ⑦ Circuit

| Code | Circuit                |
|------|------------------------|
| S    | Expressed by a letter. |
| M    |                        |
| H    |                        |
| U    |                        |
| T    |                        |
| X    |                        |

## ⑧ Features (2)

| Code | Features               |
|------|------------------------|
| D    | Expressed by a letter. |
| K    |                        |
| P    |                        |
| L    |                        |
| Q    |                        |
| Y    |                        |

## ⑨ Number of Signal Lines

| Code | Number of Signal Lines |
|------|------------------------|
| 2    | Two Lines              |
| 4    | Four Lines             |

⚠Note • Please read rating and ⚠CAUTION (for storage, operating, rating, soldering, mounting and handling) in this catalog to prevent smoking and/or burning, etc.  
• This catalog has only typical specifications. Therefore, please approve our product specifications or transact the approval sheet for product specifications before ordering.

# PL   Common Mode Choke Coil Part Numbering

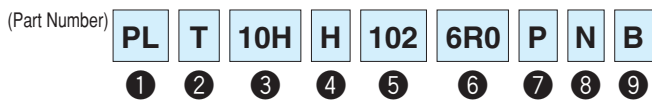

## ① Product ID

| Product ID |                         |
|------------|-------------------------|
| PL         | Common Mode Choke Coils |

## ② Type

| Code | Type    |
|------|---------|
| T    | DC Type |

## ③ Applications

| Code | Applications                    |
|------|---------------------------------|
| 10H  | for DC Line High-frequency Type |

## ④ Features

| Code | Features       |
|------|----------------|
| H    | for Automotive |

## ⑨ Packaging

| Code | Packaging                            | Series |
|------|--------------------------------------|--------|
| B    | Bulk                                 | PLT10H |
| L    | Embossed Taping (ø178mm/ø180mm Reel) | PLT10H |
| K    | Embossed Taping (ø330mm Reel)        | PLT10H |

## ⑤ Impedance

Expressed by three figures. The unit is ohm ( $\Omega$ ). The first and second figures are significant digits, and the third figure expresses the number of zeros that follow the two figures.

## ⑥ Rated Current

Expressed by three figures. The unit is ampere (A). The first and second figures are significant digits, and the third figure expresses the number of zeros that follow the two figures. A decimal point is expressed by the capital letter "R." In this case, all figures are significant digits.

## ⑦ Winding Mode

| Code | Winding Mode         |
|------|----------------------|
| P    | Aligned Winding Type |

## ⑧ Lead Dimensions

| Code | Lead Dimensions        |
|------|------------------------|
| N    | No Lead Terminal (SMD) |

**Note** • Please read rating and **CAUTION** (for storage, operating, rating, soldering, mounting and handling) in this catalog to prevent smoking and/or burning, etc.  
 • This catalog has only typical specifications. Therefore, please approve our product specifications or transact the approval sheet for product specifications before ordering.

| Type  | Size Code<br>in inch (in mm) | Thickness<br>(mm) | Part Number   | Common Mode Impedance<br>(at 100MHz/20°C) | Rated Current | New | Kit | $\geq 1A$ | Hd             | Z <sub>match</sub> | Flow    | RefFlow |
|---|------------------------------|-------------------|---------------|---|---------------|-----|-----|-----------|----------------|--------------------|---------|---------|
|   |                              |                   |               |   |               |     |     | $\geq 3A$ | U <sub>D</sub> |                    |         |         |
| Multilayer Type for Audio Lines               | 0504(1210) <i>p184</i>       | 0.5               | DLM11GN601SD2 | 600ohm±25%                                | 100mA         |     |     |           |                |                    |         | RefFlow |
| Multilayer Type for Differential Signal Lines | 0504(1210) <i>p185</i>       | 0.5               | DLM11SN450HY2 | 45ohm±25%                                 | 100mA         |     | Kit |           | Hd             | Z <sub>match</sub> |         | RefFlow |
|   |                              | 0.5               | DLM11SN900HY2 | 90ohm±25%                                 | 100mA         |     | Kit |           | Hd             | Z <sub>match</sub> |         | RefFlow |
| Chip Ferrite Bead                             | 025020(0605) <i>p186</i>     | 0.3               | DLP0QSN600HL2 | 60ohm±25%                                 | 50mA          |     | Kit |           | Hd             | Z <sub>match</sub> |         | RefFlow |
|   |                              | 0.3               | DLP0QSA070HL2 | 7ohm±2ohm                                 | 100mA         |     | Kit |           | U <sub>D</sub> | Z <sub>match</sub> |         | RefFlow |
|   |                              | 0.3               | DLP0QSA150HL2 | 15ohm±5ohm                                | 100mA         |     | Kit |           | U <sub>D</sub> | Z <sub>match</sub> |         | RefFlow |
|   |                              | 0.3               | DLP0QSA350HL2 | 35ohm±10ohm                               | 100mA         |     | Kit |           | U <sub>D</sub> | Z <sub>match</sub> |         | RefFlow |
|   |                              | 0.45              | DLP0NSC280HL2 | 28ohm±20%                                 | 100mA         |     | Kit |           | Hd             | Z <sub>match</sub> |         | RefFlow |
|   | 03025(0806) <i>p187</i>      | 0.45              | DLP0NSN350HL2 | 35ohm±10ohm                               | 100mA         |     | Kit |           | Hd             | Z <sub>match</sub> |         | RefFlow |
|   |                              | 0.45              | DLP0NSN670HL2 | 67ohm±20%                                 | 110mA         |     | Kit |           | Hd             | Z <sub>match</sub> |         | RefFlow |
|   |                              | 0.45              | DLP0NSN900HL2 | 90ohm±20%                                 | 100mA         |     | Kit |           | Hd             | Z <sub>match</sub> |         | RefFlow |
|   |                              | 0.45              | DLP0NSN121HL2 | 120ohm±20%                                | 90mA          |     | Kit |           | Hd             | Z <sub>match</sub> |         | RefFlow |
|   |                              | 0.45              | DLP0NSA070HL2 | 7ohm±2ohm                                 | 100mA         |     | Kit |           | U <sub>D</sub> | Z <sub>match</sub> |         | RefFlow |
| Film Type for Differential Signal Lines       | 0504(1210) <i>p189</i>       | 0.82              | DLP11SN670SL2 | 67ohm±20%                                 | 180mA         |     | Kit |           | Hd             |                    |         | RefFlow |
|   |                              | 0.82              | DLP11SN121SL2 | 120ohm±20%                                | 140mA         |     | Kit |           | Hd             |                    |         | RefFlow |
|   |                              | 0.82              | DLP11SN161SL2 | 160ohm±20%                                | 120mA         |     | Kit |           | Hd             |                    |         | RefFlow |
|   |                              | 0.82              | DLP11SN900HL2 | 90ohm±20%                                 | 150mA         |     | Kit |           | Hd             | Z <sub>match</sub> |         | RefFlow |
|   |                              | 0.82              | DLP11SN201HL2 | 200ohm±20%                                | 110mA         |     | Kit |           | Hd             | Z <sub>match</sub> |         | RefFlow |
|   |                              | 0.82              | DLP11SN241HL2 | 240ohm±20%                                | 100mA         |     | Kit |           | Hd             | Z <sub>match</sub> |         | RefFlow |
|   |                              | 0.82              | DLP11SN281HL2 | 280ohm±20%                                | 90mA          |     | Kit |           | Hd             | Z <sub>match</sub> |         | RefFlow |
|   |                              | 0.82              | DLP11SN331HL2 | 330ohm±20%                                | 80mA          |     | Kit |           | Hd             | Z <sub>match</sub> |         | RefFlow |
|   |                              | 0.82              | DLP11SA350HL2 | 35ohm±20%                                 | 170mA         |     | Kit |           | U <sub>D</sub> | Z <sub>match</sub> |         | RefFlow |
|   |                              | 0.82              | DLP11SA670HL2 | 67ohm±20%                                 | 150mA         |     | Kit |           | U <sub>D</sub> | Z <sub>match</sub> |         | RefFlow |
|   | 1206(3216) <i>p190</i>       | 0.5               | DLP11RN450UL2 | 45ohm±25%                                 | 100mA         |     | Kit |           | Hd             | Z <sub>match</sub> |         | RefFlow |
|   |                              | 0.5               | DLP11RB150UL2 | 15ohm±5ohm                                | 100mA         |     | Kit |           | Hd             | Z <sub>match</sub> |         | RefFlow |
|   |                              | 0.5               | DLP11RB400UL2 | 40ohm±10ohm                               | 100mA         |     | Kit |           | U <sub>D</sub> | Z <sub>match</sub> |         | RefFlow |
|   |                              | 0.3               | DLP11TB800UL2 | 80ohm±25%                                 | 100mA         |     | Kit |           | U <sub>D</sub> | Z <sub>match</sub> |         | RefFlow |
|   |                              | 1.15              | DLP31SN121ML2 | 120ohm±20%                                | 100mA         |     |     |           | Hd             |                    |         | RefFlow |
| Chip Common Mode Choke Coil                   | 1206(3216) <i>p192</i>       | 1.15              | DLP31SN221ML2 | 220ohm±20%                                | 100mA         |     |     |           | Hd             |                    |         | RefFlow |
|   |                              | 1.15              | DLP31SN551ML2 | 550ohm±20%                                | 100mA         |     |     |           | Hd             |                    |         | RefFlow |
|   |                              | 0.45              | DLP1NDN350HL4 | 35ohm±20%                                 | 100mA         |     | Kit |           | Hd             | Z <sub>match</sub> |         | RefFlow |
|   | 05025(1506) <i>p193</i>      | 0.45              | DLP1NDN670HL4 | 67ohm±20%                                 | 80mA          |     | Kit |           | Hd             | Z <sub>match</sub> |         | RefFlow |
|   |                              | 0.45              | DLP1NDN900HL4 | 90ohm±20%                                 | 60mA          |     | Kit |           | Hd             | Z <sub>match</sub> |         | RefFlow |
|   |                              | 0.82              | DLP2ADA350HL4 | 35ohm±20%                                 | 150mA         |     | Kit |           | U <sub>D</sub> | Z <sub>match</sub> |         | RefFlow |
|   | 0804(2010) <i>p194</i>       | 0.82              | DLP2ADA670HL4 | 67ohm±20%                                 | 130mA         |     | Kit |           | U <sub>D</sub> | Z <sub>match</sub> |         | RefFlow |
|   |                              | 0.82              | DLP2ADA900HL4 | 90ohm±20%                                 | 120mA         |     | Kit |           | U <sub>D</sub> | Z <sub>match</sub> |         | RefFlow |
|   |                              | 0.82              | DLP2ADN670HL4 | 67ohm±20%                                 | 140mA         |     | Kit |           | Hd             | Z <sub>match</sub> |         | RefFlow |
|   |                              | 0.82              | DLP2ADN900HL4 | 90ohm±20%                                 | 130mA         |     | Kit |           | Hd             | Z <sub>match</sub> |         | RefFlow |
|   |                              | 0.82              | DLP2ADN121HL4 | 120ohm±20%                                | 120mA         |     | Kit |           | Hd             | Z <sub>match</sub> |         | RefFlow |
|   |                              | 0.82              | DLP2ADN161HL4 | 160ohm±20%                                | 100mA         |     | Kit |           | Hd             | Z <sub>match</sub> |         | RefFlow |
|   |                              | 0.82              | DLP2ADN201HL4 | 200ohm±20%                                | 90mA          |     | Kit |           | Hd             | Z <sub>match</sub> |         | RefFlow |
|   |                              | 0.82              | DLP2ADN241HL4 | 240ohm±20%                                | 80mA          |     | Kit |           | Hd             | Z <sub>match</sub> |         | RefFlow |
|   |                              | 0.82              | DLP2ADN281HL4 | 280ohm±20%                                | 80mA          |     | Kit |           | Hd             | Z <sub>match</sub> |         | RefFlow |
| 1206(3216) <i>p196</i>                        | 1.15                         | DLP31DN900ML4     | 90ohm±20%     | 160mA                                     |               |     |     | Hd        |                |                    | RefFlow |         |
|   | 1.15                         | DLP31DN131ML4     | 130ohm±20%    | 120mA                                     |               |     |     | Hd        |                |                    | RefFlow |         |
|   | 1.15                         | DLP31DN201ML4     | 200ohm±20%    | 100mA                                     |               |     |     | Hd        |                |                    | RefFlow |         |
|   | 1.15                         | DLP31DN321ML4     | 320ohm±20%    | 80mA                                      |               |     |     | Hd        |                |                    | RefFlow |         |
|   | 1.15                         | DLP31DN441ML4     | 440ohm±20%    | 70mA                                      |               |     |     | Hd        |                |                    | RefFlow |         |
| Block Type EMIFIL®                            | 0805(2012) <i>p197</i>       | 1.2               | DLW21SN670SQ2 | 67ohm±25%                                 | 400mA         |     | Kit |           | Hd             |                    |         | RefFlow |
|   |                              | 1.2               | DLW21SN900SQ2 | 90ohm±25%                                 | 330mA         |     | Kit |           | Hd             |                    |         | RefFlow |
|   |                              | 1.2               | DLW21SN121SQ2 | 120ohm±25%                                | 370mA         |     | Kit |           | Hd             |                    |         | RefFlow |
|   |                              | 1.2               | DLW21SN181SQ2 | 180ohm±25%                                | 330mA         |     | Kit |           | Hd             |                    |         | RefFlow |
|   |                              | 1.2               | DLW21SN261SQ2 | 260ohm±25%                                | 300mA         |     | Kit |           | Hd             |                    |         | RefFlow |
|   |                              | 1.2               | DLW21SN371SQ2 | 370ohm±25%                                | 280mA         |     | Kit |           | Hd             |                    |         | RefFlow |
|   |                              | 1.2               | DLW21SN501SK2 | 500ohm±25%                                | 250mA         |     | Kit |           | Hd             |                    |         | RefFlow |
|   |                              | 1.2               | DLW21SN670HQ2 | 67ohm±25%                                 | 320mA         |     | Kit |           | U <sub>D</sub> | Z <sub>match</sub> |         | RefFlow |
|   |                              | 1.2               | DLW21SN900HQ2 | 90ohm±25%                                 | 280mA         |     | Kit |           | U <sub>D</sub> | Z <sub>match</sub> |         | RefFlow |
|   |                              | 1.2               | DLW21SN121HQ2 | 120ohm±25%                                | 280mA         |     | Kit |           | U <sub>D</sub> | Z <sub>match</sub> |         | RefFlow |
| Wire Wound Type for Differential Signal Lines | 0805(2012) <i>p198</i>       | 1.2               | DLW21SN181XQ2 | 180ohm±25%                                | 240mA         | New | Kit |           | Hd             |                    |         | RefFlow |
|   |                              | 1.2               | DLW21SN261XQ2 | 260ohm±25%                                | 220mA         | New | Kit |           | Hd             |                    |         | RefFlow |

Continued on the following page.

△Note • Please read rating and △CAUTION (for storage, operating, rating, soldering, mounting and handling) in this catalog to prevent smoking and/or burning, etc.  
• This catalog has only typical specifications. Therefore, please approve our product specifications or transact the approval sheet for product specifications before ordering.



| Type   | Size Code<br>in inch (in mm)  | Thickness<br>(mm) | Part Number    | Common Mode Impedance<br>(at 100MHz/20°C) | Rated Current | New       | Kit       | $\geq 1A$ | Hd | $\geq 3A$          | Ud   | Z <sub>match</sub> | Flow    | RefFlow |         |
|--|---|-------------------|----------------|---|---------------|-----------|-----------|-----------|----|--------------------|------|--------------------|---------|---------|---------|
| Wire Wound Type<br>for Differential<br>Signal Lines    | 0805(2012)  | p198              | DLW21SN491XQ2  | 490ohm±25%                                | 190mA         | New       | Kit       |           | Hd |                    |      |                    |         | RefFlow |         |
|  |   | p197              | DLW21SR670HQ2  | 67ohm±25%                                 | 400mA         |           | Kit       |           | Ud | Z <sub>match</sub> |      |                    |         | RefFlow |         |
|  |   | p199              | DLW21HN670SQ2  | 67ohm±25%                                 | 330mA         |           | Kit       |           | Hd |                    |      |                    |         | RefFlow |         |
|  |   |                   | DLW21HN900SQ2  | 90ohm±25%                                 | 330mA         |           | Kit       |           | Hd |                    |      |                    |         | RefFlow |         |
|  |   |                   | DLW21HN121SQ2  | 120ohm±25%                                | 280mA         |           | Kit       |           | Hd |                    |      |                    |         | RefFlow |         |
|  |   |                   | DLW21HN181SQ2  | 180ohm±25%                                | 250mA         |           | Kit       |           | Hd |                    |      |                    |         | RefFlow |         |
|  |   |                   | DLW21HN670HQ2  | 67ohm±25%                                 | 240mA         |           | Kit       |           | Ud | Z <sub>match</sub> |      |                    |         | RefFlow |         |
|  |   |                   | DLW21HN900HQ2  | 90ohm±25%                                 | 220mA         |           | Kit       |           | Ud | Z <sub>match</sub> |      |                    |         | RefFlow |         |
|  | 1206(3216)  | p200              | DLW31SN900SQ2  | 90ohm±25%                                 | 370mA         |           |           |           | Hd |                    |      |                    |         | RefFlow |         |
|  |   |                   | DLW31SN161SQ2  | 160ohm±25%                                | 340mA         |           |           |           | Hd |                    |      |                    |         | RefFlow |         |
|  |   |                   | DLW31SN261SQ2  | 260ohm±25%                                | 310mA         |           |           |           | Hd |                    |      |                    |         | RefFlow |         |
|  |   |                   | DLW31SN601SQ2  | 600ohm±25%                                | 260mA         |           |           |           | Hd |                    |      |                    |         | RefFlow |         |
|  |   |                   | DLW31SN102SQ2  | 1000ohm±25%                               | 230mA         |           |           |           | Hd |                    |      |                    |         | RefFlow |         |
|  |   |                   | DLW31SN222SQ2  | 2200ohm±25%                               | 200mA         |           |           |           | Hd |                    |      |                    |         | RefFlow |         |
|  | Wire Wound Type for<br>Differential Signal Lines<br>Automotive Type | 1812(4532)        | p201           | DLW43SH110XK2                             | -             | 360mA     |           |           |    |                    |      |                    |         |         | RefFlow |
|  |   |                   |                | DLW43SH220XK2                             | -             | 310mA     |           |           |    |                    |      |                    |         |         | RefFlow |
|  |   |                   | DLW43SH510XK2  | -   | 230mA         |           |           |           |    |                    |      |                    |         | RefFlow |         |
|  |   |                   | DLW43SH101XK2  | -   | 200mA         |           |           |           |    |                    |      |                    |         | RefFlow |         |
|  |   |                   | DLW43SH101XP2  | -   | 170mA         |           |           |           |    |                    |      |                    |         | RefFlow |         |
| Wire Wound Type<br>for Power Lines<br>and Signal Lines | 2014(5036)  | p177              | DLW5AHN402SQ2  | 4000ohm (Typ.)                            | 200mA         |           | Kit       |           |    |                    |      |                    |         | RefFlow |         |
|  |   | p179              | DLW5ATN111SQ2  | 110ohm (Typ.)                             | 5000mA        |           | Kit       | $\geq 3A$ |    |                    |      |                    |         | RefFlow |         |
|  |   |                   | DLW5ATN401SQ2  | 400ohm (Typ.)                             | 2000mA        |           | Kit       | $\geq 1A$ |    |                    |      |                    |         | RefFlow |         |
|  |   |                   | DLW5ATN501SQ2  | 500ohm (Typ.)                             | 1500mA        |           | Kit       | $\geq 1A$ |    |                    |      |                    |         | RefFlow |         |
|  |   |                   | DLW5ATN851SQ2  | 850ohm (Typ.)                             | 1500mA        |           | Kit       | $\geq 1A$ |    |                    |      |                    |         | RefFlow |         |
|  |   |                   | DLW5ATN272SQ2  | 2700ohm (Typ.)                            | 1000mA        |           | Kit       | $\geq 1A$ |    |                    |      |                    |         | RefFlow |         |
|  |   | p182              | DLW5ATN500MQ2  | 50ohm (Typ.)                              | 6000mA        |           | Kit       | $\geq 3A$ |    |                    | Flow | RefFlow            |         |         |         |
|  |   |                   | DLW5ATN151MQ2  | 150ohm (Typ.)                             | 5000mA        |           | Kit       | $\geq 3A$ |    |                    | Flow | RefFlow            |         |         |         |
|  |   |                   | DLW5ATN331MQ2  | 330ohm (Typ.)                             | 4000mA        |           | Kit       | $\geq 3A$ |    |                    | Flow | RefFlow            |         |         |         |
|  |   |                   | DLW5ATN501MQ2  | 500ohm (Typ.)                             | 2500mA        | New       | Kit       | $\geq 1A$ |    |                    | Flow | RefFlow            |         |         |         |
|  |   |                   | DLW5ATN112MQ2  | 1100ohm (Typ.)                            | 2000mA        |           | Kit       | $\geq 1A$ |    |                    | Flow | RefFlow            |         |         |         |
|  |   |                   | DLW5ATN111TQ2  | 100ohm (Typ.)                             | 5000mA        |           | Kit       | $\geq 3A$ |    |                    |      | RefFlow            |         |         |         |
|  | 2020(5050)  |                   | DLW5ATN231TQ2  | 230ohm (Typ.)                             | 4000mA        |           | Kit       | $\geq 3A$ |    |                    |      |                    |         | RefFlow |         |
|  |   |                   | DLW5ATN401TQ2  | 400ohm (Typ.)                             | 2500mA        | New       | Kit       | $\geq 1A$ |    |                    |      |                    |         | RefFlow |         |
|  |   |                   | DLW5ATN501TQ2  | 500ohm (Typ.)                             | 2000mA        |           | Kit       | $\geq 1A$ |    |                    |      |                    |         | RefFlow |         |
|  |   | p177              | DLW5BSM501TQ2  | 500ohm (Typ.)                             | 1000mA        | New       | Kit       | $\geq 1A$ |    |                    |      |                    |         | RefFlow |         |
|  |   |                   | DLW5BSM601TQ2  | 600ohm (Typ.)                             | 1400mA        | New       | Kit       | $\geq 1A$ |    |                    |      |                    |         | RefFlow |         |
|  |   |                   | DLW5BSM801TQ2  | 800ohm (Typ.)                             | 2000mA        | New       | Kit       | $\geq 1A$ |    |                    |      |                    |         | RefFlow |         |
|  |   |                   | DLW5BSM191SQ2  | 190ohm (Typ.)                             | 5000mA        |           | Kit       | $\geq 3A$ |    |                    |      |                    |         | RefFlow |         |
|  |   |                   | DLW5BSM351SQ2  | 350ohm (Typ.)                             | 2000mA        |           | Kit       | $\geq 1A$ |    |                    |      |                    |         | RefFlow |         |
|  |   |                   | DLW5BSM102SQ2  | 1000ohm (Typ.)                            | 1500mA        |           | Kit       | $\geq 1A$ |    |                    |      |                    |         | RefFlow |         |
|  |   |                   | DLW5BSM152SQ2  | 1500ohm (Typ.)                            | 1000mA        |           | Kit       | $\geq 1A$ |    |                    |      |                    |         | RefFlow |         |
|  |   |                   | DLW5BSM302SQ2  | 3000ohm (Typ.)                            | 500mA         |           | Kit       |           |    |                    |      |                    |         | RefFlow |         |
|  |   | p179              | DLW5BTM101SQ2  | 100ohm (Typ.)                             | 6000mA        |           | Kit       | $\geq 3A$ |    |                    |      |                    |         | RefFlow |         |
| p182   |   | DLW5BTM251SQ2     | 250ohm (Typ.)  | 5000mA                                    |               | Kit       | $\geq 3A$ |           |    |                    |      |                    | RefFlow |         |         |
|  |   | DLW5BTM501SQ2     | 500ohm (Typ.)  | 4000mA                                    |               | Kit       | $\geq 3A$ |           |    |                    |      |                    | RefFlow |         |         |
|  |   | DLW5BTM102SQ2     | 1000ohm (Typ.) | 2000mA                                    |               | Kit       | $\geq 1A$ |           |    |                    |      |                    | RefFlow |         |         |
|  |   | DLW5BTM142SQ2     | 1400ohm (Typ.) | 1500mA                                    |               | Kit       | $\geq 1A$ |           |    |                    |      |                    | RefFlow |         |         |
|  |   | DLW5BTM101TQ2     | 100ohm (Typ.)  | 6000mA                                    |               | Kit       | $\geq 3A$ |           |    |                    |      |                    | RefFlow |         |         |
|  |   | DLW5BTM251TQ2     | 250ohm (Typ.)  | 5000mA                                    |               | Kit       | $\geq 3A$ |           |    |                    |      |                    | RefFlow |         |         |
|  |   | DLW5BTM501TQ2     | 500ohm (Typ.)  | 4000mA                                    |               | Kit       | $\geq 3A$ |           |    |                    |      |                    | RefFlow |         |         |
|  |   | DLW5BTM102TQ2     | 1000ohm (Typ.) | 2500mA                                    | New           | Kit       | $\geq 1A$ |           |    |                    |      |                    | RefFlow |         |         |
|  | DLW5BTM142TQ2   | 1400ohm (Typ.)    | 2000mA         |   | Kit           | $\geq 1A$ |           |           |    |                    |      | RefFlow            |         |         |         |

△Note • Please read rating and △CAUTION (for storage, operating, rating, soldering, mounting and handling) in this catalog to prevent smoking and/or burning, etc.  
 • This catalog has only typical specifications. Therefore, please approve our product specifications or transact the approval sheet for product specifications before ordering.

Chip Ferrite Bead

Chip EMIFIL®

Chip Common Mode Choke Coil

Block Type EMIFIL®

Microwave Absorber

# PL

## Large Current Common Mode Choke Coil for Automotive Available

### Series Line Up

| Type  | Size<br>in inch (in mm) | Thickness<br>(mm) | Part Number            | Common Mode Impedance<br>(at 10MHz/20°C) | Rated Current | New | Kit | ≥3A  | Hd | U <sub>D</sub> | Z <sub>match</sub> | F <sub>low</sub> | R <sub>eFlow</sub> |
|---|-------------------------|-------------------|------------------------|--|---------------|-----|-----|------|----|----------------|--------------------|------------------|--------------------|
| Large Current<br>Common Mode Choke Coil<br>for Automotive Available | p202<br><br>(12.9x6.6)  | 9.4               | <b>PLT10HH450180PN</b> | 45ohm (Typ.)                             | 18A           |     | Kit | ≥10A |    |                |                    |                  | R <sub>eFlow</sub> |
|   |                         | 9.4               | <b>PLT10HH101150PN</b> | 100ohm (Typ.)                            | 15A           |     | Kit | ≥10A |    |                |                    |                  | R <sub>eFlow</sub> |
|   |                         | 9.4               | <b>PLT10HH401100PN</b> | 400ohm (Typ.)                            | 10A           |     | Kit | ≥10A |    |                |                    |                  | R <sub>eFlow</sub> |
|   |                         | 9.4               | <b>PLT10HH501100PN</b> | 500ohm (Typ.)                            | 10A           |     | Kit | ≥10A |    |                |                    |                  | R <sub>eFlow</sub> |
|   |                         | 9.4               | <b>PLT10HH9016R0PN</b> | 900ohm (Typ.)                            | 6A            |     | Kit | ≥3A  |    |                |                    |                  | R <sub>eFlow</sub> |
|   |                         | 9.4               | <b>PLT10HH1026R0PN</b> | 1000ohm (Typ.)                           | 6A            |     | Kit | ≥3A  |    |                |                    |                  | R <sub>eFlow</sub> |

Chip Ferrite Bead

Chip EMIFIL®

Chip Common Mode Choke Coil

Block Type EMIFIL®

Microwave Absorber

⚠Note • Please read rating and ⚠CAUTION (for storage, operating, rating, soldering, mounting and handling) in this catalog to prevent smoking and/or burning, etc.  
 • This catalog has only typical specifications. Therefore, please approve our product specifications or transact the approval sheet for product specifications before ordering.

# DLW5AH/DLW5BS Series

2014/5036 (inch/mm) **Hi Power** Reflow OK  
 2020/5050 (inch/mm)

5A max., common mode choke coil for power lines.

**DLW5AH**



**■ Dimensions**

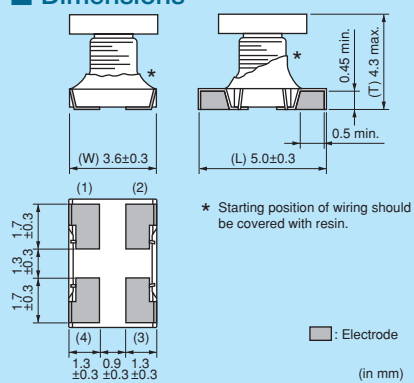

\* Starting position of wiring should be covered with resin.

Legend:  Electrode (in mm)

**■ Equivalent Circuit**

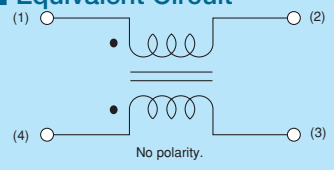

**■ Packaging**

| Code | Packaging                | Minimum Quantity |
|------|--------------------------|------------------|
| L    | 180mm Reel Embossed Tape | 400              |
| K    | 330mm Reel Embossed Tape | 1500             |
| B    | Bulk(Bag)                | 100              |

**DLW5BS**



**■ Dimensions**

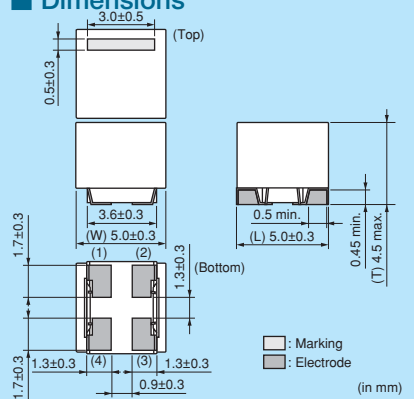

Legend:  Marking  Electrode (in mm)

**■ Equivalent Circuit**

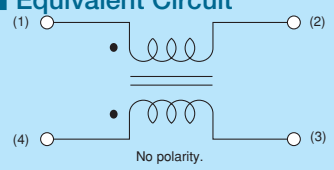

**■ Packaging**

| Code | Packaging                | Minimum Quantity |
|------|--------------------------|------------------|
| L    | 180mm Reel Embossed Tape | 400              |
| K    | 330mm Reel Embossed Tape | 1500             |
| B    | Bulk(Bag)                | 100              |

Refer to pages from p.205 to p.209 for mounting information.

**■ Rated Value** (□: packaging code)

| Part Number    | Common Mode Impedance (at 10MHz/20°C) | Common Mode Impedance (at 100MHz/20°C) | Rated Current | Rated Voltage | Insulation Resistance (min.) | Withstand Voltage | DC Resistance |             |
|----------------|---------------------------------------|--|---------------|---------------|------------------------------|-------------------|---------------|-------------|
| DLW5AHN402SQ2□ | -                                     | 4000ohm (Typ.)                         | 200mA         | 50Vdc         | 10M ohm                      | 125Vdc            | 3.0ohm max.   | Kit         |
| DLW5BSM501TQ2□ | 2800ohm ±40%                          | 500ohm (Typ.)                          | 1000mA        | 50Vdc         | 10M ohm                      | 125Vdc            | 0.23ohm max.  | New Kit ≥1A |
| DLW5BSM601TQ2□ | 1200ohm ±40%                          | 600ohm (Typ.)                          | 1400mA        | 50Vdc         | 10M ohm                      | 125Vdc            | 0.12ohm max.  | New Kit ≥1A |
| DLW5BSM801TQ2□ | 550ohm ±40%                           | 800ohm (Typ.)                          | 2000mA        | 50Vdc         | 10M ohm                      | 125Vdc            | 0.056ohm max. | New Kit ≥1A |
| DLW5BSM191SQ2□ | -                                     | 190ohm (Typ.)                          | 5000mA        | 50Vdc         | 10M ohm                      | 125Vdc            | 0.02ohm max.  | Kit ≥3A     |
| DLW5BSM351SQ2□ | -                                     | 350ohm (Typ.)                          | 2000mA        | 50Vdc         | 10M ohm                      | 125Vdc            | 0.04ohm max.  | Kit ≥1A     |
| DLW5BSM102SQ2□ | -                                     | 1000ohm (Typ.)                         | 1500mA        | 50Vdc         | 10M ohm                      | 125Vdc            | 0.06ohm max.  | Kit ≥1A     |
| DLW5BSM152SQ2□ | -                                     | 1500ohm (Typ.)                         | 1000mA        | 50Vdc         | 10M ohm                      | 125Vdc            | 0.1ohm max.   | Kit ≥1A     |
| DLW5BSM302SQ2□ | -                                     | 3000ohm (Typ.)                         | 500mA         | 50Vdc         | 10M ohm                      | 125Vdc            | 0.3ohm max.   | Kit         |

Operating Temperature Range: -25°C to +85°C (DLW5AH), -40°C to +105°C (DLW5BS\_TQ2), -40°C to +85°C (DLW5BS\_SQ2) Number of Circuit: 1

Continued on the following page. 

△Note • Please read rating and △CAUTION (for storage, operating, rating, soldering, mounting and handling) in this catalog to prevent smoking and/or burning, etc.  
 • This catalog has only typical specifications. Therefore, please approve our product specifications or transact the approval sheet for product specifications before ordering.

**Impedance-Frequency Characteristics**  
**DLW5AH\_SQ2/DLW5BS\_SQ2 Series**

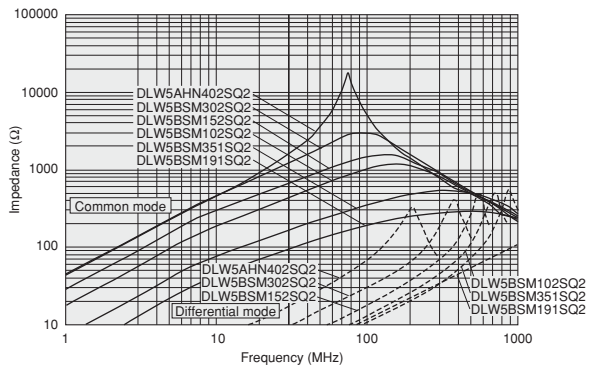

**DLW5BS\_TQ2 Series**

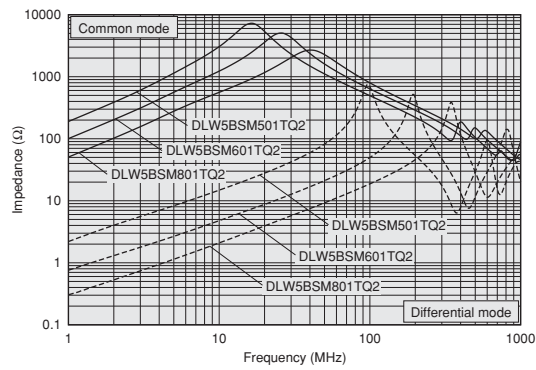

**Notice (Rating)**

In operating temperature exceeding +75°C, derating of current is necessary for DLW5BSM191SQ2. Please apply the derating curve shown in chart according to the operating temperature.

Derating of Rated Current

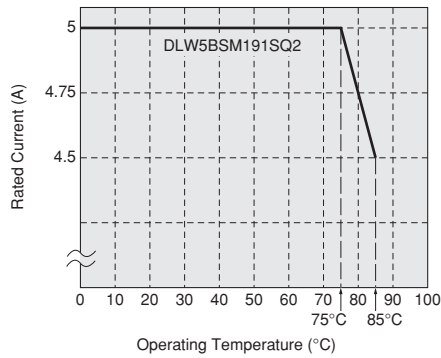

In operating temperature exceeding +65°C, derating of current is necessary for DLW5BS\_TQ2 series. Please apply the derating curve shown in chart according to the operating temperature.

Derating of Rated Current

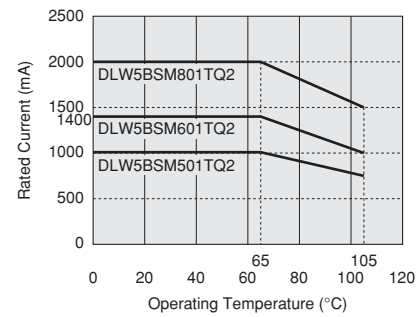

⚠ Note • Please read rating and ⚠ CAUTION (for storage, operating, rating, soldering, mounting and handling) in this catalog to prevent smoking and/or burning, etc.  
 • This catalog has only typical specifications. Therefore, please approve our product specifications or transact the approval sheet for product specifications before ordering.

Chip Ferrite Bead

Chip EMIFIL®

Chip Common Mode Choke Coil  
 Universal Type [Power Lines/Signal Lines]

Block Type EMIFIL®

Microwave Absorber

# DLW5AT/DLW5BT Series 2014/5036 (inch/mm) Hi Power 2020/5050 (inch/mm) Reflow OK

Low profile wire-wound common choke coil for power lines.



**DLW5AT**

**■ Dimensions**

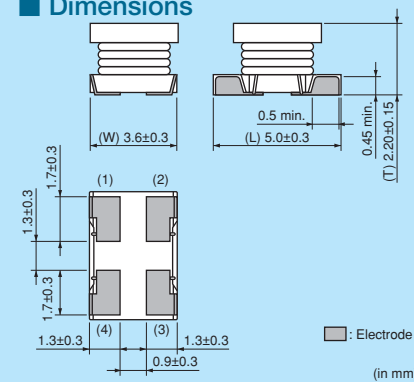

Legend:  Electrode (in mm)

**■ Equivalent Circuit**

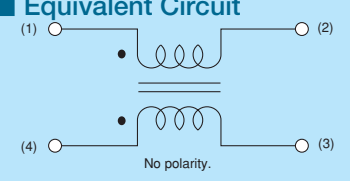

No polarity.

**■ Packaging**

| Code | Packaging                | Minimum Quantity |
|------|--------------------------|------------------|
| L    | 180mm Reel Embossed Tape | 700              |
| K    | 330mm Reel Embossed Tape | 2500             |
| B    | Bulk(Bag)                | 100              |



**DLW5BT**

**■ Dimensions**

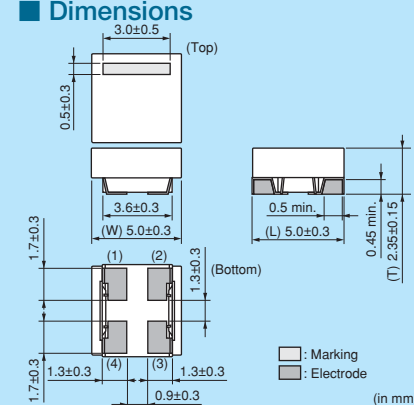

Legend:  Marking  Electrode (in mm)

**■ Equivalent Circuit**

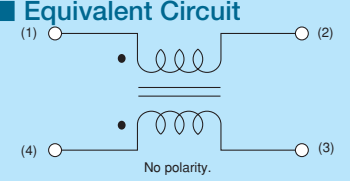

No polarity.

**■ Packaging**

| Code | Packaging                | Minimum Quantity |
|------|--------------------------|------------------|
| L    | 180mm Reel Embossed Tape | 700              |
| K    | 330mm Reel Embossed Tape | 2500             |
| B    | Bulk(Bag)                | 100              |

Refer to pages from p.205 to p.209 for mounting information.

**■ Rated Value** (□: packaging code)

| Part Number    | Common Mode Impedance (at 100MHz/20°C) | Rated Current | Rated Voltage | Insulation Resistance (min.) | Withstand Voltage | DC Resistance |         |
|----------------|--|---------------|---------------|------------------------------|-------------------|---------------|---------|
| DLW5ATN111SQ2□ | 110ohm (Typ.)                          | 5000mA        | 50Vdc         | 10M ohm                      | 125Vdc            | 0.020ohm max. | Kit ≥3A |
| DLW5ATN401SQ2□ | 400ohm (Typ.)                          | 2000mA        | 50Vdc         | 10M ohm                      | 125Vdc            | 0.034ohm max. | Kit ≥1A |
| DLW5ATN501SQ2□ | 500ohm (Typ.)                          | 1500mA        | 50Vdc         | 10M ohm                      | 125Vdc            | 0.056ohm max. | Kit ≥1A |
| DLW5ATN851SQ2□ | 850ohm (Typ.)                          | 1500mA        | 50Vdc         | 10M ohm                      | 125Vdc            | 0.073ohm max. | Kit ≥1A |
| DLW5ATN272SQ2□ | 2700ohm (Typ.)                         | 1000mA        | 50Vdc         | 10M ohm                      | 125Vdc            | 0.12ohm max.  | Kit ≥1A |
| DLW5BTM101SQ2□ | 100ohm (Typ.)                          | 6000mA        | 50Vdc         | 10M ohm                      | 125Vdc            | 0.013ohm max. | Kit ≥3A |
| DLW5BTM251SQ2□ | 250ohm (Typ.)                          | 5000mA        | 50Vdc         | 10M ohm                      | 125Vdc            | 0.020ohm max. | Kit ≥3A |
| DLW5BTM501SQ2□ | 500ohm (Typ.)                          | 4000mA        | 50Vdc         | 10M ohm                      | 125Vdc            | 0.027ohm max. | Kit ≥3A |
| DLW5BTM102SQ2□ | 1000ohm (Typ.)                         | 2000mA        | 50Vdc         | 10M ohm                      | 125Vdc            | 0.034ohm max. | Kit ≥1A |
| DLW5BTM142SQ2□ | 1400ohm (Typ.)                         | 1500mA        | 50Vdc         | 10M ohm                      | 125Vdc            | 0.056ohm max. | Kit ≥1A |

Operating Temperature Range: -40°C to +85°C Number of Circuit: 1

Continued on the following page.

△Note • Please read rating and △CAUTION (for storage, operating, rating, soldering, mounting and handling) in this catalog to prevent smoking and/or burning, etc.  
 • This catalog has only typical specifications. Therefore, please approve our product specifications or transact the approval sheet for product specifications before ordering.

**Impedance-Frequency Characteristics**  
**DLW5AT Series**

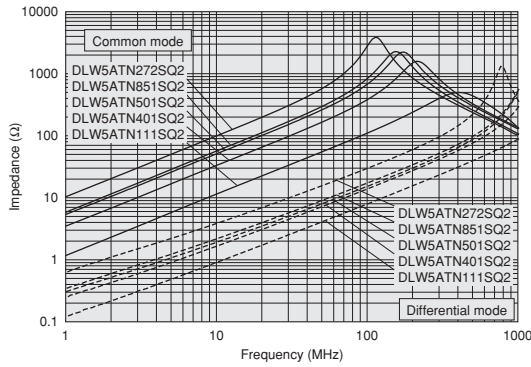

**DLW5BT Series**

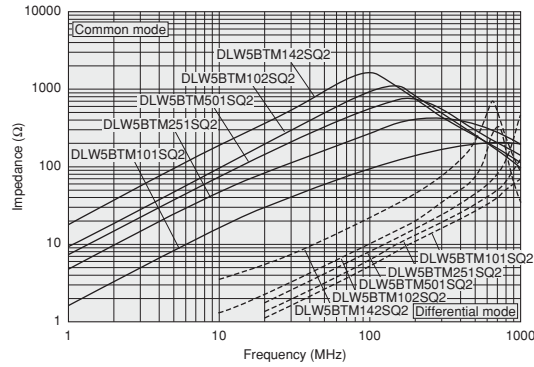

**Notice (Rating)**

In operating temperature exceeding +60°C, derating of current is necessary for DLW5AT series. Please apply the derating curve shown in chart according to the operating temperature.

Derating of Rated Current

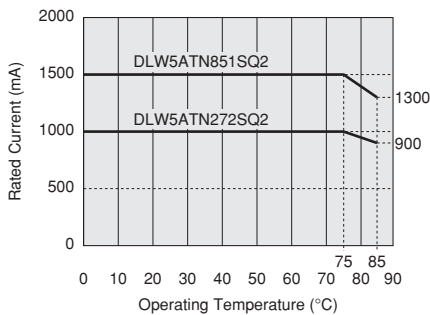
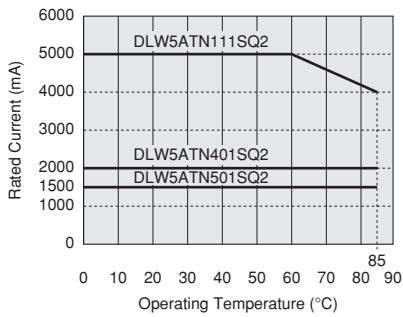

In operating temperature exceeding +60°C, derating of current is necessary for the following part name of DLW5BT series. Please apply the derating curve shown in chart according to the operating temperature.

Derating of Rated Current

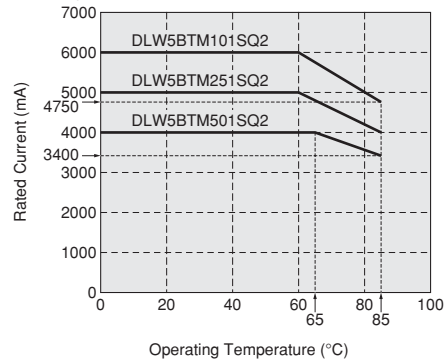

△Note • Please read rating and △CAUTION (for storage, operating, rating, soldering, mounting and handling) in this catalog to prevent smoking and/or burning, etc.  
• This catalog has only typical specifications. Therefore, please approve our product specifications or transact the approval sheet for product specifications before ordering.

Chip Ferrite Bead  
Chip EMIFIL®  
Chip Common Mode Choke Coil  
Universal Type [Power Lines/Signal Lines]  
Block Type EMIFIL®  
Microwave Absorber

# DLW5AT/DLW5BT Series (105degreeC available type)



Low profile wire-wound common choke coil for power lines. (105degreeC available type)

DLW5AT\_MQ2



**■ Dimensions**

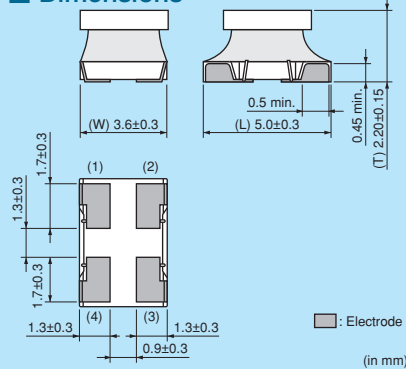

**■ Equivalent Circuit**

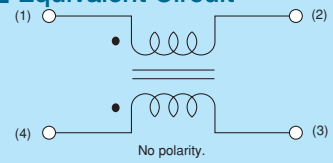

**■ Packaging**

| Code | Packaging                | Minimum Quantity |
|------|--------------------------|------------------|
| L    | 180mm Reel Embossed Tape | 700              |
| K    | 330mm Reel Embossed Tape | 2500             |
| B    | Bulk(Bag)                | 100              |

DLW5AT\_TQ2



**■ Dimensions**

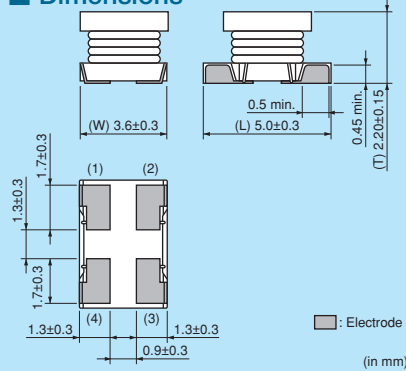

**■ Equivalent Circuit**

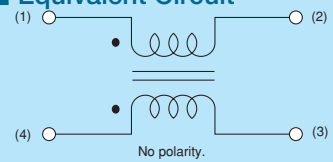

**■ Packaging**

| Code | Packaging                | Minimum Quantity |
|------|--------------------------|------------------|
| L    | 180mm Reel Embossed Tape | 700              |
| K    | 330mm Reel Embossed Tape | 2500             |
| B    | Bulk(Bag)                | 100              |

DLW5BT\_TQ2



**■ Dimensions**

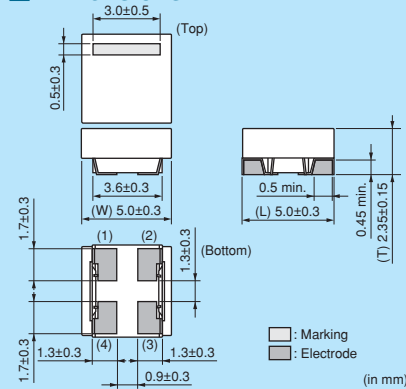

**■ Equivalent Circuit**

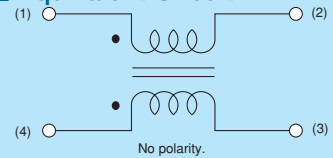

**■ Packaging**

| Code | Packaging                | Minimum Quantity |
|------|--------------------------|------------------|
| L    | 180mm Reel Embossed Tape | 700              |
| K    | 330mm Reel Embossed Tape | 2500             |
| B    | Bulk(Bag)                | 100              |

Refer to pages from p.205 to p.209 for mounting information.

Continued on the following page.

△Note • Please read rating and △CAUTION (for storage, operating, rating, soldering, mounting and handling) in this catalog to prevent smoking and/or burning, etc.  
 • This catalog has only typical specifications. Therefore, please approve our product specifications or transact the approval sheet for product specifications before ordering.

Rated Value (□: packaging code)

| Part Number    | Common Mode Impedance (at 100MHz/20°C) | Rated Current | Rated Voltage | Insulation Resistance (min.) | Withstand Voltage | DC Resistance |                         |
|----------------|--|---------------|---------------|------------------------------|-------------------|---------------|-------------------------|
| DLW5ATN500MQ2□ | 50ohm (Typ.)                           | 6000mA        | 50Vdc         | 10M ohm                      | 125Vdc            | 0.013ohm max. | Kit ≥3A Flow ReFlow     |
| DLW5ATN151MQ2□ | 150ohm (Typ.)                          | 5000mA        | 50Vdc         | 10M ohm                      | 125Vdc            | 0.020ohm max. | Kit ≥3A Flow ReFlow     |
| DLW5ATN331MQ2□ | 330ohm (Typ.)                          | 4000mA        | 50Vdc         | 10M ohm                      | 125Vdc            | 0.027ohm max. | Kit ≥3A Flow ReFlow     |
| DLW5ATN501MQ2□ | 500ohm (Typ.)                          | 2500mA        | 50Vdc         | 10M ohm                      | 125Vdc            | 0.034ohm max. | New Kit ≥1A Flow ReFlow |
| DLW5ATN112MQ2□ | 1100ohm (Typ.)                         | 2000mA        | 50Vdc         | 10M ohm                      | 125Vdc            | 0.056ohm max. | Kit ≥1A Flow ReFlow     |
| DLW5ATN111TQ2□ | 110ohm (Typ.)                          | 5000mA        | 50Vdc         | 10M ohm                      | 125Vdc            | 0.020ohm max. | Kit ≥3A ReFlow          |
| DLW5ATN231TQ2□ | 230ohm (Typ.)                          | 4000mA        | 50Vdc         | 10M ohm                      | 125Vdc            | 0.027ohm max. | Kit ≥3A ReFlow          |
| DLW5ATN401TQ2□ | 400ohm (Typ.)                          | 2500mA        | 50Vdc         | 10M ohm                      | 125Vdc            | 0.034ohm max. | New Kit ≥1A ReFlow      |
| DLW5ATN501TQ2□ | 500ohm (Typ.)                          | 2000mA        | 50Vdc         | 10M ohm                      | 125Vdc            | 0.056ohm max. | Kit ≥1A ReFlow          |
| DLW5BTM101TQ2□ | 100ohm (Typ.)                          | 6000mA        | 50Vdc         | 10M ohm                      | 125Vdc            | 0.013ohm max. | Kit ≥3A ReFlow          |
| DLW5BTM251TQ2□ | 250ohm (Typ.)                          | 5000mA        | 50Vdc         | 10M ohm                      | 125Vdc            | 0.020ohm max. | Kit ≥3A ReFlow          |
| DLW5BTM501TQ2□ | 500ohm (Typ.)                          | 4000mA        | 50Vdc         | 10M ohm                      | 125Vdc            | 0.027ohm max. | Kit ≥3A ReFlow          |
| DLW5BTM102TQ2□ | 1000ohm (Typ.)                         | 2500mA        | 50Vdc         | 10M ohm                      | 125Vdc            | 0.034ohm max. | New Kit ≥1A ReFlow      |
| DLW5BTM142TQ2□ | 1400ohm (Typ.)                         | 2000mA        | 50Vdc         | 10M ohm                      | 125Vdc            | 0.056ohm max. | Kit ≥1A ReFlow          |

Operating Temperature Range: -40°C to +105°C Number of Circuit: 1

Impedance-Frequency Characteristics  
DLW5AT\_MQ2 Series

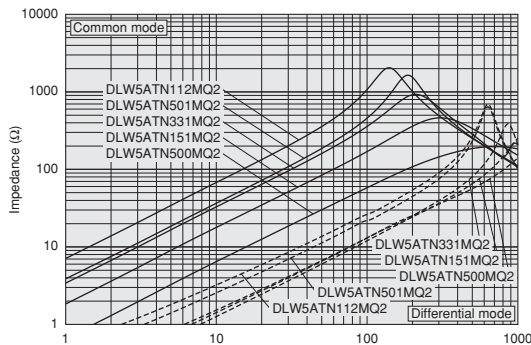

DLW5AT\_TQ2 Series

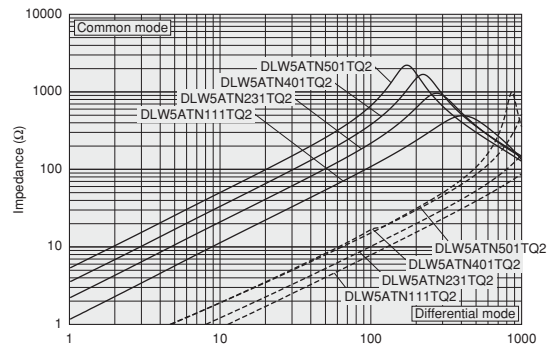

DLW5BT\_TQ2 Series

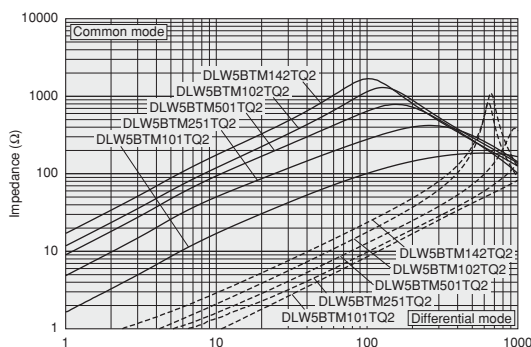

△Note • Please read rating and △CAUTION (for storage, operating, rating, soldering, mounting and handling) in this catalog to prevent smoking and/or burning, etc.  
• This catalog has only typical specifications. Therefore, please approve our product specifications or transact the approval sheet for product specifications before ordering.

Chip Ferrite Bead

Chip EMIFIL®

Chip Common Mode Choke Coil  
Universal Type [Power Lines/Signal Lines]

Block Type EMIFIL®

Microwave Absorber



**Notice (Rating)**

In operating temperature exceeding +85°C, derating of current is necessary for DLW5AT series (105 degree C available type). Please apply the derating curve shown in chart according to the operating temperature.

In operating temperature exceeding +85°C, derating of current is necessary for DLW5AT series (105 degree C available type). Please apply the derating curve shown in chart according to the operating temperature.

Derating of Rated Current

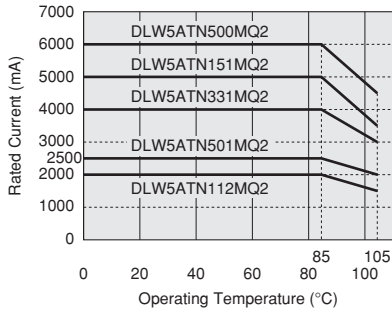

Derating of Rated Current

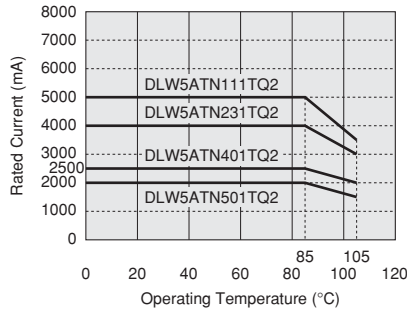

In operating temperature exceeding +85°C, derating of current is necessary for DLW5BT series (105 degree C available type). Please apply the derating curve shown in chart according to the operating temperature.

Derating of Rated Current

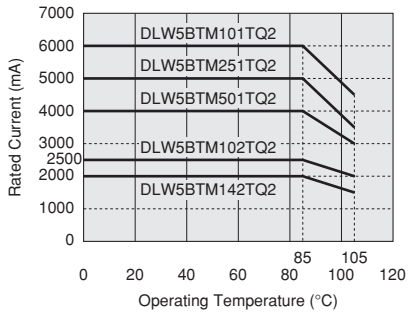

⚠Note • Please read rating and ⚠CAUTION (for storage, operating, rating, soldering, mounting and handling) in this catalog to prevent smoking and/or burning, etc.  
• This catalog has only typical specifications. Therefore, please approve our product specifications or transact the approval sheet for product specifications before ordering.

# DLM11G Series 0504/1210 (inch/mm)



Audio line common choke also effective to differential mode.

### ■ Dimensions

(in mm)

### ■ Equivalent Circuit

No polarity.

### ■ Packaging

| Code | Packaging             | Minimum Quantity |
|------|-----------------------|------------------|
| D    | 180mm Reel Paper Tape | 10000            |
| B    | Bulk(Bag)             | 1000             |

Refer to pages from p.205 to p.209 for mounting information.

### ■ Rated Value (□: packaging code)

| Part Number    | Common Mode Impedance (at 100MHz/20°C) | Rated Current | Rated Voltage | Insulation Resistance (min.) | Withstand Voltage | DC Resistance | Operating Temperature Range |
|----------------|--|---------------|---------------|------------------------------|-------------------|---------------|-----------------------------|
| DLM11GN601SD2□ | 600ohm ±25%                            | 100mA         | 5Vdc          | 100M ohm                     | 25Vdc             | 0.8ohm max.   | -40°C to +85°C              |

Number of Circuit: 1

### ■ Impedance-Frequency Characteristics

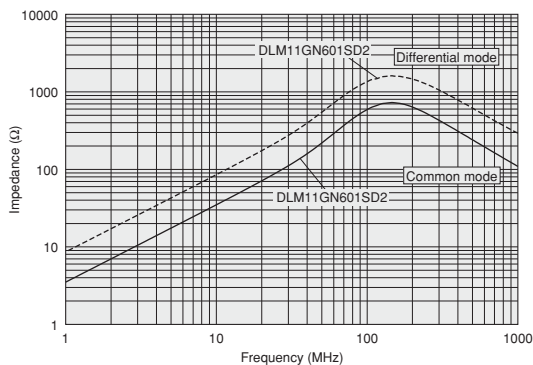

△Note • Please read rating and △CAUTION (for storage, operating, rating, soldering, mounting and handling) in this catalog to prevent smoking and/or burning, etc.  
 • This catalog has only typical specifications. Therefore, please approve our product specifications or transact the approval sheet for product specifications before ordering.

Chip Ferrite Bead

Chip EMIFIL®

Chip Common Mode Choke Coil  
Signal Lines Type

Block Type EMIFIL®

Microwave Absorber

# DLM11S Series 0504/1210 (inch/mm)



## 0504 size multilayer type chip common mode choke coil.

### ■ Dimensions

(in mm)

### ■ Equivalent Circuit

No polarity.

### ■ Packaging

| Code | Packaging                | Minimum Quantity |
|------|--------------------------|------------------|
| L    | 180mm Reel Embossed Tape | 4000             |
| B    | Bulk(Bag)                | 500              |

Refer to pages from p.205 to p.209 for mounting information.

### ■ Rated Value (□: packaging code)

| Part Number    | Common Mode Impedance (at 100MHz/20°C) | Rated Current | Rated Voltage | Insulation Resistance (min.) | Withstand Voltage | DC Resistance |                  |
|----------------|--|---------------|---------------|------------------------------|-------------------|---------------|------------------|
| DLM11SN450HY2□ | 45ohm ±25%                             | 100mA         | 5Vdc          | 100M ohm                     | 12.5Vdc           | 0.7ohm±25%    | Kit HD IMP match |
| DLM11SN900HY2□ | 90ohm ±25%                             | 100mA         | 5Vdc          | 100M ohm                     | 12.5Vdc           | 1.1ohm±25%    | Kit HD IMP match |

Operating Temperature Range: -40°C to +85°C Number of Circuit: 1

### ■ Impedance-Frequency Characteristics

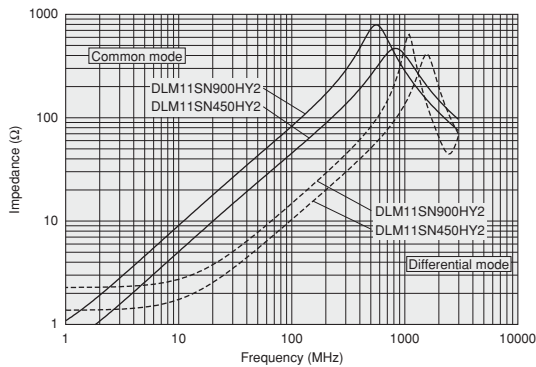

### ■ Differential Mode Transmission Characteristics (Typ.)

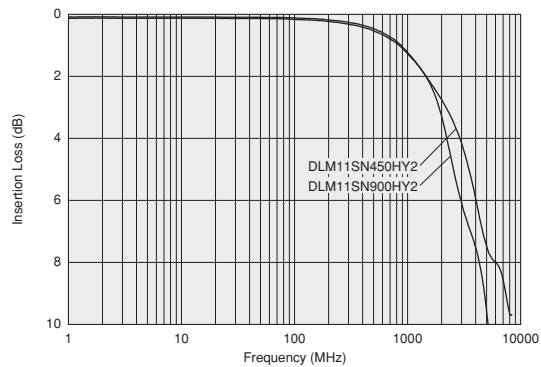

⚠Note • Please read rating and ⚠CAUTION (for storage, operating, rating, soldering, mounting and handling) in this catalog to prevent smoking and/or burning, etc.  
 • This catalog has only typical specifications. Therefore, please approve our product specifications or transact the approval sheet for product specifications before ordering.

# DLPOQS Series 025020/0605 (inch/mm)



025020 size, very small chip common mode choke coil, Cut-off frequency 8GHz max. Some of them are ready for Display port or SATA.

### ■ Dimensions

(in mm)

### ■ Equivalent Circuit

No polarity.

### ■ Packaging

| Code | Packaging             | Minimum Quantity |
|------|-----------------------|------------------|
| D    | 180mm Reel Paper Tape | 15000            |
| B    | Bulk(Bag)             | 500              |

Refer to pages from p.205 to p.209 for mounting information.

### ■ Rated Value (□: packaging code)

| Part Number    | Common Mode Impedance (at 100MHz/20°C) | Rated Current | Rated Voltage | Insulation Resistance (min.) | Withstand Voltage | DC Resistance |        |
|----------------|--|---------------|---------------|------------------------------|-------------------|---------------|--------|
| DLPOQSN600HL2□ | 60ohm ±25%                             | 50mA          | 5Vdc          | 100M ohm                     | 12.5Vdc           | 3.8ohm±25%    | Kit HD |
| DLPOQSA070HL2□ | 7ohm ±2ohm                             | 100mA         | 5Vdc          | 100M ohm                     | 12.5Vdc           | 0.7ohm±25%    | Kit UD |
| DLPOQSA150HL2□ | 15ohm ±5ohm                            | 100mA         | 5Vdc          | 100M ohm                     | 12.5Vdc           | 0.8ohm±25%    | Kit UD |
| DLPOQSA350HL2□ | 35ohm ±10ohm                           | 100mA         | 5Vdc          | 100M ohm                     | 12.5Vdc           | 2.2ohm±25%    | Kit UD |

Operating Temperature Range: -40°C to +85°C Number of Circuit: 1

HD: for high speed differential signal lines

UD: for ultra high speed differential signal lines

### ■ Impedance-Frequency Characteristics DLPOQSN Series

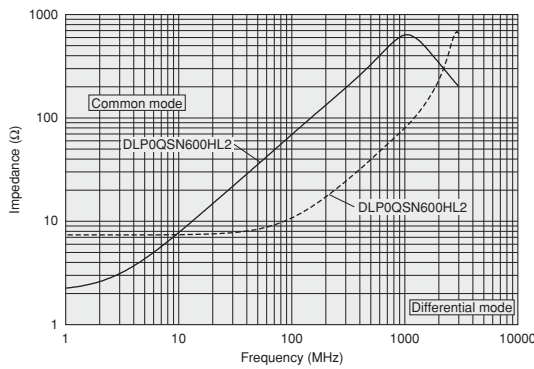

### DLPOQSA Series

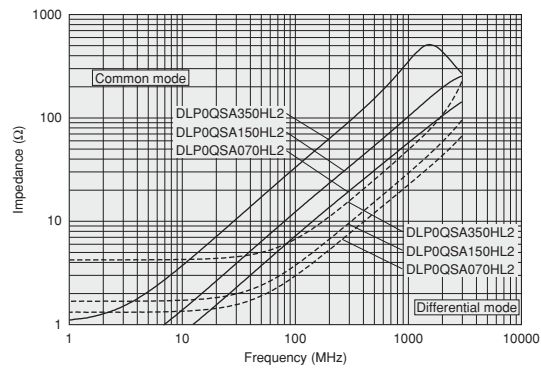

### ■ Differential Mode Transmission Characteristics (Typ.) DLPOQSN Series

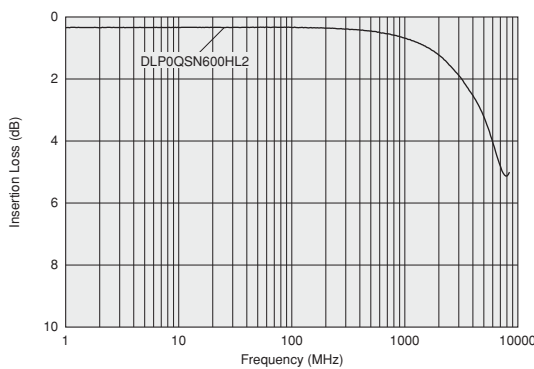

### DLPOQSA Series

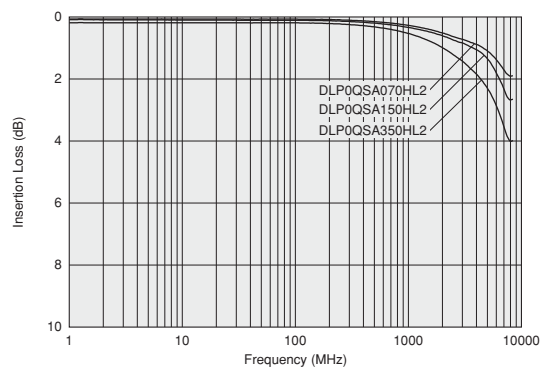

△Note • Please read rating and △CAUTION (for storage, operating, rating, soldering, mounting and handling) in this catalog to prevent smoking and/or burning, etc.  
• This catalog has only typical specifications. Therefore, please approve our product specifications or transact the approval sheet for product specifications before ordering.

Chip Ferrite Bead

Chip EMIFIL®

Chip Common Mode Choke Coil  
Signal Lines Type

Block Type EMIFIL®

Microwave Absorber

# DLP0NS Series 03025/0806 (inch/mm)



03025 size, very small chip common mode choke coil, Cut-off frequency 8GHz max. Some of them are ready for mipi, Display port or SATA.

### ■ Dimensions

(in mm)

### ■ Equivalent Circuit

No polarity.

### ■ Packaging

| Code | Packaging                | Minimum Quantity |
|------|--------------------------|------------------|
| L    | 180mm Reel Embossed Tape | 10000            |
| B    | Bulk(Bag)                | 500              |

Refer to pages from p.205 to p.209 for mounting information.

### ■ Rated Value (□: packaging code)

| Part Number    | Common Mode Impedance (at 100MHz/20°C) | Rated Current | Rated Voltage | Insulation Resistance (min.) | Withstand Voltage | DC Resistance |        |
|----------------|--|---------------|---------------|------------------------------|-------------------|---------------|--------|
| DLP0NSC280HL2□ | 28ohm ±20%                             | 100mA         | 5Vdc          | 100M ohm                     | 12.5Vdc           | 1.3ohm±25%    | Kit HD |
| DLP0NSN350HL2□ | 35ohm ±10ohm                           | 100mA         | 5Vdc          | 100M ohm                     | 12.5Vdc           | 1.2ohm±25%    | Kit HD |
| DLP0NSN670HL2□ | 67ohm ±20%                             | 110mA         | 5Vdc          | 100M ohm                     | 12.5Vdc           | 2.4ohm±25%    | Kit HD |
| DLP0NSN900HL2□ | 90ohm ±20%                             | 100mA         | 5Vdc          | 100M ohm                     | 12.5Vdc           | 3.0ohm±25%    | Kit HD |
| DLP0NSN121HL2□ | 120ohm ±20%                            | 90mA          | 5Vdc          | 100M ohm                     | 12.5Vdc           | 3.8ohm±25%    | Kit HD |
| DLP0NSA070HL2□ | 7ohm ±2ohm                             | 100mA         | 5Vdc          | 100M ohm                     | 12.5Vdc           | 0.6ohm±25%    | Kit    |
| DLP0NSA150HL2□ | 15ohm ±5ohm                            | 100mA         | 5Vdc          | 100M ohm                     | 12.5Vdc           | 0.95ohm±25%   | Kit    |

Operating Temperature Range: -40°C to +85°C Number of Circuit: 1

HD: for high speed differential signal lines

UD: for ultra high speed differential signal lines

### ■ Impedance-Frequency Characteristics

#### DLP0NSC/DLP0NSN Series

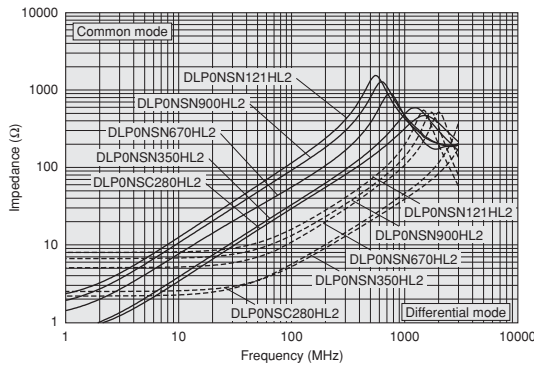

#### DLP0NSA Series

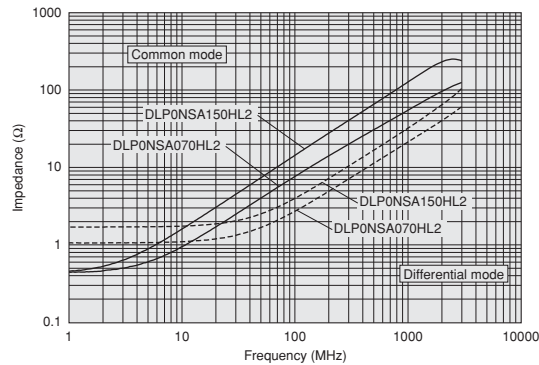

Continued on the following page.

△Note • Please read rating and △CAUTION (for storage, operating, rating, soldering, mounting and handling) in this catalog to prevent smoking and/or burning, etc.  
 • This catalog has only typical specifications. Therefore, please approve our product specifications or transact the approval sheet for product specifications before ordering.

■ Differential Mode Transmission Characteristics (Typ.)

DLP0NSC/DLP0NSN Series

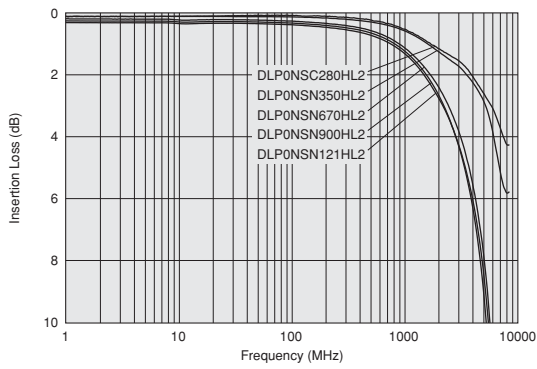

DLP0NSA Series

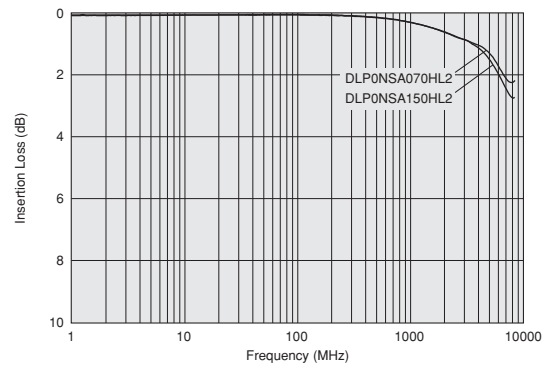

Chip Ferrite Bead

Chip EMIFIL®

Chip Common Mode Choke Coil  
 Signal Lines Type

Block Type EMIFIL®

Microwave Absorber

△Note • Please read rating and △CAUTION (for storage, operating, rating, soldering, mounting and handling) in this catalog to prevent smoking and/or burning, etc.  
 • This catalog has only typical specifications. Therefore, please approve our product specifications or transact the approval sheet for product specifications before ordering.

# DLP11S/DLP11R/DLP11T Series 0504/1210 (inch/mm)



8GHz cut-off frequency (for HDMI/USB3.0) is available.

### ■ Dimensions

| Part Number | T        |
|-------------|----------|
| DLP11S      | 0.82±0.1 |
| DLP11R      | 0.5±0.1  |
| DLP11T      | 0.3±0.05 |

Legend:  Electrode (in mm)

### ■ Equivalent Circuit

No polarity.

### ■ Packaging

| Code | Packaging                | Minimum Quantity  |
|------|--------------------------|-------------------|
| L    | 180mm Reel Embossed Tape | 3000 (DLP11S)     |
|      |                          | 4000 (DLP11RN/RB) |
|      |                          | 5000 (DLP11T)     |
| B    | Bulk(Bag)                | 500               |

Refer to pages from p.205 to p.209 for mounting information.

## ■ Rated Value (□: packaging code)

| Part Number    | Common Mode Impedance (at 100MHz/20°C) | Rated Current | Rated Voltage | Insulation Resistance (min.) | Withstand Voltage | DC Resistance | Kit | HD | UD | Imp. Match |
|----------------|--|---------------|---------------|------------------------------|-------------------|---------------|-----|----|----|------------|
| DLP11SN670SL2□ | 67ohm ±20%                             | 180mA         | 5Vdc          | 100M ohm                     | 12.5Vdc           | 1.3ohm±25%    | Kit | HD |    |            |
| DLP11SN121SL2□ | 120ohm ±20%                            | 140mA         | 5Vdc          | 100M ohm                     | 12.5Vdc           | 2.0ohm±25%    | Kit | HD |    |            |
| DLP11SN161SL2□ | 160ohm ±20%                            | 120mA         | 5Vdc          | 100M ohm                     | 12.5Vdc           | 2.7ohm±25%    | Kit | HD |    |            |
| DLP11SN900HL2□ | 90ohm ±20%                             | 150mA         | 5Vdc          | 100M ohm                     | 12.5Vdc           | 1.5ohm±25%    | Kit | HD |    | Imp. Match |
| DLP11SN201HL2□ | 200ohm ±20%                            | 110mA         | 5Vdc          | 100M ohm                     | 12.5Vdc           | 3.1ohm±25%    | Kit | HD |    | Imp. Match |
| DLP11SN241HL2□ | 240ohm ±20%                            | 100mA         | 5Vdc          | 100M ohm                     | 12.5Vdc           | 3.5ohm±25%    | Kit | HD |    | Imp. Match |
| DLP11SN281HL2□ | 280ohm ±20%                            | 90mA          | 5Vdc          | 100M ohm                     | 12.5Vdc           | 4.2ohm±25%    | Kit | HD |    | Imp. Match |
| DLP11SN331HL2□ | 330ohm ±20%                            | 80mA          | 5Vdc          | 100M ohm                     | 12.5Vdc           | 4.9ohm±25%    | Kit | HD |    | Imp. Match |
| DLP11SA350HL2□ | 35ohm ±20%                             | 170mA         | 5Vdc          | 100M ohm                     | 12.5Vdc           | 0.9ohm±25%    | Kit |    | UD | Imp. Match |
| DLP11SA670HL2□ | 67ohm ±20%                             | 150mA         | 5Vdc          | 100M ohm                     | 12.5Vdc           | 1.2ohm±25%    | Kit |    | UD | Imp. Match |
| DLP11SA900HL2□ | 90ohm ±20%                             | 150mA         | 5Vdc          | 100M ohm                     | 12.5Vdc           | 1.4ohm±25%    | Kit |    | UD | Imp. Match |

Operating Temperature Range: -40°C to +85°C Number of Circuit: 1

HD: for high speed differential signal lines

UD: for ultra high speed differential signal lines

## ■ Impedance-Frequency Characteristics DLP11SN Series

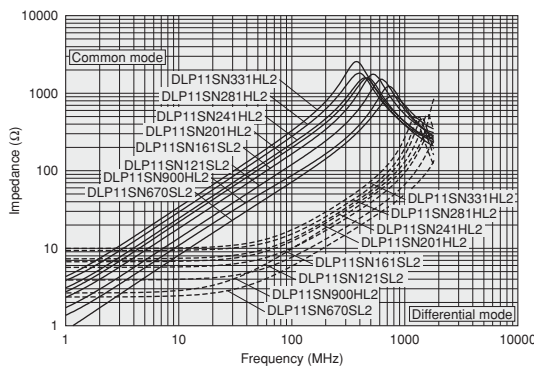

## DLP11SA Series

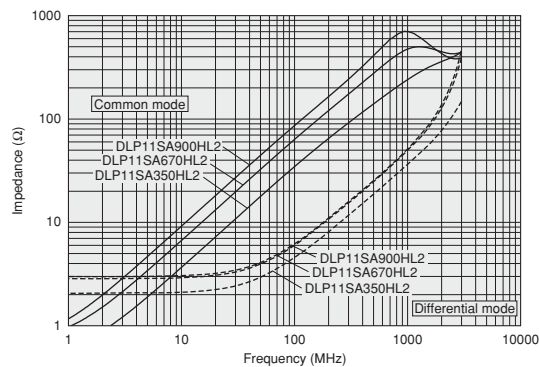

Continued on the following page.

△Note • Please read rating and △CAUTION (for storage, operating, rating, soldering, mounting and handling) in this catalog to prevent smoking and/or burning, etc.  
• This catalog has only typical specifications. Therefore, please approve our product specifications or transact the approval sheet for product specifications before ordering.

**Differential Mode Transmission Characteristics (Typ.)**

DLP11SN Series

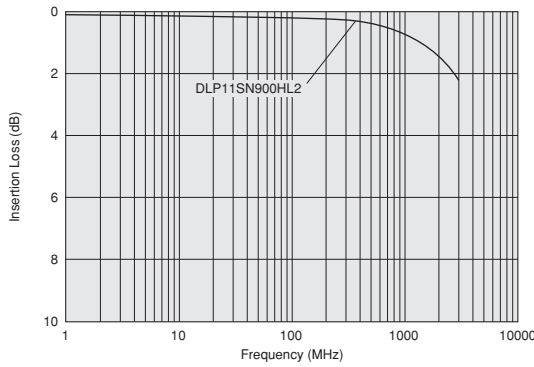

DLP11SA Series

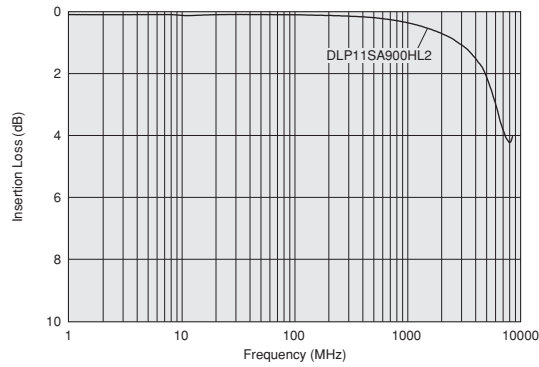

**Rated Value (□: packaging code)**

| Part Number    | Common Mode Impedance (at 100MHz/20°C) | Rated Current | Rated Voltage | Insulation Resistance (min.) | Withstand Voltage | DC Resistance |        |
|----------------|--|---------------|---------------|------------------------------|-------------------|---------------|--------|
| DLP11RN450UL2□ | 45ohm ±25%                             | 100mA         | 5Vdc          | 100M ohm                     | 12.5Vdc           | 0.8ohm±25%    | Kit HD |
| DLP11RB150UL2□ | 15ohm ±5ohm                            | 100mA         | 5Vdc          | 100M ohm                     | 12.5Vdc           | 0.8ohm±25%    | Kit UD |
| DLP11RB400UL2□ | 40ohm ±10ohm                           | 100mA         | 5Vdc          | 100M ohm                     | 12.5Vdc           | 1.3ohm±25%    | Kit UD |

Operating Temperature Range: -40°C to +85°C Number of Circuit: 1  
 Differential mode to common mode conversion characteristic (Scd21) at 2.5GHz  
 DLP11RB: -40dB  
 Impedance Characteristics between signal lines Z0 (TDR at 50ps)  
 DLP11RB: 90ohm±15ohm

**Impedance-Frequency Characteristics**

DLP11RN Series

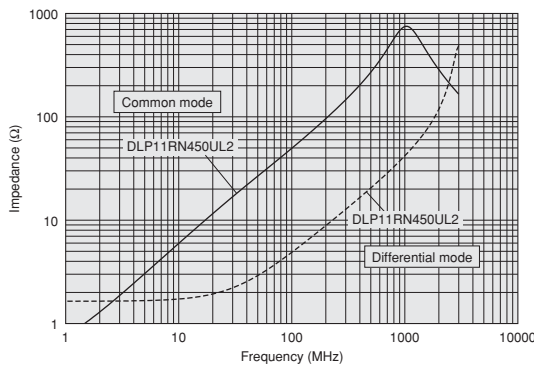

DLP11RB Series

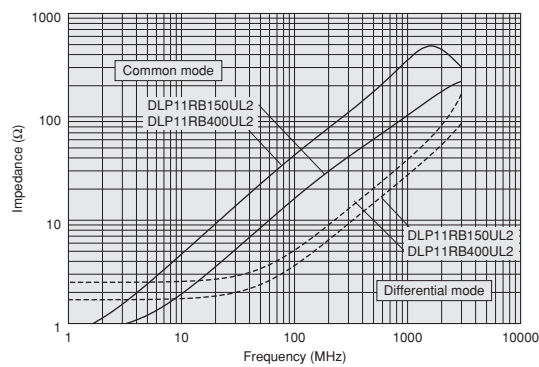

**Differential Mode Transmission Characteristics (Typ.)**

DLP11RN Series

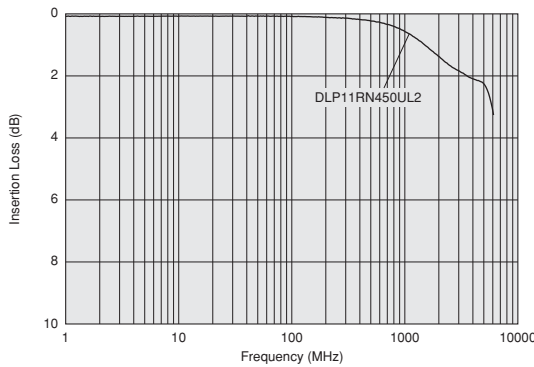

DLP11RB Series

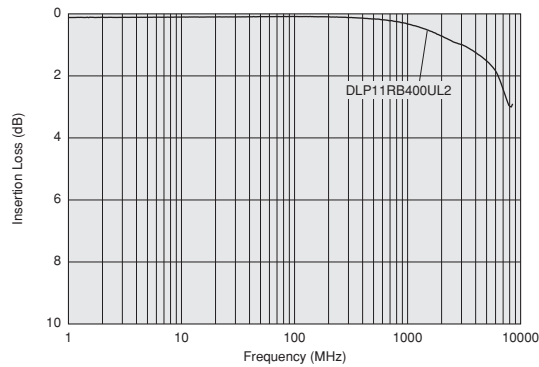

Continued on the following page.

△Note • Please read rating and △CAUTION (for storage, operating, rating, soldering, mounting and handling) in this catalog to prevent smoking and/or burning, etc.  
 • This catalog has only typical specifications. Therefore, please approve our product specifications or transact the approval sheet for product specifications before ordering.

Chip Ferrite Bead  
Chip EMIFIL®  
Chip Common Mode Choke Coil Signal Lines Type  
Block Type EMIFIL®  
Microwave Absorber



■ Rated Value (□: packaging code)

| Part Number    | Common Mode Impedance<br>(at 100MHz/20°C) | Rated Current | Rated Voltage | Insulation Resistance<br>(min.) | Withstand Voltage | DC Resistance |        |
|----------------|---|---------------|---------------|---------------------------------|-------------------|---------------|--------|
| DLP11TB800UL2□ | 80ohm ±25%                                | 100mA         | 5Vdc          | 100M ohm                        | 12.5Vdc           | 1.5ohm±25%    | Kit UD |

Operating Temperature Range: -40°C to +85°C Number of Circuit: 1  
 Differential mode to common mode conversion characteristic (Scd21) at 2.5GHz  
 DLP11TB: -40dB  
 Impedance Characteristics between signal lines Z0 (TDR at 50ps)  
 DLP11TB: 90ohm±15ohm

HD: for high speed differential signal lines UD: for ultra high speed differential signal lines

■ Impedance-Frequency Characteristics  
 DLP11TB Series

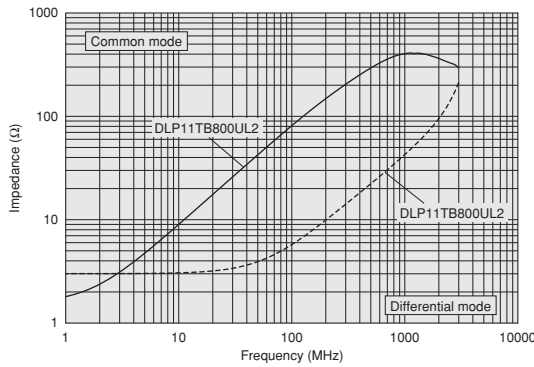

■ Differential Mode Transmission Characteristics (Typ.)  
 DLP11TB Series

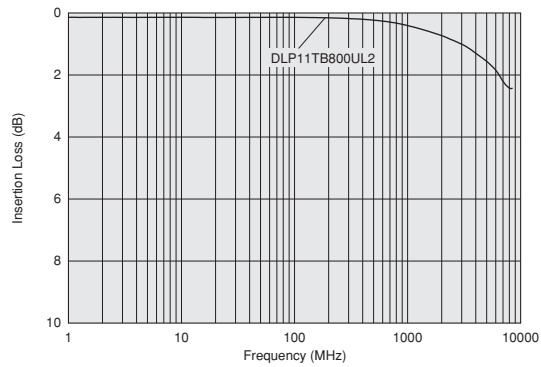

⚠Note • Please read rating and ⚠CAUTION (for storage, operating, rating, soldering, mounting and handling) in this catalog to prevent smoking and/or burning, etc.  
 • This catalog has only typical specifications. Therefore, please approve our product specifications or transact the approval sheet for product specifications before ordering.

# DLP31S Series 1206/3216 (inch/mm)



1206 size film type chip common mode choke coil.



### ■ Dimensions

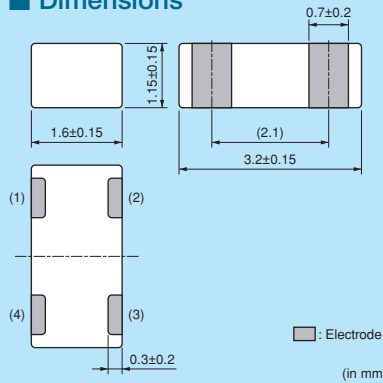

### ■ Equivalent Circuit

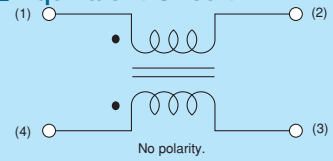

### ■ Packaging

| Code | Packaging                | Minimum Quantity |
|------|--------------------------|------------------|
| L    | 180mm Reel Embossed Tape | 3000             |
| B    | Bulk(Bag)                | 500              |

Refer to pages from p.205 to p.209 for mounting information.

### ■ Rated Value (□: packaging code)

| Part Number    | Common Mode Impedance (at 100MHz/20°C) | Rated Current | Rated Voltage | Insulation Resistance (min.) | Withstand Voltage | DC Resistance |           |
|----------------|--|---------------|---------------|------------------------------|-------------------|---------------|-----------|
| DLP31SN121ML2□ | 120ohm ±20%                            | 100mA         | 16Vdc         | 100M ohm                     | 40Vdc             | 2.0ohm max.   | <b>HD</b> |
| DLP31SN221ML2□ | 220ohm ±20%                            | 100mA         | 16Vdc         | 100M ohm                     | 40Vdc             | 2.5ohm max.   | <b>HD</b> |
| DLP31SN551ML2□ | 550ohm ±20%                            | 100mA         | 16Vdc         | 100M ohm                     | 40Vdc             | 3.6ohm max.   | <b>HD</b> |

Operating Temperature Range: -40°C to +85°C Number of Circuit: 1

HD: for high speed differential signal lines UD: for ultra high speed differential signal lines

### ■ Impedance-Frequency Characteristics

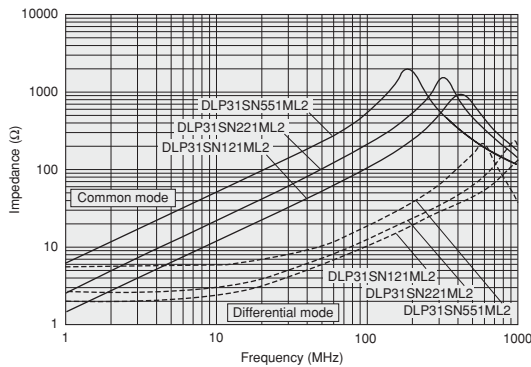

△Note • Please read rating and △CAUTION (for storage, operating, rating, soldering, mounting and handling) in this catalog to prevent smoking and/or burning, etc.  
• This catalog has only typical specifications. Therefore, please approve our product specifications or transact the approval sheet for product specifications before ordering.

Chip Ferrite Bead  
Chip EMIFIL®  
Chip Common Mode Choke Coil  
Signal Lines Type  
Block Type EMIFIL®  
Microwave Absorber

# DLP1ND Series 05025/1506 (inch/mm)



2 circuits in 05025 size, adapt to HDMI line.

### ■ Dimensions

Legend:  Electrode (in mm)

### ■ Equivalent Circuit

### ■ Packaging

| Code | Packaging                | Minimum Quantity |
|------|--------------------------|------------------|
| L    | 180mm Reel Embossed Tape | 5000             |
| B    | Bulk(Bag)                | 500              |

Refer to pages from p.205 to p.209 for mounting information.

### ■ Rated Value (□: packaging code)

| Part Number    | Common Mode Impedance (at 100MHz/20°C) | Rated Current | Rated Voltage | Insulation Resistance (min.) | Withstand Voltage | DC Resistance |            |
|----------------|--|---------------|---------------|------------------------------|-------------------|---------------|------------|
| DLP1NDN350HL4□ | 35ohm ±20%                             | 100mA         | 5Vdc          | 100M ohm                     | 12.5Vdc           | 1.8ohm±25%    | Kit HD UMP |
| DLP1NDN670HL4□ | 67ohm ±20%                             | 80mA          | 5Vdc          | 100M ohm                     | 12.5Vdc           | 2.9ohm±25%    | Kit HD UMP |
| DLP1NDN900HL4□ | 90ohm ±20%                             | 60mA          | 5Vdc          | 100M ohm                     | 12.5Vdc           | 3.7ohm±25%    | Kit HD UMP |

Operating Temperature Range: -40°C to +85°C Number of Circuit: 2

HD: for high speed differential signal lines UD: for ultra high speed differential signal lines

### ■ Impedance-Frequency Characteristics

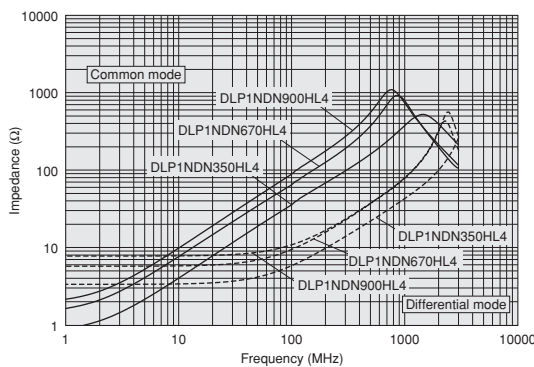

### ■ Differential Mode Transmission Characteristics (Typ.)

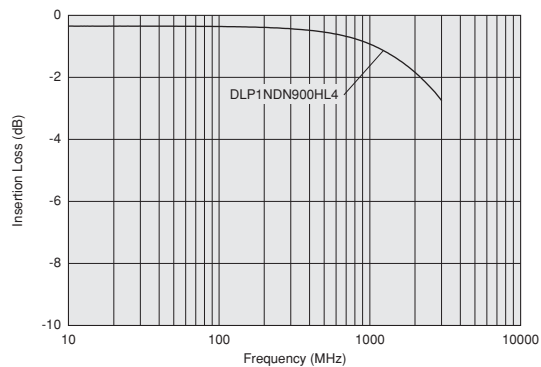

⚠Note • Please read rating and ⚠CAUTION (for storage, operating, rating, soldering, mounting and handling) in this catalog to prevent smoking and/or burning, etc.  
 • This catalog has only typical specifications. Therefore, please approve our product specifications or transact the approval sheet for product specifications before ordering.

# DLP2AD Series 0804/2010 (inch/mm)



2 circuit built-in, 0804 size, HDMI adapted type available, cut-off frequency 6GHz max.

### ■ Dimensions

0.25±0.1, 0.5±0.1, 0.92±0.1, 0.25±0.15, 1.0±0.1, 2.0±0.1

□ : Electrode (in mm)

### ■ Equivalent Circuit

No polarity.

### ■ Packaging

| Code | Packaging                | Minimum Quantity |
|------|--------------------------|------------------|
| L    | 180mm Reel Embossed Tape | 3000             |
| B    | Bulk (Bag)               | 500              |

Refer to pages from p.205 to p.209 for mounting information.

## ■ Rated Value (□: packaging code)

| Part Number    | Common Mode Impedance (at 100MHz/20°C) | Rated Current | Rated Voltage | Insulation Resistance (min.) | Withstand Voltage | DC Resistance |        |
|----------------|--|---------------|---------------|------------------------------|-------------------|---------------|--------|
| DLP2ADA350HL4□ | 35ohm ±20%                             | 150mA         | 5Vdc          | 100M ohm                     | 12.5Vdc           | 0.8ohm±25%    | Kit UD |
| DLP2ADA670HL4□ | 67ohm ±20%                             | 130mA         | 5Vdc          | 100M ohm                     | 12.5Vdc           | 1.0ohm±25%    | Kit UD |
| DLP2ADA900HL4□ | 90ohm ±20%                             | 120mA         | 5Vdc          | 100M ohm                     | 12.5Vdc           | 1.4ohm±25%    | Kit UD |
| DLP2ADN670HL4□ | 67ohm ±20%                             | 140mA         | 5Vdc          | 100M ohm                     | 12.5Vdc           | 1.3ohm±25%    | Kit HD |
| DLP2ADN900HL4□ | 90ohm ±20%                             | 130mA         | 5Vdc          | 100M ohm                     | 12.5Vdc           | 1.7ohm±25%    | Kit HD |
| DLP2ADN121HL4□ | 120ohm ±20%                            | 120mA         | 5Vdc          | 100M ohm                     | 12.5Vdc           | 2.0ohm±25%    | Kit HD |
| DLP2ADN161HL4□ | 160ohm ±20%                            | 100mA         | 5Vdc          | 100M ohm                     | 12.5Vdc           | 2.5ohm±25%    | Kit HD |
| DLP2ADN201HL4□ | 200ohm ±20%                            | 90mA          | 5Vdc          | 100M ohm                     | 12.5Vdc           | 3.2ohm±25%    | Kit HD |
| DLP2ADN241HL4□ | 240ohm ±20%                            | 80mA          | 5Vdc          | 100M ohm                     | 12.5Vdc           | 3.8ohm±25%    | Kit HD |
| DLP2ADN281HL4□ | 280ohm ±20%                            | 80mA          | 5Vdc          | 100M ohm                     | 12.5Vdc           | 4.6ohm±25%    | Kit HD |

Operating Temperature Range: -40°C to +85°C Number of Circuit: 2

HD: for high speed differential signal lines

UD: for ultra high speed differential signal lines

## ■ Impedance-Frequency Characteristics

### DLP2ADA Series

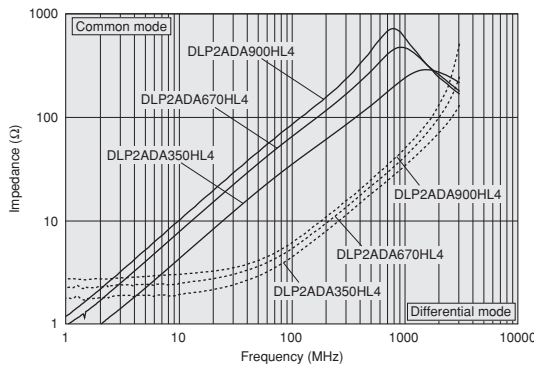

### DLP2ADN Series

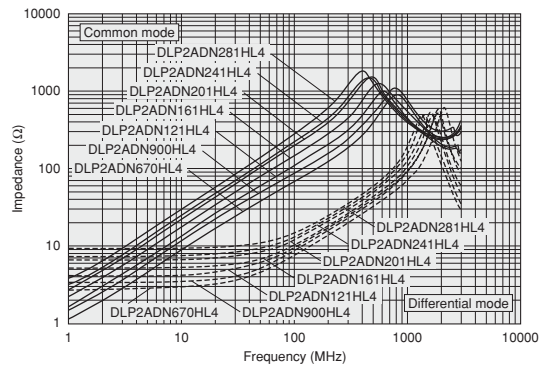

Continued on the following page.

△Note • Please read rating and △CAUTION (for storage, operating, rating, soldering, mounting and handling) in this catalog to prevent smoking and/or burning, etc.  
 • This catalog has only typical specifications. Therefore, please approve our product specifications or transact the approval sheet for product specifications before ordering.

Chip Ferrite Bead

Chip EMIFIL®

Chip Common Mode Choke Coil  
Signal Lines Type

Block Type EMIFIL®

Microwave Absorber

■ Differential Mode Transmission Characteristics (Typ.)

DLP2ADA Series

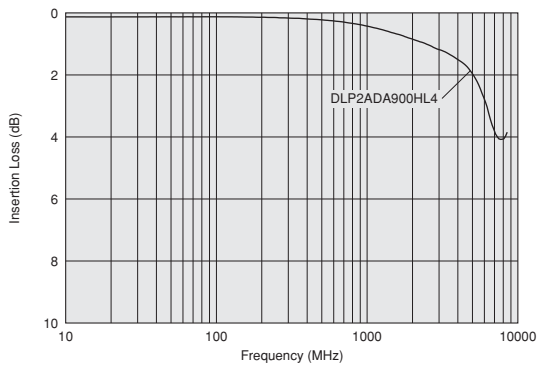

DLP2ADN Series

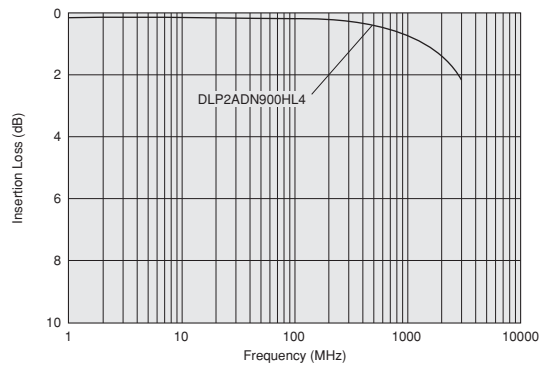

Chip Ferrite Bead

Chip EMIFIL®

Signal Lines Type  
 Chip Common Mode Choke Coil

Block Type EMIFIL®

Microwave Absorber

⚠Note • Please read rating and ⚠CAUTION (for storage, operating, rating, soldering, mounting and handling) in this catalog to prevent smoking and/or burning, etc.  
 • This catalog has only typical specifications. Therefore, please approve our product specifications or transact the approval sheet for product specifications before ordering.

# DLP31D Series 1206/3216 (inch/mm)



2 circuit built-in, 1206 size, meet IEEE1394, USB, LVDS.



### Dimensions

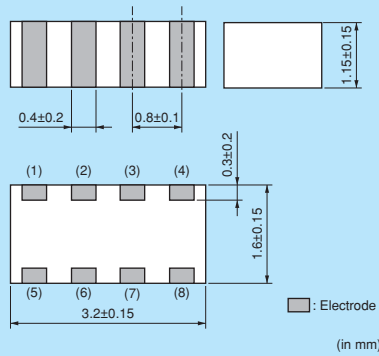

### Equivalent Circuit

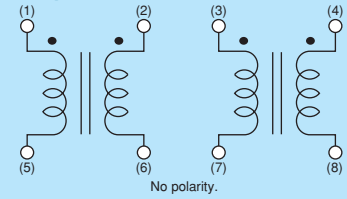

### Packaging

| Code | Packaging                | Minimum Quantity |
|------|--------------------------|------------------|
| L    | 180mm Reel Embossed Tape | 3000             |
| B    | Bulk(Bag)                | 500              |

Refer to pages from p.205 to p.209 for mounting information.

### Rated Value (□: packaging code)

| Part Number    | Common Mode Impedance (at 100MHz/20°C) | Rated Current | Rated Voltage | Insulation Resistance (min.) | Withstand Voltage | DC Resistance |    |
|----------------|--|---------------|---------------|------------------------------|-------------------|---------------|----|
| DLP31DN900ML4□ | 90ohm ±20%                             | 160mA         | 10Vdc         | 100M ohm                     | 25Vdc             | 1.1ohm max.   | HD |
| DLP31DN131ML4□ | 130ohm ±20%                            | 120mA         | 10Vdc         | 100M ohm                     | 25Vdc             | 1.1ohm max.   | HD |
| DLP31DN201ML4□ | 200ohm ±20%                            | 100mA         | 10Vdc         | 100M ohm                     | 25Vdc             | 2.2ohm max.   | HD |
| DLP31DN321ML4□ | 320ohm ±20%                            | 80mA          | 10Vdc         | 100M ohm                     | 25Vdc             | 3.5ohm max.   | HD |
| DLP31DN441ML4□ | 440ohm ±20%                            | 70mA          | 10Vdc         | 100M ohm                     | 25Vdc             | 4.3ohm max.   | HD |

Operating Temperature Range: -40°C to +85°C Number of Circuit: 2

HD: for high speed differential signal lines UD: for ultra high speed differential signal lines

### Impedance-Frequency Characteristics

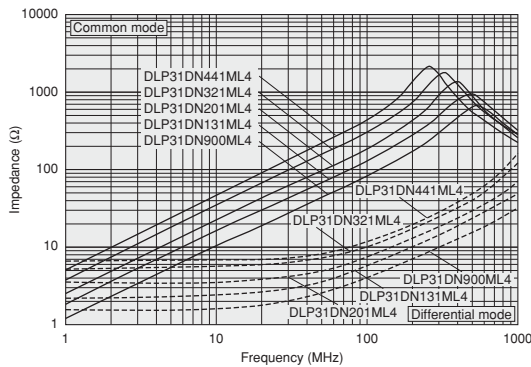

△Note • Please read rating and △CAUTION (for storage, operating, rating, soldering, mounting and handling) in this catalog to prevent smoking and/or burning, etc.  
 • This catalog has only typical specifications. Therefore, please approve our product specifications or transact the approval sheet for product specifications before ordering.

Chip Ferrite Bead

Chip EMIFIL®

Chip Common Mode Choke Coil  
Signal Lines Type

Block Type EMIFIL®

Microwave Absorber

# DLW21S Series 0805/2012 (inch/mm)



Wire-wound common choke, HDMI available type prepared.

### ■ Dimensions

### ■ Equivalent Circuit

### ■ Packaging

| Code | Packaging                | Minimum Quantity |
|------|--------------------------|------------------|
| L    | 180mm Reel Embossed Tape | 2000             |
| B    | Bulk(Bag)                | 500              |

Refer to pages from p.205 to p.209 for mounting information.

### ■ Rated Value (□: packaging code)

| Part Number    | Common Mode Impedance (at 100MHz/20°C) | Rated Current | Rated Voltage | Insulation Resistance (min.) | Withstand Voltage | DC Resistance |        |
|----------------|--|---------------|---------------|------------------------------|-------------------|---------------|--------|
| DLW21SN670SQ2□ | 67ohm ±25%                             | 400mA         | 50Vdc         | 10M ohm                      | 125Vdc            | 0.25ohm max.  | Kit HD |
| DLW21SN900SQ2□ | 90ohm ±25%                             | 330mA         | 50Vdc         | 10M ohm                      | 125Vdc            | 0.35ohm max.  | Kit HD |
| DLW21SN121SQ2□ | 120ohm ±25%                            | 370mA         | 50Vdc         | 10M ohm                      | 125Vdc            | 0.30ohm max.  | Kit HD |
| DLW21SN181SQ2□ | 180ohm ±25%                            | 330mA         | 50Vdc         | 10M ohm                      | 125Vdc            | 0.35ohm max.  | Kit HD |
| DLW21SN261SQ2□ | 260ohm ±25%                            | 300mA         | 50Vdc         | 10M ohm                      | 125Vdc            | 0.40ohm max.  | Kit HD |
| DLW21SN371SQ2□ | 370ohm ±25%                            | 280mA         | 50Vdc         | 10M ohm                      | 125Vdc            | 0.45ohm max.  | Kit HD |
| DLW21SN501SK2□ | 500ohm ±25%                            | 250mA         | 50Vdc         | 10M ohm                      | 125Vdc            | 0.5ohm max.   | Kit HD |

Operating Temperature Range: -40°C to +85°C Number of Circuit: 1

HD: for high speed differential signal lines UD: for ultra high speed differential signal lines

### ■ Impedance-Frequency Characteristics DLW21SN\_SQ2/SK2 Series

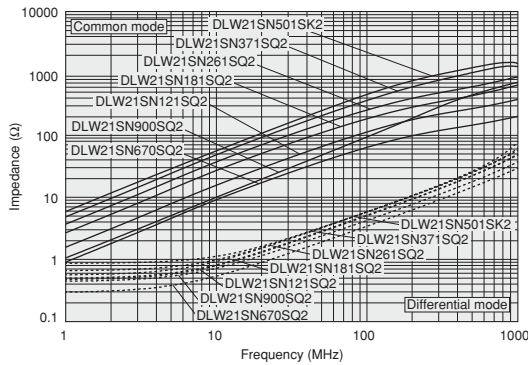

### ■ Rated Value (□: packaging code)

| Part Number    | Common Mode Impedance (at 100MHz/20°C) | Rated Current | Rated Voltage | Insulation Resistance (min.) | Withstand Voltage | DC Resistance |            |
|----------------|--|---------------|---------------|------------------------------|-------------------|---------------|------------|
| DLW21SN670HQ2□ | 67ohm ±25%                             | 320mA         | 20Vdc         | 10M ohm                      | 50Vdc             | 0.31ohm max.  | Kit UD Imp |
| DLW21SN900HQ2□ | 90ohm ±25%                             | 280mA         | 20Vdc         | 10M ohm                      | 50Vdc             | 0.41ohm max.  | Kit UD Imp |
| DLW21SN121HQ2□ | 120ohm ±25%                            | 280mA         | 20Vdc         | 10M ohm                      | 50Vdc             | 0.41ohm max.  | Kit UD Imp |
| DLW21SR670HQ2□ | 67ohm ±25%                             | 400mA         | 20Vdc         | 10M ohm                      | 50Vdc             | 0.25ohm max.  | Kit UD Imp |

Operating Temperature Range: -40°C to +85°C Number of Circuit: 1

HD: for high speed differential signal lines UD: for ultra high speed differential signal lines

DLW21SR670HQ2 is designed to correct line impedance when ESD protection device is also used.

Continued on the following page. ↗

△Note • Please read rating and △CAUTION (for storage, operating, rating, soldering, mounting and handling) in this catalog to prevent smoking and/or burning, etc.  
• This catalog has only typical specifications. Therefore, please approve our product specifications or transact the approval sheet for product specifications before ordering.

**Impedance-Frequency Characteristics**  
**DLW21SN\_HQ2 Series**

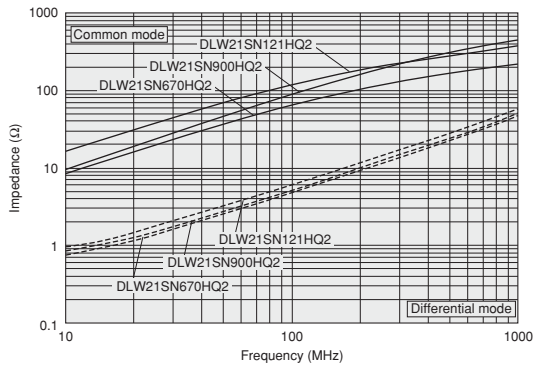

**DLW21SR\_HQ2 Series**

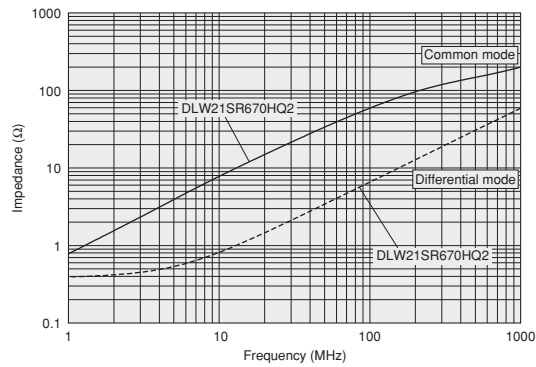

**Differential Mode Transmission Characteristics (Typ.)**  
**DLW21SN\_HQ2 Series**

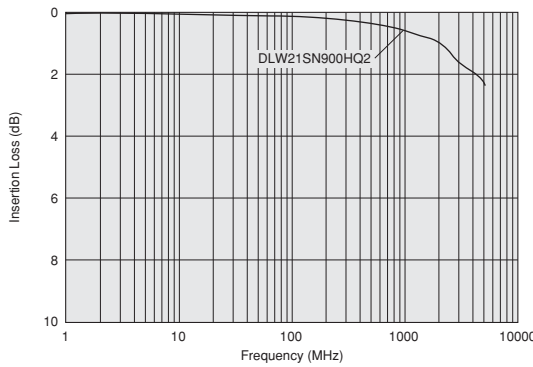

**Rated Value (□: packaging code)**

| Part Number    | Common Mode Impedance (at 100MHz/20°C) | Rated Current | Rated Voltage | Insulation Resistance (min.) | Withstand Voltage | DC Resistance |            |
|----------------|--|---------------|---------------|------------------------------|-------------------|---------------|------------|
| DLW21SN181XQ2□ | 180ohm ±25%                            | 240mA         | 20Vdc         | 10M ohm                      | 50Vdc             | 0.39ohm max.  | New Kit HD |
| DLW21SN261XQ2□ | 260ohm ±25%                            | 220mA         | 20Vdc         | 10M ohm                      | 50Vdc             | 0.59ohm max.  | New Kit HD |
| DLW21SN491XQ2□ | 490ohm ±25%                            | 190mA         | 20Vdc         | 10M ohm                      | 50Vdc             | 0.77ohm max.  | New Kit HD |

Operating Temperature Range: -40°C to +85°C Number of Circuit: 1

HD: for high speed differential signal lines UD: for ultra high speed differential signal lines

**Impedance-Frequency Characteristics**  
**DLW21SN\_XQ2 Series**

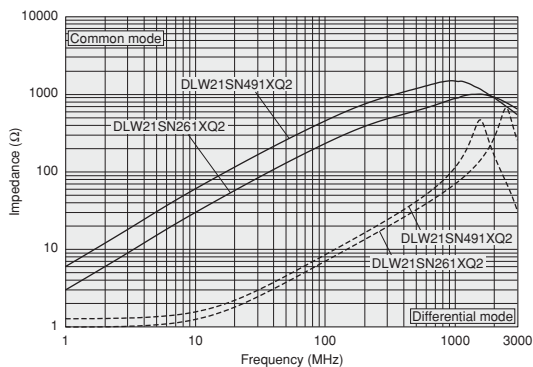

**Differential Mode Transmission Characteristics (Typ.)**  
**DLW21SN\_XQ2 Series**

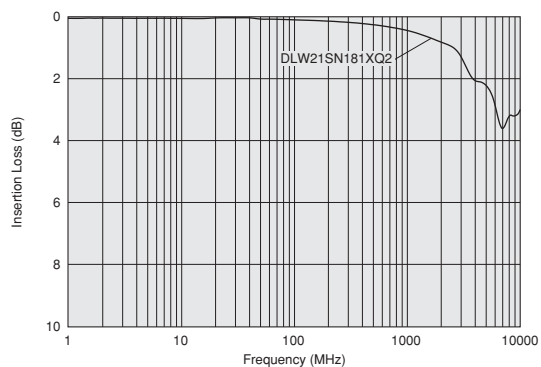

△Note • Please read rating and △CAUTION (for storage, operating, rating, soldering, mounting and handling) in this catalog to prevent smoking and/or burning, etc.  
• This catalog has only typical specifications. Therefore, please approve our product specifications or transact the approval sheet for product specifications before ordering.

Chip Ferrite Bead

Chip EMIFIL®

Chip Common Mode Choke Coil  
Signal Lines Type

Block Type EMIFIL®

Microwave Absorber



# DLW21H Series 0805/2012 (inch/mm)



Low profile wire-wound common choke coil, HDMI available type prepared.

### ■ Dimensions

(in mm)

### ■ Equivalent Circuit

### ■ Packaging

| Code | Packaging                | Minimum Quantity |
|------|--------------------------|------------------|
| L    | 180mm Reel Embossed Tape | 3000             |
| B    | Bulk(Bag)                | 500              |

Refer to pages from p.205 to p.209 for mounting information.

### ■ Rated Value (□: packaging code)

| Part Number    | Common Mode Impedance (at 100MHz/20°C) | Rated Current | Rated Voltage | Insulation Resistance (min.) | Withstand Voltage | DC Resistance |        |
|----------------|--|---------------|---------------|------------------------------|-------------------|---------------|--------|
| DLW21HN670SQ2□ | 67ohm ±25%                             | 330mA         | 50Vdc         | 10M ohm                      | 125Vdc            | 0.35ohm max.  | Kit HD |
| DLW21HN900SQ2□ | 90ohm ±25%                             | 330mA         | 50Vdc         | 10M ohm                      | 125Vdc            | 0.35ohm max.  | Kit HD |
| DLW21HN121SQ2□ | 120ohm ±25%                            | 280mA         | 50Vdc         | 10M ohm                      | 125Vdc            | 0.45ohm max.  | Kit HD |
| DLW21HN181SQ2□ | 180ohm ±25%                            | 250mA         | 50Vdc         | 10M ohm                      | 125Vdc            | 0.50ohm max.  | Kit HD |
| DLW21HN670HQ2□ | 67ohm ±25%                             | 240mA         | 20Vdc         | 10M ohm                      | 50Vdc             | 0.49ohm max.  | Kit UD |
| DLW21HN900HQ2□ | 90ohm ±25%                             | 220mA         | 20Vdc         | 10M ohm                      | 50Vdc             | 0.59ohm max.  | Kit UD |
| DLW21HN121HQ2□ | 120ohm ±25%                            | 200mA         | 20Vdc         | 10M ohm                      | 50Vdc             | 0.68ohm max.  | Kit UD |

Operating Temperature Range: -40°C to +85°C Number of Circuit: 1

HD: for high speed differential signal lines

UD: for ultra high speed differential signal lines

### ■ Impedance-Frequency Characteristics

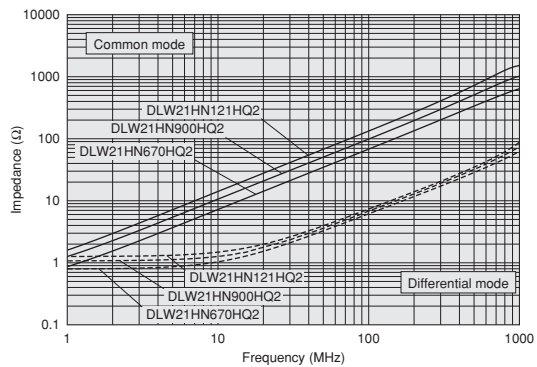
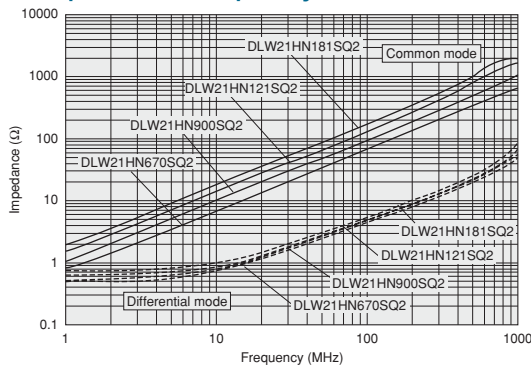

### ■ Differential Mode Transmission Characteristics (Typ.)

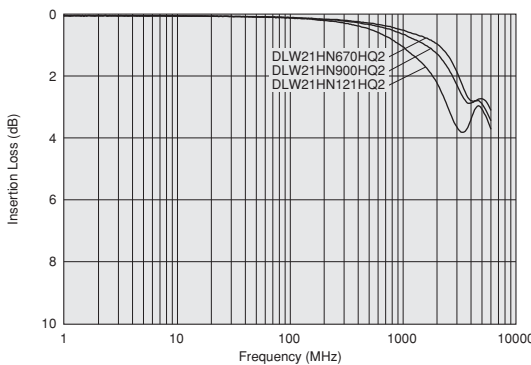

⚠Note • Please read rating and ⚠CAUTION (for storage, operating, rating, soldering, mounting and handling) in this catalog to prevent smoking and/or burning, etc.  
• This catalog has only typical specifications. Therefore, please approve our product specifications or transact the approval sheet for product specifications before ordering.

# DLW31S Series 1206/3216 (inch/mm)



## 1206 size wire-wound common mode choke coil.



### ■ Dimensions

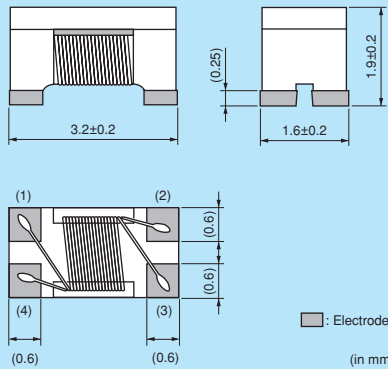

### ■ Equivalent Circuit

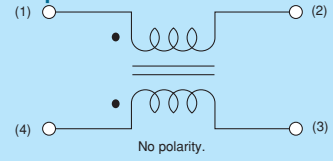

### ■ Packaging

| Code | Packaging                | Minimum Quantity |
|------|--------------------------|------------------|
| L    | 180mm Reel Embossed Tape | 2000             |
| B    | Bulk(Bag)                | 500              |

Refer to pages from p.205 to p.209 for mounting information.

### ■ Rated Value (□: packaging code)

| Part Number    | Common Mode Impedance (at 100MHz/20°C) | Rated Current | Rated Voltage | Insulation Resistance (min.) | Withstand Voltage | DC Resistance |    |
|----------------|--|---------------|---------------|------------------------------|-------------------|---------------|----|
| DLW31SN900SQ2□ | 90ohm ±25%                             | 370mA         | 50Vdc         | 10M ohm                      | 125Vdc            | 0.3ohm max.   | HD |
| DLW31SN161SQ2□ | 160ohm ±25%                            | 340mA         | 50Vdc         | 10M ohm                      | 125Vdc            | 0.4ohm max.   | HD |
| DLW31SN261SQ2□ | 260ohm ±25%                            | 310mA         | 50Vdc         | 10M ohm                      | 125Vdc            | 0.5ohm max.   | HD |
| DLW31SN601SQ2□ | 600ohm ±25%                            | 260mA         | 50Vdc         | 10M ohm                      | 125Vdc            | 0.8ohm max.   | HD |
| DLW31SN102SQ2□ | 1000ohm ±25%                           | 230mA         | 50Vdc         | 10M ohm                      | 125Vdc            | 1.0ohm max.   | HD |
| DLW31SN222SQ2□ | 2200ohm ±25%                           | 200mA         | 50Vdc         | 10M ohm                      | 125Vdc            | 1.2ohm max.   | HD |

Operating Temperature Range: -40°C to +85°C Number of Circuit: 1

HD: for high speed differential signal lines UD: for ultra high speed differential signal lines

### ■ Impedance-Frequency Characteristics

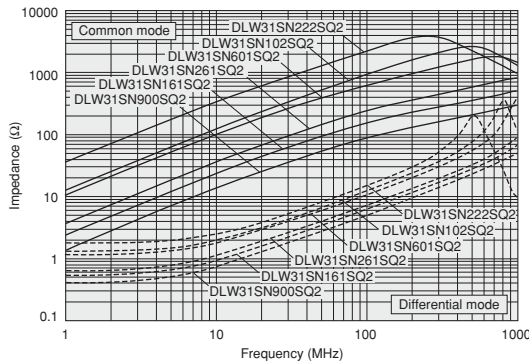

△Note • Please read rating and △CAUTION (for storage, operating, rating, soldering, mounting and handling) in this catalog to prevent smoking and/or burning, etc.  
 • This catalog has only typical specifications. Therefore, please approve our product specifications or transact the approval sheet for product specifications before ordering.

Chip Ferrite Bead

Chip EMIFIL®

Chip Common Mode Choke Coil  
Signal Lines Type

Block Type EMIFIL®

Microwave Absorber

# DLW43S Series 1812/4532 (inch/mm)



## 1812 size wire-wound common choke, Automotive Type.

**DLW43S\_XK**



**■ Dimensions**

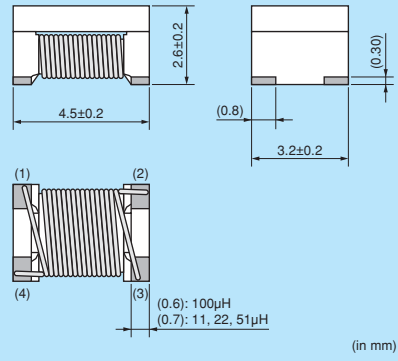

(in mm)

**■ Equivalent Circuit**

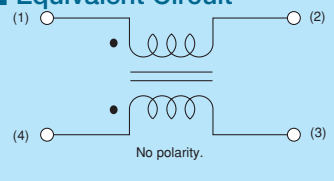

No polarity.

**■ Packaging**

| Code | Packaging                | Minimum Quantity |
|------|--------------------------|------------------|
| L    | 180mm Reel Embossed Tape | 500              |
| K    | 330mm Reel Embossed Tape | 2500             |
| B    | Bulk(Bag)                | 100              |

**DLW43S\_XP**



**■ Dimensions**

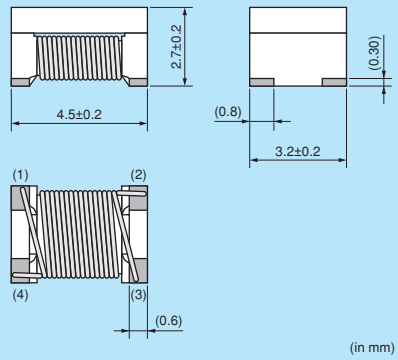

(in mm)

**■ Equivalent Circuit**

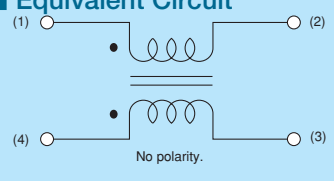

No polarity.

**■ Packaging**

| Code | Packaging                | Minimum Quantity |
|------|--------------------------|------------------|
| L    | 180mm Reel Embossed Tape | 500              |
| K    | 330mm Reel Embossed Tape | 2500             |
| B    | Bulk(Bag)                | 100              |

Refer to pages from p.205 to p.209 for mounting information.

**■ Rated Value (□: packaging code)**

| Part Number    | Common Mode Inductance      | Rated Current | Rated Voltage | Insulation Resistance (min.) | Withstand Voltage | DC Resistance | Operating Temperature Range |
|----------------|-----------------------------|---------------|---------------|------------------------------|-------------------|---------------|-----------------------------|
| DLW43SH110XK2□ | 11μH -30%/+50% (at 0.1MHz)  | 360mA         | 50Vdc         | 10M ohm                      | 125Vdc            | 0.5ohm max.   | -40°C to +125°C             |
| DLW43SH220XK2□ | 22μH -30%/+50% (at 0.1MHz)  | 310mA         | 50Vdc         | 10M ohm                      | 125Vdc            | 0.6ohm max.   | -40°C to +125°C             |
| DLW43SH510XK2□ | 51μH -30%/+50% (at 1MHz)    | 230mA         | 50Vdc         | 10M ohm                      | 125Vdc            | 1.0ohm max.   | -40°C to +125°C             |
| DLW43SH101XK2□ | 100μH -30%/+50% (at 1MHz)   | 200mA         | 50Vdc         | 10M ohm                      | 125Vdc            | 2.0ohm max.   | -40°C to +125°C             |
| DLW43SH101XP2□ | 100μH -30%/+80% (at 0.1MHz) | 170mA         | 50Vdc         | 10M ohm                      | 125Vdc            | 2.0ohm max.   | -40°C to +125°C             |

Number of Circuit: 1

**■ Impedance-Frequency Characteristics**

**DLW43S\_XK Series**

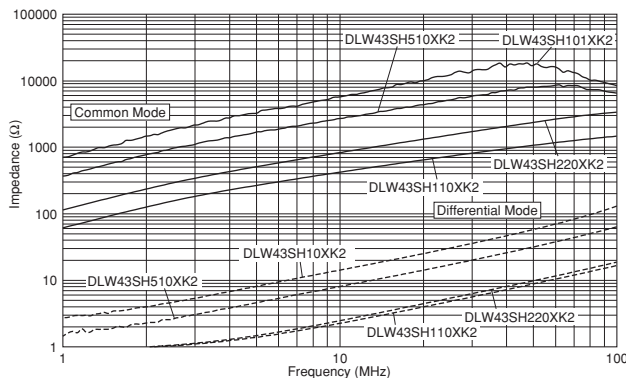

**DLW43S\_XP Series**

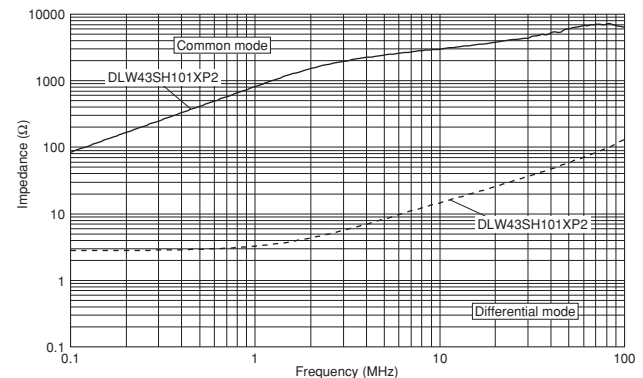

△Note • Please read rating and ⚠CAUTION (for storage, operating, rating, soldering, mounting and handling) in this catalog to prevent smoking and/or burning, etc.  
 • This catalog has only typical specifications. Therefore, please approve our product specifications or transact the approval sheet for product specifications before ordering.

# PLT10H Series (12.9x6.6mm)



Automotive application available, up to 18A.

### ■ Dimensions

### ■ Equivalent Circuit

### ■ Packaging

| Code | Packaging                | Minimum Quantity |
|------|--------------------------|------------------|
| L    | 180mm Reel Embossed Tape | 125              |
| K    | 330mm Reel Embossed Tape | 500              |
| B    | Bulk (Bag)               | 50               |

Refer to pages from p.210 to p.211 for mounting information.

### ■ Rated Value (□: packaging code)

| Part Number      | Common Mode Impedance (at 10MHz/20°C) | Rated Current | Rated Voltage | Insulation Resistance (min.) | Withstand Voltage | DC Resistance     | Inductance | Kit | ≥    |
|------------------|---------------------------------------|---------------|---------------|------------------------------|-------------------|-------------------|------------|-----|------|
| PLT10HH450180PN□ | 45ohm (Typ.)                          | 18A           | 300Vdc        | 10M ohm                      | 750Vdc            | 1.3m ohm±0.5m ohm | 0.8μH min. | Kit | ≥10A |
| PLT10HH101150PN□ | 100ohm (Typ.)                         | 15A           | 300Vdc        | 10M ohm                      | 750Vdc            | 1.8m ohm±0.5m ohm | 2.0μH min. | Kit | ≥10A |
| PLT10HH401100PN□ | 400ohm (Typ.)                         | 10A           | 100Vdc        | 10M ohm                      | 250Vdc            | 3.6m ohm±0.5m ohm | 6μH min.   | Kit | ≥10A |
| PLT10HH501100PN□ | 500ohm (Typ.)                         | 10A           | 100Vdc        | 10M ohm                      | 250Vdc            | 3.6m ohm±0.5m ohm | 9μH min.   | Kit | ≥10A |
| PLT10HH9016R0PN□ | 900ohm (Typ.)                         | 6A            | 100Vdc        | 10M ohm                      | 250Vdc            | 8.0m ohm±0.5m ohm | 14μH min.  | Kit | ≥3A  |
| PLT10HH1026R0PN□ | 1000ohm (Typ.)                        | 6A            | 100Vdc        | 10M ohm                      | 250Vdc            | 8.0m ohm±0.5m ohm | 20μH min.  | Kit | ≥3A  |

Operating Temperature Range (Self-temperature rise is included): -55°C to +105°C (PLT10HH 501100/1026R0 PN), -55°C to +125°C (PLT10HH 450180/101150/401100/9016R0 PN) Number of Circuit: 1

### ■ Impedance-Frequency Characteristics

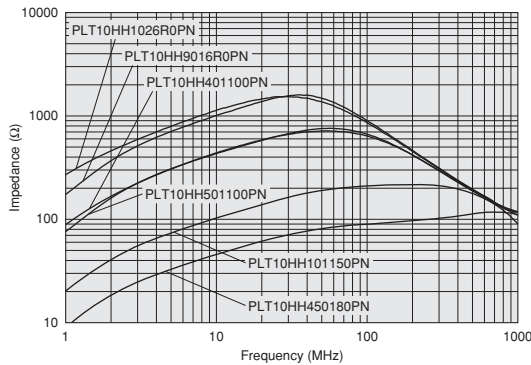

### ■ Notice (Rating)

In operating temperature exceeding +65°C, derating of current is necessary for PLT10H series.

Please apply the derating curve shown in chart according to the operating temperature.

#### Derating of Rated Current

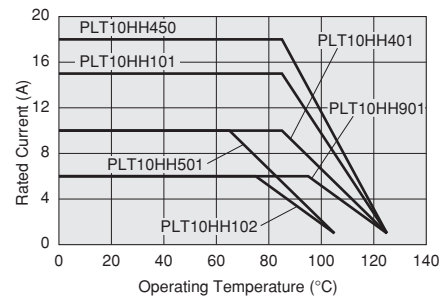

△Note • Please read rating and △CAUTION (for storage, operating, rating, soldering, mounting and handling) in this catalog to prevent smoking and/or burning, etc.  
• This catalog has only typical specifications. Therefore, please approve our product specifications or transact the approval sheet for product specifications before ordering.

Chip Ferrite Bead

Chip EMIFIL®

Chip Common Mode Choke Coil Power Lines Type

Block Type EMIFIL®

Microwave Absorber

## ⚠ Caution

## ● Rating

Do not use products beyond the rated current and rated voltage as this may create excessive heat and deteriorate the insulation resistance. Be sure to provide an appropriate fail-safe function on your product to prevent a second damage that may be caused by the abnormal function or the failure our product.

## ● Soldering and Mounting

## 1. Self-heating

Please provide special attention when mounting chip common mode choke coils DLW5 series in close proximity to other products that radiate heat.

The heat generated by other products may deteriorate the insulation resistance and cause excessive heat in this component.

## 2. Mounting Direction

Mount Chip Common Mode Choke Coils in right direction. Wrong direction, which is 90 degrees rotated from right direction, causes not only open or short circuit but also flames or other serious trouble.

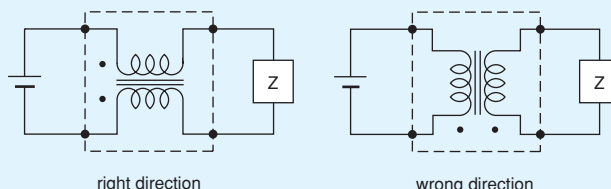

## Notice

## ● Storage and Operating Conditions

## &lt;Operating Environment&gt;

Do not use products in a chemical atmosphere such as chlorine gas, acid or sulfide gas.

Do not use products in the environment close to the organic solvent.

## &lt;Storage and Handling Requirements&gt;

## 1. Storage Period

DLM11G series should be used within 6 months, the other series should be used within 12 months.

Solderability should be checked if this period is exceeded.

## 2. Storage Conditions

## (1) Storage temperature: -10 to +40°C

Relative humidity: 15 to 85%

Avoid sudden changes in temperature and humidity.

## (2) Do not store products in a chemical atmosphere

such as chlorine gas, acid or sulfide gas.

## ● Notice (Soldering and Mounting)

## 1. Cleaning

Failure and degradation of a product are caused by the cleaning method. When you clean in conditions that are not in mounting information, please contact Murata engineering.

## 2. Soldering

Reliability decreases with improper soldering methods. Please solder by the standard soldering conditions shown in mounting information.

## 3. Other

Noise suppression levels resulting from Murata's EMI suppression filters EMIFIL® may vary, depending on the circuits and ICs used, type of noise, mounting pattern, mounting location, and other operating conditions. Be sure to check and confirm in advance the noise suppression effect of each filter, in actual circuits, etc. before applying the filter in a commercial-purpose equipment design.

## ● Handling

## 1. Resin Coating (Except for DLW Series.)

Using resin for coating/molding products may affect the products performance.

So please pay careful attention in selecting resin.

Prior to use, please make the reliability evaluation with the product mounted in your application set.

## 2. Resin Coating (DLW Series)

The impedance value may change due to high cure-stress of resin to be used for coating/molding products. An open circuit issue may occur by mechanical stress caused by the resin, amount/cured shape of resin, or operating condition etc. Some resin contains some impurities or chloride possible to generate chlorine by hydrolysis under some operating condition may cause corrosion of wire of coil, leading to open circuit.

So, please pay your careful attention in selecting resin in case of coating/molding the products with the resin. Prior to use the coating resin, please make sure no reliability issue is observed by evaluating products mounted on your board.

## 3. Caution for Use (DLW Series)

When you hold products with a tweezer, please hold by the sides. Sharp materials, such as a pair of tweezers, should not touch the winding portion to prevent breaking the wire. Mechanical shock should not be applied to the products mounted on the board to prevent breaking the core.

## 4. Brushing

When you clean the neighborhood of products such as connector pins, bristles of cleaning brush shall not be touched to the winding portion of this product to prevent the breaking of wire.

## 5. Handling of a Substrate

After mounting products on a substrate, do not apply any stress to the product caused by bending or twisting to the substrate when cropping the substrate, inserting and removing a connector from the substrate or tightening screw to the substrate. Excessive mechanical stress may cause cracking in the Product.



⚠ Note • Please read rating and ⚠ CAUTION (for storage, operating, rating, soldering, mounting and handling) in this catalog to prevent smoking and/or burning, etc.  
• This catalog has only typical specifications. Therefore, please approve our product specifications or transact the approval sheet for product specifications before ordering.

**⚠ Caution**

● **Rating**

1. Do not use products beyond the rated current and rated voltage as this may create excessive heat and deteriorate the insulation resistance.
2. Be sure to provide an appropriate fail-safe function on your product to prevent a second damage that may be caused by the abnormal function or the failure our product.

● **Soldering and Mounting**

1. Self-heating

Please provide special attention when mounting chip common mode choke coils in close proximity to other products that radiate heat. The heat generated by other products may deteriorate the insulation resistance and cause excessive heat in this component.

2. Mounting Direction

Mount Chip Common Mode Choke Coils in right direction. Wrong direction, which is 90 degrees rotated from right direction, causes not only open or short circuit but also flames or other serious trouble.

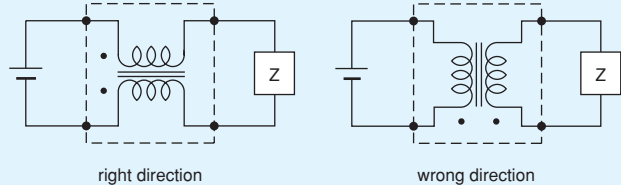

● **Storage and Operating Conditions**

<Operating Environment>

Do not use products in a chemical atmosphere such as chlorine gas, acid or sulfide gas.

Do not use products in the environment close to the organic solvent.

<Storage and Handling Requirements>

1. Storage Period

PLT10H series should be used within 12 months. Solderability should be checked if this period is exceeded.

2. Storage Conditions

- (1) Storage temperature: -10 to +40°C  
Relative humidity: 15 to 85%  
Avoid sudden changes in temperature and humidity.
- (2) Do not store products in a chemical atmosphere such as chlorine gas, acid or sulfide gas.

● **Notice (Soldering and Mounting)**

1. Cleaning

Failure and degradation of a product are caused by the cleaning method. When you clean in conditions that are not in mounting information, please contact Murata engineering.

2. Soldering

Reliability decreases with improper soldering methods. Please solder by the standard soldering conditions shown in mounting information.

3. Other

Noise suppression levels resulting from Murata's EMI suppression filters EMIFIL® may vary, depending on the circuits and ICs used, type of noise, mounting pattern, mounting location, and other operating conditions. Be sure to check and confirm in advance the noise suppression effect of each filter, in actual circuits, etc. before applying the filter in a commercial-purpose equipment design.

● **Handling**

1. Handling of a Substrate

After mounting products on a substrate, do not apply any stress to the product caused by bending or twisting to the substrate when cropping the substrate, inserting and removing a connector from the substrate or tightening screw to the substrate.

Excessive mechanical stress may cause cracking in the Product.

Bending

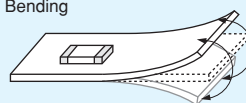

Twisting

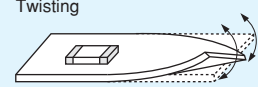

**Notice**

⚠ Note • Please read rating and ⚠ CAUTION (for storage, operating, rating, soldering, mounting and handling) in this catalog to prevent smoking and/or burning, etc.  
• This catalog has only typical specifications. Therefore, please approve our product specifications or transact the approval sheet for product specifications before ordering.

Chip Ferrite Bead  
Chip EMIFIL®  
Chip Common Mode Choke Coil  
Block Type EMIFIL®  
Microwave Absorber

### 1. Standard Land Pattern Dimensions

Land Pattern + Solder Resist  
 Land Pattern  
 Solder Resist (in mm)

DLM11S  
 DLM11G  
 DLP0QS  
 DLP0NS  
 DLP11S  
 DLP11R  
 DLP11T  
 DLP1ND  
 DLP2AD  
 DLP31S  
 DLP31D  
 DLW21S  
 DLW21H  
 DLW31SN  
 DLW43S  
 DLW5A  
 DLW5B

#### ●Reflow and Flow DLP31S

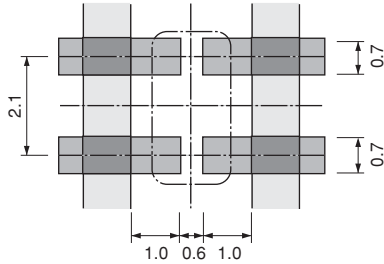

#### DLP31D

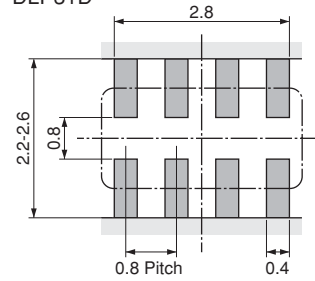

#### ●Reflow Soldering

##### DLP0QS

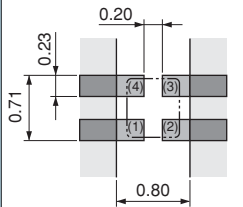

##### DLP0NS

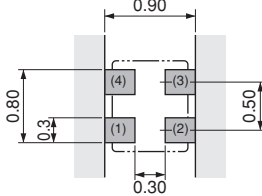

##### DLP11S/DLM11S

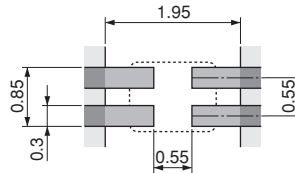

##### DLP11R/11T

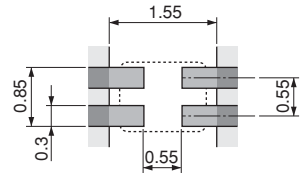

##### DLP1ND

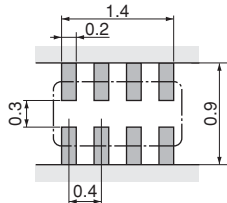

##### DLP2AD

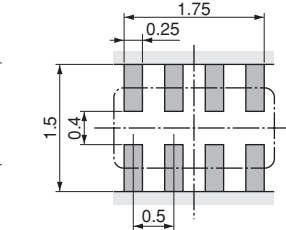

##### DLM11G

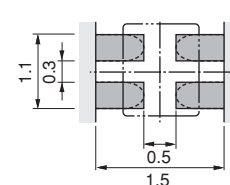

##### DLW21S/21H/31SN/43S

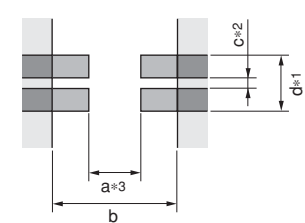

##### DLW5A/5B (Except for DLW5AT\_MQ2)

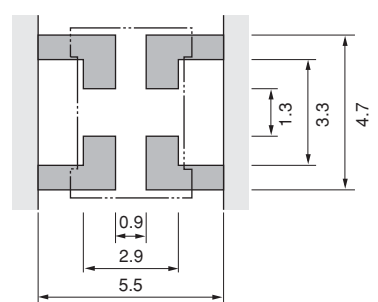

| Series             | a   | b   | c   | d   |
|--------------------|-----|-----|-----|-----|
| DLW21S/H           | 0.8 | 2.6 | 0.4 | 1.2 |
| DLW31SN            | 1.6 | 3.7 | 0.4 | 1.6 |
| DLW43SH110/220/510 | 3.0 | 5.9 | 1.6 | 3.4 |
| DLW43SH101         | 3.2 | 5.9 | 1.6 | 3.4 |

- \*1: If the pattern is made with wider than 1.2mm (DLW21) / 1.6mm (DLW31S) it may result in components turning around, because melting speed is different. In the worst case, short circuit between lines may occur.
- \*2: If the pattern is made with less than specified dimensions, in the worst case, short circuit between lines may occur due to spread of soldering paste or mount placing accuracy.
- \*3: If the pattern is made with wider than 0.8mm (DLW21) / 1.6mm (DLW31SN), the bending strength will be reduced. Do not use gild pattern; excess soldering heat may dissolve metal of a copper wire.

⚠Note • Please read rating and ⚠CAUTION (for storage, operating, rating, soldering, mounting and handling) in this catalog to prevent smoking and/or burning, etc.  
 • This catalog has only typical specifications. Therefore, please approve our product specifications or transact the approval sheet for product specifications before ordering.

Land Pattern + Solder Resist  
 Land Pattern  
 Solder Resist (in mm)

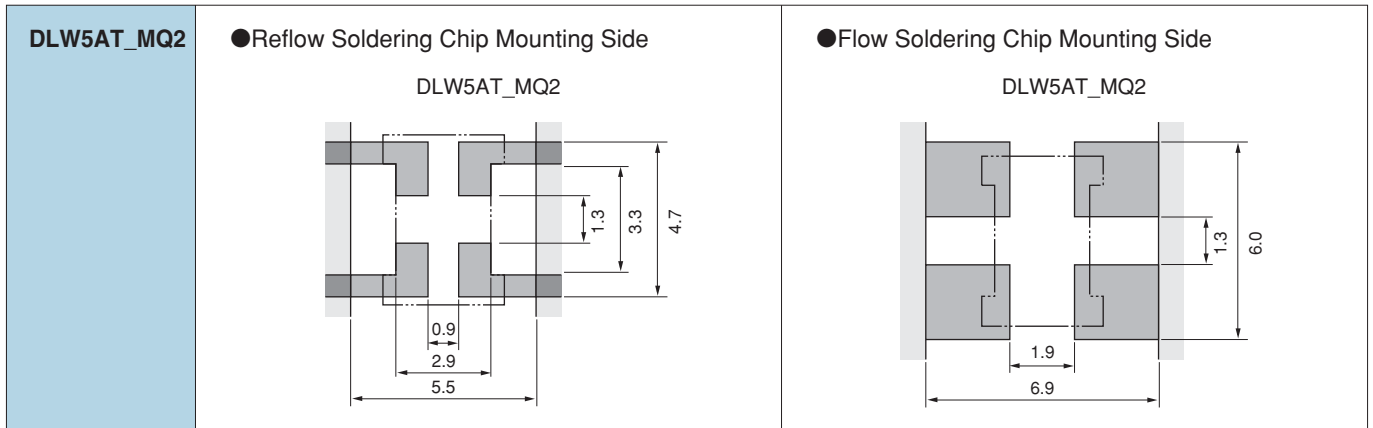

- PCB Warping  
PCB should be designed so that products are not subjected to the mechanical stress caused by warping the board.

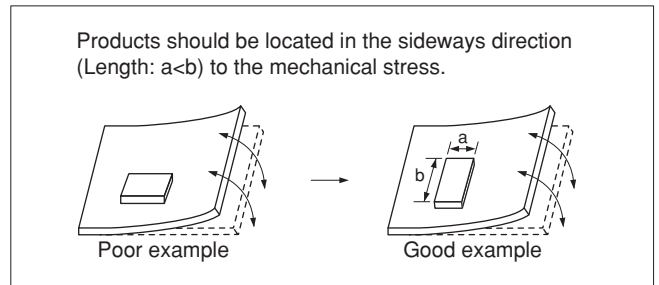

⚠Note • Please read rating and ⚠CAUTION (for storage, operating, rating, soldering, mounting and handling) in this catalog to prevent smoking and/or burning, etc.  
 • This catalog has only typical specifications. Therefore, please approve our product specifications or transact the approval sheet for product specifications before ordering.

Chip Ferrite Bead  
 Chip EMIFIL®  
 Soldering and Mounting  
 Chip Common Mode Choke Coil  
 Block Type EMIFIL®  
 Microwave Absorber



**2. Solder Paste Printing and Adhesive Application**

When reflow soldering the chip common mode choke coils, the printing must be conducted in accordance with the following cream solder printing conditions.

If too much solder is applied, the chip will be prone to damage by mechanical and thermal stress from the PCB and may crack.

Standard land dimensions should be used for resist and copper foil patterns.

When flow soldering the chip common mode choke coils, apply the adhesive in accordance with the following conditions.

If too much adhesive is applied, then it may overflow into the land or termination areas and yield poor solderability. In contrast, if insufficient adhesive is applied, or if the adhesive is not sufficiently hardened, then the chip may become detached during flow soldering process.

(in mm)

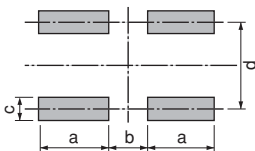
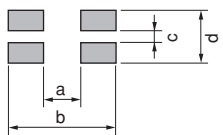
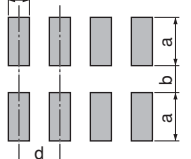
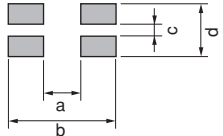
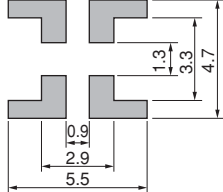
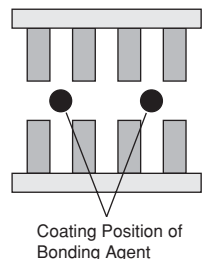
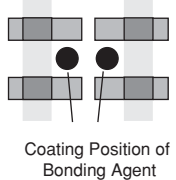
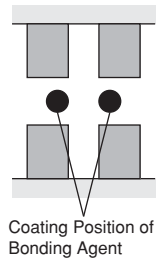
| Series                                 | Solder Paste Printing  | Adhesive Application |      |      |      |   |               |     |     |      |      |               |     |     |     |     |                      |     |      |     |      |                 |     |      |     |      |               |     |     |     |     |               |     |     |     |     |        |   |   |   |   |                 |     |     |     |     |               |     |     |     |     |        |   |   |   |   |               |     |     |     |     |               |      |     |      |     |               |     |     |     |     |        |   |   |   |   |               |                   |     |     |     |           |  |
|--|--|----------------------|------|------|------|---|---------------|-----|-----|------|------|---------------|-----|-----|-----|-----|----------------------|-----|------|-----|------|-----------------|-----|------|-----|------|---------------|-----|-----|-----|-----|---------------|-----|-----|-----|-----|--------|---|---|---|---|-----------------|-----|-----|-----|-----|---------------|-----|-----|-----|-----|--------|---|---|---|---|---------------|-----|-----|-----|-----|---------------|------|-----|------|-----|---------------|-----|-----|-----|-----|--------|---|---|---|---|---------------|-------------------|-----|-----|-----|-----------|--|
| <b>DLP</b><br><b>DLW</b><br><b>DLM</b> | <p>●Guideline of solder paste thickness:<br/>                     80-100μm: DLP0QS<br/>                     100-150μm: DLW21S/21H/31S, DLP0NS/11S/11R/11T/1ND/2AD/<br/>                     DLM11S/11G<br/>                     150μm: DLW43S<br/>                     150-200μm: DLP31D/31S, DLW5A/5B</p> <p>*Solderability is subject to reflow conditions and thermal conductivity. Please make sure that your product has been evaluated in view of your specifications with our product being mounted to your product.</p> <p>DLP0QS/0NS/11S/11R/11T/31S/DLM11S/11G</p>  <table border="1"> <thead> <tr> <th>Series</th> <th>a</th> <th>b</th> <th>c</th> <th>d</th> </tr> </thead> <tbody> <tr> <td><b>DLP0QS</b></td> <td>0.3</td> <td>0.2</td> <td>0.23</td> <td>0.48</td> </tr> <tr> <td><b>DLP0NS</b></td> <td>0.3</td> <td>0.3</td> <td>0.3</td> <td>0.5</td> </tr> <tr> <td><b>DLM11S/DLP11S</b></td> <td>0.7</td> <td>0.55</td> <td>0.3</td> <td>0.55</td> </tr> <tr> <td><b>DLP11R/T</b></td> <td>0.5</td> <td>0.55</td> <td>0.3</td> <td>0.55</td> </tr> <tr> <td><b>DLP31S</b></td> <td>1.0</td> <td>0.6</td> <td>0.7</td> <td>2.1</td> </tr> <tr> <td><b>DLM11G</b></td> <td>0.5</td> <td>0.5</td> <td>0.4</td> <td>0.7</td> </tr> </tbody> </table> <p>DLW21S/21H/31S</p>  <table border="1"> <thead> <tr> <th>Series</th> <th>a</th> <th>b</th> <th>c</th> <th>d</th> </tr> </thead> <tbody> <tr> <td><b>DLW21S/H</b></td> <td>0.8</td> <td>2.6</td> <td>0.5</td> <td>1.2</td> </tr> <tr> <td><b>DLW31S</b></td> <td>1.6</td> <td>3.7</td> <td>0.4</td> <td>1.6</td> </tr> </tbody> </table> <p>DLP1ND/2AD/31D</p>  <table border="1"> <thead> <tr> <th>Series</th> <th>a</th> <th>b</th> <th>c</th> <th>d</th> </tr> </thead> <tbody> <tr> <td><b>DLP1ND</b></td> <td>0.3</td> <td>0.3</td> <td>0.2</td> <td>0.4</td> </tr> <tr> <td><b>DLP2AD</b></td> <td>0.55</td> <td>0.4</td> <td>0.25</td> <td>0.5</td> </tr> <tr> <td><b>DLP31D</b></td> <td>1.0</td> <td>0.8</td> <td>0.4</td> <td>0.8</td> </tr> </tbody> </table> <p>DLW43S</p>  <table border="1"> <thead> <tr> <th>Series</th> <th>a</th> <th>b</th> <th>c</th> <th>d</th> </tr> </thead> <tbody> <tr> <td rowspan="2"><b>DLW43S</b></td> <td>3.0 (110/220/510)</td> <td rowspan="2">5.9</td> <td rowspan="2">1.6</td> <td rowspan="2">3.4</td> </tr> <tr> <td>3.2 (101)</td> </tr> </tbody> </table> <p>DLW5A/5B</p>  | Series               | a    | b    | c    | d | <b>DLP0QS</b> | 0.3 | 0.2 | 0.23 | 0.48 | <b>DLP0NS</b> | 0.3 | 0.3 | 0.3 | 0.5 | <b>DLM11S/DLP11S</b> | 0.7 | 0.55 | 0.3 | 0.55 | <b>DLP11R/T</b> | 0.5 | 0.55 | 0.3 | 0.55 | <b>DLP31S</b> | 1.0 | 0.6 | 0.7 | 2.1 | <b>DLM11G</b> | 0.5 | 0.5 | 0.4 | 0.7 | Series | a | b | c | d | <b>DLW21S/H</b> | 0.8 | 2.6 | 0.5 | 1.2 | <b>DLW31S</b> | 1.6 | 3.7 | 0.4 | 1.6 | Series | a | b | c | d | <b>DLP1ND</b> | 0.3 | 0.3 | 0.2 | 0.4 | <b>DLP2AD</b> | 0.55 | 0.4 | 0.25 | 0.5 | <b>DLP31D</b> | 1.0 | 0.8 | 0.4 | 0.8 | Series | a | b | c | d | <b>DLW43S</b> | 3.0 (110/220/510) | 5.9 | 1.6 | 3.4 | 3.2 (101) | <p>■ <b>DLP31S/DLP31D/ DLW5AT_MQ2</b><br/>                     Apply 0.3mg of bonding agent at each chip.</p> <p><b>DLP31D</b></p>  <p>Coating Position of Bonding Agent</p> <p><b>DLP31S</b></p>  <p>Coating Position of Bonding Agent</p> <p><b>DLW5AT_MQ2</b></p>  <p>Coating Position of Bonding Agent</p> |
|  | Series   | a                    | b    | c    | d    |   |               |     |     |      |      |               |     |     |     |     |                      |     |      |     |      |                 |     |      |     |      |               |     |     |     |     |               |     |     |     |     |        |   |   |   |   |                 |     |     |     |     |               |     |     |     |     |        |   |   |   |   |               |     |     |     |     |               |      |     |      |     |               |     |     |     |     |        |   |   |   |   |               |                   |     |     |     |           |  |
|  | <b>DLP0QS</b>  | 0.3                  | 0.2  | 0.23 | 0.48 |   |               |     |     |      |      |               |     |     |     |     |                      |     |      |     |      |                 |     |      |     |      |               |     |     |     |     |               |     |     |     |     |        |   |   |   |   |                 |     |     |     |     |               |     |     |     |     |        |   |   |   |   |               |     |     |     |     |               |      |     |      |     |               |     |     |     |     |        |   |   |   |   |               |                   |     |     |     |           |  |
|  | <b>DLP0NS</b>  | 0.3                  | 0.3  | 0.3  | 0.5  |   |               |     |     |      |      |               |     |     |     |     |                      |     |      |     |      |                 |     |      |     |      |               |     |     |     |     |               |     |     |     |     |        |   |   |   |   |                 |     |     |     |     |               |     |     |     |     |        |   |   |   |   |               |     |     |     |     |               |      |     |      |     |               |     |     |     |     |        |   |   |   |   |               |                   |     |     |     |           |  |
|  | <b>DLM11S/DLP11S</b>   | 0.7                  | 0.55 | 0.3  | 0.55 |   |               |     |     |      |      |               |     |     |     |     |                      |     |      |     |      |                 |     |      |     |      |               |     |     |     |     |               |     |     |     |     |        |   |   |   |   |                 |     |     |     |     |               |     |     |     |     |        |   |   |   |   |               |     |     |     |     |               |      |     |      |     |               |     |     |     |     |        |   |   |   |   |               |                   |     |     |     |           |  |
|  | <b>DLP11R/T</b>  | 0.5                  | 0.55 | 0.3  | 0.55 |   |               |     |     |      |      |               |     |     |     |     |                      |     |      |     |      |                 |     |      |     |      |               |     |     |     |     |               |     |     |     |     |        |   |   |   |   |                 |     |     |     |     |               |     |     |     |     |        |   |   |   |   |               |     |     |     |     |               |      |     |      |     |               |     |     |     |     |        |   |   |   |   |               |                   |     |     |     |           |  |
|  | <b>DLP31S</b>  | 1.0                  | 0.6  | 0.7  | 2.1  |   |               |     |     |      |      |               |     |     |     |     |                      |     |      |     |      |                 |     |      |     |      |               |     |     |     |     |               |     |     |     |     |        |   |   |   |   |                 |     |     |     |     |               |     |     |     |     |        |   |   |   |   |               |     |     |     |     |               |      |     |      |     |               |     |     |     |     |        |   |   |   |   |               |                   |     |     |     |           |  |
|  | <b>DLM11G</b>  | 0.5                  | 0.5  | 0.4  | 0.7  |   |               |     |     |      |      |               |     |     |     |     |                      |     |      |     |      |                 |     |      |     |      |               |     |     |     |     |               |     |     |     |     |        |   |   |   |   |                 |     |     |     |     |               |     |     |     |     |        |   |   |   |   |               |     |     |     |     |               |      |     |      |     |               |     |     |     |     |        |   |   |   |   |               |                   |     |     |     |           |  |
|  | Series   | a                    | b    | c    | d    |   |               |     |     |      |      |               |     |     |     |     |                      |     |      |     |      |                 |     |      |     |      |               |     |     |     |     |               |     |     |     |     |        |   |   |   |   |                 |     |     |     |     |               |     |     |     |     |        |   |   |   |   |               |     |     |     |     |               |      |     |      |     |               |     |     |     |     |        |   |   |   |   |               |                   |     |     |     |           |  |
|  | <b>DLW21S/H</b>  | 0.8                  | 2.6  | 0.5  | 1.2  |   |               |     |     |      |      |               |     |     |     |     |                      |     |      |     |      |                 |     |      |     |      |               |     |     |     |     |               |     |     |     |     |        |   |   |   |   |                 |     |     |     |     |               |     |     |     |     |        |   |   |   |   |               |     |     |     |     |               |      |     |      |     |               |     |     |     |     |        |   |   |   |   |               |                   |     |     |     |           |  |
| <b>DLW31S</b>                          | 1.6  | 3.7                  | 0.4  | 1.6  |      |   |               |     |     |      |      |               |     |     |     |     |                      |     |      |     |      |                 |     |      |     |      |               |     |     |     |     |               |     |     |     |     |        |   |   |   |   |                 |     |     |     |     |               |     |     |     |     |        |   |   |   |   |               |     |     |     |     |               |      |     |      |     |               |     |     |     |     |        |   |   |   |   |               |                   |     |     |     |           |  |
| Series                                 | a  | b                    | c    | d    |      |   |               |     |     |      |      |               |     |     |     |     |                      |     |      |     |      |                 |     |      |     |      |               |     |     |     |     |               |     |     |     |     |        |   |   |   |   |                 |     |     |     |     |               |     |     |     |     |        |   |   |   |   |               |     |     |     |     |               |      |     |      |     |               |     |     |     |     |        |   |   |   |   |               |                   |     |     |     |           |  |
| <b>DLP1ND</b>                          | 0.3  | 0.3                  | 0.2  | 0.4  |      |   |               |     |     |      |      |               |     |     |     |     |                      |     |      |     |      |                 |     |      |     |      |               |     |     |     |     |               |     |     |     |     |        |   |   |   |   |                 |     |     |     |     |               |     |     |     |     |        |   |   |   |   |               |     |     |     |     |               |      |     |      |     |               |     |     |     |     |        |   |   |   |   |               |                   |     |     |     |           |  |
| <b>DLP2AD</b>                          | 0.55   | 0.4                  | 0.25 | 0.5  |      |   |               |     |     |      |      |               |     |     |     |     |                      |     |      |     |      |                 |     |      |     |      |               |     |     |     |     |               |     |     |     |     |        |   |   |   |   |                 |     |     |     |     |               |     |     |     |     |        |   |   |   |   |               |     |     |     |     |               |      |     |      |     |               |     |     |     |     |        |   |   |   |   |               |                   |     |     |     |           |  |
| <b>DLP31D</b>                          | 1.0  | 0.8                  | 0.4  | 0.8  |      |   |               |     |     |      |      |               |     |     |     |     |                      |     |      |     |      |                 |     |      |     |      |               |     |     |     |     |               |     |     |     |     |        |   |   |   |   |                 |     |     |     |     |               |     |     |     |     |        |   |   |   |   |               |     |     |     |     |               |      |     |      |     |               |     |     |     |     |        |   |   |   |   |               |                   |     |     |     |           |  |
| Series                                 | a  | b                    | c    | d    |      |   |               |     |     |      |      |               |     |     |     |     |                      |     |      |     |      |                 |     |      |     |      |               |     |     |     |     |               |     |     |     |     |        |   |   |   |   |                 |     |     |     |     |               |     |     |     |     |        |   |   |   |   |               |     |     |     |     |               |      |     |      |     |               |     |     |     |     |        |   |   |   |   |               |                   |     |     |     |           |  |
| <b>DLW43S</b>                          | 3.0 (110/220/510)  | 5.9                  | 1.6  | 3.4  |      |   |               |     |     |      |      |               |     |     |     |     |                      |     |      |     |      |                 |     |      |     |      |               |     |     |     |     |               |     |     |     |     |        |   |   |   |   |                 |     |     |     |     |               |     |     |     |     |        |   |   |   |   |               |     |     |     |     |               |      |     |      |     |               |     |     |     |     |        |   |   |   |   |               |                   |     |     |     |           |  |
|  | 3.2 (101)  |                      |      |      |      |   |               |     |     |      |      |               |     |     |     |     |                      |     |      |     |      |                 |     |      |     |      |               |     |     |     |     |               |     |     |     |     |        |   |   |   |   |                 |     |     |     |     |               |     |     |     |     |        |   |   |   |   |               |     |     |     |     |               |      |     |      |     |               |     |     |     |     |        |   |   |   |   |               |                   |     |     |     |           |  |

△Note • Please read rating and △CAUTION (for storage, operating, rating, soldering, mounting and handling) in this catalog to prevent smoking and/or burning, etc.  
 • This catalog has only typical specifications. Therefore, please approve our product specifications or transact the approval sheet for product specifications before ordering.

**3. Standard Soldering Conditions**

(1) Soldering Methods

Use flow and reflow soldering methods only.  
 Use standard soldering conditions when soldering chip common mode choke coils.  
 In cases where several different parts are soldered, each having different soldering conditions, use those conditions requiring the least heat and minimum time.

Solder: Use Sn-3.0Ag-0.5Cu solder. Use of Sn-Zn based solder will deteriorate performance of products.  
 If using DLP/DLM series with Sn-Zn based solder, please contact Murata in advance.

Flux:

- Use Rosin-based flux.  
 In case of DLW21/31 series, use Rosin-based flux with converting chlorine content of 0.06 to 0.1wt%.  
 In case of using RA type solder, products should be cleaned completely with no residual flux.
- Do not use strong acidic flux (with chlorine content exceeding 0.20wt%)
- Do not use water-soluble flux.

For additional mounting methods, please contact Murata.

(2) Soldering Profile

● Flow Soldering Profile  
 (Sn-3.0Ag-0.5Cu Solder)

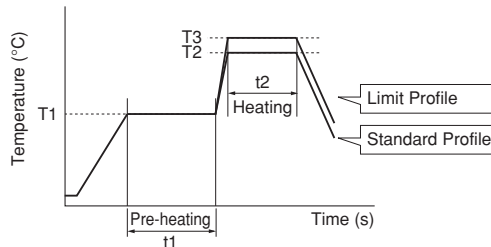

| Series                                 | Pre-heating |            | Standard Profile |            |               | Limit Profile |            |               |
|--|-------------|------------|------------------|------------|---------------|---------------|------------|---------------|
|  | Temp. (T1)  | Time. (t1) | Heating          |            | Cycle of Flow | Heating       |            | Cycle of Flow |
|  |             |            | Temp. (T2)       | Time. (t2) |               | Temp. (T3)    | Time. (t2) |               |
| <b>DLW5AT_MQ2</b><br><b>DLP31D/31S</b> | 150°C       | 60s min.   | 250°C            | 4 to 6s    | 2 times max.  | 265±3°C       | 5s max.    | 2 times max.  |

● Reflow Soldering Profile  
 (Sn-3.0Ag-0.5Cu Solder)

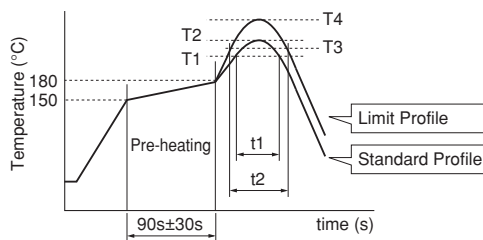

| Series                            | Standard Profile |            |                       |                 | Limit Profile |            |                       |                 |
|-----------------------------------|------------------|------------|-----------------------|-----------------|---------------|------------|-----------------------|-----------------|
|                                   | Heating          |            | Peak Temperature (T2) | Cycle of Reflow | Heating       |            | Peak Temperature (T4) | Cycle of Reflow |
|                                   | Temp. (T1)       | Time. (t1) |                       |                 | Temp. (T3)    | Time. (t2) |                       |                 |
| <b>DLM/DLP</b><br><b>DLW21/31</b> | 220°C min.       | 30 to 60s  | 245±3°C               | 2 times max.    | 230°C min.    | 60s max.   | 260°C/10s             | 2 times max.    |
| <b>DLW43S</b>                     | 220°C min.       | 30 to 60s  | 245±3°C               | 2 times max.    | 240°C min.    | 30s max.   | 260°C/10s             | 2 times max.    |
| <b>DLW5A/5B</b>                   | 220°C min.       | 30 to 60s  | 250±3°C               | 2 times max.    | 230°C min.    | 60s max.   | 260°C/10s             | 2 times max.    |

△Note • Please read rating and △CAUTION (for storage, operating, rating, soldering, mounting and handling) in this catalog to prevent smoking and/or burning, etc.  
 • This catalog has only typical specifications. Therefore, please approve our product specifications or transact the approval sheet for product specifications before ordering.

Chip Ferrite Bead  
Chip EMIFIL®  
Soldering and Mounting  
Chip Common Mode Choke Coil  
Block Type EMIFIL®  
Microwave Absorber

## (3) Reworking with Solder Iron

The following conditions must be strictly followed when using a soldering iron.

Pre-heating: 150°C 60s min.

Soldering iron power output / Tip diameter:

30W max. / ø3mm max.

Temperature of soldering iron tip / Soldering time / Times:

350°C max. / 3-4s / 2 times\*<sup>1</sup>

\*<sup>1</sup> DLP0QS, DLP0NS, DLP11S, DLP11T, DLP1ND,

DLP2AD: 380°C max. / 3-4s / 2 times

DLW43S: 350°C max. / 3s / 2 times

Do not allow the tip of the soldering iron to directly contact the chip.

For additional methods of reworking with a soldering iron, please contact Murata engineering.

#### 4. Cleaning

Following conditions should be observed when cleaning chip EMI filter.

(1) Cleaning Temperature: 60°C max. (40°C max. for alcohol type cleaner)

(2) Ultrasonic

Output: 20W/liter max.

Duration: 5 minutes max.

Frequency: 28 to 40kHz

(3) Cleaning agent

The following list of cleaning agents have been tested on the individual components. Evaluation of final assembly should be completed prior to production.

Do not clean DLW (Except for DLW21H) series.

Before cleaning, please contact Murata engineering.

(a) Alcohol cleaning agent

Isopropyl alcohol (IPA)

(b) Aqueous cleaning agent

Pine Alpha ST-100S

(4) Ensure that flux residue is completely removed.

Component should be thoroughly dried after aqueous agent has been removed with deionized water.

⚠Note • Please read rating and ⚠CAUTION (for storage, operating, rating, soldering, mounting and handling) in this catalog to prevent smoking and/or burning, etc.  
• This catalog has only typical specifications. Therefore, please approve our product specifications or transact the approval sheet for product specifications before ordering.

#### 1. Standard Land Pattern Dimensions

(in mm)

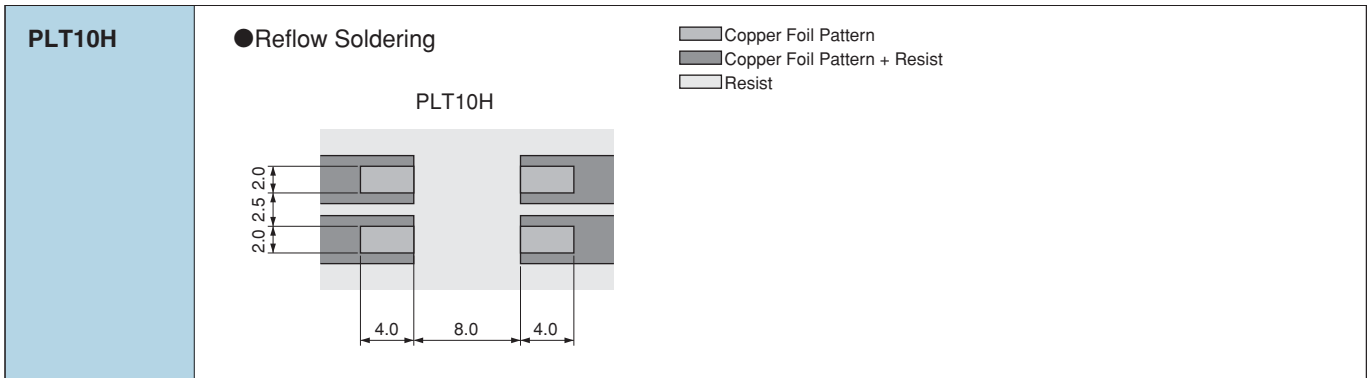

#### ● PCB Warping

PCB should be designed so that products are not subjected to the mechanical stress caused by warping the board.

Products should be located in the sideways direction (Length: a<b) to the mechanical stress.

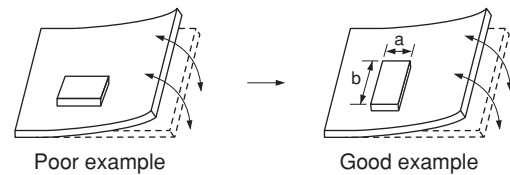

#### 2. Solder Paste Printing and Adhesive Application

When reflow soldering the chip common mode choke coils, the printing must be conducted in accordance with the following cream solder printing conditions.

If too much solder is applied, the chip will be prone to damage by mechanical and thermal stress from the PCB and may crack.

Standard land dimensions should be used for resist and copper foil patterns.

When flow soldering the chip common mode choke coils, apply the adhesive in accordance with the following conditions.

If too much adhesive is applied, then it may overflow into the land or termination areas and yield poor solderability. In contrast, if insufficient adhesive is applied, or if the adhesive is not sufficiently hardened, then the chip may become detached during flow soldering process.

| Series        | Solder Paste Printing  |
|---------------|--|
| <b>PLT10H</b> | <p>● Guideline of solder paste thickness:<br/>150-200<math>\mu</math>m: PLT10H<br/>For the solder paste printing pattern, use standard land dimensions.</p> <p>*Solderability is subject to reflow conditions and thermal conductivity. Please make sure that your product has been evaluated in view of your specifications with our product being mounted to your product.</p> |

△Note • Please read rating and △CAUTION (for storage, operating, rating, soldering, mounting and handling) in this catalog to prevent smoking and/or burning, etc.  
• This catalog has only typical specifications. Therefore, please approve our product specifications or transact the approval sheet for product specifications before ordering.

Chip Ferrite Bead  
Chip EMIFIL®  
Soldering and Mounting  
Chip Common Mode Choke Coil  
Block Type EMIFIL®  
Microwave Absorber

### 3. Standard Soldering Conditions

(1) Soldering Methods

Use reflow soldering methods only.  
 Use standard soldering conditions when soldering chip common mode choke coils.  
 In cases where several different parts are soldered, each having different soldering conditions, use those conditions requiring the least heat and minimum time.

Solder: Use Sn-3.0Ag-0.5Cu solder. Use of Sn-Zn based solder will deteriorate performance of products.

Flux:

- Use Rosin-based flux.
- Do not use strong acidic flux (with chlorine content exceeding 0.20wt%)
- Do not use water-soluble flux.

For additional mounting methods, please contact Murata.

(2) Soldering Profile

● Reflow Soldering Profile  
 (Sn-3.0Ag-0.5Cu Solder)

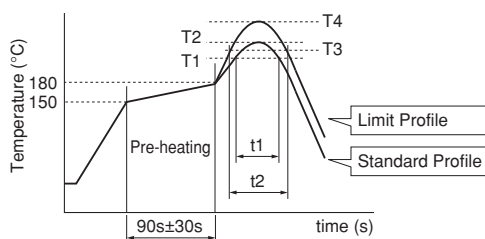

| Series        | Standard Profile |            |                       |                 | Limit Profile |            |                       |                 |
|---------------|------------------|------------|-----------------------|-----------------|---------------|------------|-----------------------|-----------------|
|               | Heating          |            | Peak Temperature (T2) | Cycle of Reflow | Heating       |            | Peak Temperature (T4) | Cycle of Reflow |
|               | Temp. (T1)       | Time. (t1) |                       |                 | Temp. (T3)    | Time. (t2) |                       |                 |
| <b>PLT10H</b> | 220°C min.       | 30 to 60s  | 250±3°C               | 2 times max.    | 230°C min.    | 60s max.   | 260°C/10s             | 2 times max.    |

(3) Reworking with Solder Iron

The following conditions must be strictly followed when using a soldering iron.  
 Pre-heating: 150°C 60s min.  
 Soldering iron power output / Tip diameter:  
 80W max. / ø3mm max.  
 Temperature of soldering iron tip / Soldering time / Times:  
 400°C max. / 5s / 2 times

Do not allow the tip of the soldering iron to directly contact the chip.  
 For additional methods of reworking with a soldering iron, please contact Murata engineering.

### 4. Cleaning

Do not clean after soldering. If cleaning, please contact us.

△Note • Please read rating and △CAUTION (for storage, operating, rating, soldering, mounting and handling) in this catalog to prevent smoking and/or burning, etc.  
 • This catalog has only typical specifications. Therefore, please approve our product specifications or transact the approval sheet for product specifications before ordering.

## ■ Minimum Quantity and Dimensions of 8mm Width Paper / Embossed Tape

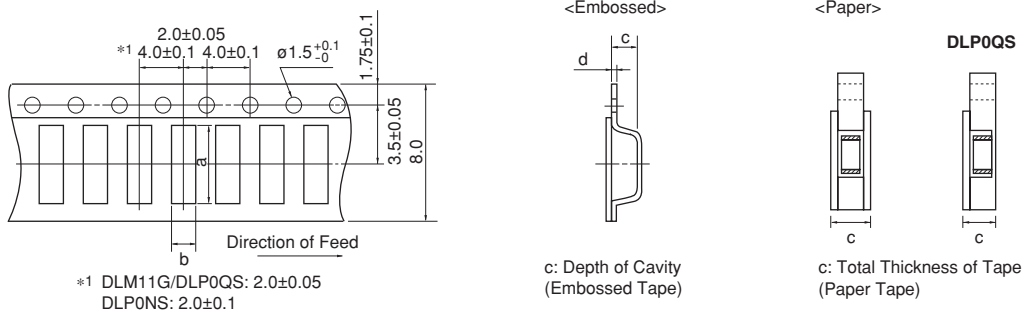

Dimension of the cavity of embossed tape is measured at the bottom side.

| Part Number | Dimensions |      |           |      | Minimum Qty. (pcs.) |               |             |               | Bulk |
|-------------|------------|------|-----------|------|---------------------|---------------|-------------|---------------|------|
|             |            |      |           |      | ø180mm Reel         |               | ø330mm Reel |               |      |
|             | a          | b    | c         | d    | Paper Tape          | Embossed Tape | Paper Tape  | Embossed Tape |      |
| DLM11G      | 1.45       | 1.2  | 0.8 max.  | -    | 10000               | -             | -           | -             | 1000 |
| DLM11S      | 1.4        | 1.15 | 0.65      | 0.25 | -                   | 4000          | -           | -             | 500  |
| DLP0QS      | 0.73       | 0.6  | 0.55 max. | -    | 15000               | -             | -           | -             | 500  |
| DLP0NS      | 0.95       | 0.75 | 0.55      | 0.25 | -                   | 10000         | -           | -             | 500  |
| DLP11S      | 1.4        | 1.2  | 0.98      | 0.25 | -                   | 3000          | -           | -             | 500  |
| DLP11R      | 1.4        | 1.15 | 0.7       | 0.25 | -                   | 4000          | -           | -             | 500  |
| DLP11T      | 1.35       | 1.1  | 0.45      | 0.25 | -                   | 5000          | -           | -             | 500  |
| DLP1ND      | 1.7        | 0.84 | 0.57      | 0.25 | -                   | 5000          | -           | -             | 500  |
| DLP2AD      | 2.2        | 1.2  | 0.98      | 0.25 | -                   | 3000          | -           | -             | 500  |
| DLP31D/31S  | 3.5        | 1.9  | 1.3       | 0.25 | -                   | 3000          | -           | -             | 500  |
| DLW21S      | 2.25       | 1.45 | 1.4       | 0.3  | -                   | 2000          | -           | -             | 500  |
| DLW21H      | 2.3        | 1.55 | 1.1       | 0.25 | -                   | 3000          | -           | -             | 500  |
| DLW31S      | 3.6        | 2.0  | 2.1       | 0.3  | -                   | 2000          | -           | -             | 500  |

(in mm)

## ■ Minimum Quantity and Dimensions of 12mm Width Embossed Tape

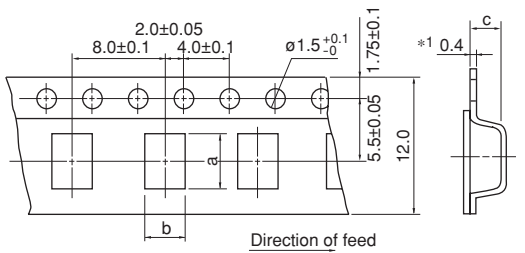

Dimension of the cavity is measured at the bottom side.

| Part Number | Dimensions |     |     | Minimum Qty. (pcs.) |             |      |
|-------------|------------|-----|-----|---------------------|-------------|------|
|             | a          | b   | c   | ø180mm Reel         | ø330mm Reel | Bulk |
| DLW43SH_XK  | 4.9        | 3.6 | 2.7 | 500                 | 2500        | 100  |
| DLW43SH_XP  | 4.9        | 3.6 | 2.9 | 500                 | 2500        | 100  |
| DLW5AH      | 5.4        | 4.1 | 4.4 | 400                 | 1500        | 100  |
| DLW5AT      | 5.4        | 4.1 | 2.7 | 700                 | 2500        | 100  |
| DLW5BS      | 5.5        | 5.4 | 4.7 | 400                 | 1500        | 100  |
| DLW5BT      | 5.5        | 5.5 | 2.7 | 700                 | 2500        | 100  |

(in mm)

"Minimum Quantity" means the number of units of each delivery or order. The quantity should be an integral multiple of the "Minimum Quantity."

⚠Note • Please read rating and ⚠CAUTION (for storage, operating, rating, soldering, mounting and handling) in this catalog to prevent smoking and/or burning, etc.  
• This catalog has only typical specifications. Therefore, please approve our product specifications or transact the approval sheet for product specifications before ordering.

Chip Ferrite Bead  
Chip EMIFIL®  
Packaging  
Chip Common Mode Choke Coil  
Block Type EMIFIL®  
Microwave Absorber



### Minimum Quantity and Dimensions of 24mm Width Embossed Tape

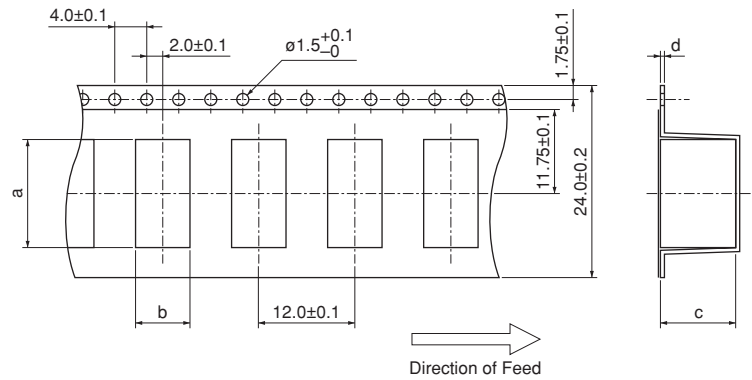

Dimension of the cavity is measured at the bottom side.

| Part Number | Dimensions |     |     |     | Minimum Qty. (pcs.) |             |      |
|-------------|------------|-----|-----|-----|---------------------|-------------|------|
|             | a          | b   | c   | d   | ø180mm Reel         | ø330mm Reel | Bulk |
| PLT10H      | 13.5       | 6.8 | 9.4 | 0.5 | 125                 | 500         | 50   |

(in mm)

⚠Note • Please read rating and ⚠CAUTION (for storage, operating, rating, soldering, mounting and handling) in this catalog to prevent smoking and/or burning, etc.  
• This catalog has only typical specifications. Therefore, please approve our product specifications or transact the approval sheet for product specifications before ordering.



### ●EKEMDL21AQ-KIT (Chip Common Mode Choke Coils)

| No. | Part Number   | Quantity (pcs.) | Common Mode Impedance (at 100MHz, 20 degrees C) | Rated Voltage (Vdc) | Rated Current (mA) |
|-----|---------------|-----------------|---|---------------------|--------------------|
| 1   | DLW21HN670SQ2 | 10              | 67Ω±25%   | 50                  | 330                |
| 2   | DLW21HN900SQ2 | 10              | 90Ω±25%   | 50                  | 330                |
| 3   | DLW21HN121SQ2 | 10              | 120Ω±25%  | 50                  | 280                |
| 4   | DLW21HN181SQ2 | 10              | 180Ω±25%  | 50                  | 250                |
| 5   | DLW21HN670HQ2 | 10              | 67Ω±25%   | 20                  | 240                |
| 6   | DLW21HN900HQ2 | 10              | 90Ω±25%   | 20                  | 220                |
| 7   | DLW21HN121HQ2 | 10              | 120Ω±25%  | 20                  | 200                |
| 8   | DLW21SN501SK2 | 10              | 500Ω±25%  | 50                  | 250                |
| 9   | DLW21SN670SQ2 | 10              | 67Ω±25%   | 50                  | 400                |
| 10  | DLW21SN900SQ2 | 10              | 90Ω±25%   | 50                  | 330                |
| 11  | DLW21SN121SQ2 | 10              | 120Ω±25%  | 50                  | 370                |
| 12  | DLW21SN181SQ2 | 10              | 180Ω±25%  | 50                  | 330                |
| 13  | DLW21SN261SQ2 | 10              | 260Ω±25%  | 50                  | 300                |
| 14  | DLW21SN371SQ2 | 10              | 370Ω±25%  | 50                  | 280                |
| 15  | DLW21SN670HQ2 | 10              | 67Ω±25%   | 20                  | 320                |
| 16  | DLW21SN900HQ2 | 10              | 90Ω±25%   | 20                  | 280                |
| 17  | DLW21SN121HQ2 | 10              | 120Ω±25%  | 20                  | 280                |
| 18  | DLW21SR670HQ2 | 10              | 67Ω±25%   | 20                  | 400                |
| 19  | DLW21SN181XQ2 | 10              | 180Ω±25%  | 20                  | 240                |
| 20  | DLW21SN261XQ2 | 10              | 260Ω±25%  | 20                  | 220                |
| 21  | DLW21SN491XQ2 | 10              | 490Ω±25%  | 20                  | 190                |
| 22  | DLP0NSC280HL2 | 10              | 28Ω±20%   | 5                   | 100                |
| 23  | DLP0NSN350HL2 | 10              | 35Ω±10Ω   | 5                   | 100                |
| 24  | DLP0NSN670HL2 | 10              | 67Ω±20%   | 5                   | 110                |
| 25  | DLP0NSN900HL2 | 10              | 90Ω±20%   | 5                   | 100                |
| 26  | DLP0NSN121HL2 | 10              | 120Ω±20%  | 5                   | 90                 |
| 27  | DLP0NSA070HL2 | 10              | 7Ω±2Ω   | 5                   | 100                |
| 28  | DLP0NSA150HL2 | 10              | 15Ω±5Ω  | 5                   | 100                |
| 29  | DLP0QSN600HL2 | 10              | 60Ω±25%   | 5                   | 50                 |
| 30  | DLP0QSA070HL2 | 10              | 7Ω±2Ω   | 5                   | 100                |
| 31  | DLP0QSA150HL2 | 10              | 15Ω±5Ω  | 5                   | 100                |
| 32  | DLP0QSA350HL2 | 10              | 35Ω±10Ω   | 5                   | 100                |
| 33  | DLP1NDN350HL4 | 10              | 35Ω±20%   | 5                   | 100                |
| 34  | DLP1NDN670HL4 | 10              | 67Ω±20%   | 5                   | 80                 |
| 35  | DLP1NDN900HL4 | 10              | 90Ω±20%   | 5                   | 60                 |
| 36  | DLP11SA350HL2 | 10              | 35Ω±20%   | 5                   | 170                |
| 37  | DLP11SA670HL2 | 10              | 67Ω±20%   | 5                   | 150                |
| 38  | DLP11SA900HL2 | 10              | 90Ω±20%   | 5                   | 150                |
| 39  | DLP11SN670SL2 | 10              | 67Ω±20%   | 5                   | 180                |
| 40  | DLP11SN121SL2 | 10              | 120Ω±20%  | 5                   | 140                |
| 41  | DLP11SN161SL2 | 10              | 160Ω±20%  | 5                   | 120                |
| 42  | DLP11SN900HL2 | 10              | 90Ω±20%   | 5                   | 150                |
| 43  | DLP11SN201HL2 | 10              | 200Ω±20%  | 5                   | 110                |
| 44  | DLP11SN241HL2 | 10              | 240Ω±20%  | 5                   | 100                |
| 45  | DLP11SN281HL2 | 10              | 280Ω±20%  | 5                   | 90                 |
| 46  | DLP11SN331HL2 | 10              | 330Ω±20%  | 5                   | 80                 |
| 47  | DLP11RB150UL2 | 10              | 15Ω±5Ω  | 5                   | 100                |
| 48  | DLP11RB400UL2 | 10              | 40Ω±10Ω   | 5                   | 100                |
| 49  | DLP11RN450UL2 | 10              | 45Ω±25%   | 5                   | 100                |
| 50  | DLP11TB800UL2 | 10              | 80Ω±25%   | 5                   | 100                |
| 51  | DLP2ADA350HL4 | 10              | 35Ω±20%   | 5                   | 150                |
| 52  | DLP2ADA670HL4 | 10              | 67Ω±20%   | 5                   | 130                |
| 53  | DLP2ADA900HL4 | 10              | 90Ω±20%   | 5                   | 120                |
| 54  | DLP2ADN670HL4 | 10              | 67Ω±20%   | 5                   | 140                |
| 55  | DLP2ADN900HL4 | 10              | 90Ω±20%   | 5                   | 130                |

Continued on the following page.

△Note • Please read rating and △CAUTION (for storage, operating, rating, soldering, mounting and handling) in this catalog to prevent smoking and/or burning, etc.  
 • This catalog has only typical specifications. Therefore, please approve our product specifications or transact the approval sheet for product specifications before ordering.



Continued from the preceding page.

| No. | Part Number   | Quantity (pcs.) | Common Mode Impedance (at 100MHz, 20 degrees C) | Rated Voltage (Vdc) | Rated Current (mA) |
|-----|---------------|-----------------|---|---------------------|--------------------|
| 56  | DLP2ADN121HL4 | 10              | 120Ω±20%  | 5                   | 120                |
| 57  | DLP2ADN161HL4 | 10              | 160Ω±20%  | 5                   | 100                |
| 58  | DLP2ADN201HL4 | 10              | 200Ω±20%  | 5                   | 90                 |
| 59  | DLP2ADN241HL4 | 10              | 240Ω±20%  | 5                   | 80                 |
| 60  | DLP2ADN281HL4 | 10              | 280Ω±20%  | 5                   | 80                 |
| 61  | DLM11SN450HY2 | 10              | 45Ω±25%   | 5                   | 100                |
| 62  | DLM11SN900HY2 | 10              | 90Ω±25%   | 5                   | 100                |

● EKEMDCC5AF-KIT (Chip Common Mode Choke Coils for DC Power Lines / SMD Block Type EMIFIL® for Power Lines)

| No. | Part Number   | Quantity (pcs.) | Common Mode Impedance (at 100MHz, 20 degrees C) | Rated Voltage (Vdc) | Rated Current (mA) |
|-----|---------------|-----------------|---|---------------------|--------------------|
| 1   | DLW5AHN402SQ2 | 5               | 4000Ω (Typ.)                                    | 50                  | 200                |
| 2   | DLW5ATN111SQ2 | 5               | 110Ω (Typ.)                                     | 50                  | 5000               |
| 3   | DLW5ATN401SQ2 | 5               | 400Ω (Typ.)                                     | 50                  | 2000               |
| 4   | DLW5ATN501SQ2 | 5               | 500Ω (Typ.)                                     | 50                  | 1500               |
| 5   | DLW5ATN851SQ2 | 5               | 850Ω (Typ.)                                     | 50                  | 1500               |
| 6   | DLW5ATN272SQ2 | 5               | 2700Ω (Typ.)                                    | 50                  | 1000               |
| 7   | DLW5BSM501TQ2 | 5               | 500Ω (Typ.)                                     | 50                  | 1000               |
| 8   | DLW5BSM601TQ2 | 5               | 600Ω (Typ.)                                     | 50                  | 1400               |
| 9   | DLW5BSM801TQ2 | 5               | 800Ω (Typ.)                                     | 50                  | 2000               |
| 10  | DLW5BSM191SQ2 | 5               | 190Ω (Typ.)                                     | 50                  | 5000               |
| 11  | DLW5BSM351SQ2 | 5               | 350Ω (Typ.)                                     | 50                  | 2000               |
| 12  | DLW5BSM102SQ2 | 5               | 1000Ω (Typ.)                                    | 50                  | 1500               |
| 13  | DLW5BSM152SQ2 | 5               | 1500Ω (Typ.)                                    | 50                  | 1000               |
| 14  | DLW5BSM302SQ2 | 5               | 3000Ω (Typ.)                                    | 50                  | 500                |
| 15  | DLW5BTM101SQ2 | 5               | 100Ω (Typ.)                                     | 50                  | 6000               |
| 16  | DLW5BTM251SQ2 | 5               | 250Ω (Typ.)                                     | 50                  | 5000               |
| 17  | DLW5BTM501SQ2 | 5               | 500Ω (Typ.)                                     | 50                  | 4000               |
| 18  | DLW5BTM102SQ2 | 5               | 1000Ω (Typ.)                                    | 50                  | 2000               |
| 19  | DLW5BTM142SQ2 | 5               | 1400Ω (Typ.)                                    | 50                  | 1500               |

● EKEMDL5AAC-KIT (Chip Common Mode Choke Coils for DC Power Lines / SMD Block Type EMIFIL® for Power Lines / 105 degree C available Type)

| No. | Part Number   | Quantity (pcs.) | Common Mode Impedance (at 100MHz, 20 degrees C) | Rated Voltage (Vdc) | Rated Current (mA) |
|-----|---------------|-----------------|---|---------------------|--------------------|
| 1   | DLW5ATN500MQ2 | 5               | 50Ω (Typ.)                                      | 50                  | 6000               |
| 2   | DLW5ATN151MQ2 | 5               | 150Ω (Typ.)                                     | 50                  | 5000               |
| 3   | DLW5ATN331MQ2 | 5               | 330Ω (Typ.)                                     | 50                  | 4000               |
| 4   | DLW5ATN501MQ2 | 5               | 500Ω (Typ.)                                     | 50                  | 2500               |
| 5   | DLW5ATN112MQ2 | 5               | 1100Ω (Typ.)                                    | 50                  | 2000               |
| 6   | DLW5ATN111TQ2 | 5               | 110Ω (Typ.)                                     | 50                  | 5000               |
| 7   | DLW5ATN231TQ2 | 5               | 230Ω (Typ.)                                     | 50                  | 4000               |
| 8   | DLW5ATN401TQ2 | 5               | 400Ω (Typ.)                                     | 50                  | 2500               |
| 9   | DLW5ATN501TQ2 | 5               | 500Ω (Typ.)                                     | 50                  | 2000               |
| 10  | DLW5BTM101TQ2 | 5               | 100Ω (Typ.)                                     | 50                  | 6000               |
| 11  | DLW5BTM251TQ2 | 5               | 250Ω (Typ.)                                     | 50                  | 5000               |
| 12  | DLW5BTM501TQ2 | 5               | 500Ω (Typ.)                                     | 50                  | 4000               |
| 13  | DLW5BTM102TQ2 | 5               | 1000Ω (Typ.)                                    | 50                  | 2500               |
| 14  | DLW5BTM142TQ2 | 5               | 1400Ω (Typ.)                                    | 50                  | 2000               |
| 15  | DLW5BSM501TQ2 | 5               | 500Ω (Typ.)                                     | 50                  | 1000               |
| 16  | DLW5BSM601TQ2 | 5               | 600Ω (Typ.)                                     | 50                  | 1400               |
| 17  | DLW5BSM801TQ2 | 5               | 800Ω (Typ.)                                     | 50                  | 2000               |

△Note • Please read rating and △CAUTION (for storage, operating, rating, soldering, mounting and handling) in this catalog to prevent smoking and/or burning, etc.  
• This catalog has only typical specifications. Therefore, please approve our product specifications or transact the approval sheet for product specifications before ordering.



●EKEPBLCKAD-KIT

| No. | Part Number     | Quantity (pcs.) | Common Mode Impedance (at 10MHz, 20 degrees C) | Rated Voltage (Vdc) | Rated Current (A) |
|-----|-----------------|-----------------|--|---------------------|-------------------|
| 1   | PLT10HH450180PN | 2               | 45Ω (Typ.)                                     | 300                 | 18                |
| 2   | PLT10HH101150PN | 2               | 100Ω (Typ.)                                    | 300                 | 15                |
| 3   | PLT10HH401100PN | 2               | 400Ω (Typ.)                                    | 100                 | 10                |
| 4   | PLT10HH501100PN | 2               | 500Ω (Typ.)                                    | 100                 | 10                |
| 5   | PLT10HH9016R0PN | 2               | 900Ω (Typ.)                                    | 100                 | 6                 |
| 6   | PLT10HH1026R0PN | 2               | 1000Ω (Typ.)                                   | 100                 | 6                 |

| No. | Part Number | Quantity (pcs.) | Insertion Loss             | Rated Voltage (Vdc) | Rated Current (A) |
|-----|-------------|-----------------|----------------------------|---------------------|-------------------|
| 7   | BNX002-01   | 1               | 1MHz to 1GHz : 40dB min.   | 50                  | 10                |
| 8   | BNX003-01   | 1               | 5MHz to 1GHz : 40dB min.   | 150                 | 10                |
| 9   | BNX005-01   | 1               | 1MHz to 1GHz : 40dB min.   | 50                  | 15                |
| 10  | BNX012-01   | 1               | 1MHz to 1GHz : 40dB min.   | 50                  | 15                |
| 11  | BNX016-01   | 1               | 100kHz to 1GHz : 40dB min. | 25                  | 15                |
| 12  | BNX022-01   | 2               | 1MHz to 1GHz : 35dB min.   | 50                  | 10                |
| 13  | BNX023-01   | 2               | 1MHz to 1GHz : 35dB min.   | 100                 | 15                |
| 14  | BNX024H01   | 2               | 100kHz to 1GHz : 35dB min. | 50                  | 15                |
| 15  | BNX025H01   | 2               | 50kHz to 1GHz : 35dB min.  | 25                  | 15                |

△Note • Please read rating and △CAUTION (for storage, operating, rating, soldering, mounting and handling) in this catalog to prevent smoking and/or burning, etc.  
 • This catalog has only typical specifications. Therefore, please approve our product specifications or transact the approval sheet for product specifications before ordering.

Chip Ferrite Bead

Chip EMIFIL®

Design Kits  
Chip Common Mode Choke Coil

Block Type EMIFIL®

Microwave Absorber

# BNX

## Block Type EMIFIL®

|                              |     |
|------------------------------|-----|
| Series Line Up .....         | 218 |
| Function Example .....       | 218 |
| Product Detail .....         | 221 |
| ⚠Caution/Notice .....        | 225 |
| Soldering and Mounting ..... | 227 |
| Packaging .....              | 231 |
| Design Kits .....            | 232 |

Chip Ferrite Bead

Chip EMIFIL®

Chip Common Mode Choke Coil

Block Type EMIFIL®

Microwave Absorber

⚠Note • Please read rating and ⚠CAUTION (for storage, operating, rating, soldering, mounting and handling) in this catalog to prevent smoking and/or burning, etc.  
• This catalog has only typical specifications. Therefore, please approve our product specifications or transact the approval sheet for product specifications before ordering.

| Type  | Part Number | Thickness (mm) | Rated Voltage | Effective Frequency Range | Rated Current | $K_{it}$ | $\geq 3A$ | $F_{low}$      | $R_{eF_{low}}$ |
|---|-------------|----------------|---------------|---------------------------|---------------|----------|-----------|----------------|----------------|
| SMD Type<br>for Power Lines<br><i>p221</i>              | BNX022-01   | 3.1            | 50Vdc         | 1MHz to 1GHz:35dB min.    | 10A           | $K_{it}$ | $\geq 3A$ | $R_{eF_{low}}$ | $R_{eF_{low}}$ |
|   | BNX023-01   | 3.1            | 100Vdc        | 1MHz to 1GHz:35dB min.    | 15A           | $K_{it}$ | $\geq 3A$ | $R_{eF_{low}}$ | $R_{eF_{low}}$ |
|   | BNX024H01   | 3.5            | 50Vdc         | 100kHz to 1GHz:35dB min.  | 15A           | $K_{it}$ | $\geq 3A$ | $R_{eF_{low}}$ | $R_{eF_{low}}$ |
|   | BNX025H01   | 3.5            | 25Vdc         | 50kHz to 1GHz:35dB min.   | 15A           | $K_{it}$ | $\geq 3A$ | $R_{eF_{low}}$ | $R_{eF_{low}}$ |
| Lead Type<br>for Power Lines<br><i>p223</i>             | BNX002-01   | 18.0           | 50Vdc         | 1MHz to 1GHz:40dB min.    | 10A           | $K_{it}$ | $\geq 3A$ | $F_{low}$      |                |
|   | BNX003-01   | 18.0           | 150Vdc        | 5MHz to 1GHz:40dB min.    | 10A           | $K_{it}$ | $\geq 3A$ | $F_{low}$      |                |
|   | BNX005-01   | 18.5           | 50Vdc         | 1MHz to 1GHz:40dB min.    | 15A           | $K_{it}$ | $\geq 3A$ | $F_{low}$      |                |
| Lead Type<br>Low Profile for Power Lines<br><i>p224</i> | BNX012-01   | 8.0            | 50Vdc         | 1MHz to 1GHz:40dB min.    | 15A           | $K_{it}$ | $\geq 3A$ | $F_{low}$      |                |
|   | BNX016-01   | 8.0            | 25Vdc         | 100kHz to 1GHz:40dB min.  | 15A           | $K_{it}$ | $\geq 3A$ | $F_{low}$      |                |

## Suppression of Radiation Noise from Power Line Cable

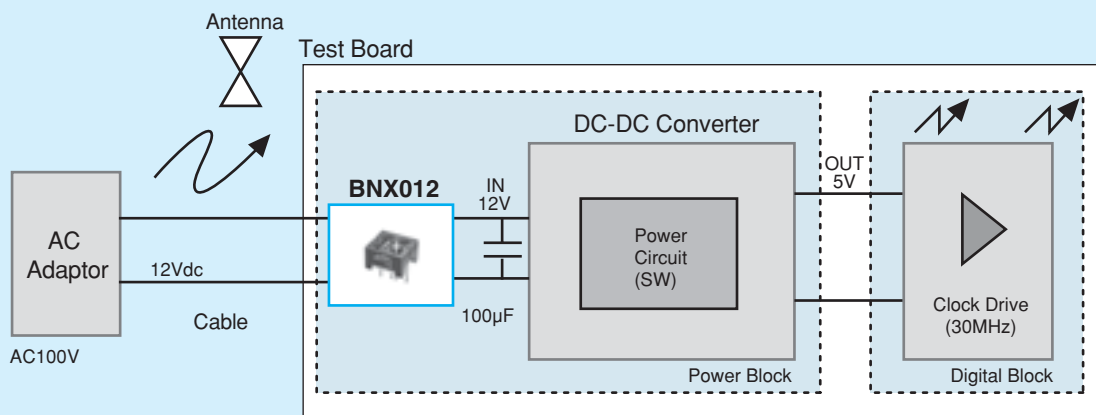

### Test Result

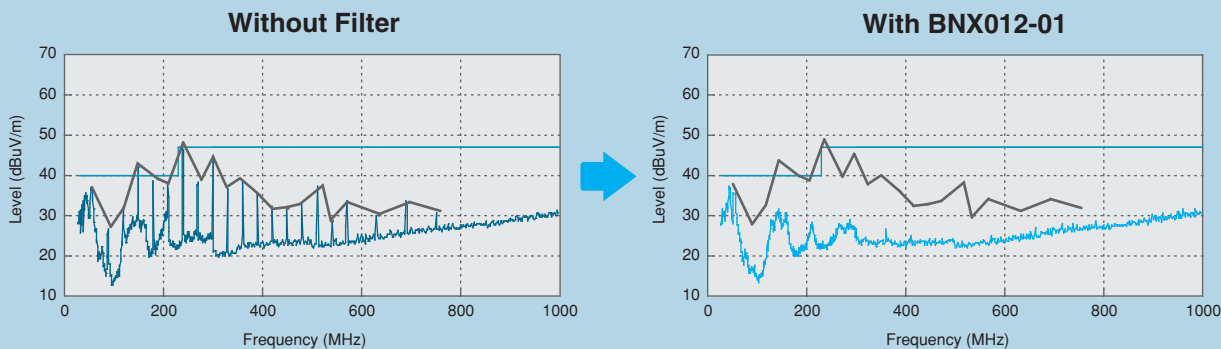

△Note • Please read rating and △CAUTION (for storage, operating, rating, soldering, mounting and handling) in this catalog to prevent smoking and/or burning, etc.  
• This catalog has only typical specifications. Therefore, please approve our product specifications or transact the approval sheet for product specifications before ordering.

### Impulse Noise Countermeasure

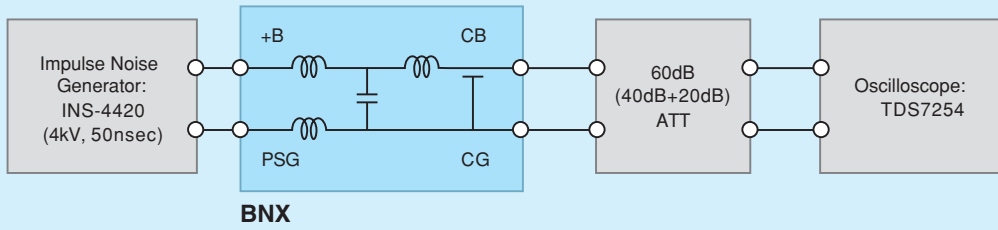

#### Without Filter

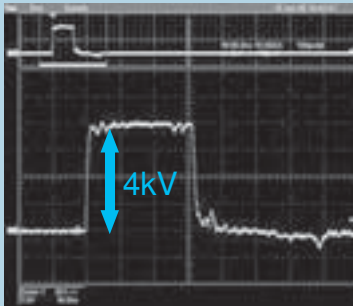

Applied Impulse Voltage: 4kV/50nS  
Y-AXIS: 1kV/div

#### With Filter



BNX002-01



BNX012-01

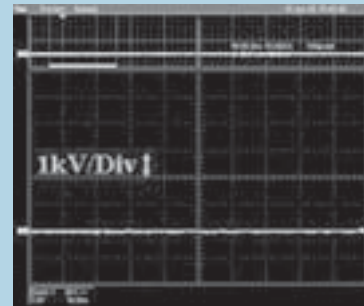

BNX022-01

### ESD Countermeasure

ESD Waveform Comparison

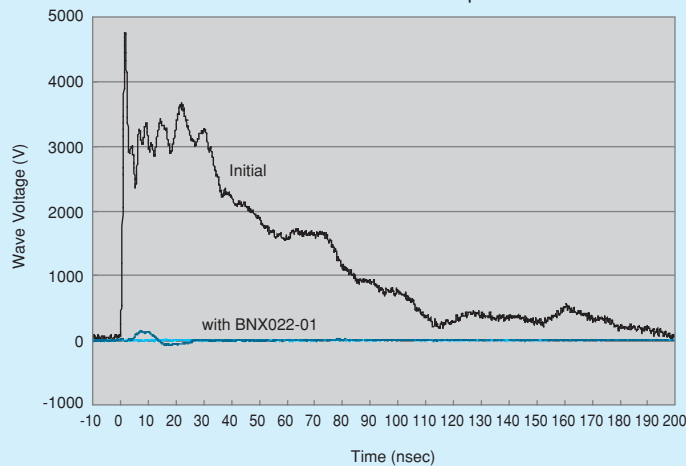

⚠Note • Please read rating and ⚠CAUTION (for storage, operating, rating, soldering, mounting and handling) in this catalog to prevent smoking and/or burning, etc.  
• This catalog has only typical specifications. Therefore, please approve our product specifications or transact the approval sheet for product specifications before ordering.

## Suppression of Ripple Noise of DC Side in the Switching Power Supply

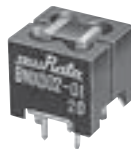

Test Circuit

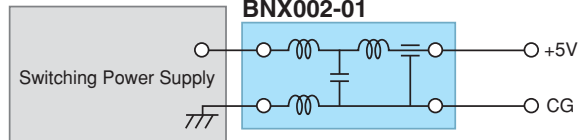

| Type of Filter         | EMI Suppression Effect / Description    |  |
|------------------------|---|--|
| Without Filter         | <p>+5.0V→<br/>50μs/div<br/>0.2V/div</p> | There is high frequency noise of 0.5V maximum. |
| When BNX002-01 is used | <p>+5.0V→<br/>50μs/div<br/>0.2V/div</p> | BNX002-01 can suppress most of the noise.      |

## Example of Impulse Noise Suppression

| Type of Filter      | EMI Suppression Effect   |  |
|---------------------|--|--|
| Without Filter      | <p>Impulse Noise<br/>2000V/50ns</p> <p>Y-axis: 500V/div<br/>X-axis: 10ns/sec</p> |  |
| When BNX002 is used | <p>Y-axis: 500V/div<br/>X-axis: 10ns/sec</p>                                     |  |

△Note • Please read rating and △CAUTION (for storage, operating, rating, soldering, mounting and handling) in this catalog to prevent smoking and/or burning, etc.  
• This catalog has only typical specifications. Therefore, please approve our product specifications or transact the approval sheet for product specifications before ordering.

# BNX02□ Series



## SMD package of block type EMIFIL®.

**BNX022/BNX023**



**■ Dimensions**

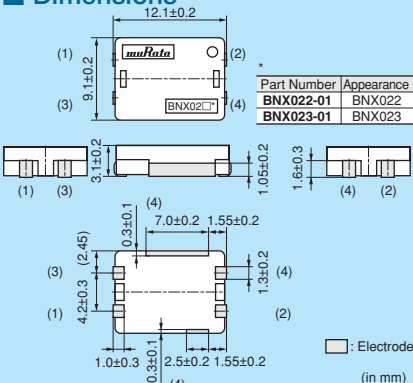

| Part Number | Appearance |
|-------------|------------|
| BNX022-01   | BNX022     |
| BNX023-01   | BNX023     |

□: Electrode (in mm)

**■ Equivalent Circuit**

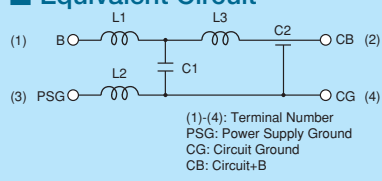

(1)-(4): Terminal Number  
 PSG: Power Supply Ground  
 CG: Circuit Ground  
 CB: Circuit+B

**■ Packaging**

| Code | Packaging                | Minimum Quantity |
|------|--------------------------|------------------|
| L    | 180mm Reel Embossed Tape | 400              |
| K    | 330mm Reel Embossed Tape | 1500             |
| B    | Bulk(Bag)                | 100              |

**BNX024H/BNX025H**



**■ Dimensions**

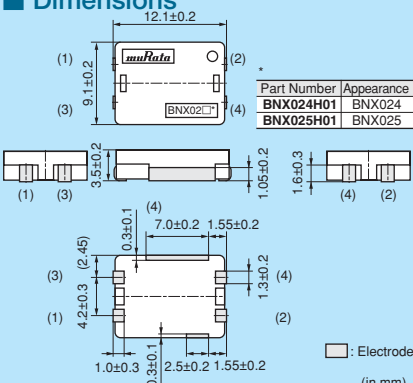

| Part Number | Appearance |
|-------------|------------|
| BNX024H01   | BNX024     |
| BNX025H01   | BNX025     |

□: Electrode (in mm)

**■ Equivalent Circuit**

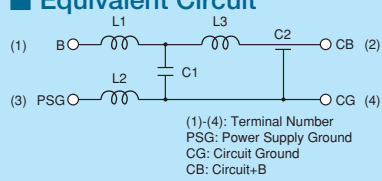

(1)-(4): Terminal Number  
 PSG: Power Supply Ground  
 CG: Circuit Ground  
 CB: Circuit+B

**■ Packaging**

| Code | Packaging                | Minimum Quantity |
|------|--------------------------|------------------|
| L    | 180mm Reel Embossed Tape | 400              |
| K    | 330mm Reel Embossed Tape | 1500             |
| B    | Bulk(Bag)                | 100              |

Refer to pages from p.227 to p.228 for mounting information.

**■ Rated Value (□: packaging code)**

| Part Number | Rated Voltage | Withstand Voltage | Rated Current | Insulation Resistance (min.) | Insertion Loss (Line impedance=50 ohm) | Kit     |
|-------------|---------------|-------------------|---------------|------------------------------|--|---------|
| BNX022-01□  | 50Vdc         | 125Vdc            | 10A           | 500M ohm                     | 1MHz to 1GHz:35dB min.                 | Kit ≥3A |
| BNX023-01□  | 100Vdc        | 250Vdc            | 15A           | 500M ohm                     | 1MHz to 1GHz:35dB min.                 | Kit ≥3A |
| BNX024H01□  | 50Vdc         | 125Vdc            | 15A           | 100M ohm                     | 100kHz to 1GHz:35dB min.               | Kit ≥3A |
| BNX025H01□  | 25Vdc         | 62.5Vdc           | 15A           | 50M ohm                      | 50kHz to 1GHz:35dB min.                | Kit ≥3A |

Operating Temperature Range: -40°C to +125°C (BNX022/BNX023), -55°C to +125°C (BNX024H/BNX025H)

**■ Insertion Loss Characteristics**

BNX022/023

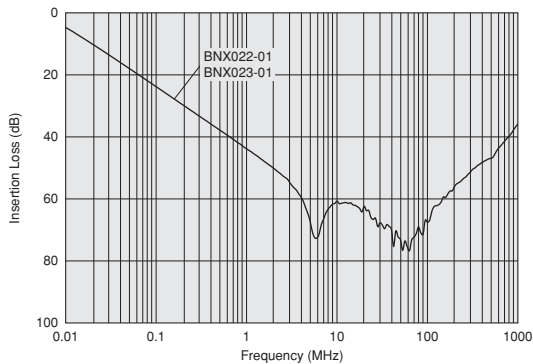

BNX024H01

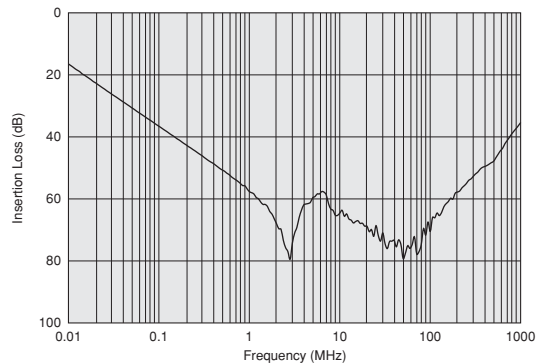

Continued on the following page. ↗

⚠Note • Please read rating and ⚠CAUTION (for storage, operating, rating, soldering, mounting and handling) in this catalog to prevent smoking and/or burning, etc.  
 • This catalog has only typical specifications. Therefore, please approve our product specifications or transact the approval sheet for product specifications before ordering.

**■ Insertion Loss Characteristics**  
BNX025H01

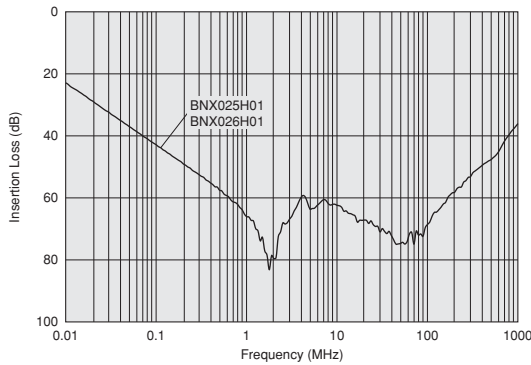

**■ Notice (Rating)**

In operating temperature exceeding +85°C, derating of current is necessary for BNX022 series. Please apply the derating curve shown in chart according to the operating temperature.

In operating temperature exceeding +85°C, derating of current is necessary for BNX023 series. Please apply the derating curve shown in chart according to the operating temperature.

Derating of Rated Current

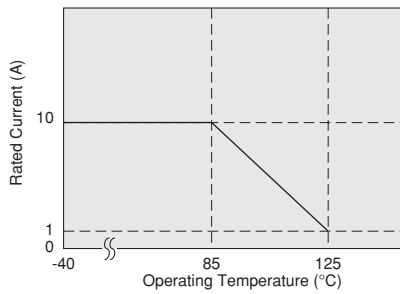

Derating of Rated Current

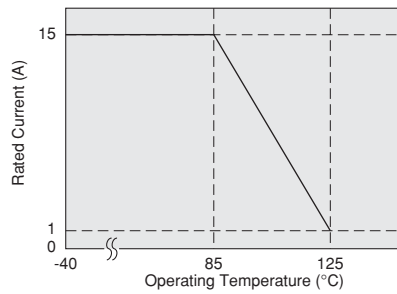

In operating temperature exceeding +85°C, derating of current is necessary for BNX024H/025H series. Please apply the derating curve shown in chart according to the operating temperature.

Derating of Rated Current

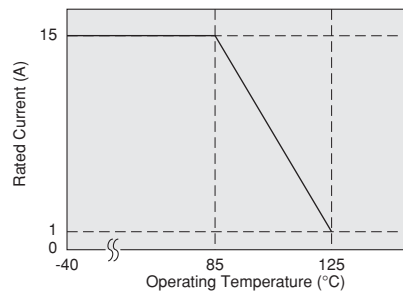

⚠Note • Please read rating and ⚠CAUTION (for storage, operating, rating, soldering, mounting and handling) in this catalog to prevent smoking and/or burning, etc.  
• This catalog has only typical specifications. Therefore, please approve our product specifications or transact the approval sheet for product specifications before ordering.

Chip Ferrite Bead  
Chip EMIFIL®  
Chip Common Mode Choke Coil  
Block Type EMIFIL® Power Lines Type  
Microwave Absorber



# BNX00□ Series



Large insertion loss from several hundred kHz to several GHz.

**BNX002/BNX003**



**■ Dimensions**

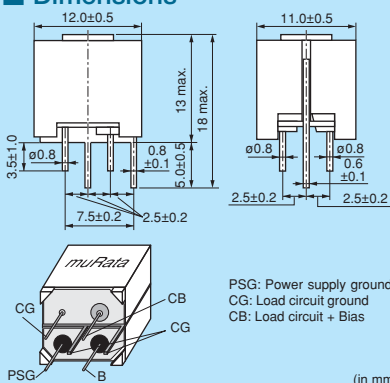

PSG: Power supply ground  
CG: Load circuit ground  
CB: Load circuit + Bias

(in mm)

**■ Equivalent Circuit**

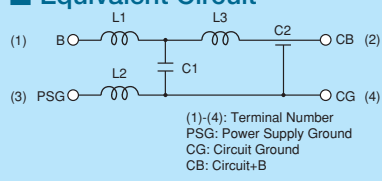

(1)-(4): Terminal Number  
PSG: Power Supply Ground  
CG: Circuit Ground  
CB: Circuit+B

**■ Packaging**

| Code | Packaging | Minimum Quantity |
|------|-----------|------------------|
| -    | Box       | 100              |

**BNX005**



**■ Dimensions**

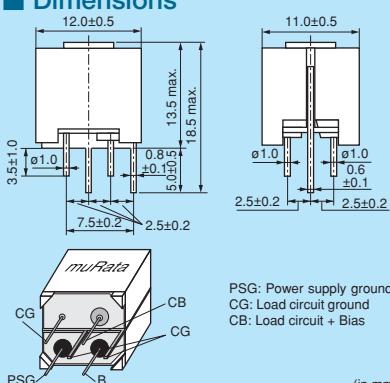

PSG: Power supply ground  
CG: Load circuit ground  
CB: Load circuit + Bias

(in mm)

**■ Equivalent Circuit**

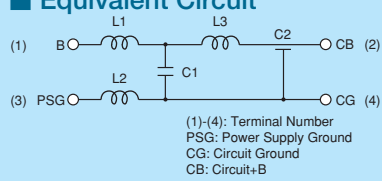

(1)-(4): Terminal Number  
PSG: Power Supply Ground  
CG: Circuit Ground  
CB: Circuit+B

**■ Packaging**

| Code | Packaging | Minimum Quantity |
|------|-----------|------------------|
| -    | Box       | 100              |

Refer to pages from p.229 to p.230 for mounting information.

**■ Rated Value**

| Part Number | Rated Voltage | Withstand Voltage | Rated Current | Insulation Resistance (min.) | Insertion Loss (Line impedance=50 ohm) |     |
|-------------|---------------|-------------------|---------------|------------------------------|--|-----|
| BNX002-01   | 50Vdc         | 125Vdc            | 10A           | 100M ohm                     | 1MHz to 1GHz:40dB min.                 | Kit |
| BNX003-01   | 150Vdc        | 375Vdc            | 10A           | 100M ohm                     | 5MHz to 1GHz:40dB min.                 | Kit |
| BNX005-01   | 50Vdc         | 125Vdc            | 15A           | 100M ohm                     | 1MHz to 1GHz:40dB min.                 | Kit |

Operating Temperature Range: -30°C to +85°C

**■ Insertion Loss Characteristics**

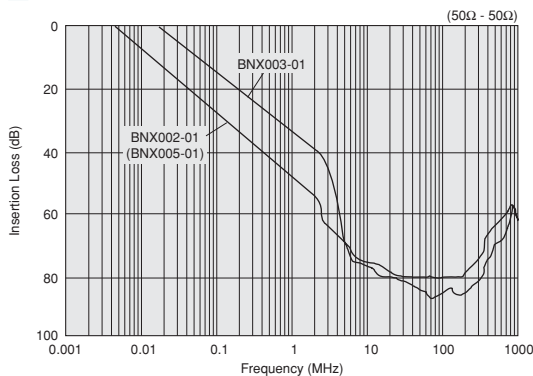

△Note • Please read rating and △CAUTION (for storage, operating, rating, soldering, mounting and handling) in this catalog to prevent smoking and/or burning, etc.  
• This catalog has only typical specifications. Therefore, please approve our product specifications or transact the approval sheet for product specifications before ordering.

# BNX01□ Series



Low profile version of BNX series.



### Dimensions

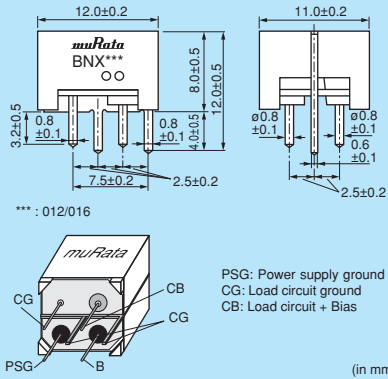

### Equivalent Circuit

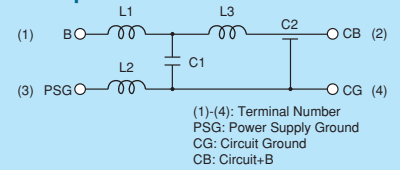

### Packaging

| Code | Packaging | Minimum Quantity |
|------|-----------|------------------|
| -    | Box       | 150              |

Refer to pages from p.229 to p.230 for mounting information.

### Rated Value

| Part Number | Rated Voltage | Withstand Voltage | Rated Current | Insulation Resistance (min.) | Insertion Loss (Line impedance=50 ohm) |         |
|-------------|---------------|-------------------|---------------|------------------------------|--|---------|
| BNX012-01   | 50Vdc         | 125Vdc            | 15A           | 500M ohm                     | 1MHz to 1GHz:40dB min.                 | Kit ≥3A |
| BNX016-01   | 25Vdc         | 62.5Vdc           | 15A           | 50M ohm                      | 100kHz to 1GHz:40dB min.               | Kit ≥3A |

Operating Temperature Range: -40°C to +125°C

### Insertion Loss Characteristics

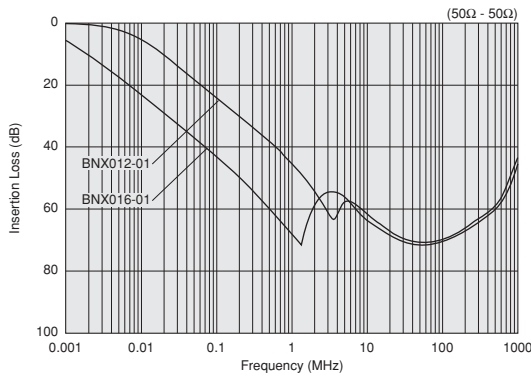

### Notice (Rating)

In operating temperature exceeding +85°C, derating of current is necessary for BNX01□ series. Please apply the derating curve shown in chart according to the operating temperature.

#### Derating of Rated Current

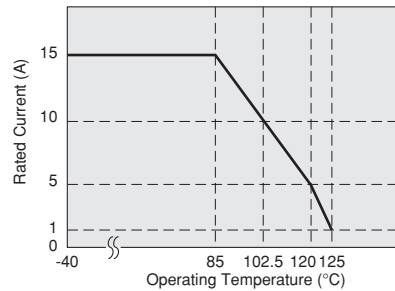

#### ● Connecting ± power line

In case of using ± power line, please connect to each terminal as shown.

|                     | Power Supply (BNX Input) | BNX | Circuit (BNX Output)  |
|---------------------|--------------------------|-----|-----------------------|
| Power Supply +Bias  | B                        | CB  | - Load Circuit +Bias  |
| Power Supply Ground | PSG                      | CG  | - Load Circuit Ground |
| Power Supply -Bias  | B                        | CB  | - Load Circuit -Bias  |
| Power Supply Ground | PSG                      | CG  | - Load Circuit Ground |

△Note • Please read rating and △CAUTION (for storage, operating, rating, soldering, mounting and handling) in this catalog to prevent smoking and/or burning, etc.  
• This catalog has only typical specifications. Therefore, please approve our product specifications or transact the approval sheet for product specifications before ordering.

Chip Ferrite Bead  
Chip EMIFIL®  
Chip Common Mode Choke Coil  
Block Type EMIFIL® Power Lines Type  
Microwave Absorber

⚠ Caution

● Rating

Do not use products beyond the rated current and rated voltage as this may create excessive heat and deteriorate the insulation resistance.

Notice

● Storage and Operating Conditions

<Operating Environment>

Do not use products in a chemical atmosphere such as chlorine gas, acid or sulfide gas.

Do not use products in the environment close to the organic solvent.

<Storage and Handling Requirements>

1. Storage Period

BNX series should be used within 12 months.  
Solderability should be checked if this period is exceeded.

2. Storage Conditions

- (1) Storage temperature: -10 to +40°C  
Relative humidity: 15 to 85%  
Avoid sudden changes in temperature and humidity.
- (2) Do not store products in a chemical atmosphere such as chlorine gas, acid or sulfide gas.

● Notice (Soldering and Mounting)

1. Cleaning

Do not clean BNX series (SMD Type).  
Before cleaning, please contact Murata engineering.

2. Soldering

Reliability decreases with improper soldering methods.  
Please solder by the standard soldering conditions shown in mounting information.

3. Other

Noise suppression levels resulting from Murata's EMI suppression filters EMIFIL<sup>®</sup> may vary, depending on the circuits and ICs used, type of noise, mounting pattern, mounting location, and other operating conditions. Be sure to check and confirm in advance the noise suppression effect of each filter, in actual circuits, etc. before applying the filter in a commercial-purpose equipment design.

● Handling

1. Resin Coating

Using resin for coating/molding products may affect the products performance.

So please pay careful attention in selecting resin. Prior to use, please make the reliability evaluation with the product mounted in your application set.

2. Handling of a Substrate (for BNX02□)

After mounting products on a substrate, do not apply any stress to the product caused by bending or twisting to the substrate when cropping the substrate, inserting and removing a connector from the substrate or tightening screw to the substrate. Excessive mechanical stress may cause cracking in the Product.

Bending

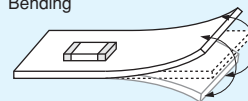

Twisting

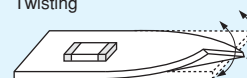

⚠ Note • Please read rating and ⚠ CAUTION (for storage, operating, rating, soldering, mounting and handling) in this catalog to prevent smoking and/or burning, etc.  
• This catalog has only typical specifications. Therefore, please approve our product specifications or transact the approval sheet for product specifications before ordering.

## ⚠ Caution

## ● Rating

Do not use products beyond the rated current and rated voltage as this may create excessive heat and deteriorate the insulation resistance.

## Notice

## ● Storage and Operating Conditions

<Operating Environment>

1. Do not use products in a chemical atmosphere such as chlorine gas, acid or sulfide gas.
2. Do not use products near water, oil or organic solvents.

<Storage and Handling Requirements>

1. Storage Period  
BNX Series should be used within 12 months.  
Solderability should be checked if this period is exceeded.
2. Storage Conditions
  - (1) Storage temperature: -10 to +40°C  
Relative humidity: 15 to 85%  
Avoid sudden changes in temperature and humidity.
  - (2) Do not store products in a chemical atmosphere such as chlorine gas, acid or sulfide gas.

## ● Notice (Soldering and Mounting)

1. Cleaning  
Failure and degradation of a product are caused by the cleaning method. When you clean in conditions that are not in mounting information, please contact Murata engineering.
2. Soldering  
Reliability decreases with improper soldering methods. Please solder by the standard soldering conditions shown in mounting information.
3. Other  
Noise suppression levels resulting from Murata's EMI suppression filters "EMIFIL" may vary, depending on the circuits and ICs used, type of noise, mounting pattern, lead wire length, mounting location, and other operating conditions. Be sure to check and confirm in advance the noise suppression effect of each filter, in actual circuits, etc. before applying the filter in a commercial-purpose equipment design.

## ● Notice (Appearance)

Although some part of the product surface seems to be white in some cases, do not care because it is the result of waxing process for humidity resistance improvement. This wax does not make bad affection to mechanical or electrical performance, reliability of the product.

⚠ Note • Please read rating and ⚠ CAUTION (for storage, operating, rating, soldering, mounting and handling) in this catalog to prevent smoking and/or burning, etc.  
• This catalog has only typical specifications. Therefore, please approve our product specifications or transact the approval sheet for product specifications before ordering.

## 1. Standard Land Pattern Dimensions

- Land Pattern + Solder Resist
  - Land Pattern
  - Solder Resist
  - Through Hole
- (in mm)

**BNX022**  
**BNX023**  
**BNX024**  
**BNX025**

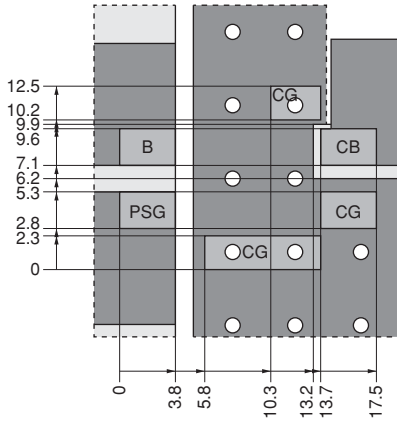

- (1) A double-sided print board (or multilayer board) as shown in the left figure is designed, and please apply a soldering Cu electrode with a product electrode to a "Land Pattern", apply resist to a "Land Pattern + Solder Resist" at Cu electrode.
- (2) This product is designed to meet large current. Please design PCB pattern which is connected to this product not to become too hot by applied large current.
- (3) Please drop CG on a ground electrode on the back layer (the same also in a multilayer case) by the through hole. And a surface to ground electrode layer may also take a large area as much as possible.
- (4) It is recommended to use a double-sided printed circuit board with BNX mounting on one side and the ground pattern on the other in order to maximize filtering performance, multiple feed through holes are required to maximize the BNX's connection to ground.
- (5) The ground pattern should be designed to be as large as possible to achieve maximum filtering performance.

### ● PCB Warping (for BNX02□)

PCB should be designed so that products are not subjected to the mechanical stress caused by warping the board.

Products should be located in the sideways direction (Length: a-b) to the mechanical stress.

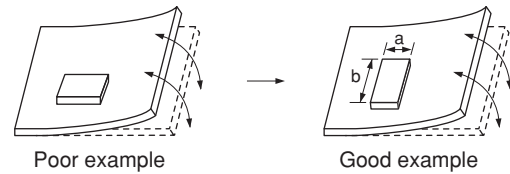

## 2. Solder Paste Printing and Adhesive Application

When reflow soldering the block type EMIFIL<sup>®</sup>, the printing must be conducted in accordance with the following cream solder printing conditions.

If too much solder is applied, the chip will be prone to

damage by mechanical and thermal stress from the PCB and may crack.

Standard land dimensions should be used for resist and copper foil patterns.

| Series   | Solder Paste Printing                                      | Adhesive Application   |
|--|--|--|
| <p><b>BNX022</b><br/><b>BNX023</b><br/><b>BNX024</b><br/><b>BNX025</b></p> | <p>●Guideline of solder paste thickness:<br/>150-200μm</p> | <div style="border: 1px solid black; height: 150px; width: 100%;"></div> |

⚠Note • Please read rating and ⚠CAUTION (for storage, operating, rating, soldering, mounting and handling) in this catalog to prevent smoking and/or burning, etc.  
• This catalog has only typical specifications. Therefore, please approve our product specifications or transact the approval sheet for product specifications before ordering.

**3. Standard Soldering Conditions**

(1) Soldering Methods

Use reflow soldering methods only.  
 Use standard soldering conditions when soldering block type EMIFIL® SMD type.  
 In cases where several different parts are soldered, each having different soldering conditions, use those conditions requiring the least heat and minimum time.

Solder: Use Sn-3.0Ag-0.5Cu solder. Use of Sn-Zn based solder will deteriorate performance of products.

Flux:

- Use Rosin-based flux.  
 In case of using RA type solder, products should be cleaned completely with no residual flux.
- Do not use strong acidic flux (with chlorine content exceeding 0.20wt%)
- Do not use water-soluble flux.

For additional mounting methods, please contact Murata.

(2) Soldering Profile

- Reflow Soldering Profile (Sn-3.0Ag-0.5Cu solder)

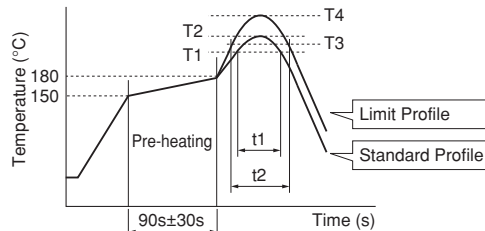

| Series                    | Standard Profile |            |                       |                 | Limit Profile |            |                       |                 |
|---------------------------|------------------|------------|-----------------------|-----------------|---------------|------------|-----------------------|-----------------|
|                           | Heating          |            | Peak Temperature (T2) | Cycle of Reflow | Heating       |            | Peak Temperature (T4) | Cycle of Reflow |
|                           | Temp. (T1)       | Time. (t1) |                       |                 | Temp. (T3)    | Time. (t2) |                       |                 |
| <b>BNX022/023/024/025</b> | 220°C min.       | 30 to 60s  | 250±3°C               | 2 times max.    | 230°C min.    | 60s max.   | 260°C/10s             | 2 times max.    |

(3) Reworking with Solder Iron

The following conditions must be strictly followed when using a soldering iron.  
 Pre-heating: 150°C 60s min.  
 Soldering iron power output: 100W max.  
 Temperature of soldering iron tip / Soldering time / Times:  
 450°C max. / 5s max. / 2 time

Do not allow the tip of the soldering iron to directly contact the chip.  
 For additional methods of reworking with a soldering iron, please contact Murata engineering.

**4. Cleaning**

Do not clean BNX022/023/024/025 series. In case of cleaning, please contact Murata engineering.

△Note • Please read rating and △CAUTION (for storage, operating, rating, soldering, mounting and handling) in this catalog to prevent smoking and/or burning, etc.  
 • This catalog has only typical specifications. Therefore, please approve our product specifications or transact the approval sheet for product specifications before ordering.

Chip Ferrite Bead  
 Chip EMIFIL®  
 Chip Common Mode Choke Coil  
 Soldering and Mounting Block Type EMIFIL®  
 Microwave Absorber

## 1. Mounting Hole

■ Mounting holes should be designed as specified below.

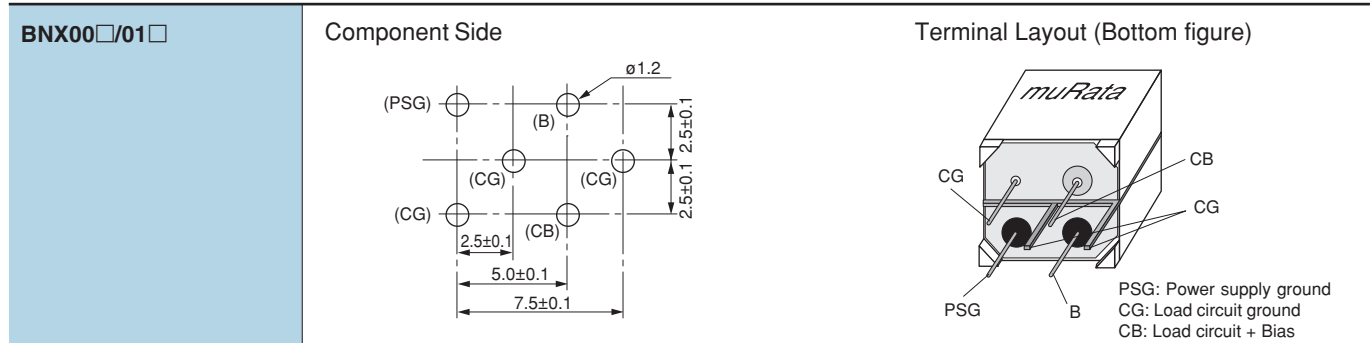

## 2. Using the Block Type EMIFIL® (Lead Type) Effectively

### (1) How to use effectively

This product effectively prevents undesired radiation and external noise from going out / entering the circuit by grounding the high frequency components which cause noise problems. Therefore, grounding conditions may affect the performance of the filter and attention should be paid to the following for effective use.

- (a) Design maximized grounding area in the P.C. board, and grounding pattern for all the grounding terminals of the product to be connected. (Please follow the specified recommendations.)
- (b) Minimize the distance between ground of the P.C. board and the ground plate of the product. (Recommend using the through hole connection between grounding area both of component side and bottom side.)
- (c) Insert the terminals into the holes on P.C. board completely.
- (d) Don't connect PSG terminal with CG terminal directly. (See the item 1. Terminal Layout)

### (2) Self-heating

Though this product has a large rated current, localized selfheating may be caused depending on soldering conditions. To avoid this, attention should be paid to the following:

- (a) Use P.C. board with our recommendation on hole diameter / land pattern dimensions, mentioned in the right hand drawing, especially for 4 terminals which pass current.
- (b) Solder the terminals to the P.C. board with soldercover area at least 90%. Otherwise, excess self-heating at connection between terminals and P.C. board may lead to smoke and / or fire of the product even when operating at rated current.
- (c) After installing this product in your product, please make sure the self-heating is within the rated current recommended.

### P. C. Board Patterns

Use a bilateral P.C. board. Insert the BNX into the P.C.board until the root of the terminal is secured, then solder.

#### (1) Component Side View

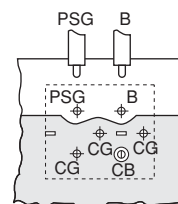

#### (2) Bottom View

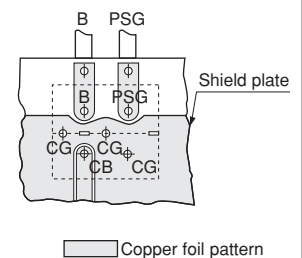

### Recommended Land Pattern

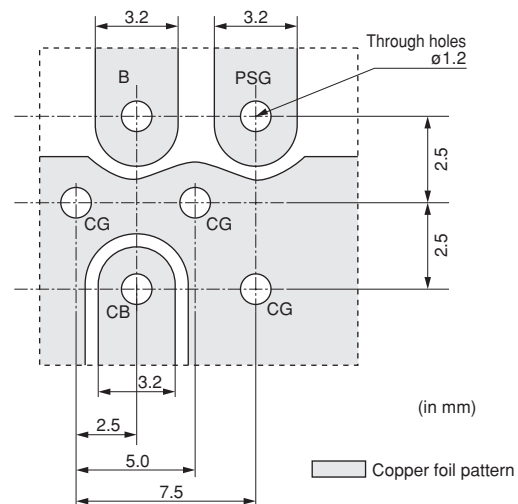

△Note • Please read rating and △CAUTION (for storage, operating, rating, soldering, mounting and handling) in this catalog to prevent smoking and/or burning, etc.  
• This catalog has only typical specifications. Therefore, please approve our product specifications or transact the approval sheet for product specifications before ordering.

**3. Soldering**

- (1) Use Sn-3.0Ag-0.5Cu solder.
- (2) Use Rosin-based flux. Do not use strong acidic flux with halide content exceeding 0.2wt% (chlorine conversion value).
- (3) Products and the leads should not be subjected to any mechanical stress during the soldering process, or while subjected to the equivalent high temperatures.
- (4) Standard flow soldering profile

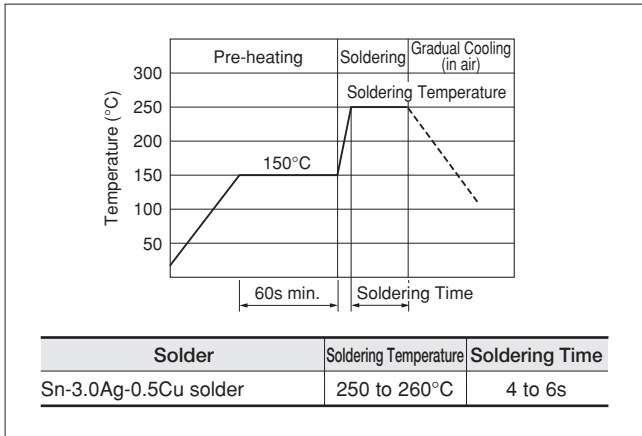

**4. Cleaning**

Clean the block Type EMIFIL®(Lead Type) in the following conditions.

- (1) Cleaning temperature should be limited to 60°C max. (40°C max for alcohol type cleaner).
- (2) Ultrasonic cleaning should comply with the following conditions, avoiding the resonance phenomenon at the mounted products and P.C.B.
  - Power: 20W/liter max.
  - Frequency: 28 to 40kHz
  - Time: 5 min. max.
- (3) Cleaner
  - (a) Alcohol type cleaner  
Isopropyl alcohol (IPA)
  - (b) Aqueous agent  
Pine Alpha ST-100S

- (4) There should be no residual flux or residual cleaner left after cleaning.
  - In the case of using aqueous agent, products should be dried completely after rinsing with de-ionized water in order to remove the cleaner.
- (5) The surface of products may become dirty after cleaning, but there is no deterioration on mechanical, electrical characteristics and reliability.
- (6) Other cleaning: Please contact us.

⚠Note • Please read rating and ⚠CAUTION (for storage, operating, rating, soldering, mounting and handling) in this catalog to prevent smoking and/or burning, etc.  
• This catalog has only typical specifications. Therefore, please approve our product specifications or transact the approval sheet for product specifications before ordering.

Chip Ferrite Bead  
Chip EMIFIL®  
Chip Common Mode Choke Coil  
Soldering and Mounting  
Block Type EMIFIL®  
Microwave Absorber



## Minimum Quantity and Dimensions of 24mm Width Embossed Tape

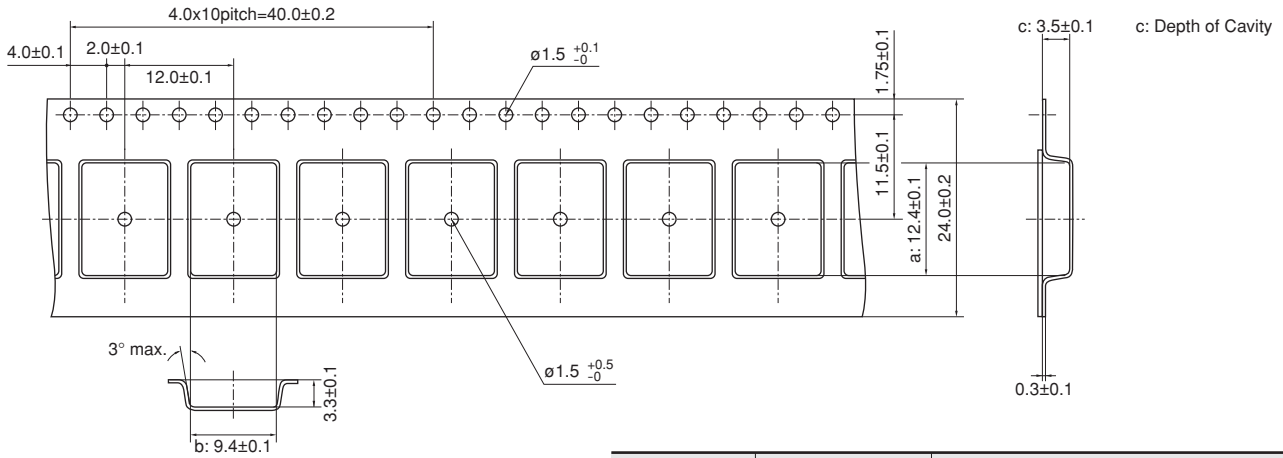

Dimension of the cavity is measured at the bottom side.

| Part Number | Dimensions |     |     | Minimum Qty. (pcs.) |             |      |
|-------------|------------|-----|-----|---------------------|-------------|------|
|             | a          | b   | c   | ø180mm Reel         | ø330mm Reel | Bulk |
| BNX022/023  | 12.4       | 9.4 | 3.5 | 400                 | 1500        | 100  |

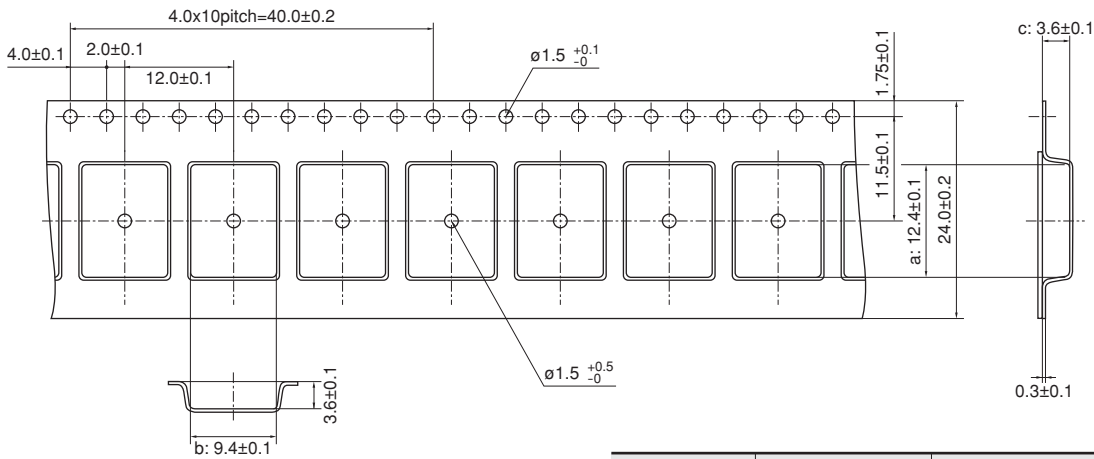

Dimension of the cavity is measured at the bottom side.

| Part Number | Dimensions |     |     | Minimum Qty. (pcs.) |             |      |
|-------------|------------|-----|-----|---------------------|-------------|------|
|             | a          | b   | c   | ø180mm reel         | ø330mm reel | Bulk |
| BNX024/025  | 12.4       | 9.4 | 3.6 | 400                 | 1500        | 100  |

(in mm)

"Minimum Quantity" means the number of units of each delivery or order. The quantity should be an integral multiple of the "Minimum Quantity."

⚠Note • Please read rating and ⚠CAUTION (for storage, operating, rating, soldering, mounting and handling) in this catalog to prevent smoking and/or burning, etc.  
• This catalog has only typical specifications. Therefore, please approve our product specifications or transact the approval sheet for product specifications before ordering.

# BNX Block Type EMIFIL® Design Kits



## ●EKEPBLCKAD-KIT

| No. | Part Number     | Quantity (pcs.) | Common Mode Impedance (at 10MHz, 20 degrees C) | Rated Voltage (Vdc) | Rated Current (A) |
|-----|-----------------|-----------------|--|---------------------|-------------------|
| 1   | PLT10HH450180PN | 2               | 45Ω (Typ.)                                     | 300                 | 18                |
| 2   | PLT10HH101150PN | 2               | 100Ω (Typ.)                                    | 300                 | 15                |
| 3   | PLT10HH401100PN | 2               | 400Ω (Typ.)                                    | 100                 | 10                |
| 4   | PLT10HH501100PN | 2               | 500Ω (Typ.)                                    | 100                 | 10                |
| 5   | PLT10HH9016R0PN | 2               | 900Ω (Typ.)                                    | 100                 | 6                 |
| 6   | PLT10HH1026R0PN | 2               | 1000Ω (Typ.)                                   | 100                 | 6                 |

| No. | Part Number | Quantity (pcs.) | Insertion Loss             | Rated Voltage (Vdc) | Rated Current (A) |
|-----|-------------|-----------------|----------------------------|---------------------|-------------------|
| 7   | BNX002-01   | 1               | 1MHz to 1GHz : 40dB min.   | 50                  | 10                |
| 8   | BNX003-01   | 1               | 5MHz to 1GHz : 40dB min.   | 150                 | 10                |
| 9   | BNX005-01   | 1               | 1MHz to 1GHz : 40dB min.   | 50                  | 15                |
| 10  | BNX012-01   | 1               | 1MHz to 1GHz : 40dB min.   | 50                  | 15                |
| 11  | BNX016-01   | 1               | 100kHz to 1GHz : 40dB min. | 25                  | 15                |
| 12  | BNX022-01   | 2               | 1MHz to 1GHz : 35dB min.   | 50                  | 10                |
| 13  | BNX023-01   | 2               | 1MHz to 1GHz : 35dB min.   | 100                 | 15                |
| 14  | BNX024H01   | 2               | 100kHz to 1GHz : 35dB min. | 50                  | 15                |
| 15  | BNX025H01   | 2               | 50kHz to 1GHz : 35dB min.  | 25                  | 15                |

△Note • Please read rating and △CAUTION (for storage, operating, rating, soldering, mounting and handling) in this catalog to prevent smoking and/or burning, etc.  
 • This catalog has only typical specifications. Therefore, please approve our product specifications or transact the approval sheet for product specifications before ordering.

# EA

## Microwave Absorber

|                      |     |
|----------------------|-----|
| Part Numbering ..... | 234 |
| Product Detail ..... | 235 |
| Notice .....         | 238 |

Chip Ferrite Bead

Chip EMIFIL®

Chip Common Mode Choke Coil

Block Type EMIFIL®

Microwave Absorber

⚠Note • Please read rating and ⚠CAUTION (for storage, operating, rating, soldering, mounting and handling) in this catalog to prevent smoking and/or burning, etc.  
• This catalog has only typical specifications. Therefore, please approve our product specifications or transact the approval sheet for product specifications before ordering.

# EA Microwave Absorber Part Numbering

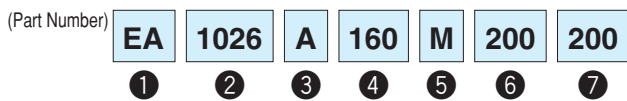

## ① Product ID

| Product ID |                    |
|------------|--------------------|
| <b>EA</b>  | Microwave Absorber |

## ② Sheet Type

| Code        | Sheet Type   |
|-------------|--|
| <b>10□□</b> | Iron carbonyl type (UL certified type/Halogen Free type) |
| <b>2070</b> | Metal Flake Powder (Halogen Free type)                   |
| <b>2100</b> | Metal Flake Powder (UL certified type)                   |
| <b>3008</b> | Magnetic material (UL certified type/Halogen Free type)  |

## ③ Adhesive Tape Type

| Code     | Adhesive Tape Type                          |
|----------|---|
| <b>A</b> | Standard tape type (Halogen Free type)      |
| <b>B</b> | Thin Adhesive tape type (Halogen Free type) |
| <b>L</b> | No tape type                                |
| <b>U</b> | UL certified type (Halogen Free type)       |

## ④ Sheet Thickness

Expressed by 3 digits including the second decimal place in mm.

Ex.)

| Code       | Sheet Thickness |
|------------|-----------------|
| <b>020</b> | 0.20mm          |

## ⑤ Unit of Dimension

One capital letter expresses Unit of Dimension (⑥) and Dimensions Length (⑦).

| Code     | Unit of Dimension |
|----------|-------------------|
| <b>M</b> | in mm (Standard)  |
| <b>C</b> | in cm (Standard)  |

Standard shape is a rectangle.

Please contact us for other shapes.

## ⑥ Dimension (Length)

Expressed by 3 digits including the first decimal place.

## ⑦ Dimension (Width)

Expressed by 3 digits including the first decimal place.

Ex.)

| Code           | Dimension (Length × Width) |
|----------------|----------------------------|
| <b>M300150</b> | 30.0×15.0 mm               |
| <b>C150100</b> | 15.0×10.0 cm               |

△Note • Please read rating and △CAUTION (for storage, operating, rating, soldering, mounting and handling) in this catalog to prevent smoking and/or burning, etc.  
• This catalog has only typical specifications. Therefore, please approve our product specifications or transact the approval sheet for product specifications before ordering.

# EA10 Series

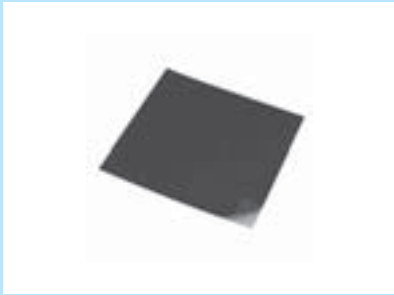

### ■ Packaging

When inquiring, please contact us with size code, referring to "Part Numbering."

### ■ Rated Value

| Part Number | Applicable Frequency (Typ.) | Thickness (Typ.) | Flame Class | Halogen      | Operating Temperature Range |
|-------------|-----------------------------|------------------|-------------|--------------|-----------------------------|
| EA1026A100  | 20.0GHz                     | 1.0mm            | UL94V-0     | Halogen Free | -40°C to +80°C              |
| EA1026A160  | 11.5GHz                     | 1.6mm            | UL94V-0     | Halogen Free | -40°C to +80°C              |
| EA1026A180  | 10.0GHz                     | 1.8mm            | UL94V-0     | Halogen Free | -40°C to +80°C              |
| EA1046A180  | 5.8GHz                      | 1.8mm            | UL94V-0     | Halogen Free | -40°C to +80°C              |
| EA1075A270  | 2.5GHz                      | 2.7mm            | UL94V-0     | Halogen Free | -40°C to +80°C              |

### ■ Reflection Loss (Typ.)

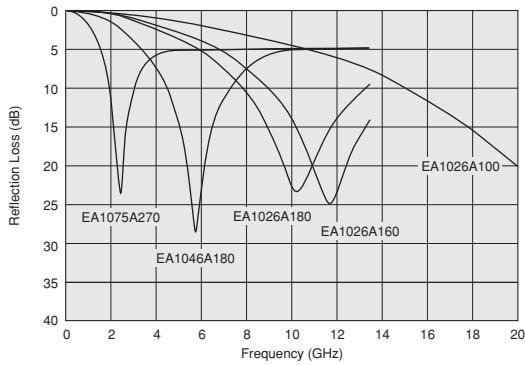

⚠Note • Please read rating and ⚠CAUTION (for storage, operating, rating, soldering, mounting and handling) in this catalog to prevent smoking and/or burning, etc.  
 • This catalog has only typical specifications. Therefore, please approve our product specifications or transact the approval sheet for product specifications before ordering.

# EA20/EA21 Series



### ■ Packaging

When inquiring, please contact us with size code, referring to "Part Numbering."

### ■ Rated Value

| Part Number | Applicable Frequency (Typ.) | Thickness (Typ.) | Flame Class | Halogen      | Operating Temperature Range |
|-------------|-----------------------------|------------------|-------------|--------------|-----------------------------|
| EA2070A020  | 0.1 to 3.0GHz               | 0.20mm           | -           | Halogen Free | -40°C to +120°C             |
| EA2070A050  | 0.1 to 3.0GHz               | 0.50mm           | -           | Halogen Free | -40°C to +120°C             |
| EA2070A100  | 0.1 to 3.0GHz               | 1.00mm           | -           | Halogen Free | -40°C to +120°C             |
| EA2070B005  | 0.1 to 3.0GHz               | 0.05mm           | -           | Halogen Free | -40°C to +120°C             |
| EA2070B010  | 0.1 to 3.0GHz               | 0.10mm           | -           | Halogen Free | -40°C to +120°C             |
| EA2070B013  | 0.1 to 3.0GHz               | 0.13mm           | -           | Halogen Free | -40°C to +120°C             |
| EA2070B020  | 0.1 to 3.0GHz               | 0.20mm           | -           | Halogen Free | -40°C to +120°C             |
| EA2070B050  | 0.1 to 3.0GHz               | 0.50mm           | -           | Halogen Free | -40°C to +120°C             |
| EA2100A020  | 0.1 to 3.0GHz               | 0.20mm           | UL94V-0     | -            | -40°C to +120°C             |
| EA2100A050  | 0.1 to 3.0GHz               | 0.50mm           | UL94V-0     | -            | -40°C to +120°C             |
| EA2100A100  | 0.1 to 3.0GHz               | 1.00mm           | UL94V-0     | -            | -40°C to +120°C             |
| EA2100B020  | 0.1 to 3.0GHz               | 0.20mm           | UL94V-0     | -            | -40°C to +120°C             |
| EA2100B050  | 0.1 to 3.0GHz               | 0.50mm           | UL94V-0     | -            | -40°C to +120°C             |
| EA2100B100  | 0.1 to 3.0GHz               | 1.00mm           | UL94V-0     | -            | -40°C to +120°C             |

### ■ Magnetic Permeability-Reluctance

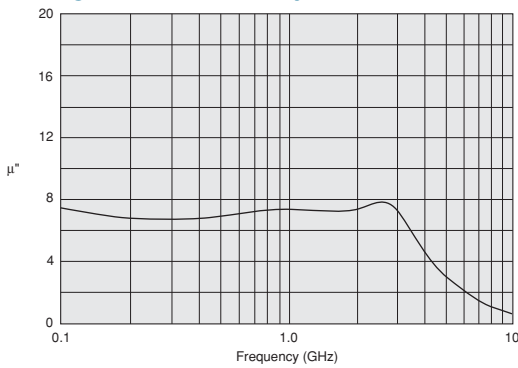

⚠Note • Please read rating and ⚠CAUTION (for storage, operating, rating, soldering, mounting and handling) in this catalog to prevent smoking and/or burning, etc.  
 • This catalog has only typical specifications. Therefore, please approve our product specifications or transact the approval sheet for product specifications before ordering.

Chip Ferrite Bead  
Chip EMIFIL®  
Chip Common Mode Choke Coil  
Block Type EMIFIL®  
Microwave Absorber

# EA30 Series



### ■ Packaging

When inquiring, please contact us with size code, referring to "Part Numbering."

### ■ Rated Value

| Part Number | Applicable Frequency (Typ.) | Thickness (Typ.) | Flame Class | Halogen      | Operating Temperature Range |
|-------------|-----------------------------|------------------|-------------|--------------|-----------------------------|
| EA3008U025  | 0.1 to 3.0GHz               | 0.25mm           | UL94V-0     | Halogen Free | -40°C to +120°C             |
| EA3008U035  | 0.1 to 3.0GHz               | 0.35mm           | UL94V-0     | Halogen Free | -40°C to +120°C             |
| EA3008U050  | 0.1 to 3.0GHz               | 0.50mm           | UL94V-0     | Halogen Free | -40°C to +120°C             |
| EA3008U100  | 0.1 to 3.0GHz               | 1.00mm           | UL94V-0     | Halogen Free | -40°C to +120°C             |
| EA3008U250  | 0.1 to 3.0GHz               | 2.50mm           | UL94V-0     | Halogen Free | -40°C to +120°C             |

### ■ Magnetic Permeability-Reluctance

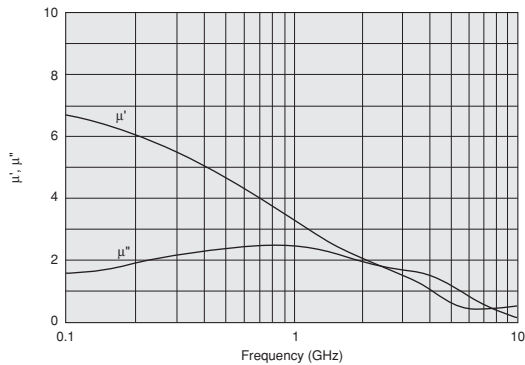

⚠Note • Please read rating and ⚠CAUTION (for storage, operating, rating, soldering, mounting and handling) in this catalog to prevent smoking and/or burning, etc.  
 • This catalog has only typical specifications. Therefore, please approve our product specifications or transact the approval sheet for product specifications before ordering.

## Notice

## ● Storage and Operating Conditions

## 1. Adhesive Tape Stress

This product is designed to use adhesive tape to hold itself to the object.

And please avoid causing mechanical stress by bending or variation of the object.

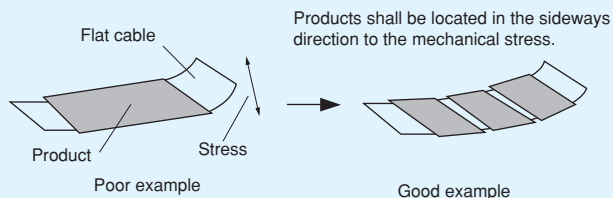

## 2. Cleaning

Avoid cleaning this product.

## 3. Handling of the Product

Adhesive tape must be clean to maintain the quality of adhesion.

Please wipe off any dirt, dust and any kind of oil from the surface of the object before use.

## 4. Storage Conditions

## (1) Storage period

Products that were inspected by Murata over 6 months ago should be examined and used. This can be confirmed by the inspection No. marked on the container.

Adhesiveness should be checked if this period is exceeded.

## (2) Storage conditions

· Products should be stored in the warehouse in the following conditions:

Temperature: -10 to +40°C

Humidity: 30 to 70% relative humidity

No rapid change of temperature or humidity

· Products should be stored in the warehouse without heat shock condition, vibration, direct sunlight and so on.



# Product Guide by Size

| Which Size?<br>inch (mm) | Inductor Type  | Capacitor Type  |   |                                    | Common Mode Choke Coils  | Block Type<br>L×W×T(mm)   |
|--------------------------|--|---|---|------------------------------------|--|---|
|                          |  | Simple Capacitor  | LC(RC) Combined   | T Circuit Filter Feed Through Type |  |   |
| 01005 (0402)             | BLM02AX <small>p24</small><br>BLM02BX <small>p26</small>   |   |   |                                    |  | 12×11×max13<br><small>p223</small><br>BNX002-01<br>BNX003-01<br>Lead    |
| 0201 (0603)              | BLM03AG <small>p32</small> BLM03AX <small>p30</small><br>BLM03B <small>p34</small> BLM03E <small>p87</small><br>BLM03P <small>p27</small> BLM03H <small>p85</small>  |   |   |                                    |  |   |
| 025020 (0605)            |  |   |   |                                    | DLP0QS <small>p186</small>   |   |
| 03025 (0806)             |  |   |   |                                    | DLP0NS <small>p187</small>   |   |
| 0402 (1005)              | BLM15AG <small>p42</small> BLM15AX <small>p40</small><br>BLM15B <small>p44</small> BLM15HD <small>p88</small><br>BLM15P <small>p36</small> BLM15HB <small>p88</small><br>BLM15E <small>p90</small> BLM15GG <small>p91</small><br>BLM15HG <small>p88</small> BLM15GA <small>p91</small>   | NFM15CC <small>p134</small><br>NFM15PC <small>p123</small>                                | NFL15ST <small>p140</small>   |                                    |  | 12×11×max13.5<br><small>p223</small><br>BNX005-01<br>Lead               |
| 05025 (1506)             |  |   |   |                                    | DLP1ND <small>p193</small>   |   |
| 0504 (1210)              |  |   |   |                                    | DLM11G <small>p184</small><br>DLM11S <small>p185</small><br>DLP11S/11R/11T <small>p189</small><br><small>p190</small><br><small>p191</small> |   |
| 0603 (1608)              | BLM18A <small>p56</small> BLM18E <small>p96</small><br>BLM18T <small>p62</small> BLM18HE <small>p92</small><br>BLM18B <small>p58</small> BLM18HG <small>p92</small><br>BLM18R <small>p63</small> BLM18HD <small>p92</small><br>BLM18P <small>p50</small> BLM18HB <small>p92</small><br>BLM18K <small>p52</small> BLM18HK <small>p92</small><br>BLM18S <small>p54</small> BLM18G <small>p98</small> | NFM18CC <small>p135</small><br>NFM18PS <small>p125</small><br>NFM18PC <small>p126</small> | NFL18ST <small>p141</small><br>NFL18SP <small>p143</small>                        |                                    |  | 12×11×max8.5<br><small>p224</small><br>BNX012-01<br>BNX016-01<br>Lead   |
| Array                    |  |   | NFA18SL <small>p145</small><br>NFA18SD <small>p146</small><br><small>p147</small> |                                    |  |   |
| 0804 (2010)<br>Array     | BLA2AA <small>p80</small><br>BLA2AB <small>p80</small>   |   |   |                                    | DLP2AD <small>p194</small>   |   |
| 0805 (2012)              | BLM21A <small>p68</small> BLM21R <small>p73</small><br>BLM21B <small>p70</small> BLM21P <small>p66</small>   | NFM21CC <small>p136</small><br>NFM21PS <small>p128</small><br>NFM21PC <small>p129</small> | NFL21SP <small>p144</small><br>NFR21GD <small>p152</small>                        |                                    | DLW21S <small>p197</small><br>DLW21H <small>p199</small>   |   |
| Array                    |  |   | NFA21SL <small>p148</small><br><small>p149</small>                                |                                    |  |   |
| 1205 (3212)              |  | NFM3DCC <small>p137</small><br>NFM3DPC <small>p130</small>                                |   |                                    |  | 9.1×12.1×max3.3<br><small>p221</small><br>BNX022-01<br>BNX023-01<br>SMD |
| 1206 (3216)              | BLM31P <small>p75</small>  | NFM31PC <small>p131</small><br>NFM31KC <small>p132</small>                                | NFW31SP <small>p150</small>   | NFE31PT <small>p121</small>        | DLP31S <small>p192</small><br>DLW31S <small>p200</small><br>DLP31D <small>p196</small>   |   |
| Array                    | BLA31A <small>p83</small><br>BLA31B <small>p83</small>   |   | NFA31CC <small>p139</small><br>NFA31GD <small>p153</small>                        |                                    |  |   |
| 1210 (3225)              | BLE32P <small>p79</small>  |   |   |                                    |  |   |
| 1806 (4516)              | BLM41P <small>p77</small>  | NFM41CC <small>p138</small><br>NFM41PC <small>p133</small>                                |   |                                    |  |   |
| 1812 (4532)              |  |   |   |                                    | DLW43S <small>p201</small>   | 9.1×12.1×max3.7<br><small>p221</small><br>BNX024H01<br>BNX025H01<br>SMD |
| 2014 (5036)              |  |   |   |                                    | DLW5AH <small>p177</small><br>DLW5AT <small>p179</small><br><small>p181</small>  |   |
| 2020 (5050)              |  |   |   |                                    | DLW5BS <small>p177</small><br>DLW5BT <small>p179</small><br><small>p181</small>  |   |
| 2606 (6816)              |  |   |   | NFE61PT <small>p122</small>        |  |   |

△Note • Please read rating and △CAUTION (for storage, operating, rating, soldering, mounting and handling) in this catalog to prevent smoking and/or burning, etc.  
• This catalog has only typical specifications. Therefore, please approve our product specifications or transact the approval sheet for product specifications before ordering.

## Part Number Quick Reference

### BL□ Series

|            |     |
|------------|-----|
| BLA2AA     | p80 |
| BLA2AB     | p80 |
| BLA31A     | p83 |
| BLA31B     | p83 |
| BLE32P     | p79 |
| BLM02AX    | p24 |
| BLM02BX    | p26 |
| BLM03AG    | p32 |
| BLM03AX    | p30 |
| BLM03B     | p34 |
| BLM03E     | p87 |
| BLM03H     | p85 |
| BLM03PG    | p27 |
| BLM03PX    | p28 |
| BLM15AG    | p42 |
| BLM15AX    | p40 |
| BLM15B     | p46 |
| BLM15BX    | p44 |
| BLM15E     | p90 |
| BLM15GA    | p91 |
| BLM15GG    | p91 |
| BLM15HB    | p88 |
| BLM15HD    | p88 |
| BLM15HG    | p88 |
| BLM15PG/PD | p38 |
| BLM15PX    | p36 |
| BLM18A     | p56 |
| BLM18B     | p58 |
| BLM18EG    | p96 |
| BLM18G     | p98 |
| BLM18HB    | p92 |
| BLM18HD    | p92 |
| BLM18HE    | p92 |
| BLM18HG    | p92 |
| BLM18HK    | p92 |
| BLM18K     | p52 |
| BLM18P     | p50 |
| BLM18R     | p63 |
| BLM18S     | p54 |
| BLM18T     | p62 |
| BLM21A     | p68 |
| BLM21B     | p70 |
| BLM21P     | p66 |
| BLM21R     | p73 |
| BLM31P     | p75 |
| BLM41P     | p77 |

### NF□ Series

|         |      |
|---------|------|
| NFA18SD | p147 |
| NFA18SL | p145 |
| NFA21SL | p148 |
| NFA31CC | p139 |
| NFA31GD | p153 |
| NFE31PT | p121 |
| NFE61PT | p122 |
| NFL15ST | p140 |
| NFL18SP | p143 |
| NFL18ST | p141 |
| NFL21SP | p144 |
| NFM15CC | p134 |
| NFM15PC | p123 |
| NFM18CC | p135 |
| NFM18PC | p126 |
| NFM18PS | p125 |
| NFM21CC | p136 |
| NFM21PC | p129 |
| NFM21PS | p128 |
| NFM31KC | p132 |
| NFM31PC | p131 |
| NFM3DCC | p137 |
| NFM3DPC | p130 |
| NFM41CC | p138 |
| NFM41PC | p133 |
| NFR21GD | p152 |
| NFW31SP | p150 |

### DL□ (PL□) Series

|                |      |
|----------------|------|
| DLM11G         | p184 |
| DLM11S         | p185 |
| DLP0NS         | p187 |
| DLP0QS         | p186 |
| DLP11S/11R/11T | p189 |
| DLP1ND         | p193 |
| DLP2AD         | p194 |
| DLP31D         | p196 |
| DLP31S         | p192 |
| DLW21H         | p199 |
| DLW21S         | p197 |
| DLW31S         | p200 |
| DLW43S         | p201 |
| DLW5AH         | p177 |
| DLW5AT         | p179 |
| DLW5BS         | p177 |
| DLW5BT         | p179 |
| PLT10H         | p202 |

### BNX Series

|        |      |
|--------|------|
| BNX002 | p223 |
| BNX003 | p223 |
| BNX005 | p223 |
| BNX012 | p224 |
| BNX016 | p224 |
| BNX022 | p221 |
| BNX023 | p221 |
| BNX024 | p221 |
| BNX025 | p221 |

### EA Series

|      |      |
|------|------|
| EA10 | p235 |
| EA20 | p236 |
| EA21 | p236 |
| EA30 | p237 |

## Alphabetic Product Name Index

|   |                         |   |                 |
|---|-------------------------|---|-----------------|
| 3 Terminal Filter   | p111                    | Chip EMIFIL® LC Combined Type Array       | p145            |
| Block Type EMIFIL® LC Combined Type                           | p221                    | Chip EMIFIL® LC Combined Wire Wound Type  | p150            |
| Chip Common Mode Choke Coil Film Type                         | p186                    | Chip EMIFIL® RC Combined Type             | p152.153        |
| Chip Common Mode Choke Coil Film Type Array                   | p193                    | Chip EMIFIL® RC Combined Type Array       | p153            |
| Chip Common Mode Choke Coil Multilayer Type                   | p184                    | Chip Ferrite Bead                         | p13             |
| Chip Common Mode Choke Coil Wire Wound Type                   | p197                    | Chip Ferrite Bead Array                   | p80             |
| Chip Common Mode Choke Coil Wire Wound Type For Large Current | p177                    | Chip Ferrite Bead For GHz Band Noise      | p85             |
| Chip EMIFIL® Array  | p80.83.139.145.148.153  | Chip Ferrite Bead For High-GHz Band Noise | p91             |
| Chip EMIFIL® Capacitor Type                                   | p111                    | Common Mode Filter                        | p169            |
| Chip EMIFIL® Capacitor Type Array                             | p139                    | EMIFIL®                                   | p13.111.169.217 |
| Chip EMIFIL® Feed Through Type                                | p121                    | EMI Suppression Filter                    | p13.111.169.217 |
| Chip EMIFIL® For Large Current                                | p27.121.123.125.177.221 | LC Combined L Circuit Array               | p145            |
| Chip EMIFIL® Inductor Type                                    | p13                     | L Circuit Filter                          | p145            |
| Chip EMIFIL® LC Combined Multilayer Type                      | p140                    | Microwave Absorber                        | p233            |
| Chip EMIFIL® LC Combined T Circuit Type                       | p121.140                | PI Circuit Filter                         | p143.144.150    |
| Chip EMIFIL® LC Combined Type                                 | p121                    | T Circuit Filter                          | p121.140        |

⚠Note • Please read rating and ⚠CAUTION (for storage, operating, rating, soldering, mounting and handling) in this catalog to prevent smoking and/or burning, etc.  
• This catalog has only typical specifications. Therefore, please approve our product specifications or transact the approval sheet for product specifications before ordering.

Please refer to catalogs below for ferrite cores, Microwave Absorber and leaded EMIFIL<sup>®</sup>.

## Ferrite Core, Microwave Absorber

### Ferrite Core for EMI Suppression Microwave Absorber

**Contents** Thin Type Sandwich Core <FSSA>  
Core for Flat Cables <FSRC>  
Beads Core <FSRH>  
Ring Core <FSRB>  
Microwave Absorber <EA>

This Catalog is PDF version only. Please refer to following URL.  
<http://www.murata.com/products/catalog/pdf/o63e.pdf>



## Lead Type EMIFIL<sup>®</sup>

### EMI Suppression Filters (Lead Type EMIFIL<sup>®</sup>)

**Contents** Ferrite Beads Inductors <BL01/02/03>  
Disc Type EMIFIL<sup>®</sup> <DS□6/DS□9>  
EMIGUARD<sup>®</sup> (EMIFIL<sup>®</sup> with Varistor Function)  
<VF□3/VF□6/VF□9>  
Common Mode Choke Coils <PLT>



△Note • Please read rating and △CAUTION (for storage, operating, rating, soldering, mounting and handling) in this catalog to prevent smoking and/or burning, etc.  
• This catalog has only typical specifications. Therefore, please approve our product specifications or transact the approval sheet for product specifications before ordering.

# EMICON-FUN!

Please check Murata's newsletter!  
 You can learn about electric parts with fun.  
[http://www.murata.com/products/emicon\\_fun/](http://www.murata.com/products/emicon_fun/)

EMICON-FUN! disseminated widely from basics (principles, characteristics, mounting, etc.) of capacitors, EMI suppression filters and inductors to information can practically be used.  
 Updated information is also distributed via the mail magazine.

Click here to register as reader → [http://go.murata.co.jp/Email\\_Newsletter\\_EN.html](http://go.murata.co.jp/Email_Newsletter_EN.html)

You can register from Murata Manufacturing Web site page TOP.  
<http://www.murata.com/products/>



← This banner is the entrance of register form

#####  
 email Magazine: Have fun while learning about electronic components  
 EMICON-FUN!  
 The index of June 14 issue

- Inductor Room
- Product News
- Proposal of the Loss Reduction in the RF Circuit
- Industry Pickup - Smart Phones

Expertly written articles explain the basics of capacitors, inductors and EMI suppression filters.

#####

Product News

- Large Current Common Mode Coil for Automotive Available <PLT10H series>
- 1. Meets large current up to 18A max. suitable for power lines.
- 2. Suitable for surface mounting.
- 3. Large common mode impedance up to 1000ohm [at 10mhz] enables good noise suppression effect.
- 4. Wide operating temperature range from -55°C to 125°C.

[PLT10HH9016R0 / 401100 / 101150 / 450180]  
<http://newsletter.murata.co.jp/c/p?12cel.nY3hk>

△Note • Please read rating and △CAUTION (for storage, operating, rating, soldering, mounting and handling) in this catalog to prevent smoking and/or burning, etc.  
 • This catalog has only typical specifications. Therefore, please approve our product specifications or transact the approval sheet for product specifications before ordering.

# Global Locations

For details please visit [www.murata.com](http://www.murata.com)



## ⚠ Note

### 1 Export Control

*For customers outside Japan:*

No Murata products should be used or sold, through any channels, for use in the design, development, production, utilization, maintenance or operation of, or otherwise contribution to (1) any weapons (Weapons of Mass Destruction [nuclear, chemical or biological weapons or missiles] or conventional weapons) or (2) goods or systems specially designed or intended for military end-use or utilization by military end-users.

*For customers in Japan:*

For products which are controlled items subject to the "Foreign Exchange and Foreign Trade Law" of Japan, the export license specified by the law is required for export.

2 Please contact our sales representatives or product engineers before using the products in this catalog for the applications listed below, which require especially high reliability for the prevention of defects which might directly damage a third party's life, body or property, or when one of our products is intended for use in applications other than those specified in this catalog.

- ① Aircraft equipment
- ② Aerospace equipment
- ③ Undersea equipment
- ④ Power plant equipment
- ⑤ Medical equipment
- ⑥ Transportation equipment (vehicles, trains, ships, etc.)
- ⑦ Traffic signal equipment
- ⑧ Disaster prevention / crime prevention equipment
- ⑨ Data-processing equipment
- ⑩ Application of similar complexity and/or reliability requirements to the applications listed above

3 Product specifications in this catalog are as of March 2014. They are subject to change or our products in it may be discontinued without advance notice. Please check with our sales representatives or product engineers before ordering. If there are any questions, please contact our sales representatives or product engineers.

4 Please read rating and ⚠CAUTION (for storage, operating, rating, soldering, mounting and handling) in this catalog to prevent smoking and/or burning, etc.

5 This catalog has only typical specifications. Therefore, please approve our product specifications or transact the approval sheet for product specifications before ordering.

6 Please note that unless otherwise specified, we shall assume no responsibility whatsoever for any conflict or dispute that may occur in connection with the effect of our and/or a third party's intellectual property rights and other related rights in consideration of your use of our products and/or information described or contained in our catalogs. In this connection, no representation shall be made to the effect that any third parties are authorized to use the rights mentioned above under licenses without our consent.

7 No ozone depleting substances (ODS) under the Montreal Protocol are used in our manufacturing process.

Murata Manufacturing Co., Ltd.

[www.murata.com](http://www.murata.com)

**muRata**  
INNOVATOR IN ELECTRONICS