

## N-Channel Power MOSFET

60V, 51A, 13mΩ

### FEATURES

- Low  $R_{DS(ON)}$  to minimize conductive losses
- Logic level
- Low gate charge for fast power switching
- 100% UIS and  $R_g$  tested.
- 175°C Operating Junction Temperature
- Compliant to RoHS directive 2011/65/EU and in accordance to WEEE 2002/96/EC
- Halogen-free according to IEC 61249-2-21

### APPLICATIONS

- BLDC Motor Control
- Battery Power Management
- DC-DC converter
- Secondary Synchronous Rectification

KEY PERFORMANCE PARAMETERS		
PARAMETER	VALUE	UNIT
$V_{DS}$	60	V
$R_{DS(on)}$ (max)	$V_{GS} = 10V$	13
	$V_{GS} = 4.5V$	18
$Q_g$	18	nC

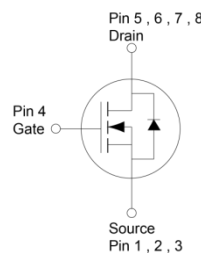
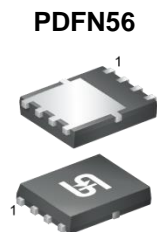

Note: MSL 1 (Moisture Sensitivity Level) per J-STD-020

ABSOLUTE MAXIMUM RATINGS ( $T_A = 25^\circ\text{C}$ unless otherwise noted)			
PARAMETER	SYMBOL	LIMIT	UNIT
Drain-Source Voltage	$V_{DS}$	60	V
Gate-Source Voltage	$V_{GS}$	$\pm 20$	V
Continuous Drain Current (Note 1)	$I_D$	$T_C = 25^\circ\text{C}$	51
		$T_A = 25^\circ\text{C}$	10
Pulsed Drain Current	$I_{DM}$	204	A
Single Pulse Avalanche Current (Note 2)	$I_{AS}$	20	A
Single Pulse Avalanche Energy (Note 2)	$E_{AS}$	60	mJ
Total Power Dissipation	$P_D$	$T_C = 25^\circ\text{C}$	83
		$T_C = 125^\circ\text{C}$	28
Total Power Dissipation	$P_D$	$T_A = 25^\circ\text{C}$	3.1
		$T_A = 125^\circ\text{C}$	1
Operating Junction and Storage Temperature Range	$T_J, T_{STG}$	- 55 to +175	$^\circ\text{C}$

THERMAL PERFORMANCE			
PARAMETER	SYMBOL	LIMIT	UNIT
Junction to Case Thermal Resistance	$R_{\theta JC}$	1.8	$^\circ\text{C/W}$
Junction to Ambient Thermal Resistance	$R_{\theta JA}$	48	$^\circ\text{C/W}$

**Thermal Performance Note:**  $R_{\theta JA}$  is the sum of the junction-to-case and case-to-ambient thermal resistances. The case-thermal reference is defined at the solder mounting surface of the drain pins.  $R_{\theta JA}$  is guaranteed by design while  $R_{\theta CA}$  is determined by the user's board design. The  $R_{\theta JA}$  limit presented here is based on mounting on a 1 in<sup>2</sup> pad of 2 oz copper.

<b>ELECTRICAL SPECIFICATIONS</b> ( $T_A = 25^\circ\text{C}$ unless otherwise noted)						
PARAMETER	CONDITIONS	SYMBOL	MIN	TYP	MAX	UNIT
<b>Static</b>						
Drain-Source Breakdown Voltage	$V_{GS} = 0\text{V}, I_D = 250\mu\text{A}$	$BV_{DSS}$	60	--	--	V
Gate Threshold Voltage	$V_{GS} = V_{DS}, I_D = 250\mu\text{A}$	$V_{GS(TH)}$	1	1.7	2.5	V
Gate-Source Leakage Current	$V_{GS} = \pm 20\text{V}, V_{DS} = 0\text{V}$	$I_{GSS}$	--	--	$\pm 100$	nA
Drain-Source Leakage Current	$V_{GS} = 0\text{V}, V_{DS} = 60\text{V}$	$I_{DSS}$	--	--	1	$\mu\text{A}$
	$V_{GS} = 0\text{V}, V_{DS} = 60\text{V}$ $T_J = 125^\circ\text{C}$		--	--	100	
Drain-Source On-State Resistance (Note 3)	$V_{GS} = 10\text{V}, I_D = 10\text{A}$	$R_{DS(on)}$	--	12	13	m $\Omega$
	$V_{GS} = 4.5\text{V}, I_D = 8\text{A}$		--	14	18	
Forward Transconductance (Note 3)	$V_{DS} = 10\text{V}, I_D = 10\text{A}$	$g_{fs}$	--	39	--	S
<b>Dynamic</b> (Note 4)						
Total Gate Charge	$V_{GS} = 10\text{V}, V_{DS} = 30\text{V},$ $I_D = 10\text{A}$	$Q_g$	--	37	--	nC
Total Gate Charge	$V_{GS} = 4.5\text{V}, V_{DS} = 30\text{V},$ $I_D = 8\text{A}$	$Q_g$	--	18	--	
Gate-Source Charge		$Q_{gs}$	--	7	--	
Gate-Drain Charge		$Q_{gd}$	--	9	--	
Input Capacitance	$V_{GS} = 0\text{V}, V_{DS} = 30\text{V}$ $f = 1.0\text{MHz}$	$C_{iss}$	--	2175	--	pF
Output Capacitance		$C_{oss}$	--	142	--	
Reverse Transfer Capacitance		$C_{rss}$	--	63	--	
Gate Resistance	$f = 1.0\text{MHz}$	$R_g$	0.5	1.5	3	$\Omega$
<b>Switching</b> (Note 4)						
Turn-On Delay Time	$V_{GS} = 10\text{V}, V_{DS} = 30\text{V},$ $I_D = 10\text{A}, R_G = 2\Omega$	$t_{d(on)}$	--	2	--	ns
Turn-On Rise Time		$t_r$	--	19	--	
Turn-Off Delay Time		$t_{d(off)}$	--	23	--	
Turn-Off Fall Time		$t_f$	--	19	--	
<b>Source-Drain Diode</b>						
Forward Voltage (Note 3)	$V_{GS} = 0\text{V}, I_S = 10\text{A}$	$V_{SD}$	--	--	1	V
Reverse Recovery Time	$I_S = 10\text{A},$ $di/dt = 100\text{A}/\mu\text{s}$	$t_{rr}$	--	15	--	ns
Reverse Recovery Charge		$Q_{rr}$	--	9	--	nC

**Notes:**

- Silicon limited current only.
- $L = 0.3\text{mH}, V_{GS} = 10\text{V}, V_{DD} = 30\text{V}, R_G = 25\Omega, I_{AS} = 20\text{A}$ , Starting  $T_J = 25^\circ\text{C}$
- Pulse test: Pulse Width  $\leq 300\mu\text{s}$ , duty cycle  $\leq 2\%$ .
- Switching time is essentially independent of operating temperature.

**ORDERING INFORMATION**

PART NO.	PACKAGE	PACKING
TSM130NB06LCR RLG	PDFN56	2,500pcs / 13" Reel

**CHARACTERISTICS CURVES**

( $T_A = 25^\circ\text{C}$  unless otherwise noted)

**Output Characteristics**

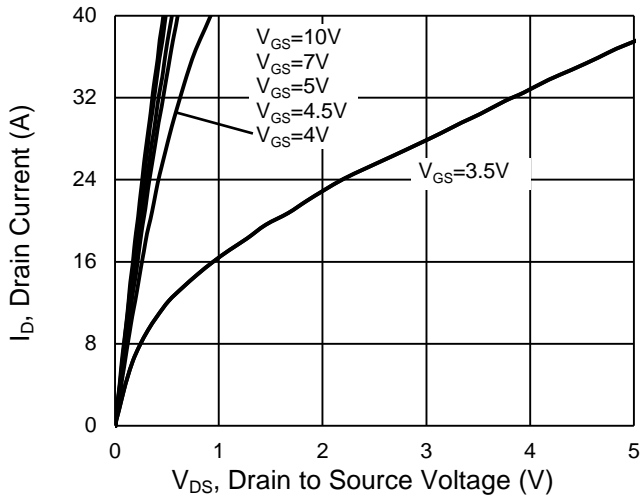

**Transfer Characteristics**

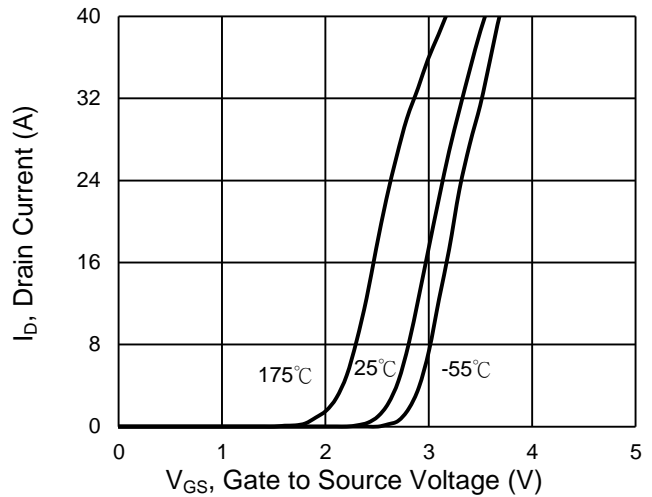

**On-Resistance vs. Drain Current**

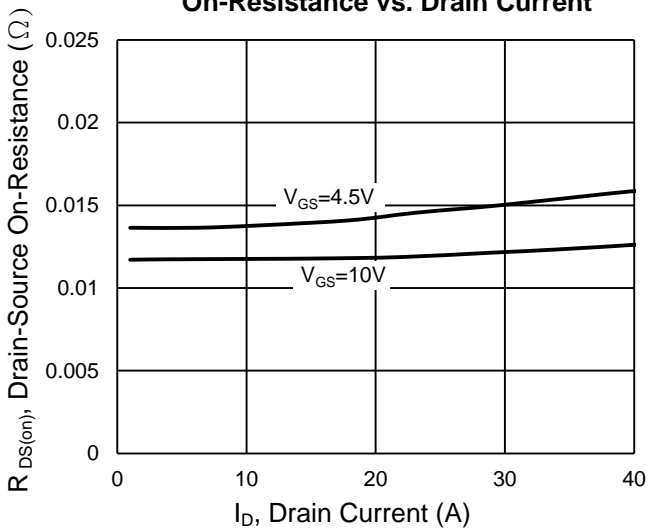

**Gate-Source Voltage vs. Gate Charge**

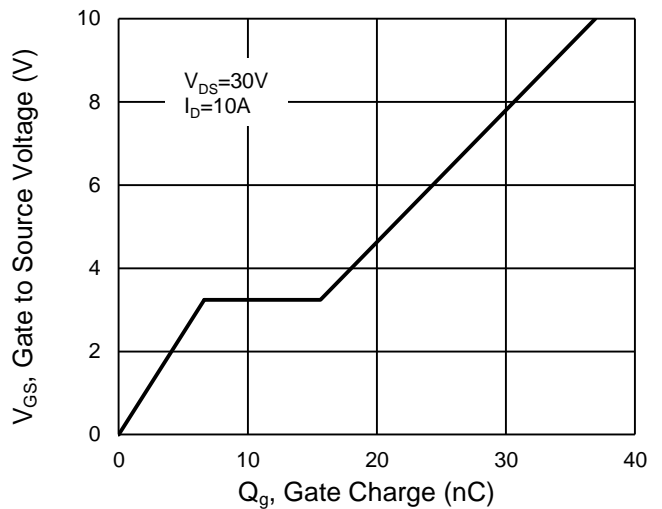

**On-Resistance vs. Junction Temperature**

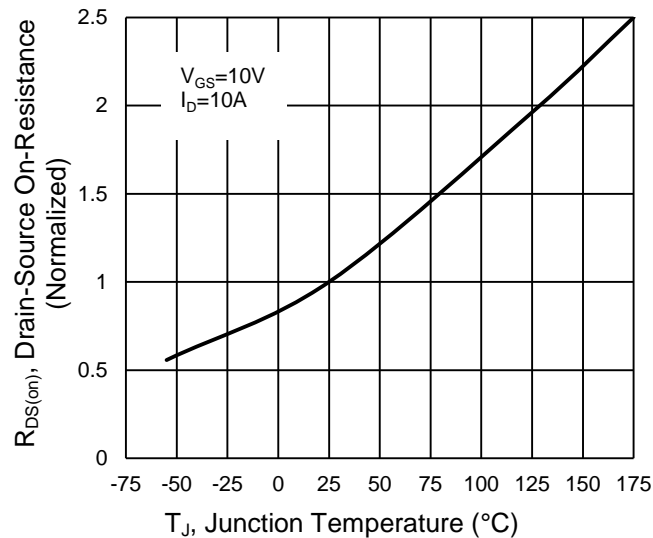

**On-Resistance vs. Gate-Source Voltage**

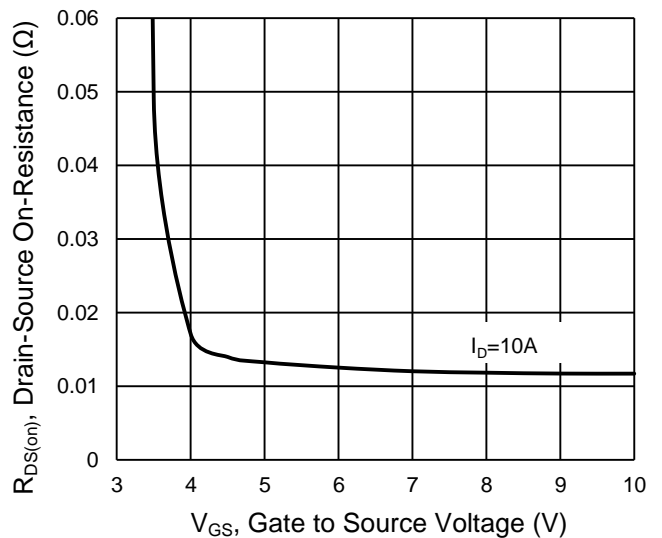

**CHARACTERISTICS CURVES**

( $T_A = 25^\circ\text{C}$  unless otherwise noted)

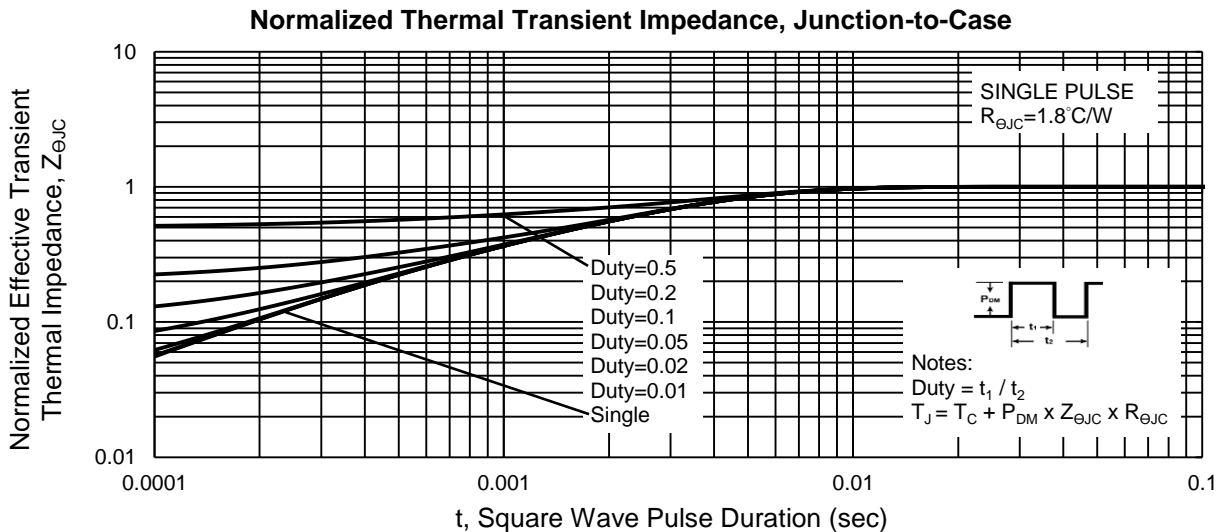
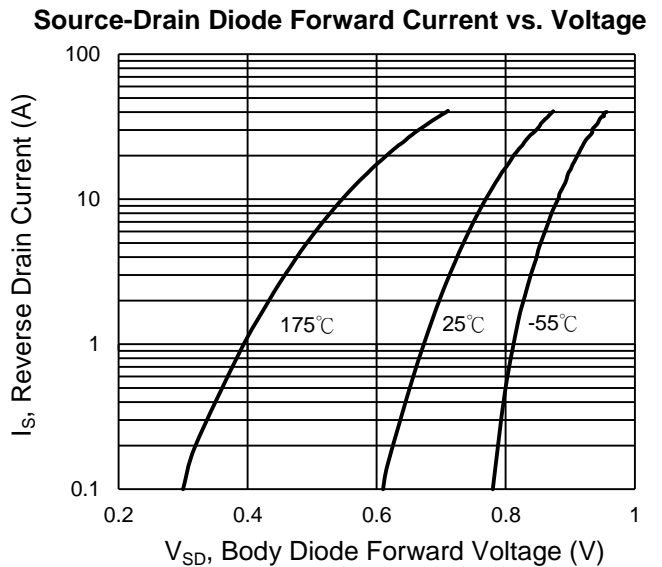
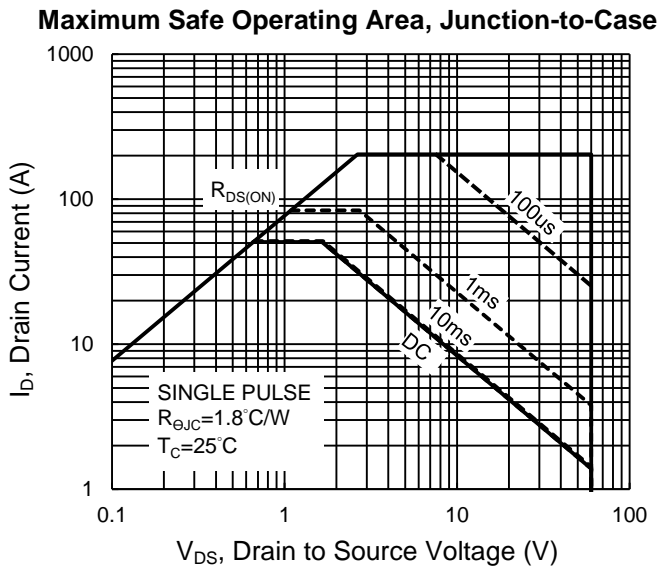
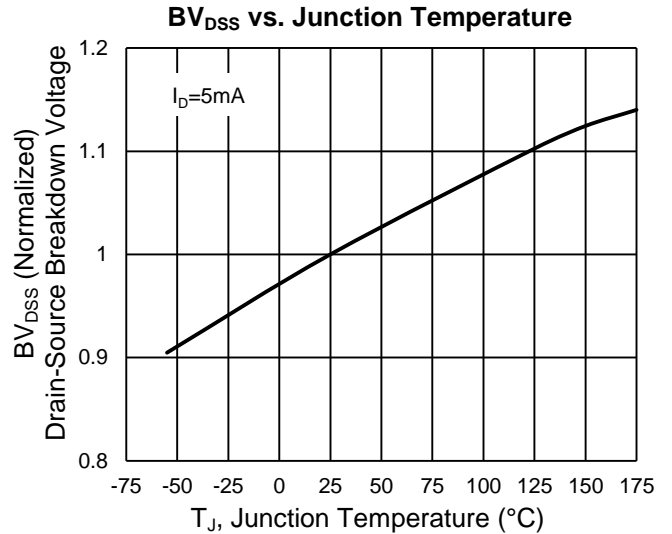
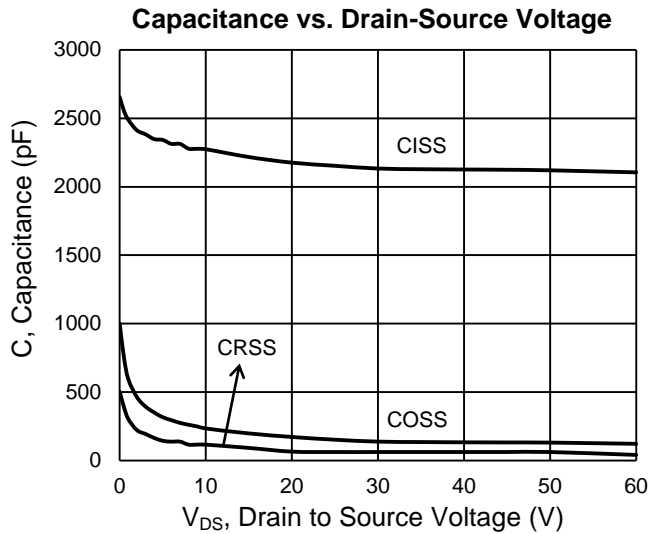

**PACKAGE OUTLINE DIMENSIONS** (Unit: Millimeters)

**PDFN56**

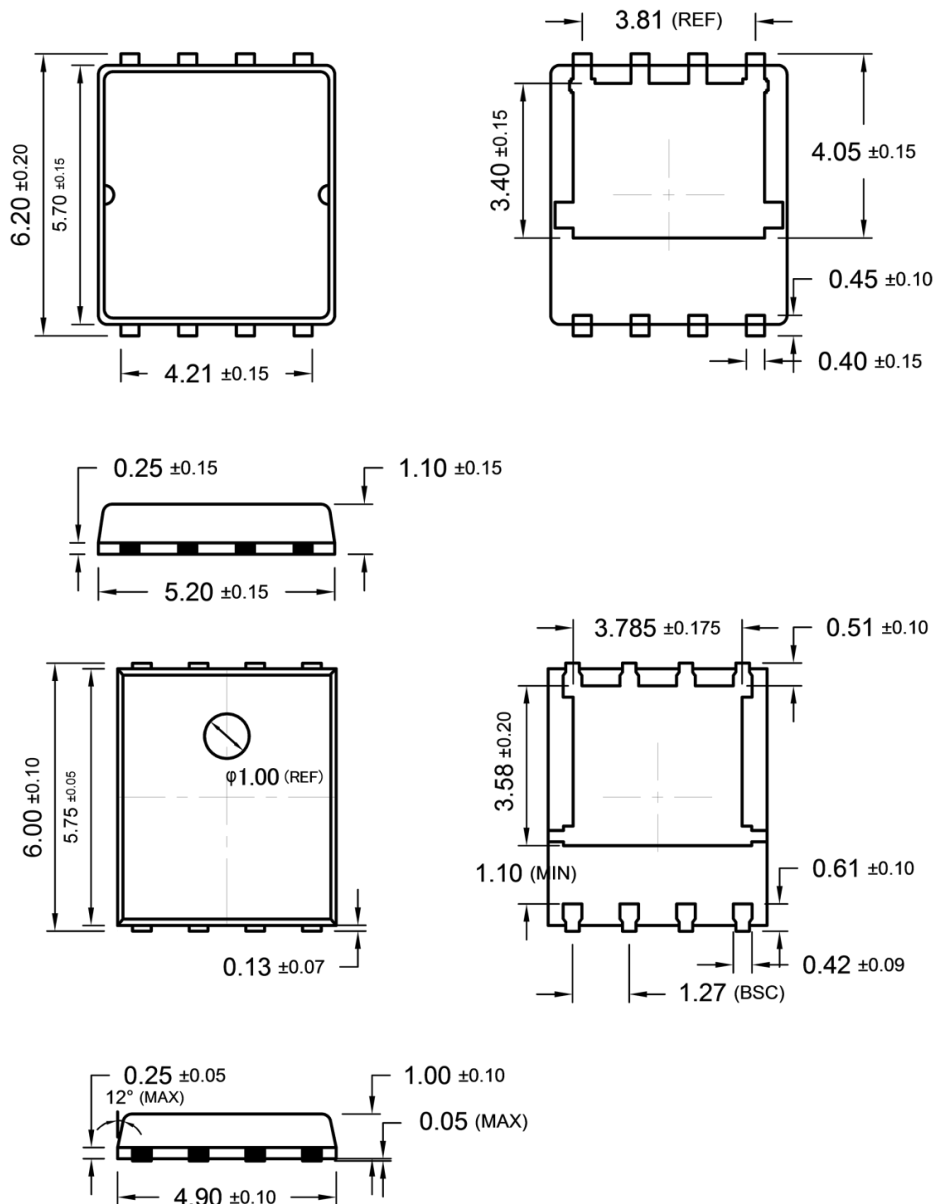

**SUGGESTED PAD LAYOUT** (Unit: Millimeters)



**MARKING DIAGRAM**

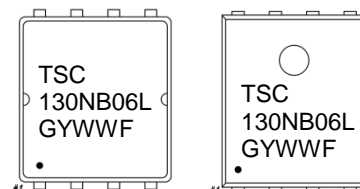

- G** = Halogen Free
- Y** = Year Code
- WW** = Week Code (01~52)
- F** = Factory Code

## Notice

Specifications of the products displayed herein are subject to change without notice. TSC or anyone on its behalf, assumes no responsibility or liability for any errors or inaccuracies.

Information contained herein is intended to provide a product description only. No license, express or implied, to any intellectual property rights is granted by this document. Except as provided in TSC's terms and conditions of sale for such products, TSC assumes no liability whatsoever, and disclaims any express or implied warranty, relating to sale and/or use of TSC products including liability or warranties relating to fitness for a particular purpose, merchantability, or infringement of any patent, copyright, or other intellectual property right.

The products shown herein are not designed for use in medical, life-saving, or life-sustaining applications. Customers using or selling these products for use in such applications do so at their own risk and agree to fully indemnify TSC for any damages resulting from such improper use or sale.