

EMILY-D

~11° diffused spot beam. 14.74 mm high lens.

TECHNICAL SPECIFICATIONS:

Dimensions	Ø 26.0 mm
Height	14.7 mm
Fastening	tape, pin
ROHS compliant	yes ⓘ

MATERIAL SPECIFICATIONS:

Component	Type	Material	Colour	Finish
EMILY-D	Single lens	PMMA		
SPUTNIK-TAPE	Tape	PU tape		



ORDERING INFORMATION:

Component	Type	Qty in box	MOQ	MPQ	Box weight (kg)
CA12062_EMILY-D » Box size: 480 x 280 x 300 mm	Single lens	1690	260	130	10.5

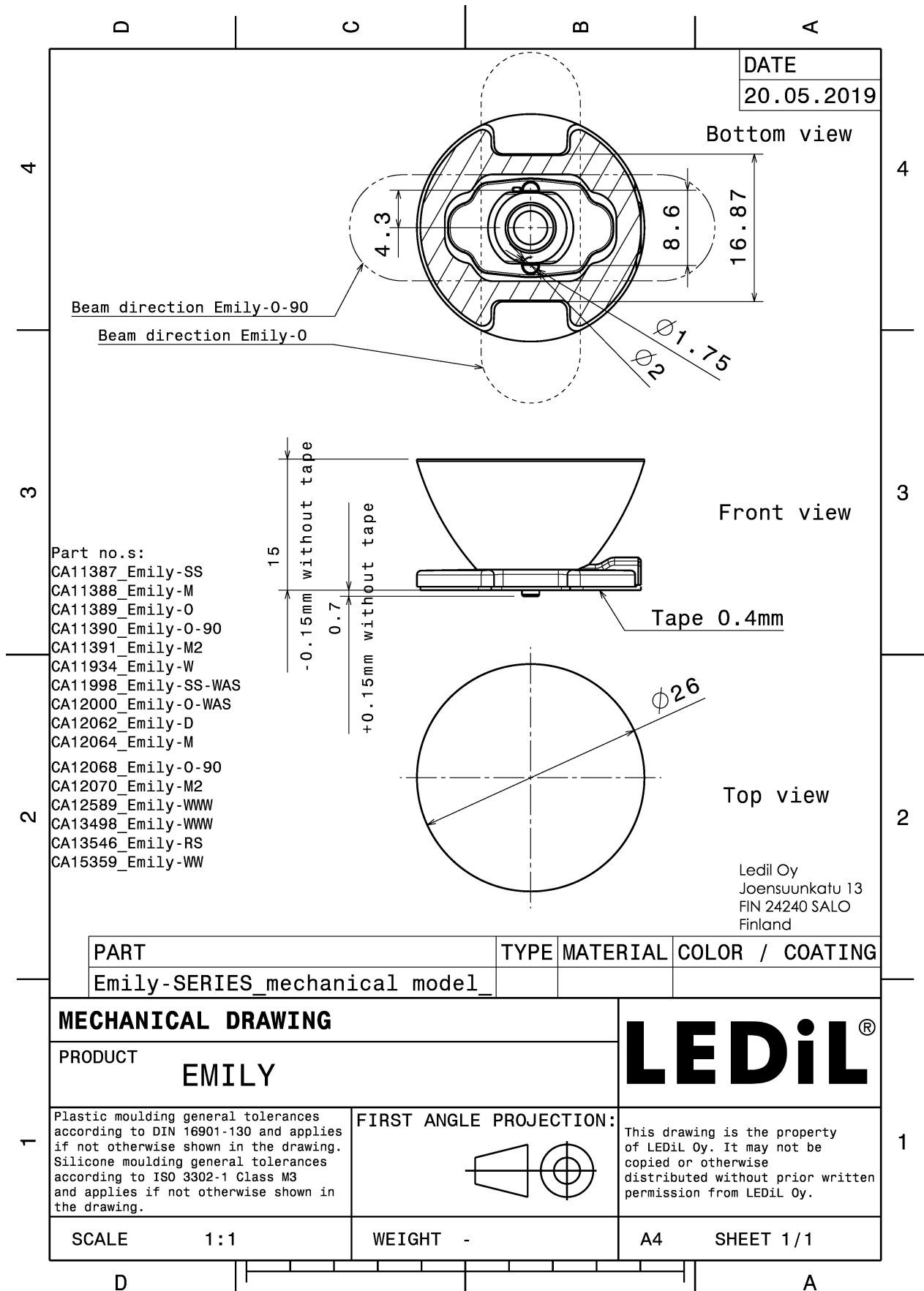

PHOTOMETRIC DATA (MEASURED):

CREE 

LED XB-H
 FWHM 10.0°
 Efficiency 89 %
 Peak intensity 17.500 cd/lm
 LEDs/each optic 1
 Light colour White
 Required components:

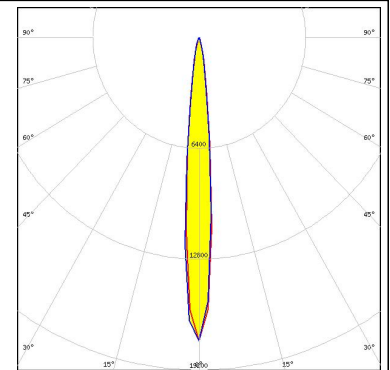

CREE 

LED XD16
 FWHM 8.0°
 Efficiency 92 %
 Peak intensity 18.400 cd/lm
 LEDs/each optic 1
 Light colour White
 Required components:

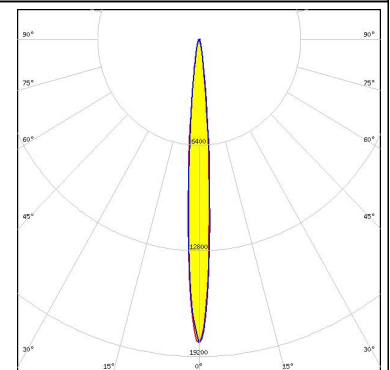

CREE 

LED XHP35 HI
 FWHM 11.0°
 Efficiency 92 %
 Peak intensity 14.500 cd/lm
 LEDs/each optic 1
 Light colour White
 Required components:

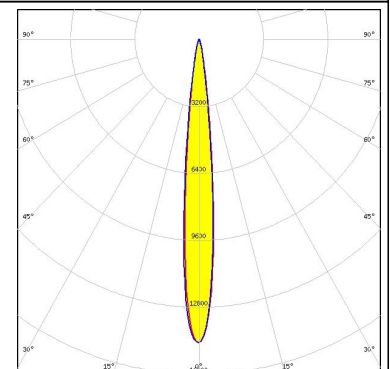
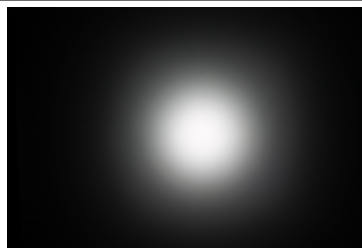

CREE 

LED XM-L
 FWHM 14.0°
 Efficiency 90 %
 Peak intensity 10.100 cd/lm
 LEDs/each optic 1
 Light colour White
 Required components:

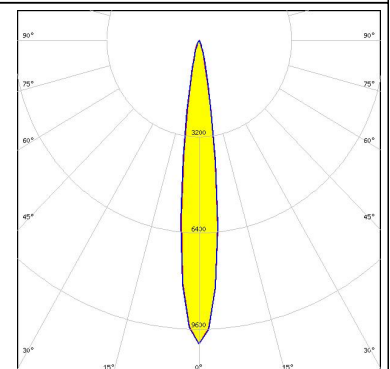

PHOTOMETRIC DATA (MEASURED):

CREE

LED XM-L2
 FWHM 14.0°
 Efficiency 90 %
 Peak intensity 10.200 cd/lm
 LEDs/each optic 1
 Light colour White
 Required components:

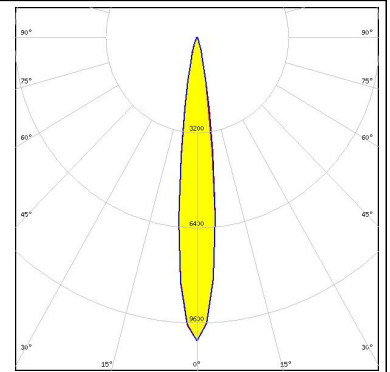

CREE

LED XP-E2
 FWHM 8.0°
 Efficiency 87 %
 Peak intensity 27.300 cd/lm
 LEDs/each optic 1
 Light colour White
 Required components:

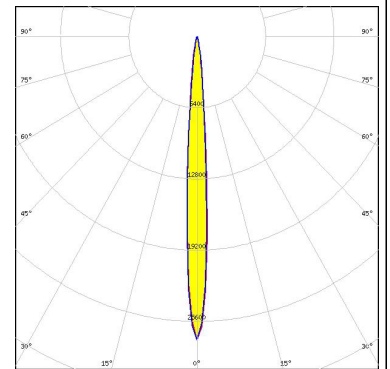

CREE

LED XP-G2
 FWHM 10.0°
 Efficiency 90 %
 Peak intensity 20.800 cd/lm
 LEDs/each optic 1
 Light colour White
 Required components:

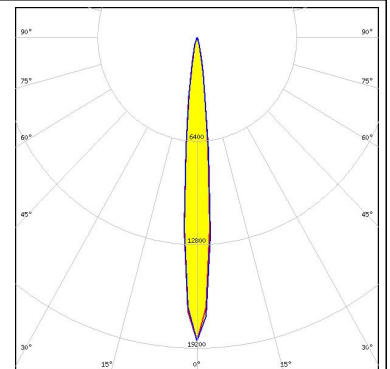

CREE

LED XP-G3
 FWHM 11.0°
 Efficiency 94 %
 Peak intensity 13.000 cd/lm
 LEDs/each optic 1
 Light colour White
 Required components:

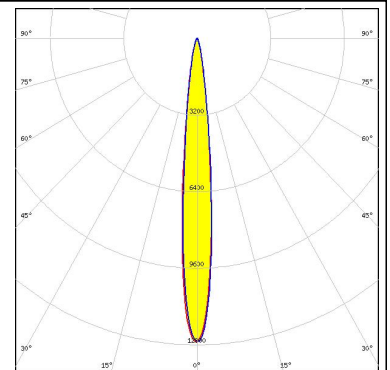

PHOTOMETRIC DATA (MEASURED):

CREE

LED XP-L HD
 FWHM 13.0°
 Efficiency 90 %
 Peak intensity 10.200 cd/lm
 LEDs/each optic 1
 Light colour White
 Required components:

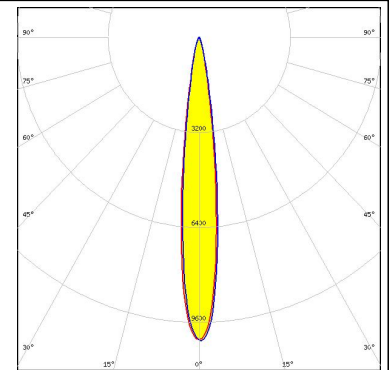

CREE

LED XP-L HI
 FWHM 9.0°
 Efficiency 87 %
 Peak intensity 20.000 cd/lm
 LEDs/each optic 1
 Light colour White
 Required components:

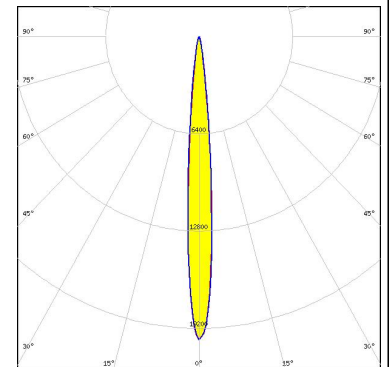

CREE

LED XT-E
 FWHM 9.0°
 Efficiency %
 Peak intensity 14.000 cd/lm
 LEDs/each optic 1
 Light colour White
 Required components:

LUMILEDS

LED LUXEON A
 FWHM 11.0°
 Efficiency 91 %
 Peak intensity cd/lm
 LEDs/each optic 1
 Light colour White
 Required components:

PHOTOMETRIC DATA (MEASURED):

LUMILEDS
 LED LUXEON Rebel ES
 FWHM 10.0°
 Efficiency 91 %
 Peak intensity cd/lm
 LEDs/each optic 1
 Light colour White
 Required components:

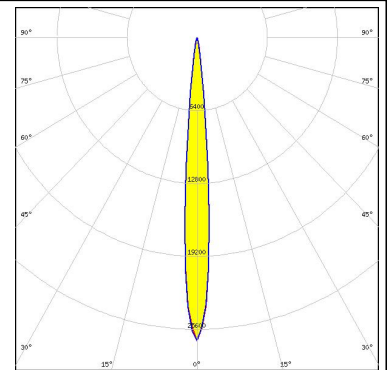

NICHIA
 LED NS9x383
 FWHM 14.0°
 Efficiency 90 %
 Peak intensity 7.900 cd/lm
 LEDs/each optic 1
 Light colour White
 Required components:

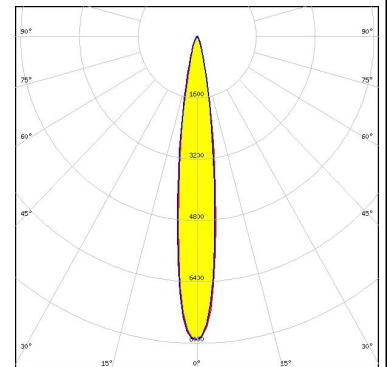

OSRAM
 Opto Semiconductors
 LED OSLOM Square EC
 FWHM 9.0°
 Efficiency 86 %
 Peak intensity 20.060 cd/lm
 LEDs/each optic 1
 Light colour White
 Required components:

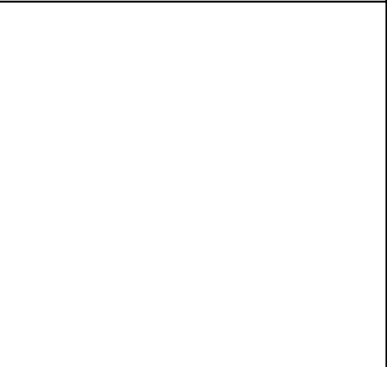
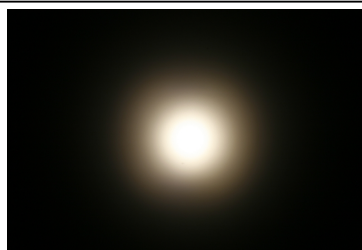

SAMSUNG
 LED LH351B
 FWHM 12.0°
 Efficiency 88 %
 Peak intensity 14.000 cd/lm
 LEDs/each optic 1
 Light colour White
 Required components:

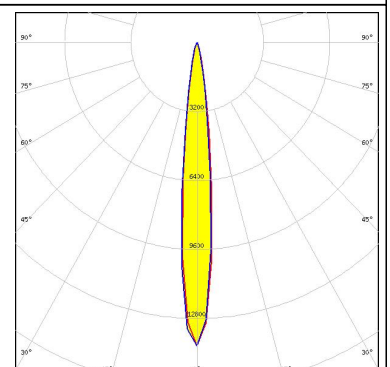

PHOTOMETRIC DATA (MEASURED):

SAMSUNG

LED LH351Z
 FWHM 10.0°
 Efficiency 88 %
 Peak intensity 20.000 cd/lm
 LEDs/each optic 1
 Light colour White
 Required components:

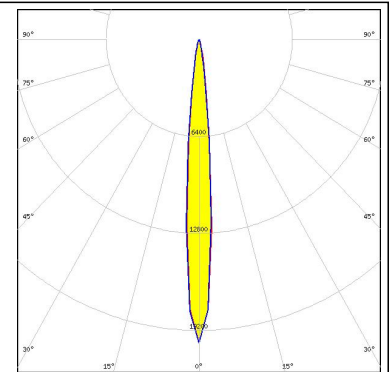

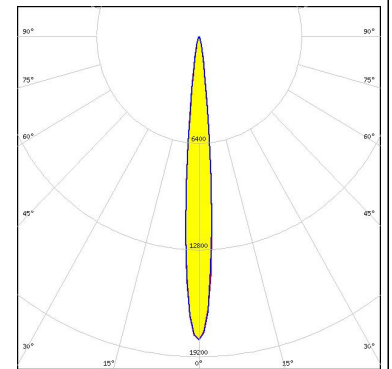

SEOUL SEMICONDUCTOR
 LED Z5M1/Z5M2
 FWHM 10.0°
 Efficiency 94 %
 Peak intensity 18.200 cd/lm
 LEDs/each optic 1
 Light colour White
 Required components:

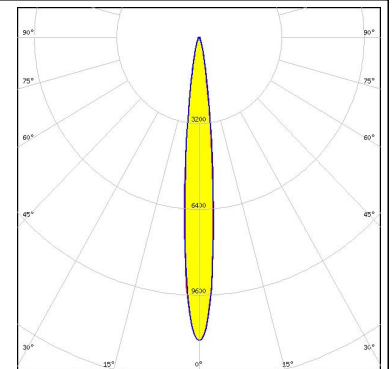

SEOUL SEMICONDUCTOR
 LED Z8Y22P
 FWHM 11.0°
 Efficiency 93 %
 Peak intensity 11.300 cd/lm
 LEDs/each optic 1
 Light colour White
 Required components:

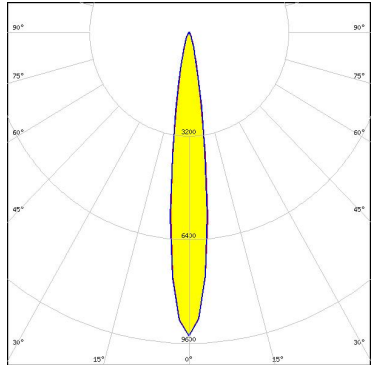

PHOTOMETRIC DATA (SIMULATED):

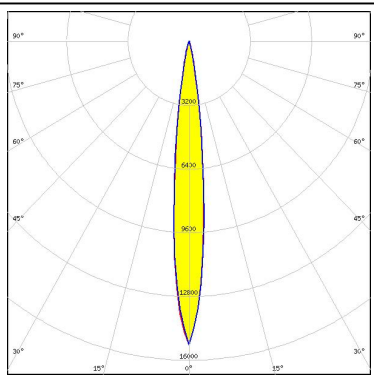
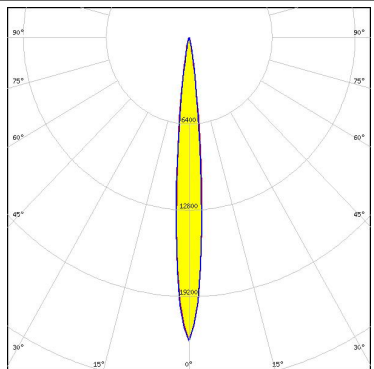
<p>CREE </p> <p>LED XM-L HVW FWHM 14.0° Efficiency % Peak intensity cd/lm LEDs/each optic 1 Light colour White Required components:</p>	
<p>CREE </p> <p>LED XP-G2 HE FWHM 12.0° Efficiency 95 % Peak intensity 15.232 cd/lm LEDs/each optic 1 Light colour White Required components:</p>	
<p>OSRAM <small>Opto Semiconductors</small></p> <p>LED OSLON Square CSSRM2/CSSRM3 FWHM 9.9° Efficiency 94 % Peak intensity 22.500 cd/lm LEDs/each optic 1 Light colour White Required components:</p>	

GENERAL INFORMATION:

NOTE: The typical beam angle will be changed by different color, chip size and chip position tolerance. The typical total beam angle is the full angle measured where the luminous intensity is half of the peak value.

MATERIALS:

As part of our continuous research and improvement processes, and to ensure the best possible quality and availability of our products, LEDiL reserves the right to change material grades without notice.

PRODUCT DATA USER AGREEMENT AND DISCLAIMER:

The measured data in the provided downloadable LEDiL Product Datasheets and Mechanical 2D-Drawings is rounded and provided as reference for planning. LEDiL Oy's optical specifications have been verified by conducting performance testing of the products in accordance with the company's quality system. The reported data are averaged results of multiple measurements with typical variation. LEDiL Oy reserves the right to without prior notification make changes and improvements to its products.

LEDiL Oy assumes neither warranty, nor guarantee nor any other liability of any kind for the contents and correctness of the provided data. The provided data has been generated with highest diligence but the provided data may in reality not represent the complete possible variation range of all intrinsic parameters. Therefore, in certain cases a deviation from the provided data could occur.

LEDiL Oy reserves the right to undertake technical changes of its products without further notification which could lead to changes in the provided data. LEDiL Oy assumes no liability of any kind for the possible deviation from any provided data or any other damage resulting from the usage of the provided data.

The user agrees to this disclaimer and user agreement with the download or usage of the provided files.

LEDiL Oy

Joensuunkatu 13
FI-24240 SALO
Finland

LEDiL Inc.

228 West Page Street
Suite D
Sycamore IL 60178
USA

Local sales and technical support

[www.ledil.com/
where_to_buy](http://www.ledil.com/where_to_buy)

Shipping locations

Salo, Finland
Hong Kong, China

Distribution Partners

[www.ledil.com/
where_to_buy](http://www.ledil.com/where_to_buy)