

RF360 Europe GmbH

A Qualcomm – TDK Joint Venture

## SAW Components

### SAW Duplexer for smallcells and femto-cells

Band 20 (LTE)

Series/type:	B8030
Ordering code:	B39851B8030P810
Date:	November 18, 2015
Version:	2.1

RF360 products mentioned within this document are offered by RF360 Europe GmbH and other subsidiaries of RF360 Holdings Singapore Pte. Ltd. (collectively, the “RF360 Subsidiaries”). RF360 Holdings Singapore Pte. Ltd. is a joint venture of Qualcomm Global Trading Pte. Ltd. and EPCOS AG. References in this documentation to EPCOS AG should properly reference, and shall be read to reference, the RF360 Subsidiaries.

RF360 Europe GmbH, Anzinger Str. 13, München, Germany

© 2016 RF360 Europe GmbH and/or its affiliated companies. All rights reserved.

These materials, including the information contained herein, may be used only for informational purposes by the customer. The RF360 Subsidiaries assume no responsibility for errors or omissions in these materials or the information contained herein. The RF360 Subsidiaries reserve the right to make changes to the product(s) or information contained herein without notice. The materials and information are provided on an AS IS basis, and the RF360 Subsidiaries assume no liability and make no warranty or representation, either expressed or implied, with respect to the materials, or any output or results based on the use, application, or evaluation of such materials, including, without limitation, with respect to the non-infringement of trademarks, patents, copyrights or any other intellectual property rights or other rights of third parties.

No use of this documentation or any information contained herein grants any license, whether express, implied, by estoppel or otherwise, to any intellectual property rights, including, without limitation, to any patents owned by QUALCOMM Incorporated or any of its subsidiaries.

Not to be used, copied, reproduced, or modified in whole or in part, nor its contents revealed in any manner to others without the express written permission of RF360 Europe GmbH.

Qualcomm and Qualcomm RF360 are trademarks of Qualcomm Incorporated, registered in the United States and other countries. RF360 is a trademark of Qualcomm Incorporated. Other product and brand names may be trademarks or registered trademarks of their respective owners.

This technical data may be subject to U.S. and international export, re-export, or transfer ("export") laws. Diversion contrary to U.S. and international law is strictly prohibited.



# SAW Components

## SAW Duplexer for smallcells and femto-cells

Band 20 (LTE)

<b>Series/type:</b>	<b>B8030</b>
<b>Ordering code:</b>	<b>B39851B8030P810</b>
<b>Date:</b>	<b>November 18, 2015</b>
<b>Version:</b>	<b>2.1</b>

© EPCOS AG 2015. Reproduction, publication and dissemination of this data sheet, enclosures hereto and the information contained therein without EPCOS' prior express consent is prohibited.

EPCOS AG is a TDK Group Company.

Data sheet

**Application**

- Low-loss SAW duplexer for LTE smallcells systems (Band 20)
- Usable passband 30MHz
- High power durability in downlink
- TX = DOWNLINK = 791-821MHz
- RX = UPLINK = 832-862MHz

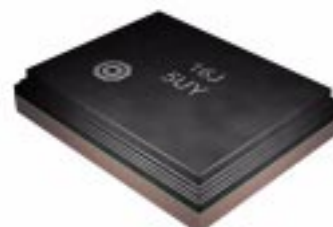
**Features**

- Package size 2.5 x 2.0 mm<sup>2</sup>
- Max. package height 0.5mm
- RoHS compatible
- Package for **Surface Mount Technology (SMT)**
- Ni, gold-plated terminals
- **Electrostatic Sensitive Device (ESD)**
- **Moisture Sensitivity Level 2a**

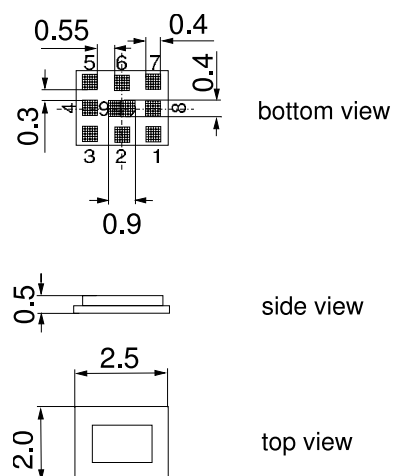
**Pin configuration**

- 1 Tx input
- 3 Rx output
- 6 Antenna
- 2, 4, 5, 7, 8, 9 To be grounded

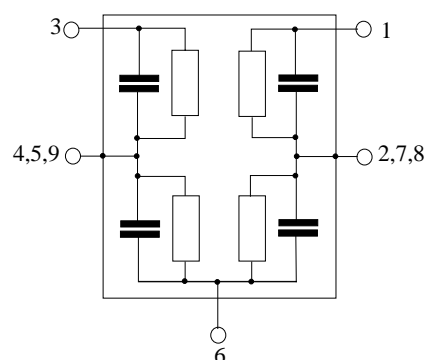

Data sheet

**Characteristics**

Temperature range for specification:	T = -10 °C to +85 °C
TX terminating impedance:	Z <sub>Tx</sub> = 50 Ω
ANT terminating impedance:	Z <sub>Ant</sub> = 50 Ω
RX terminating impedance:	Z <sub>Rx</sub> = 50 Ω

Characteristics Tx-Antenna		min.	typ. @ 25 °C	max.	
<b>Center frequency</b>	f <sub>c</sub>	—	806.0	—	MHz
<b>Maximum insertion attenuation</b>	α				
	791.0 ... 821.0 MHz	—	2.8	3.8	dB
<b>Amplitude ripple (p-p)</b>	Δα				
	791.0 ... 821.0 MHz	—	1.6	2.6	dB
<b>Error Vector Magnitude</b>					
@f <sub>Carrier</sub>	793.4 ... 818.6 MHz	—	3.5	6.0	%
<b>VSWR (Tx port)</b>					
	791.0 ... 821.0 MHz	—	1.8	2.3	
<b>VSWR (Ant port)</b>					
	791.0 ... 821.0 MHz	—	1.9	2.1	
<b>Absolute attenuation</b>	α <sub>abs</sub>				
	100.0 ... 750.0 MHz	30	39	—	dB
	832.0 ... 862.0 MHz	39	50	—	dB
	880.0 ... 915.0 MHz	30	42	—	dB
	925.0 ... 960.0 MHz	30	41	—	dB
	1574.0 ... 1785.0 MHz	40	49	—	dB
	1805.0 ... 1980.0 MHz	40	55	—	dB
	2110.0 ... 2170.0 MHz	40	52	—	dB
	2373.0 ... 2484.0 MHz	30	39	—	dB
	2496.0 ... 2570.0 MHz	40	46	—	dB
	2620.0 ... 2690.0 MHz	40	45	—	dB

1) Error Vector Magnitude (EVM) based on definition given in 3GPP TS 25.141.

Data sheet

**Characteristics**

Temperature range for specification:	T = -10 °C to +85 °C
TX terminating impedance:	Z <sub>Tx</sub> = 50 Ω
ANT terminating impedance:	Z <sub>Ant</sub> = 50 Ω
RX terminating impedance:	Z <sub>Rx</sub> = 50 Ω

Characteristics Antenna-Rx		min.	typ. @ 25 °C	max.	
<b>Center frequency</b>	f <sub>c</sub>	—	847.0	—	MHz
<b>Maximum insertion attenuation</b> 832.0 ... 862.0 MHz	α	—	2.9	3.8	dB
<b>Amplitude ripple (p-p)</b> 832.0 ... 862.0 MHz	Δα	—	1.8	2.6	dB
<b>Error Vector Magnitude</b> @f <sub>Carrier</sub> 834.4 ... 859.6 MHz	EVM <sup>1)</sup>	—	4.5	6.0	%
<b>VSWR (Ant port)</b> 832.0 ... 862.0 MHz		—	1.6	2.0	
<b>VSWR (Rx port)</b> 832.0 ... 862.0 MHz		—	1.7	2.2	
<b>Absolute attenuation</b>	α <sub>abs</sub>				
100.0 ... 791.0 MHz		35	37	—	dB
791.0 ... 821.0 MHz		44	46	—	dB
880.0 ... 915.0 MHz		20	42	—	dB
1000.0 ... 2200.0 MHz		30	37	—	dB
2200.0 ... 2700.0 MHz		30	39	—	dB
2700.0 ... 4000.0 MHz		30	46	—	dB

1) Error Vector Magnitude (EVM) based on definition given in 3GPP TS 25.141.

Data sheet

**Characteristics**

Temperature range for specification:	$T = -10\text{ °C to }+85\text{ °C}$
TX terminating impedance:	$Z_{Tx} = 50\ \Omega$
ANT terminating impedance:	$Z_{Ant} = 50\ \Omega$
RX terminating impedance:	$Z_{Rx} = 50\ \Omega$

Characteristics Tx-Rx		min.	typ. @ 25 °C	max.	
<b>Isolation</b>	$\alpha$				
	791.0 ... 821.0 MHz	44	46	—	dB
	832.0 ... 862.0 MHz	42	53	—	dB

**Maximum Ratings**

Storage temperature range	$T_{stg}$	-40/+85	°C	
DC voltage	$V_{DC}$	0	V	
ESD voltage	$V_{ESD}$	100 <sup>1)</sup>	V	machine model, 1 pulse
Input power at pin 1				source and load impedance 50 $\Omega$
791.0 ...821.0 MHz	$P_{in}$	28 <sup>2)</sup>	dBm	} $P_{in}$ 28dBm average - 39dBm peak LTE 5 MHz downlink $T = 55\text{ °C}$ , 100 000 hrs
elsewhere	$P_{in}$	10	dBm	
832.0 ...862.0 MHz	$P_{in}$	29 <sup>3)</sup>	dBm	$P_{in}$ 29dBm average, LTE 5 MHz Uplink, $T = 55\text{ °C}$ , 5 000 hrs
Operating lifetime with Output power at antenna				source and load impedance 50 $\Omega$
791.0 ...821.0 MHz		$T_{bc}$ <sup>4)</sup>	dBm	Continuous wave $T = 55\text{ °C}$ , 100k hrs

1) According to JESD22-A115B (machine model), 1 negative and 1 positive pulse.

2) Time to failure (TTF) according to accelerated power durability tests, and wear out models.

3) Time to failure (TTF) according to accelerated power durability simulations acc. to wear out models.

4) values to be confirm from High Temperature Operating Life (HTOL) test.

Data sheet

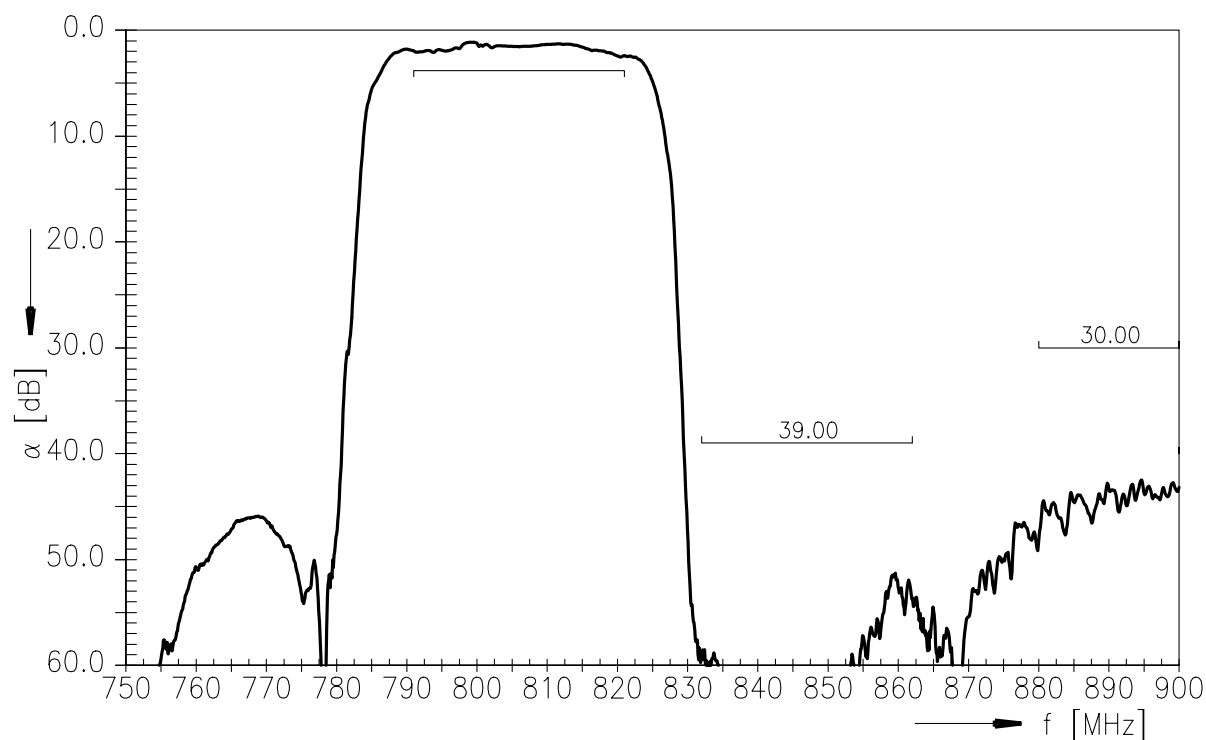
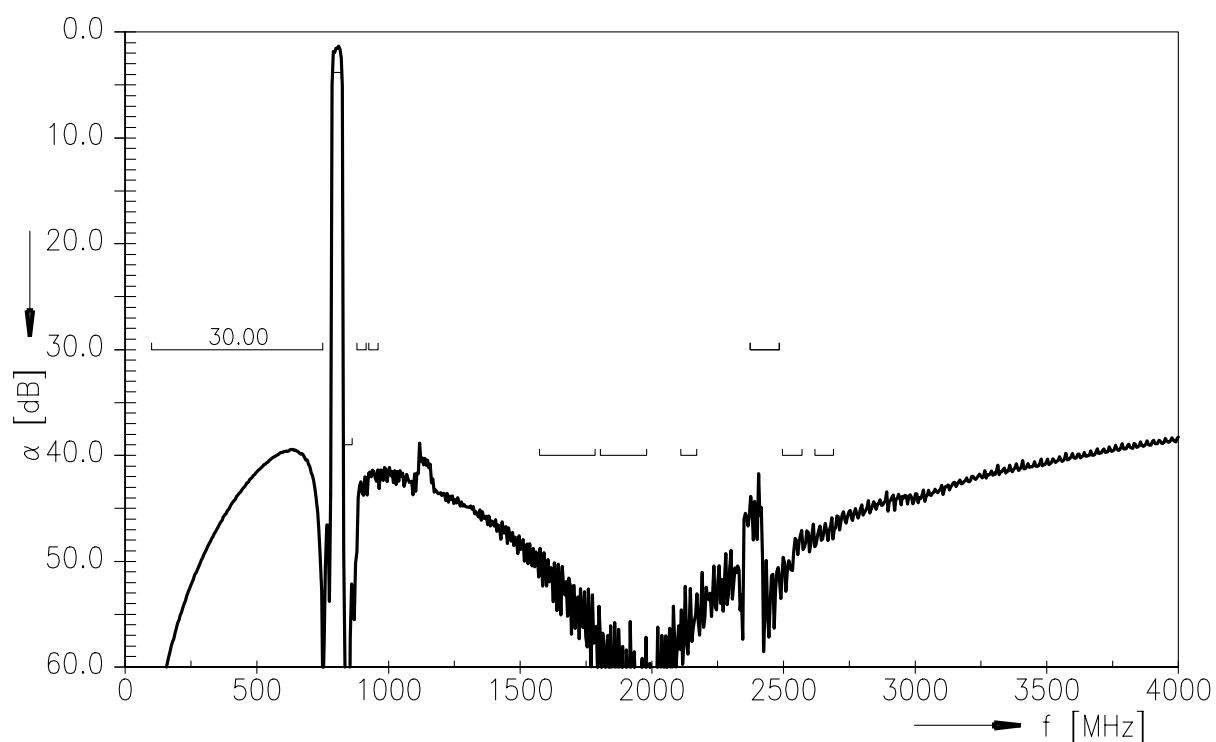
**Frequency response TX-ANT**

**Frequency response TX-ANT (wideband)**



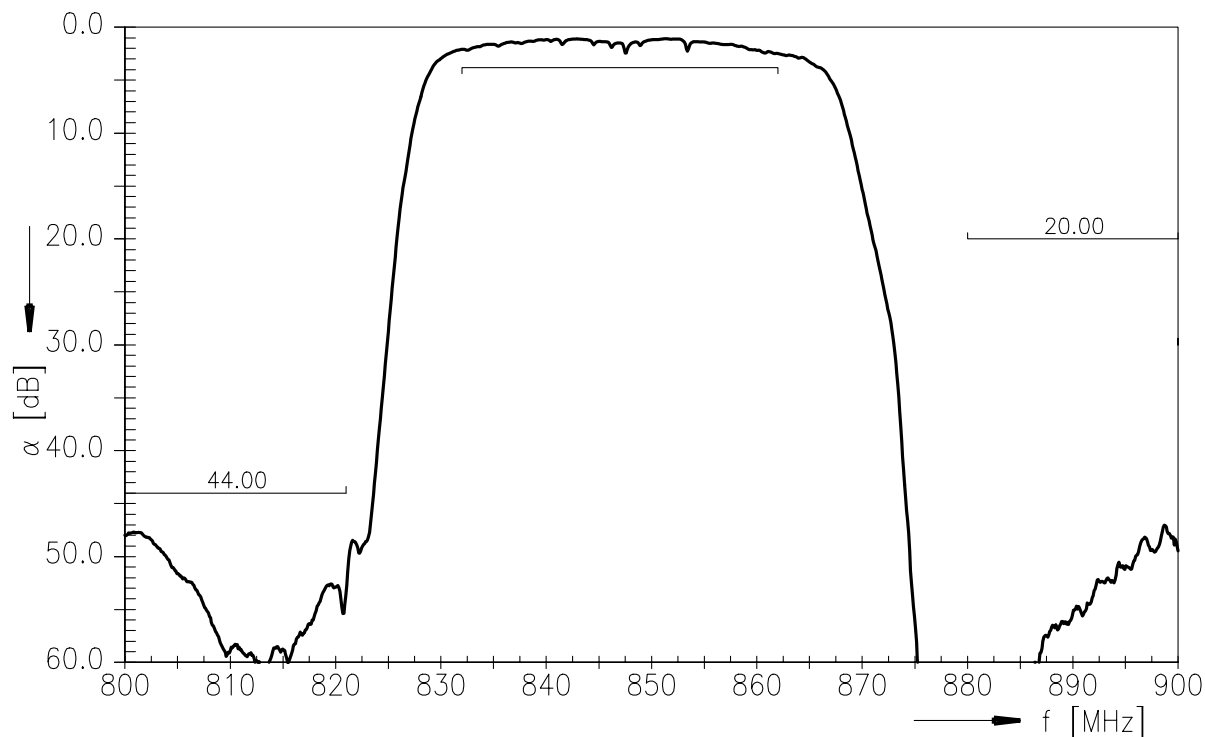

Frequency response ANT-RX



Frequency response ANT-RX (wideband)

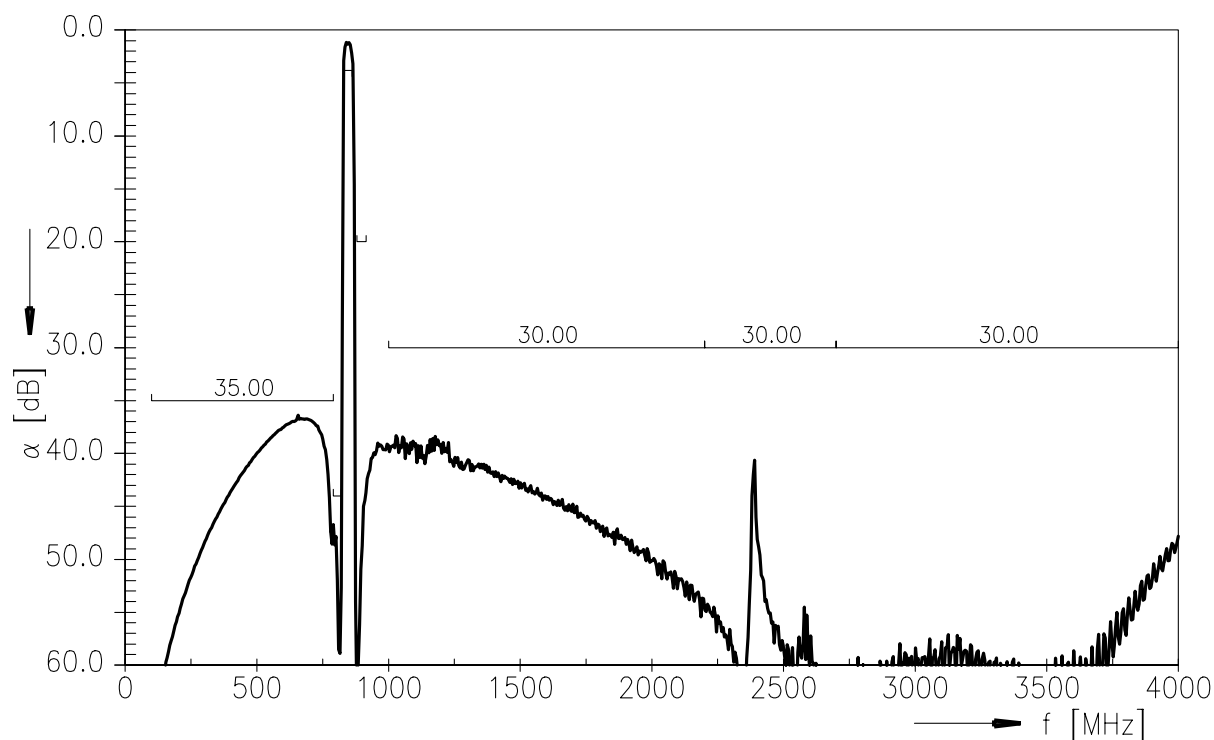

Data sheet

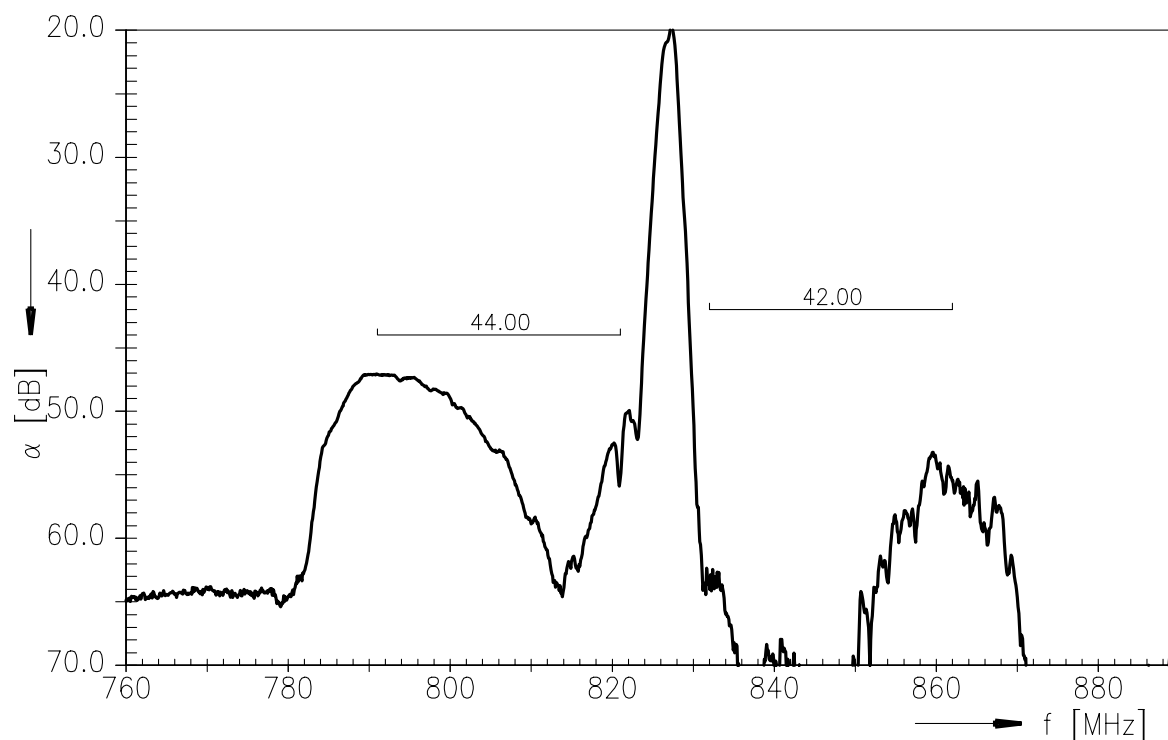
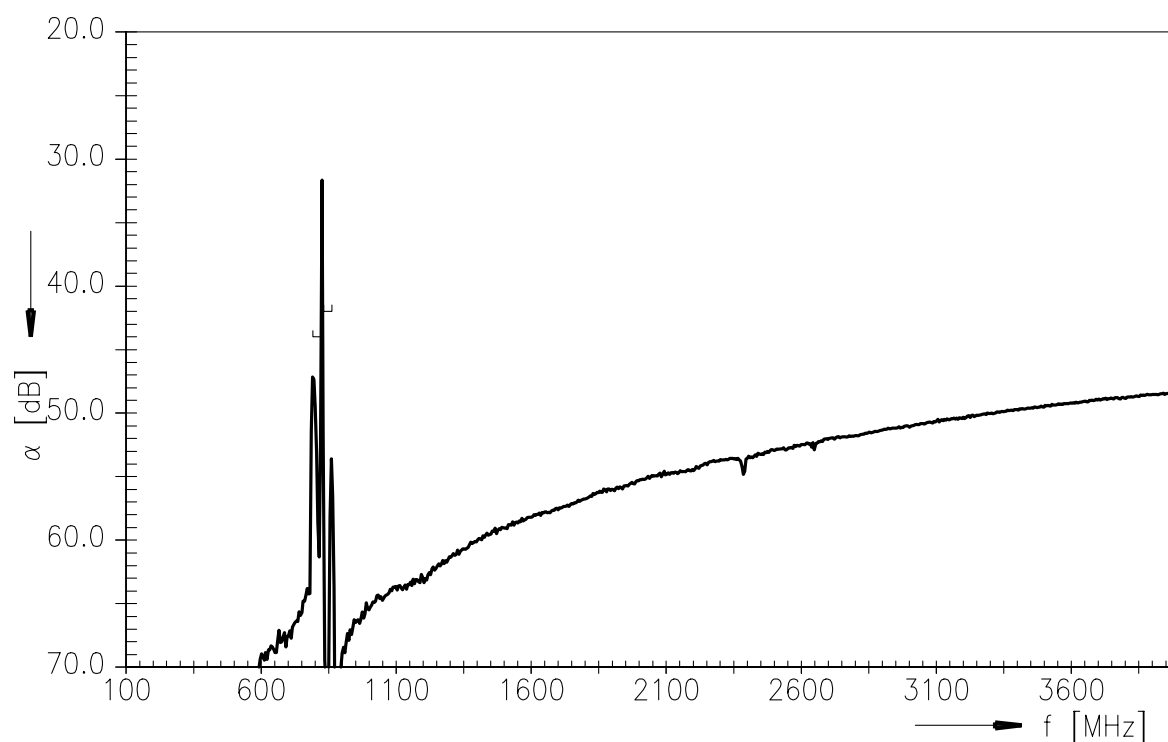
**Frequency response TX-RX**

**Frequency response TX-RX (wideband)**

Data sheet



Return Loss

$S_{11}$  TX- port

$S_{22}$  ANT-port

$S_{33}$  RX-port

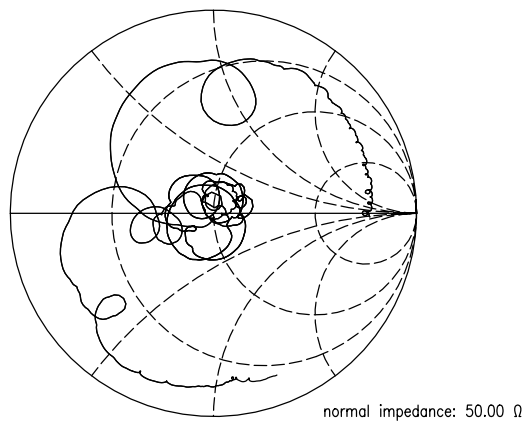
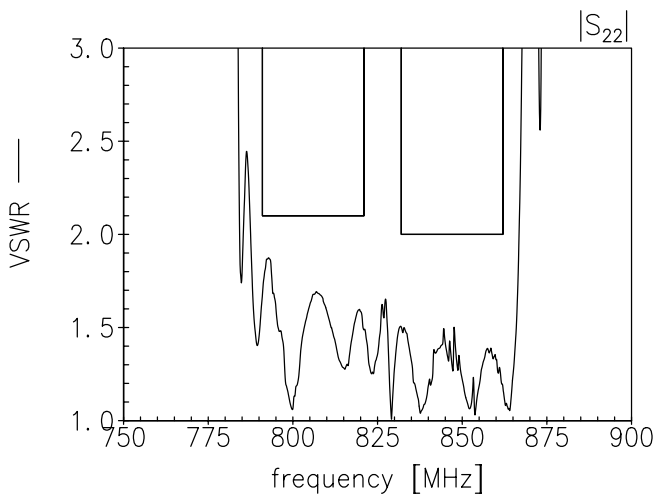
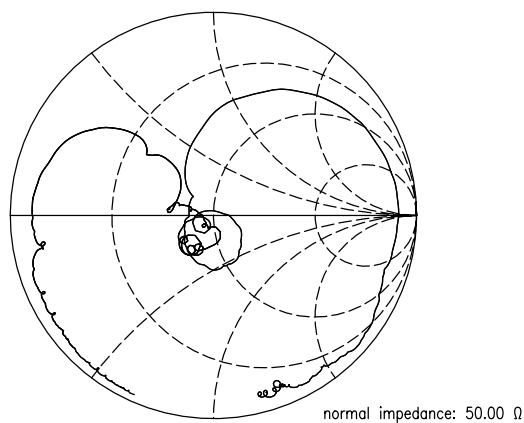
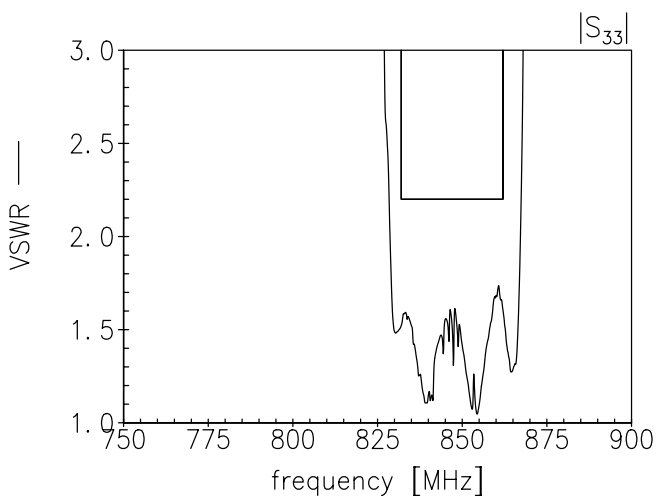
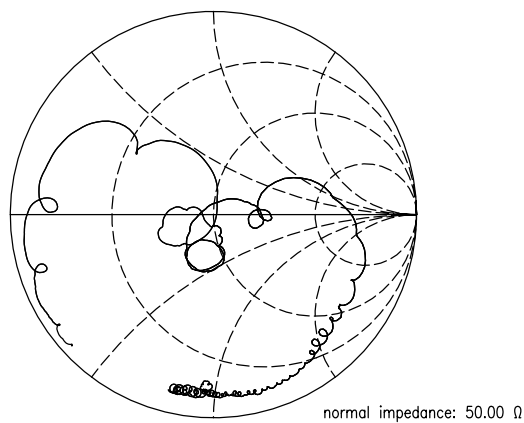
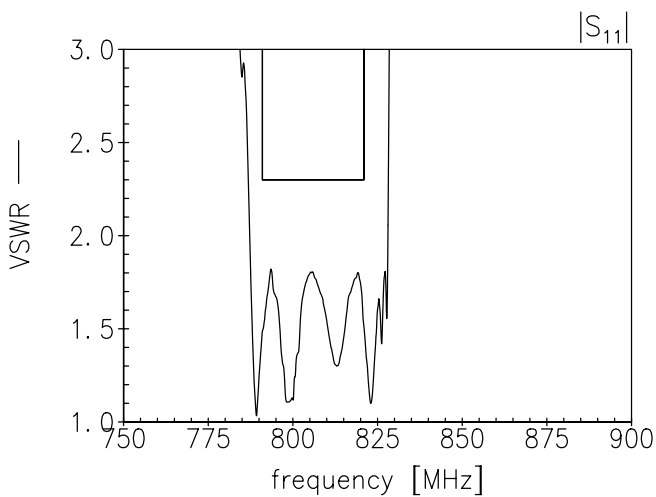

**References**

<b>Type</b>	B8030
<b>Ordering code</b>	B39851B8030P810
<b>Marking and package</b>	C61157-A3-A27
<b>Packaging</b>	F61074-V8232-Z000
<b>Date codes</b>	L_1126
<b>S-parameters</b>	B8030_NB.s3p , B8030_WB.s3p See file header for port/pin assignment table.
<b>Soldering profile</b>	S_6001
<b>RoHS compatible</b>	RoHS-compatible means that products are compatible with the requirements according to Art. 4 (substance restrictions) of Directive 2011/65/EU of the European Parliament and of the Council of June 8 <sup>th</sup> , 2011, on the restriction of the use of certain hazardous substances in electrical and electronic equipment ("Directive") with due regard to the application of exemptions as per Annex III of the Directive in certain cases.
<b>Moldability</b>	Before using in overmolding environment, please contact your EPCOS sales office.
<b>Matching coils</b>	See Inductor pdf-catalog <a href="http://www.tdk.co.jp/tefe02/coil.htm#aname1">http://www.tdk.co.jp/tefe02/coil.htm#aname1</a> and Data Library for circuit simulation <a href="http://www.tdk.co.jp/etvcl/index.htm">http://www.tdk.co.jp/etvcl/index.htm</a> for a large variety of matching coils.

For further information please contact your local EPCOS sales office or visit our webpage at [www.epcos.com](http://www.epcos.com) .

**Published by EPCOS AG**  
**Systems, Acoustics, Waves Business Group**  
**P.O. Box 80 17 09, 81617 Munich, GERMANY**

© EPCOS AG 2015. This brochure replaces the previous edition.

For questions on technology, prices and delivery please contact the Sales Offices of EPCOS AG or the international Representatives.

Due to technical requirements components may contain dangerous substances. For information on the type in question please also contact one of our Sales Offices.

## Important notes

The following applies to all products named in this publication:

1. Some parts of this publication contain **statements about the suitability of our products for certain areas of application**. These statements are based on our knowledge of typical requirements that are often placed on our products in the areas of application concerned. We nevertheless expressly point out **that such statements cannot be regarded as binding statements about the suitability of our products for a particular customer application**. As a rule, EPCOS is either unfamiliar with individual customer applications or less familiar with them than the customers themselves. For these reasons, it is always ultimately incumbent on the customer to check and decide whether an EPCOS product with the properties described in the product specification is suitable for use in a particular customer application.
2. We also point out that **in individual cases, a malfunction of electronic components or failure before the end of their usual service life cannot be completely ruled out in the current state of the art, even if they are operated as specified**. In customer applications requiring a very high level of operational safety and especially in customer applications in which the malfunction or failure of an electronic component could endanger human life or health (e.g. in accident prevention or life-saving systems), it must therefore be ensured by means of suitable design of the customer application or other action taken by the customer (e.g. installation of protective circuitry or redundancy) that no injury or damage is sustained by third parties in the event of malfunction or failure of an electronic component.
3. **The warnings, cautions and product-specific notes must be observed.**
4. In order to satisfy certain technical requirements, **some of the products described in this publication may contain substances subject to restrictions in certain jurisdictions (e.g. because they are classed as hazardous)**. Useful information on this will be found in our Material Data Sheets on the Internet ([www.epcos.com/material](http://www.epcos.com/material)). Should you have any more detailed questions, please contact our sales offices.
5. We constantly strive to improve our products. Consequently, **the products described in this publication may change from time to time**. The same is true of the corresponding product specifications. Please check therefore to what extent product descriptions and specifications contained in this publication are still applicable before or when you place an order. We also **reserve the right to discontinue production and delivery of products**. Consequently, we cannot guarantee that all products named in this publication will always be available. The aforementioned does not apply in the case of individual agreements deviating from the foregoing for customer-specific products.
6. Unless otherwise agreed in individual contracts, **all orders are subject to the current version of the “General Terms of Delivery for Products and Services in the Electrical Industry” published by the German Electrical and Electronics Industry Association (ZVEI)**.
7. The trade names EPCOS, Alu-X, CeraDiode, CeraLink, CeraPad, CeraPlas, CSMP, CSSP, CTVS, DeltaCap, DigiSiMic, DSSP, ExoCore, FilterCap, FormFit, LeaXield, MiniBlue, MiniCell, MKD, MKK, MotorCap, PCC, PhaseCap, PhaseCube, PhaseMod, PhiCap, PQSine, SIFERRIT, SIFI, SIKOREL, SilverCap, SIMDAD, SiMic, SIMID, SineFormer, SIOV, SIP5D, SIP5K, TFAP, ThermoFuse, WindCap are **trademarks registered or pending** in Europe and in other countries. Further information will be found on the Internet at [www.epcos.com/trademarks](http://www.epcos.com/trademarks).

# Mouser Electronics

Authorized Distributor

Click to View Pricing, Inventory, Delivery & Lifecycle Information:

[Qualcomm RF360:](#)

[B39851B8030P810](#)