

Accessories Multimode Relay MT

- Snap-on mounting on DIN-rail
- Screw mounting
- Pozidrive screws with rising clamp terminals
- Logical layout of input-/output connections
- White marking area

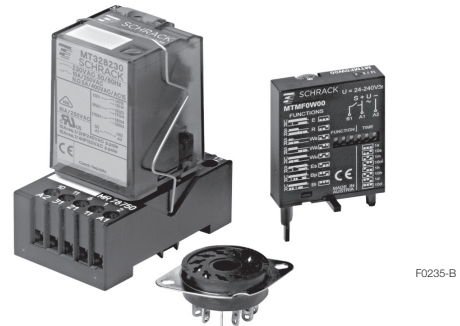

MT DIN-rail sockets with screw-type terminals

- MT 78 750** MT3 DIN-rail socket with screw-type terminals, 11-pin
- MT 78 755** MT2 DIN-rail socket with screw-type terminals, 8-pin

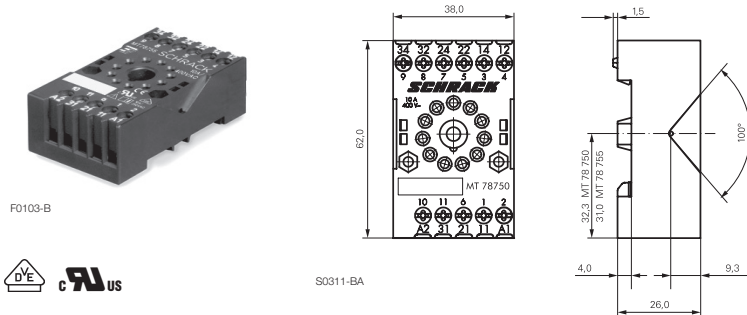

- MT78 760** MT3 DIN-rail socket with screw-type terminals, 11-pin

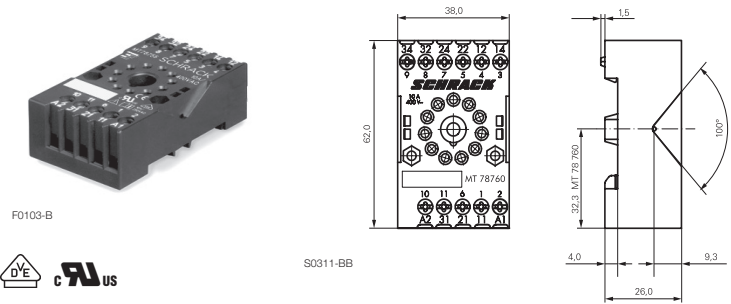

- MT 78 740** MT3 DIN-rail socket with screw-type terminals, 11-pin
- MT 78 745** MT2 DIN-rail socket with screw-type terminals, 8-pin

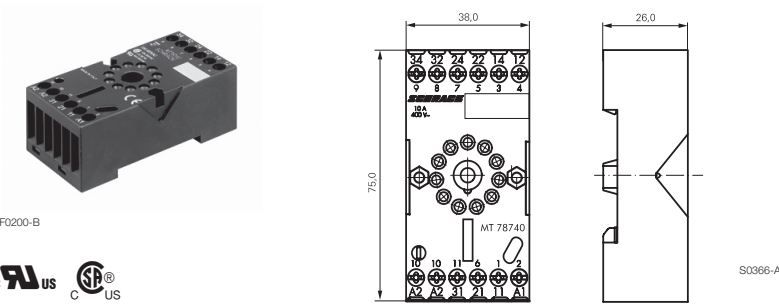

Socket system MT 78 740 and MT 78 745

- 8/11 pin socket for MT2 / MT3
- Double A2 screw for simple further connection of coil supply

Accessories Multimode Relay MT (Continued)

Approvals

VDE Cert. No. 40009096, cULus E135149

Technical data MT78 750/755/760/740/745

Rated voltage/Max. switching voltage AC	240/400 VAC
Rated current	10 A
Dielectric strength	
coil-contact circuit	2500 V _{rms}
open contact circuit	1500 V _{rms}
adjacent contact circuit	2500 V _{rms}
Clearance / creepage coil-contact circuit	≥ 2.8/4 mm
Material group of insulation parts	IIIa
Insulation to IEC 60664-1	
Type of insulation coil-contact circuit	basic
open contact circuit	functional
adjacent contact circuits	basic
Rated insulation voltage	250 V
Pollution degree	2
Rated voltage system	230/400 V
Overvoltage category	III
Material compliance: EU RoHS/ELV, China RoHS, REACH, Halogen content refer to the Product Compliance Support Center at www.te.com/customer-support/rohssupportcenter	
Ambient temperature range	-20...+80°C
Terminals	screw
Terminal screw torque acc. IEC 61984	0.5 Nm
max.	0.7 Nm
Wire cross section	
single wire	2 x 2.5 mm ²
fine wire	2 x 2.5 mm ²
with bootlace crimp (DIN 46228/1)	2 x 1.5 mm ²
Insertion cycles	A (10)
Max. Insertion Force total	100 N
Mounting distance	≥ 0 mm, dense packing
Weight	
MT 78 750/760	54 g
MT 78 755	47 g
MT 78 740	62 g
MT 78 745	56 g
Packaging unit	25 pcs

DIN-rail sockets with screw-type terminals

Type	Part Number
MT 78 750 DIN-rail socket with screw-type terminals, 11-pin	1415035-1
MT 78 755 DIN-rail socket with screw-type terminals, 8-pin	3-1415035-1
MT 78 760 DIN-rail socket with screw-type terminals, 11-pin	8-1415034-1
MT 78 740 DIN-rail socket with screw-type terminals, 11-pin	8-1393163-3
MT 78 745 DIN-rail socket with screw-type terminals, 8-pin	8-1393163-4

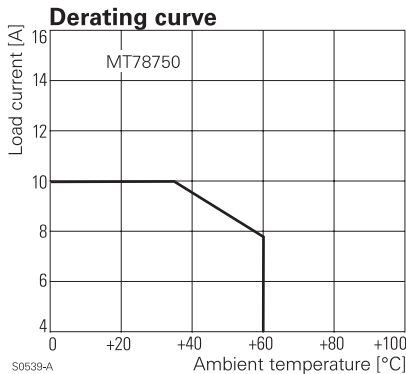

Accessories for MT 78 750, MT 78 755, MT 78 760, MT 78 740, MT 78 745

Type	Part Number
MT 28 800 Metal retaining clip MT	8-1393163-0

LED and Protection modules for MT 78 740, MT 78 745

Type	Part Number
MTM TO 0A0 Protection diode 1N4007 (A1+, A2-)	7-1393163-6
MTM U0 730 RC-network 110...230 VAC	7-1393163-8
MTM LO 024 red LED 24 VAC / VDC	7-1393163-4



F0201-B

Function modules for MT 78 740, MT 78 745

Type	Part Number
MTM ZO W00 Delay ON	7-1393163-9
MTM FO W00 Multifunction	7-1393163-3



F0203-B



F0204-B

Technical data - Function modules

Nominal voltage	24...240 VDC / VAC
Mains frequency	48...63 Hz
Precision of time setting	+ 0.5 %
Readiness for repetition	≤ 0.5 % or 5 ms
Influence of temperature	≤ 0.1 %/°C
Time range switchable	0.05s...240h in 8 ranges
Material compliance: EU RoHS/ELV, China RoHS, REACH, Halogen content refer to the Product Compliance Support Center at www.te.com/customer-support/rohssupportcenter	
Ambient temperature range	-25...+55°C

Accessories Multimode Relay MT (Continued)

Function modules for MT 78 740, MT 78 745

Function Delay ON	
Delay OFF	
single shot leading edge	
single shot trailing edge	
Delay ON triggered by signal contact	
single shot	
flasher starting with pause	
flasher starting with pulse	

**MT Sockets for PCB and with solder terminals
MT 78 602/603/612/613**

MT 78 612 Socket 8-pin with solder terminals

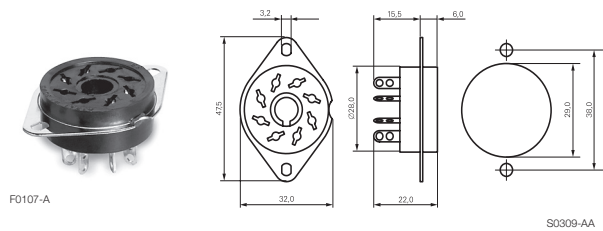

MT 78 613 Socket 11-pin with solder terminals

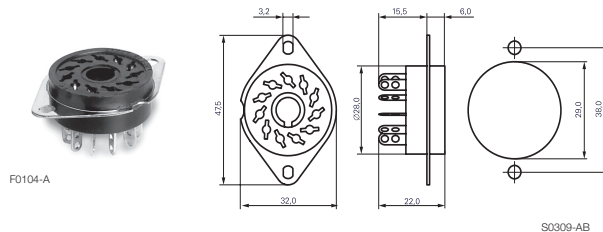

MT Sockets for PCB and with solder terminals

MT 78 602/603/612/613 (continued)

MT 78 602 Socket 8-pin with PCB terminals

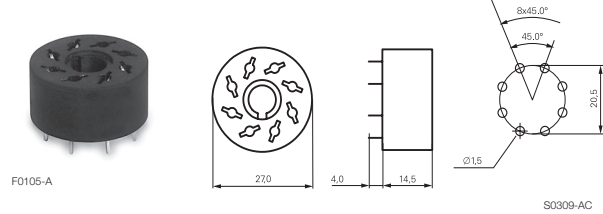

MT 78 603 Socket 11-pin with PCB terminals

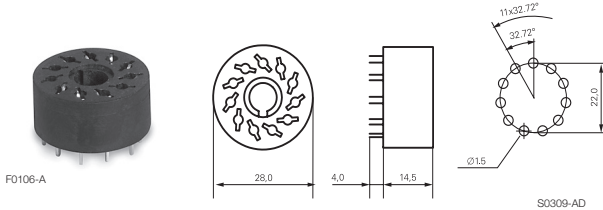

Technical data MT78 602/603/612/613

Rated voltage/Max. switching voltage AC	240/400 VAC
Rated current	10 A
Dielectric strength	
coil-contact circuit	2500 V _{rms}
open contact circuit	1500 V _{rms}
adjacent contact circuits	2500 V _{rms}
Clearance / creepage coil-contact circuit	≥ 2.8/4 mm
Material group of insulation parts	IIIa
Insulation to IEC 60664-1	
Type of insulation coil-contact circuit	basic
open contact circuit	functional
adjacent contact circuits	basic
Rated insulation voltage	250 V
Pollution degree	2
Rated voltage system	230/400 V
Overvoltage category	III

Material compliance: EU RoHS/ELV, China RoHS, REACH, Halogen content refer to the Product Compliance Support Center at www.te.com/customer-support/rohssupportcenter

Ambient temperature range	-40...+70°C
Terminals	pcb, solder terminals
Insertion cycles	A (10)
Max. Insertion Force total	100 N
Mounting distance	≥ 0 mm, dense packing
Resistance to soldering heat	270°C/10s
Weight	7 g
Packaging unit	25 pcs

Sockets with solder and PCB terminals

Type	Part Number
MT 78 612 Socket 8-pin with solder terminals	7-1415043-1
MT 78 613 Socket 11-pin with solder terminals	8-1415043-1
MT 78 602 Socket 8-pin with PCB terminals	9-1415043-1
MT 78 603 Socket 11-pin with PCB terminals	1415044-1