

## TINA2-D

~16° diffused spot beam optimized for CREE XP-E. Assembly with holder and installation tape.

### TECHNICAL SPECIFICATIONS:

Dimensions	Ø 16.1 mm
Height	9.7 mm
Fastening	tape
ROHS compliant	yes ⓘ

### MATERIAL SPECIFICATIONS:

Component	Type	Material	Colour	Finish
TINA2-XP-D	Single lens	PMMA	clear	
TINA2-XP-HLD-TAPE-BLK	Holder	PC	black	
TINA-TAPE3	Tape	PU tape	black	

### ORDERING INFORMATION:

Component		Qty in box	MOQ	MPQ	Box weight (kg)
CA11420_TINA2-D	Single lens	4140	230	230	8.8
» Box size: 451 x 241 x 298 mm					



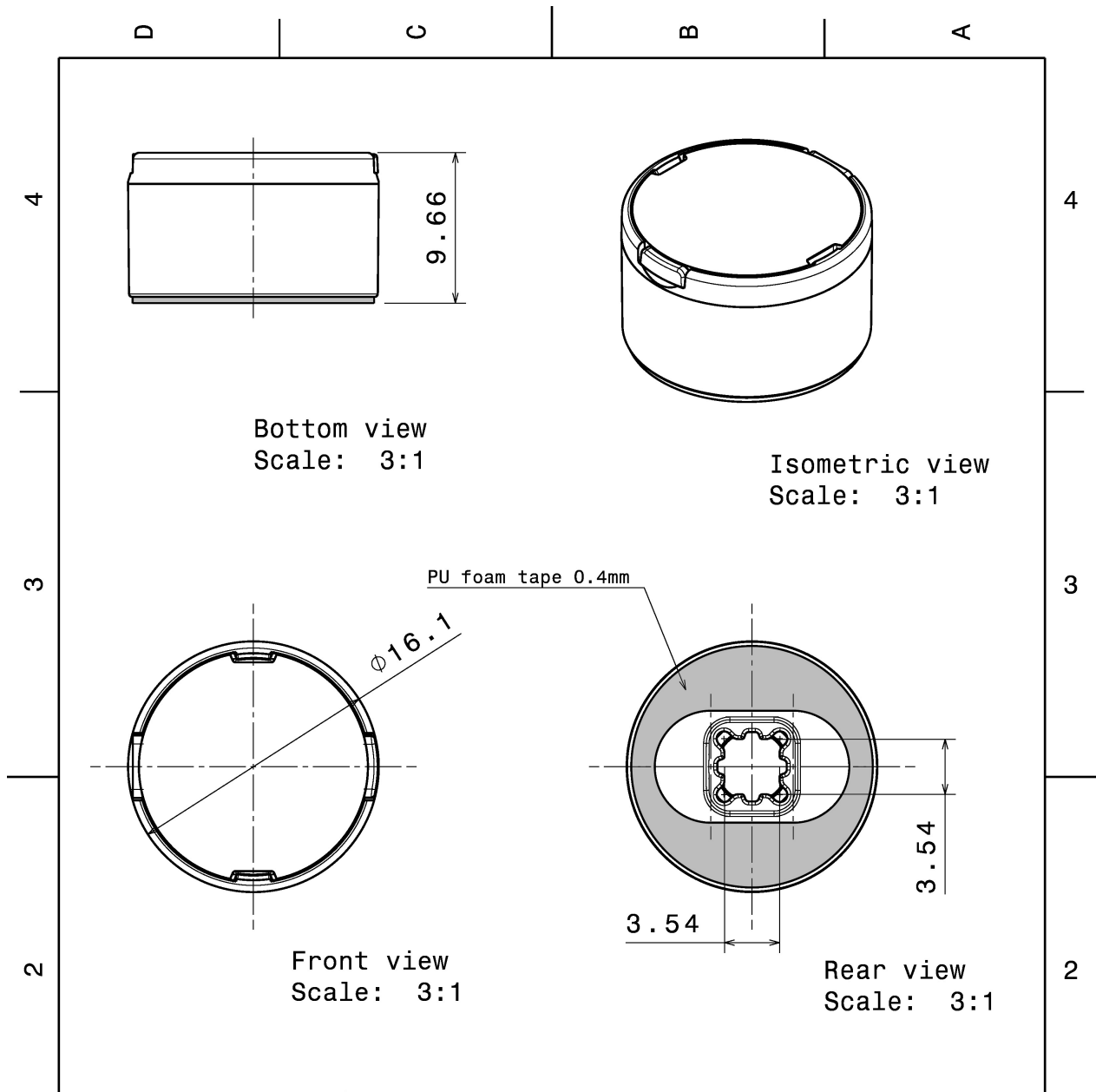

INDEX	PART NO	DESCRIPTION	MATERIAL	COLOUR
1	-	TINA2-lens	PMMA	
2	C11418	TINA2-XP-HLD-TAPE-BLK	PC	black

Tolerances if not otherwise shown  
According to DIN ISO 2768-1  
Linear measures:  
Up to 30mm class M, otherwise class C.  
According to DIN ISO 2768-2  
Form and position: class L

**LEDiL**

Ledil Oy  
Salorankatu 10  
FIN 24240 SALO  
Finland

THIRD ANGLE PROJECTION:



DRAWING TITLE  
**TINA2-XP-series assembly**

This drawing is the property of LEDiL Oy. It may not be reproduced, copied or communicated without a written agreement with LEDiL Oy.

SIZE	PART NUMBER
A4	-

SCALE	3:1	WEIGHT	1,3 g	SHEET	1/1
-------	-----	--------	-------	-------	-----

#### PHOTOMETRIC DATA (MEASURED):

#### CREE

LED XP-E  
 FWHM 12.0°  
 Efficiency 91 %  
 Peak intensity 10.3 cd/lm  
 LEDs/each optic 1  
 Light colour White  
 Required components:

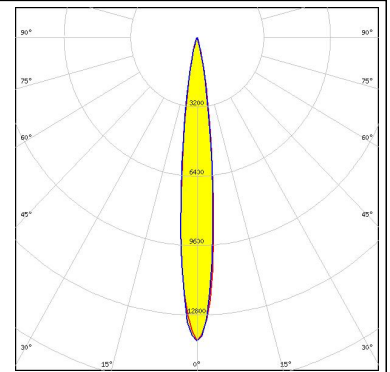

#### CREE

LED XP-E2  
 FWHM 13.0°  
 Efficiency 86 %  
 Peak intensity 11.8 cd/lm  
 LEDs/each optic 1  
 Light colour White  
 Required components:

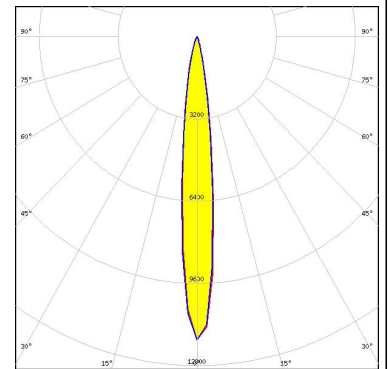

#### CREE

LED XP-G  
 FWHM 17.0°  
 Efficiency 91 %  
 Peak intensity 5.5 cd/lm  
 LEDs/each optic 1  
 Light colour White  
 Required components:

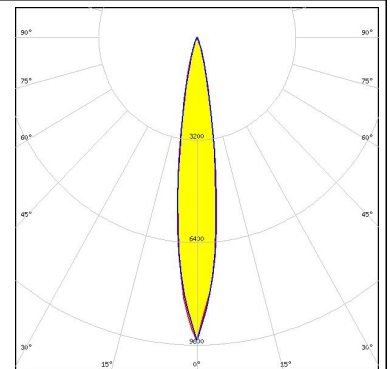

#### CREE

LED XP-G2  
 FWHM 15.0°  
 Efficiency 90 %  
 Peak intensity 8 cd/lm  
 LEDs/each optic 1  
 Light colour White  
 Required components:

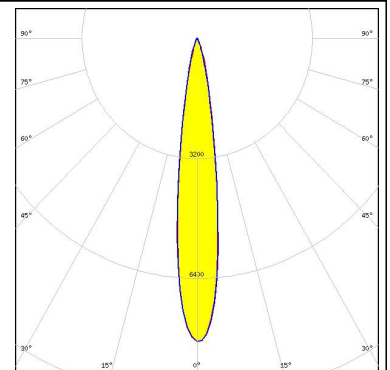

### PHOTOMETRIC DATA (MEASURED):

**CREE** 

LED XT-E  
FWHM 16.0°  
Efficiency %  
Peak intensity 6.2 cd/lm  
LEDs/each optic 1  
Light colour White  
Required components:

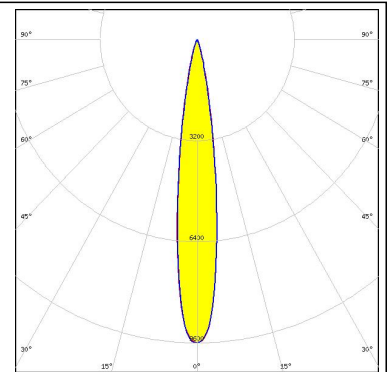

 **LG Innotek**

LED H35C1 (LEMWA33)  
FWHM 17.0°  
Efficiency 86 %  
Peak intensity 7.2 cd/lm  
LEDs/each optic 1  
Light colour White  
Required components:

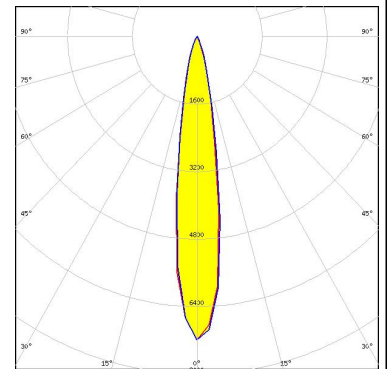

### PHOTOMETRIC DATA (SIMULATED):

**CREE** 

LED XD16  
FWHM 13.0°  
Efficiency 87 %  
Peak intensity 11.3 cd/lm  
LEDs/each optic 1  
Light colour White  
Required components:

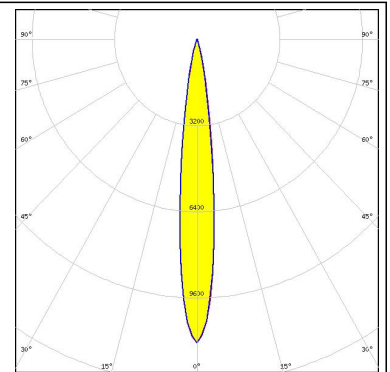

**CREE** 

LED XP-G2 HE  
FWHM 18.0°  
Efficiency 80 %  
Peak intensity 5.9 cd/lm  
LEDs/each optic 1  
Light colour White  
Required components:

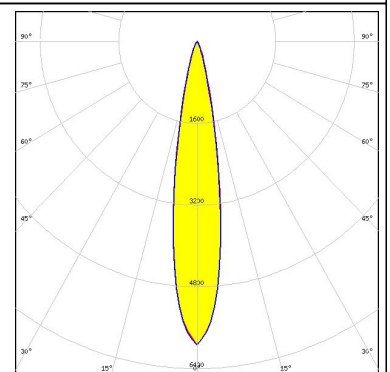

### GENERAL INFORMATION:

NOTE: The typical beam angle will be changed by different color, chip size and chip position tolerance. The typical total beam angle is the full angle measured where the luminous intensity is half of the peak value.

### MATERIALS:

As part of our continuous research and improvement processes, and to ensure the best possible quality and availability of our products, LEDiL reserves the right to change material grades without notice.

### PRODUCT DATA USER AGREEMENT AND DISCLAIMER:

The measured data in the provided downloadable LEDiL Product Datasheets and Mechanical 2D-Drawings is rounded and provided as reference for planning. LEDiL Oy's optical specifications have been verified by conducting performance testing of the products in accordance with the company's quality system. The reported data are averaged results of multiple measurements with typical variation. LEDiL Oy reserves the right to without prior notification make changes and improvements to its products.

LEDiL Oy assumes neither warranty, nor guarantee nor any other liability of any kind for the contents and correctness of the provided data. The provided data has been generated with highest diligence but the provided data may in reality not represent the complete possible variation range of all intrinsic parameters. Therefore, in certain cases a deviation from the provided data could occur.

LEDiL Oy reserves the right to undertake technical changes of its products without further notification which could lead to changes in the provided data. LEDiL Oy assumes no liability of any kind for the possible deviation from any provided data or any other damage resulting from the usage of the provided data.

The user agrees to this disclaimer and user agreement with the download or usage of the provided files.

#### LEDiL Oy

Joensuunkatu 13  
FI-24240 SALO  
Finland

#### LEDiL Inc.

228 West Page Street  
Suite D  
Sycamore IL 60178  
USA

#### Local sales and technical support

[www.ledil.com/  
where\\_to\\_buy](http://www.ledil.com/where_to_buy)

#### Shipping locations

Salo, Finland  
Hong Kong, China

#### Distribution Partners

[www.ledil.com/  
where\\_to\\_buy](http://www.ledil.com/where_to_buy)