

STRADA-T-DW

Soft wide beam with good illuminance
uniformity optimized for CREE XP-G and XP-E

TECHNICAL SPECIFICATIONS:

Dimensions	19.6 x 15.5 mm
Height	10.7 mm
Fastening	pin, screw
ROHS compliant	yes ⓘ

MATERIAL SPECIFICATIONS:

Component	Type	Material	Colour	Finish
STRADA-T-DW	Single lens	PMMA	clear	

ORDERING INFORMATION:

Component	Qty in box	MOQ	MPQ	Box weight (kg)
C11425_STRADA-T-DW » Box size: 480 x 280 x 300 mm	2880	288	144	5.1



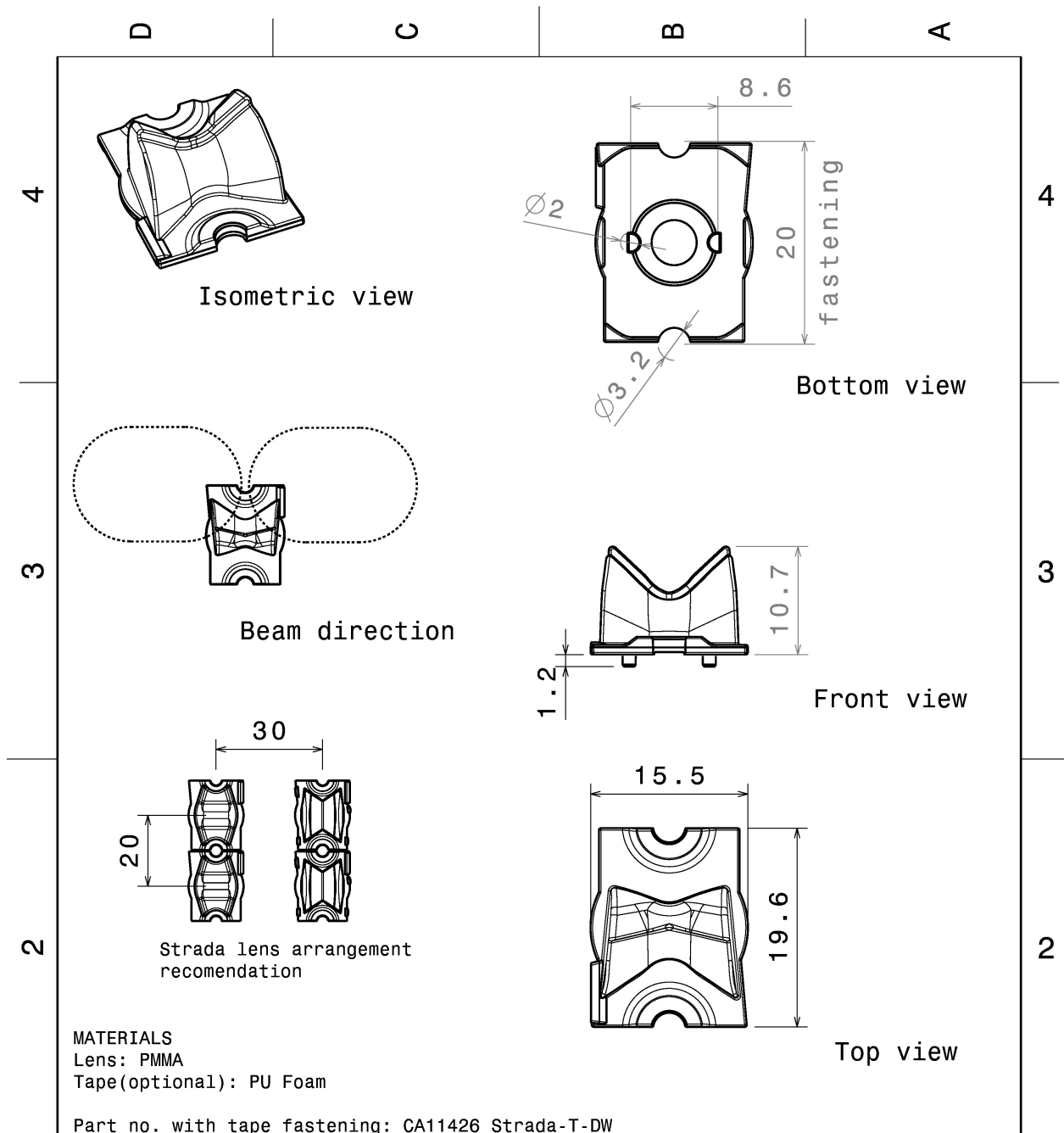

This drawing is our property. It can't be reproduced or communicated without our written agreement.		<p>Ledil Oy Tehdaskatu 13 FIN-24100 SALO Finland</p>	
DRAWING TITLE			
DRAWN BY o1	DATE 17.05.2010	Datashet Strada-T-DW Lens	
CHECKED BY pv	DATE 17.05.2010	SIZE A4	DRAWING NUMBER C11425
DESIGNED BY hh	DATE 17.05.2010	SCALE 2:1	WEIGHT (g)
		SHEET	1/1

PHOTOMETRIC DATA (MEASURED):



LED XP-E
FWHM Asymmetric
Efficiency 93 %
LEDs/each optic 1
Light colour White
Required components:

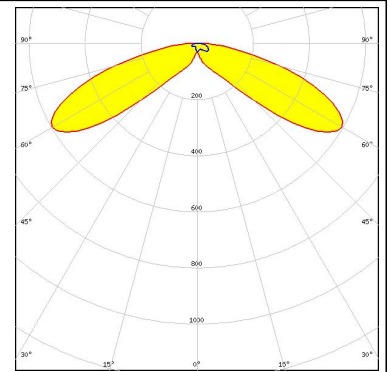

LED XP-G
FWHM Asymmetric
Efficiency 93 %
LEDs/each optic 1
Light colour White
Required components:

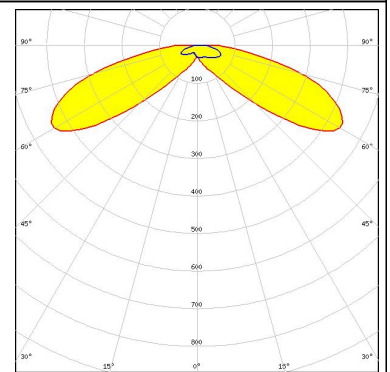

LED LUXEON A
FWHM Asymmetric
Efficiency 93 %
LEDs/each optic 1
Light colour White
Required components:



LED LUXEON Rebel
FWHM Asymmetric
Efficiency 93 %
LEDs/each optic 1
Light colour White
Required components:

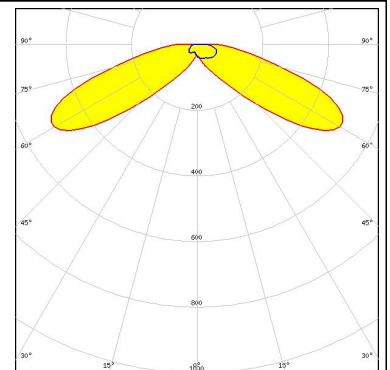

PHOTOMETRIC DATA (MEASURED):



LED LUXEON Rebel ES
FWHM Asymmetric
Efficiency 93 %
LEDs/each optic 1
Light colour White
Required components:

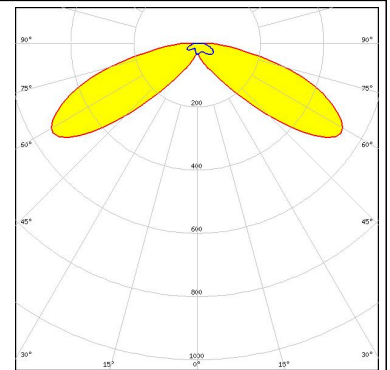

LED NCSxx19A
FWHM Asymmetric
Efficiency 93 %
LEDs/each optic 1
Light colour White
Required components:



LED NVSxx19A
FWHM Asymmetric
Efficiency 93 %
LEDs/each optic 1
Light colour White
Required components:



LED OSLOM Square PC
FWHM Asymmetric
Efficiency 92 %
LEDs/each optic 1
Light colour White
Required components:

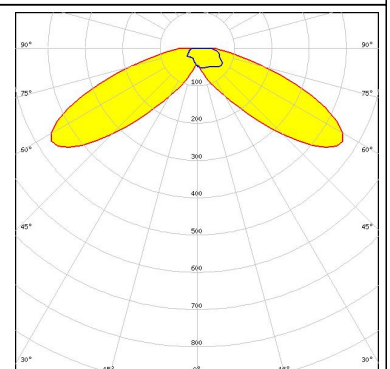

PHOTOMETRIC DATA (MEASURED):

OSRAM Opto Semiconductors

LED OSLON SSL 150
FWHM Asymmetric
Efficiency 93 %
LEDs/each optic 1
Light colour White
Required components:

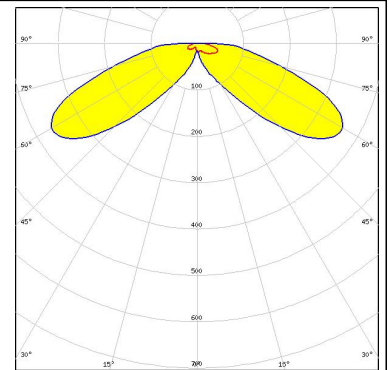

OSRAM Opto Semiconductors

LED OSLON SSL 80
FWHM Asymmetric
Efficiency 93 %
LEDs/each optic 1
Light colour White
Required components:

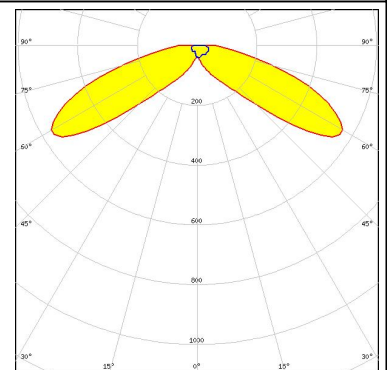

SEMI SEOUL SEMICONDUCTOR

LED Z5
FWHM Asymmetric
Efficiency 93 %
LEDs/each optic 1
Light colour White
Required components:

SHARP

LED Double Dome (GM2BB)
FWHM Asymmetric
Efficiency 93 %
LEDs/each optic 1
Light colour White
Required components:

GENERAL INFORMATION:

NOTE: The typical beam angle will be changed by different color, chip size and chip position tolerance. The typical total beam angle is the full angle measured where the luminous intensity is half of the peak value.

MATERIALS:

As part of our continuous research and improvement processes, and to ensure the best possible quality and availability of our products, LEDiL reserves the right to change material grades without notice.

PRODUCT DATA USER AGREEMENT AND DISCLAIMER:

The measured data in the provided downloadable LEDiL Product Datasheets and Mechanical 2D-Drawings is rounded and provided as reference for planning. LEDiL Oy's optical specifications have been verified by conducting performance testing of the products in accordance with the company's quality system. The reported data are averaged results of multiple measurements with typical variation. LEDiL Oy reserves the right to without prior notification make changes and improvements to its products.

LEDiL Oy assumes neither warranty, nor guarantee nor any other liability of any kind for the contents and correctness of the provided data. The provided data has been generated with highest diligence but the provided data may in reality not represent the complete possible variation range of all intrinsic parameters. Therefore, in certain cases a deviation from the provided data could occur.

LEDiL Oy reserves the right to undertake technical changes of its products without further notification which could lead to changes in the provided data. LEDiL Oy assumes no liability of any kind for the possible deviation from any provided data or any other damage resulting from the usage of the provided data.

The user agrees to this disclaimer and user agreement with the download or usage of the provided files.

LEDiL Oy

Joensuunkatu 13
FI-24240 SALO
Finland

LEDiL Inc.

228 West Page Street
Suite D
Sycamore IL 60178
USA

Local sales and technical support

[www.ledil.com/
where_to_buy](http://www.ledil.com/where_to_buy)

Shipping locations

Salo, Finland
Hong Kong, China

Distribution Partners

[www.ledil.com/
where_to_buy](http://www.ledil.com/where_to_buy)